

THIS DOCUMENT IS SUBJECT TO CHANGE WITHOUT NOTICE. IT IS CONFIDENTIAL AND A PROPERTY OF Amphenol LTW. DISCLOSURE TO THIRD PARTY HAS TO BE AUTHORIZED BY Amphenol LTW.

REV.	ECN NO.	DATE	SIGN	DESCRIPTION
A	Initial Release	2015/07/25	Feng_Li	Change Rev.01 To Rev.A
B	LEN16A0103-105	2016/10/14	Yulong_wang	Add 3, 5Pin, IP69K & Cat5e Cable.

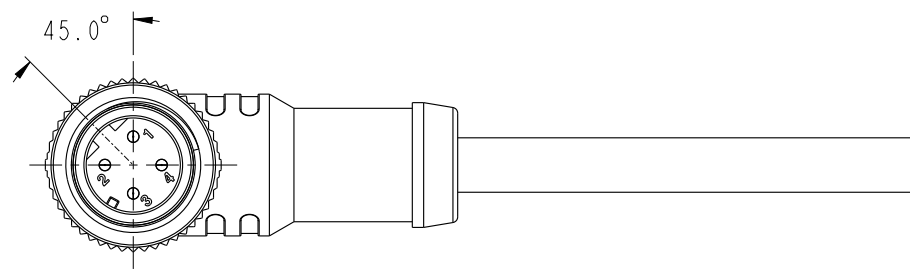
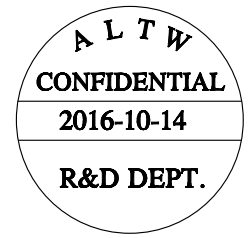
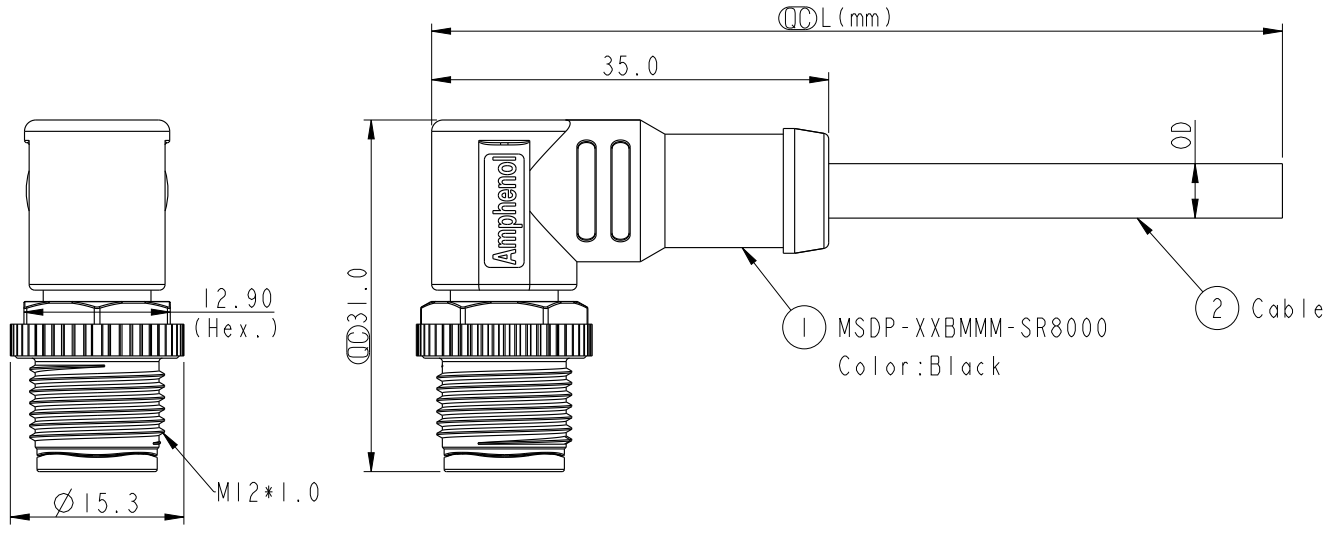

- Notes:
- \*  $\varnothing$  Important Dimension.
  - $\triangle A$ \* Waterproof Rate: IP68, IP69K.
  - \* Connector: PU+GF, Black.
  - \* Male Pin: Copper Alloy, Gold Plated.
  - \* Screw Nut: Nylon, Black.
  - \* Outer Mold: PU, Black.
  - $\triangle B$ \* Cable: (A) UL2517, PVC Jacket, Yellow.  
(B) UL20549, PUR Jacket, Black.  
(D) UL2517, PVC Jacket, Black.  
(E) CAT5E, PU Jacket, Black.
  - $\triangle B$ \* Rated Voltage: 3 & 4Pin 250V dc. or ac.  
5Pin 60V dc. or ac.
  - \* Rated Current: 4A
  - \* Operating Temperature: -25~+85°C
  - \* Cable Length Tolerance: 01M:±40mm  
02M~05M:±60mm  
06M~10M:±100mm  
11M~30M:±200mm  
31M~99M:±500mm

UNIT:mm		
TOLERANCE		
±0.5mm		

TITLE		
M12 D Type Cable 90° Male Conn.		
SCALE	SIZE	SHEET
3:2	A4	1 OF 2
REV.	WC-REV.	$\varnothing$ : Inspection item
B	A.2	

**Amphenol LTW**  
安費諾亮泰企業股份有限公司

ITEM NO	DRAWN BY	DATE
	Yulong_wang	2016-10-14
DWG NO	CHECKED BY	DATE
MSDP-XXBMMM-SR8XXX	Jinhai	2016-10-14
CUSTOMER	APPROVED BY	DATE
ALTW	Jerry	2016-10-14

THIS DOCUMENT IS SUBJECT TO CHANGE WITHOUT NOTICE. IT IS CONFIDENTIAL AND A PROPERTY OF Amphenol LTW. DISCLOSURE TO THIRD PARTY HAS TO BE AUTHORIZED BY Amphenol LTW.

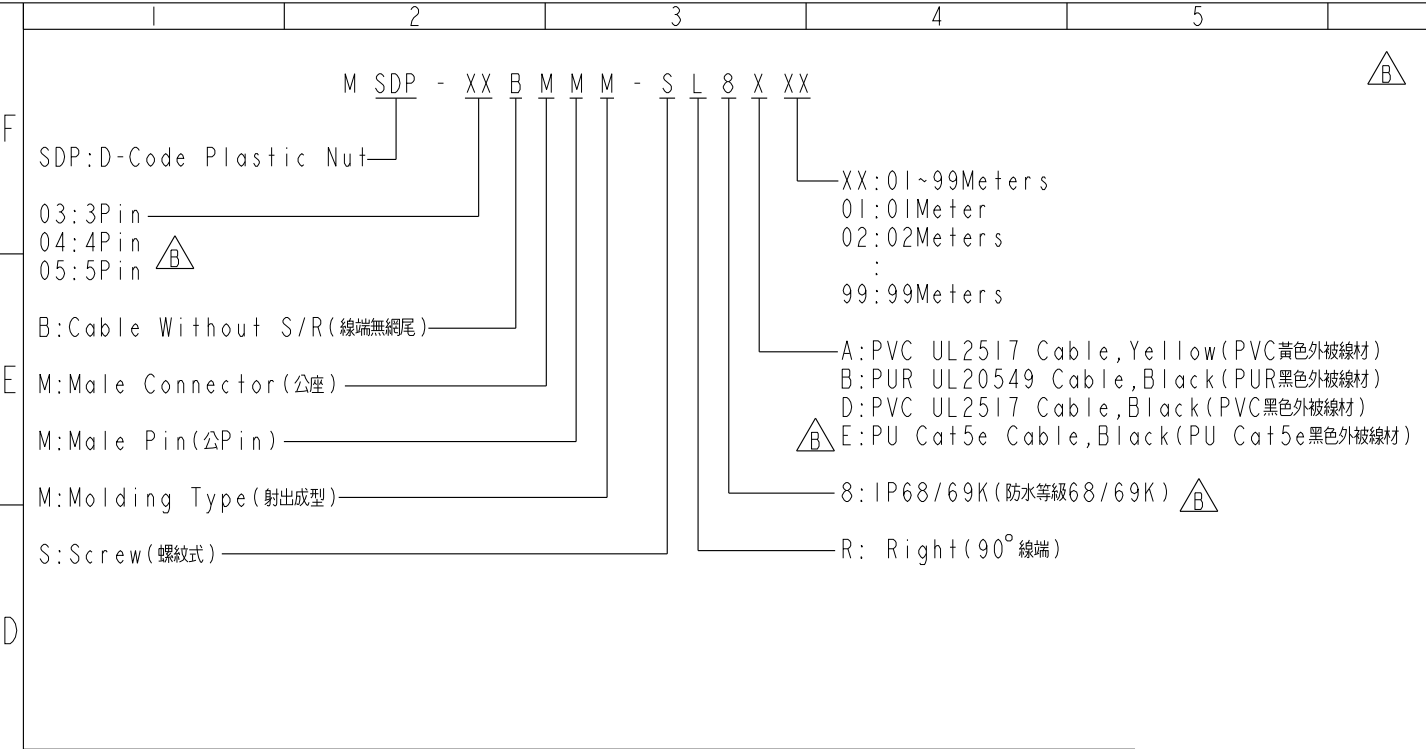

4P	PU	6.2	22	MSDP-04BMMM-SR8EXX
5P	PVC	5.1		MSDP-05BMMM-SR8DXX
4P		4.8		MSDP-04BMMM-SR8DXX
3P		4.5		MSDP-03BMMM-SR8DXX
5P	PUR	4.4		MSDP-05BMMM-SR8BXX
4P		4.0		MSDP-04BMMM-SR8BXX
3P	PVC	3.8		MSDP-03BMMM-SR8BXX
5P		5.1		MSDP-05BMMM-SR8AXX
4P		4.8		MSDP-04BMMM-SR8AXX
3P	4.5	MSDP-03BMMM-SR8AXX		
Contacts	Cable Jacket	Cable OD	AWG	Item No.

5	--	5	--	5	Gray	灰		
4	Black	4	Black	4	Black	黑	4	Green
3	Blue	3	Blue	3	Blue	藍	2	White/Green
2	--	2	White	2	White	白	3	Orange
1	Brown	1	Brown	1	Brown	棕	1	White/Orange
Pin #	Wire	Pin #	Wire	Pin #	Wire		Pin #	Wire (Cat5e)

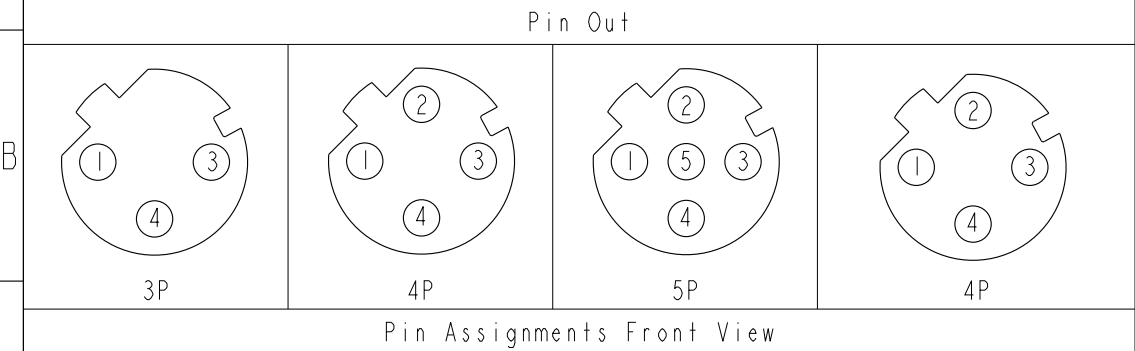
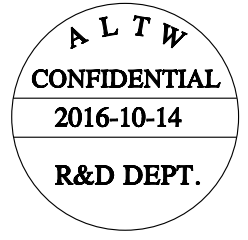
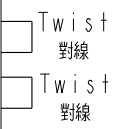

UNIT: mm TOLERANCE ±0.5mm	TITLE M12 D Type Cable 90° Male Conn.		Amphenol LTW 安費諾亮泰企業股份有限公司		ITEM NO	DRAWN BY Yulong_wang	DATE 2016-10-14
	SCALE 3:2	SIZE A4			SHEET 2 OF 2	DWG NO MSDP-XXBMMM-SR8XXX	CHECKED BY Jinhai
	REV. B	WC-REV. A.2	☉: Inspection item		CUSTOMER ALTW	APPROVED BY Jerry	DATE 2016-10-14

## X-ON Electronics

Largest Supplier of Electrical and Electronic Components

*Click to view similar products for [Sensor Cables / Actuator Cables](#) category:*

*Click to view products by [Amphenol](#) manufacturer:*

Other Similar products are found below :

[60963](#) [60964](#) [M83513/19-F01CP](#) [703000D02F2002](#) [703001D02F0602](#) [703001D02F300](#) [704000D02F120](#) [773032K02F030](#) [802027107404-1](#)  
[802027213811-1](#) [804001A09M150](#) [805001A09M0502](#) [84914-0235](#) [84914-0237](#) [885030A09M020](#) [8R4J30E03C3003](#) [1200651332](#)  
[1200651713](#) [1200660844](#) [1200660845](#) [1200661173](#) [1200680071](#) [1200720053](#) [1200720081](#) [1200720099](#) [1200720217](#) [1200800231](#)  
[1200860125](#) [1200870123](#) [1200980102](#) [1200650267](#) [1200650298](#) [1200660183](#) [1200660782](#) [1200660849](#) [1200661295](#) [1200661297](#)  
[1200661342](#) [1200661343](#) [1200670080](#) [1200670220](#) [1200680331](#) [1200720252](#) [1200730184](#) [1200860344](#) [1200870359](#) [1200870643](#)  
[1200980008](#) [1200980031](#) [1210502211](#)