

SIGN	DATE	DESCRIPTION	APPROVER
△	10/20'05	Dim changed from 3.8 to 3.5	Marvin
△	04/20'06	Added feature	Marvin
△	8/16'06	Added VDE standard	Steady
△	1/12'07	Soldering temperature changed from 245° to 250°	Tony
△	5/27'08	Operating temperature is changed	Marvin
△	2009.08.18	The material is changed	Jacke
△	2010.07.07	Remove the CSA mark	Chen Bo
△	2010.12.21	Dim changed from 2.6 to 2.5	Runner
△	2012.05.22	Voltage rating is changed	Chen Bo
△	08/28-15	Add the product number	Evan

THIS IS CAD DRAWING, DO NOT REVISE MANUALLY!!!

DIMENSION



A	$(N-1) \times 3.81 + 5.0$
B	$(N-1) \times 3.81$

N= number of poles

Poles	Tolerance
2P-6P	±0.15
7P-12P	±0.20
13P-18P	±0.25
19P-24P	±0.30

Material:

- Item ③ Male contact pin: Copper C1100 Tin plated
- Item ④ Terminalhousing: Thermoplastic (UL94V-0)

- △ 3 Electrical: cULus /VDE
- △ 9 ● Voltage rating: 300V/300V
- Current rating: 10A/10.5A
- Withstanding Voltage: 1.6 KV/2.5KV
- △ 5 ● Operating temperature: -40°C to +115°C
- △ 4 ● Soldering temperature: 250°C±10°C/5 Sec
- △ 1 ● Safety Approval:  
- Critical dimension: ∇

OQ xx 3 2 x 1 xxxx G

No. OF POLES
02: 2 POLES
:
24: 24 POLES

- COLOR
- 0 Black (RAL9005)
 - 2 Red (RAL3001/D)
 - 3 Orange(RAL2011/P)
 - 4 Yellow(RAL1018/A)
 - 5 Green(RAL6018/T)
 - 6 Blue (RAL5015/A)
 - 8 Grey(RAL7035/D)
 - 9 White(RAL1102)
 - C Green(RAL6018/U)
- G RoHS compliant (lead<4%)
In copper Alloy
- 0000: "@" Logo (Standard)
000A: "ANYTEK" Mark
0091: "ANYTEK" Mark △
- Any special item by customer request.
please contact sales department.

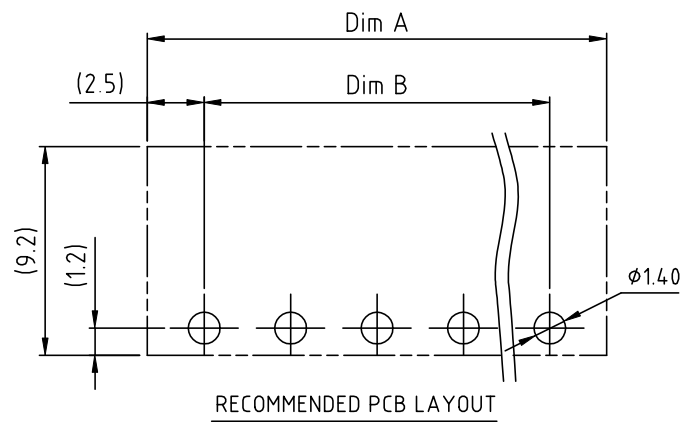
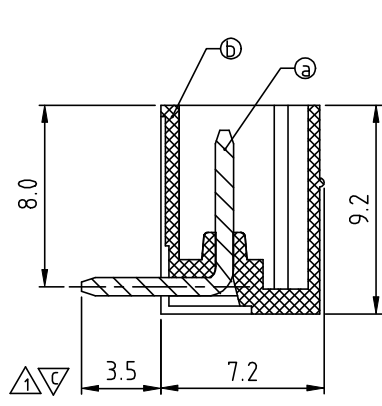
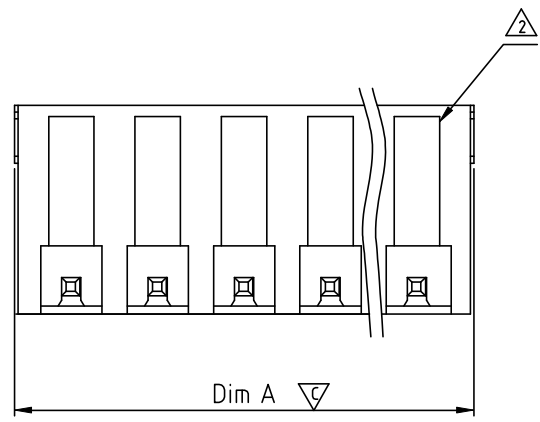
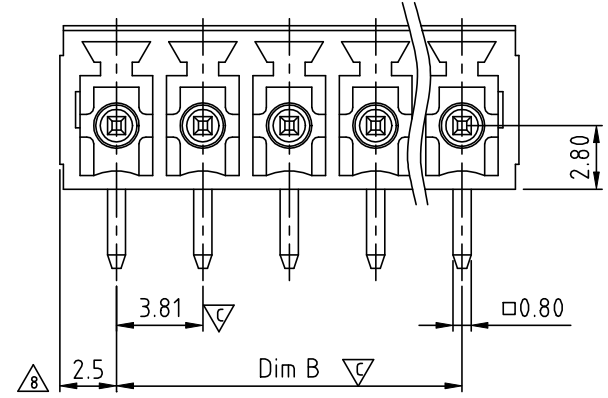

RECOMMENDED PCB LAYOUT

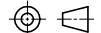
ANYTEK				CUSTOMER COPY			
ALL RIGHTS RESERVED. REPRODUCTION OR ISSUE TO THIRD PARTIES IN ANY FORM WHATSOEVER IS NOT PERMITTED WITHOUT WRITTEN AUTHORITY FROM THE PROPRIETOR. PROPERTY OF ANYTEK TECHNOLOGY CO., LTD							
TITLE		OQ 3.81mm Series 90° (2P-24P) Triangle Key Lock					
PART NO.		OQxx32x1xxxxG		DWG NO.		80Q0602	
APPROVED	CHECKED	DESIGNED	DRAWN	CUST NO.		Tolerance	
		Evan	Chen Bo			X. ±0.50	
		08/28-15	05/23-12			UNIT: mm	
				SHEET: 01/01		SCALE: NONE	
				REV.: M		X.XX ±0.10	
						X° ±1°	

X-ON Electronics

Largest Supplier of Electrical and Electronic Components

Click to view similar products for [Pluggable Terminal Blocks](#) category:

Click to view products by [Amphenol](#) manufacturer:

Other Similar products are found below :

[57.510.0053](#) [721-104/026-047](#) [721-204/026-045](#) [MC 1.5/ 6-ST-3.5 GY AU](#) [ET02015000J0G](#) [860505](#) [860516](#) [860810](#) [GBPACX-12](#)
[93.731.4953.0](#) [PVP03-3,50](#) [PVS02-5,00](#) [1-1986160-3](#) [1377680000](#) [1531000000](#) [1546228-5](#) [ELFP03110](#) [ELFP10210](#) [ELFT07250](#)
[ELVD12100](#) [ELVF09400](#) [ELXH071G0E](#) [1725220000](#) [1760336](#) [1855000000](#) [19346](#) [1946309](#) [1973592](#) [19892](#) [25.320.4053.1](#) [25.320.4553.9](#)
[25.320.4753.1](#) [25.320.5453.1](#) [25.340.0353.1](#) [25.340.1053.1](#) [25.345.3553.0M001](#) [25.640.3553.1](#) [SH02-5,08](#) [SH06-3,81](#) [SH08-5,08](#) [SH08-](#)
[5,08-K](#) [SH12-5,08](#) [SHS04-5,00](#) [30.303](#) [30.305](#) [30.306](#) [PHP09-5,08](#) [25.193.0453.0](#) [25.320.4653.1](#) [25.332.2453.1](#)