



pulseOne cable assemblies are ready-made to meet your exacting specifications.

When longevity is required, **pulseOne's** robust standard configuration ensures durability in repeated-use applications. Whether sterilized by EtO, or disinfected with standard hospital cleaning agents, **pulseOne** continues to perform after reprocessing.

Yet for applications best served by disposable products, **pulseOne's** "Limited Use" alternative is an ideal choice. Select this option to get great performance at the right price.

And if intelligent solutions are needed, **pulseOne's** factory installed PCB option* allows you to program in limits to the number of uses, proper OEM identification and other 'smart' features.



installed PCB option* allows you to program in limits to the number of uses, proper OEM identification and other 'smart' features.

* Available soon

FEATURES & BENEFITS

- ▶ **Pre-molded to Cable**
Performance matched cable with connector simplifies the specification process
- ▶ **Tactile & Audible Confirmation of Mate**
Assurance that the connector is mated properly
- ▶ **"D" Shape Friction Fit Design**
Easy to align and connect in blind mate applications. Simply pull to disconnect
- ▶ **Touch Proof Contacts¹** 1 - Per IEC-60601-1
Protects against accidental touch in multiple keying options
- ▶ **Sealed to IP-64 and IP-67²** 2 - IP-67 applies to panel mount receptacle only
Keeps water and cleaning agents out of the connector when mated
- ▶ **Optional Active Components**
Properly identify and control single use or variable device parameters



APPLICATION EXAMPLES

- ▶ **Surgical Devices**
The "Limited Use" option is perfect for disposable electrosurgical products
- ▶ **Vital Sign Monitoring Devices**
Simple to use and small size make pulseOne great for patient wearable products
- ▶ **Therapy Delivery Devices**
Easily connect to electrodes for a wide array of single use applications





STANDARD CONNECTOR OPTIONS

Plug Cable Assemblies

- 4, 7, 10, and 14 pin options available
- Unshielded or Shielded
- Up to 3 keyways standard
- PCB Option (future)

Note: For custom cables, cable lengths, colors and keys available, please consult factory

Receptacle Assemblies

- Cable Mount or Panel Mount
- 4, 7, 10, and 14 pin options
- Unshielded or Shielded
- Up to 3 keyways standard

BASIC DIMENSIONS

Inches (mm)

Cable-mount plug

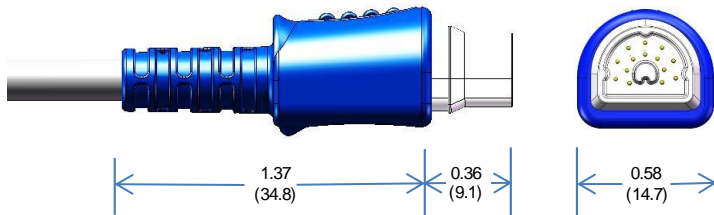

Cable-mount receptacle

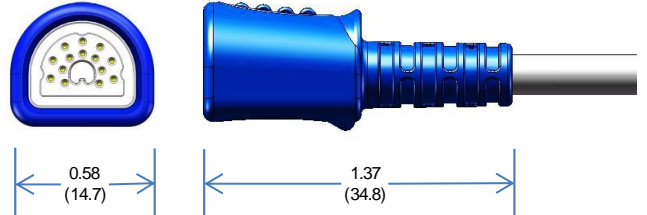

Rear panel-mount (RPM) receptacle

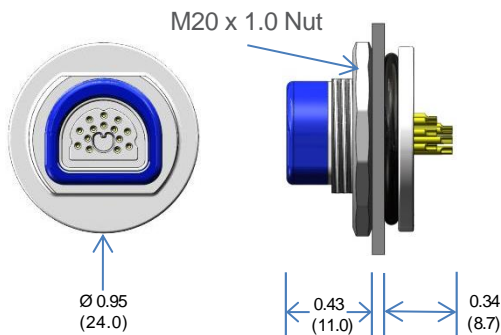

Front panel-mount (FPM) receptacle

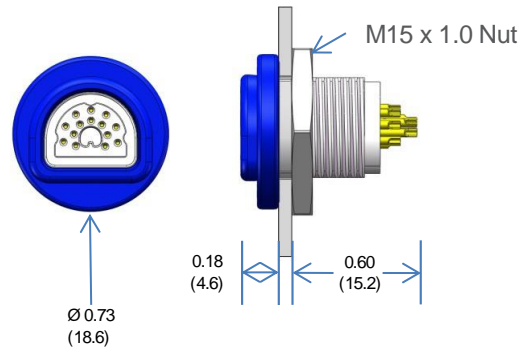

RPM panel cutout

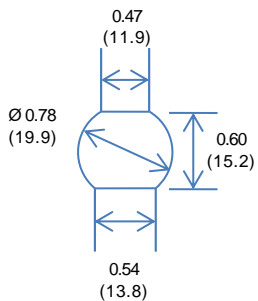

FPM panel cutout

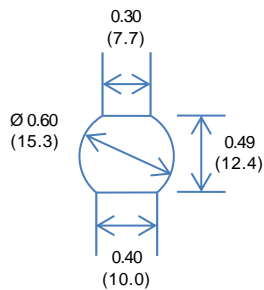

Pin ID View

Note: Cable side of the receptacle shown

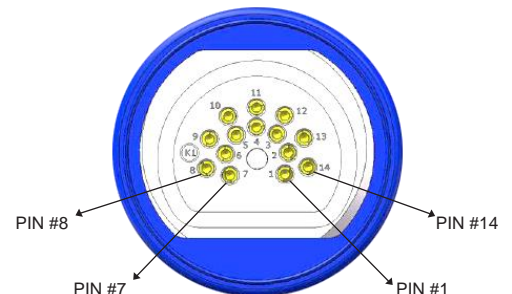



HOW TO ORDER / PART NUMBER

PulseOne is available in a variety of standard configurations as well as an infinite number of custom possibilities. Standard contacts are arrayed in a semi-circular pattern in 4, 7, 10 and 14 poles with 3 choices for keying. Each connector is assembled and molded onto a standard cable, one meter in length. For custom cable, shielded connectors, and plugs with programmable PCB's, please consult the factory.

		Part Number: P1 P N L 04 B 1 N 1000 - YYYY									
Connector Body	Plug	P									
	Receptacle	R									
	Non-Shielded		N								
	Shielded		S								
Mating Cycles	Limited Use (< 100 mating cycles) - plug only			L							
	Multiple Use - up to 5,000 mating cycles			M							
Number of Contacts	4 pole				04						
	7 pole				07						
	10 pole				10						
	14 pole				14						
Color	Blue - standard					B					
	Gray					G					
	Custom Color - requires suffix					C					
Key 1	Key 1 standard						1				
	Key 2						2				
	Key 3						3				
	Custom Key - requires suffix						C				
Mount To	Standard Cable - no shield							N			
	Standard Cable - with shield							S			
	Custom Cable - requires suffix							C			
	Front Panel Mount - no cable							F			
	Rear Panel Mount - no cable							R			
	Cable Length (millimeters) - 1,000 and 2,000 mm standard									XXXX	
Custom	Suffix to be assigned by Amphenol Alden										YYYY

CIRCUIT CONFIGURATIONS



4 Pole
Key 1
Plug Face



7 Pole
Key 1
Plug Face



10 Pole
Key 1
Plug Face



14 Pole
Key 1
Plug Face



TECHNICAL SPECIFICATIONS

Mechanical

Mating Cycle Durability:	per EIA-364-26
Receptacle	> 5,000
Plug, Limited use	< 100
Plug, Multiple use	> 5,000
Mating Forces (N):	per EIA-364-13
Insertion:	31
Withdrawal:	23
Flex Cycles:	+/- 90 degrees
Cable unshielded	> 5,000 one axis
Cable shielded	> 2,500 one axis
Panel Nut Torque Spec:	4.5 kgf-cm

Environmental

Mated Plug to In-line Receptacle Seal to IP-64
Mated Plug to Panel Mount Receptacle Seal to IP-67
Disinfect with standard hospital cleaning agents
Sterilize with EtO

Electrical

Operating Current:	1.0A per contact, continuous duty, $\leq 30^{\circ}\text{C}$ temperature rise, all 14 contacts energized, per EIA-364-70
Operating Voltage:	300 V RMS per EIA-364-20
DWV – Pin to Pin:	1,000 VDC @ 100 microamps leakage max per EIA-364-20
DWV – Pins to Ground:	5,000 VDC @ 100 microamps leakage max per EIA-364-20

Component Materials

Standard Cable:	28AWG stranded cond. PVC insulated, TPU jacket, non shielded, color natural (off white)
Contacts:	Copper alloy with gold over nickel plate
Connector Housing:	Polyamide, color white
Overmolds:	TPU, color blue

THE AMPHENOL ADVANTAGE

No other interconnect manufacturer can match our special knowledge, collaborative engineering expertise, the flexibility to quickly customize our standard product, and the power of Amphenol's global manufacturing capabilities to serve the demands of the global market.

Amphenol Alden is designed to be your complete interconnect resource regardless of your interconnect need. From simply providing world-class connectors, to engineering and manufacturing the most complex final overmolded cable and electronic accessory, only Amphenol Alden merges design engineering, product and process expertise to deliver interconnect results that are as ergonomic and effective as they are economical.

Amphenol Alden is located in Brockton, Massachusetts, at 117 N. Main Street. Visit us on the web at www.amphenolalden.com or call us at 508-427-7000 for more information and to discuss your specific application in detail.

X-ON Electronics

Largest Supplier of Electrical and Electronic Components

Click to view similar products for [Specialised Cables category](#):

Click to view products by [Amphenol manufacturer](#):

Other Similar products are found below :

[603PT6](#) [603SS6L](#) [604PT6](#) [604SS6](#) [706000D02F200](#) [910640](#) [1200740077](#) [1200740114](#) [AC172](#) [ACL-SSI-4](#) [R88ACAKA0015SRE](#)
[R88ACAWL005SDE](#) [R88ACRGD0R3C](#) [1300150047](#) [1300660036](#) [1302262116](#) [1300150149](#) [1300220020](#) [1300220104](#) [1300220119](#)
[1301240492](#) [1301810221](#) [1365323-1](#) [176P12](#) [1971465-2](#) [20240400003](#) [20240400013](#) [2085828-1](#) [20886510030](#) [2-22733-8](#) [22733-8](#) [CB-](#)
[5PSBC-RS](#) [CB-704EC-RS](#) [CB-BATACC-RS](#) [CB-JST3PSW-RS](#) [CB-M12COM-R10](#) [25AC84](#) [25AK84X](#) [25AU25](#) [25FN82](#) [3011-03](#) [AC118](#)
[ACL-HHS-1M\(CAT5E\)](#) [SSL009PC2DC012N](#) [FC2A-KC6C](#) [2085828-2](#) [20886510150](#) [CCS-FCB-5](#) [CCSF CBF2](#) [R88A-CRWB020N](#)