

Factory Automation

Distributed Power & Control



PowerBOSSlite™ M35 (1 $\frac{3}{8}$ "), PowerBOSSlite™ M22 ($\frac{7}{8}$ "), PowerBOSS™ M40 featuring Checkmate™
PowerBOSS™ M40, PowerBOSS™, ControlBOSS™, VersaBOSS™ - FC Hybrid, MC, Powerflex
ControlPower, miniBOSS™ M22 ($\frac{7}{8}$ "), microBOSS™ M12 ($\frac{1}{2}$ "), DeviceNet, Ethernet M12

Table of Contents

| | |
|---|-----|
| We Are Amphenol | 1 |
| Standard Products. Custom Solutions..... | 2 |
| Product Overviews..... | 3 |
| Why and Where? | 7 |
| Installation Considerations | 9 |
| Architectural Layouts..... | 11 |
| PowerBOSSlite™ M35 (1 ³ / ₈ ") | 14 |
| PowerBOSSlite™ M22 (7/ ₈ ") | 26 |
| PowerBOSS™ M40 featuring Checkmate™ | 32 |
| PowerBOSS™ M40..... | 42 |
| PowerBOSS™ | 46 |
| ControlBOSS™ | 58 |
| VersaBOSS™ - FC Hybrid | 72 |
| VersaBOSS™ - MC | 76 |
| VersaBOSS™ - Powerflex | 80 |
| ControlPower..... | 84 |
| miniBOSS™ M22 (7/ ₈ ") | 88 |
| microBOSS™ M12 (1/ ₂ ") | 92 |
| DeviceNet..... | 96 |
| Ethernet..... | 102 |
| Index..... | 106 |



We are Amphenol.

Global Interconnect Solution Supplier

For over 80 years Amphenol has enjoyed success as the interconnection technology provider of choice to industry leading companies around the world. Our organization works with leading manufacturers across a wide range of applications - including Energy Generation & Distribution, Transportation, Heavy Equipment, Factory Automation, Wireless Outdoor, Information Technology and Data Communications Equipment, Mobile Devices, Mobile Networks, Broadband Communication, Military and Commercial Aerospace, Industrial, Automotive and Chip Card Readers - enabling smarter, faster and better technologies to connect products to customer solutions.

Our engineers design innovative combinations of industry standard connectors and application specific shielding components to create assembly systems that set the standards for performance, reliability, and cost effectiveness. Our engineering, materials, and manufacturing organizations meet the high standards imposed by ISO 9001:2008 as well as many customer specific quality systems. Our performance has earned us ship to stock and world class performance awards from many major OEMs.

We are one of the largest interconnect solution suppliers in the world and supply a wide range of product solutions globally. The industrial market footprint of Amphenol covers more than 30 countries.



Standard products. Custom solutions.

Our Factory Automation - Distributed Power and Control product lines, which include PowerBOSSlite™ M22 and M35, PowerBOSS™ M40 and M40 featuring Checkmate™ Technology, PowerBOSS™, ControlBOSS™, miniBOSS™ M22, microBOSS™ M12, DeviceNet, ControlPower, Ethernet and our VersaBOSS™ Series, have key placement in most areas of Automation. Based on our proven build-quality, high-performance capabilities and comparable mating to other existing standard products industry-wide, our Factory Automation products are reliable alternatives for you.

We can custom design, engineer and manufacture cable assemblies to your exact customer specifications and produce large or small quantities, all to the highest standards, delivered on-time and in-specification, all with a significant cost-savings over the competition.

By combining locally-based Program Management & Engineering, along with the associated cost advantages derived from manufacturing in our low-cost production centers in North America and Asia, our Team will work with you to design the most cost-efficient and reliable interconnect system available.



Product Overviews

The products in this catalog were developed in response to the need for a robust, streamlined and scalable product for use in most robotic and material handling systems, such as: conveyors, sorting, automated storage and retrieval, packaging, overhead transport, palletizing and any other options imaginable. If you have a custom project and are in need of more specialized connectors or cable assemblies, please contact us directly at +1 800 394 7732 and we will direct you to the appropriate Program Manager for your needs.



PowerBOSSlite™ M35 (1 3/8") Pg. 14 3 & 4 positions available

- 30A Max Current; 600V; 10AWG
- High-performance, cost-effective
- Single and Dual-rated cable options
- Comparable with existing standard products industry-wide
- Select parts available in Black and Red options



PowerBOSSlite™ M22 (7/8") Pg. 26 3 & 4 positions available

- 15A Max Current; 600V; 14AWG
- High-performance, cost-effective
- Single and Dual-rated cable options
- Comparable with existing standard products industry-wide
- Select parts available in Black and Red options



PowerBOSS™ M40 featuring **CheckMate™** Pg. 32 6 position

Features Checkmate™ Advanced Interconnect System

- Color-coded, 1/4-turn locking mechanism
- Safety Sleeve and Clip Assembly

- *8AWG: 32A (Power), 5A (Signal) Max Current; 600V
- 10AWG: 25A (Power), 5A (Signal) Max Current; 600V
- High-performance, cost-effective



*The Industrial@Amphenol products found within this section are UL 2237 Listed for the amperage ratings provided. However, for higher amperage requirements with governances outside of this specific UL listing, please consult your salesperson as higher amperage values may be applicable.

Product Overviews, cont.



PowerBOSS™ M40 Pg. 42

6 position

- *32A (Power) 5A (Signal) Max Current; 600V
- High-performance, cost-effective
- Comparable with existing standard products industry-wide



*The Industrial@Amphenol products found within this section are UL 2237 Listed for the amperage ratings provided. However, for higher amperage requirements with governances outside of this specific UL listing, please consult your salesperson as higher amperage values may be applicable.



PowerBOSS™ Pg. 46

9 position

- 40A Max Current; 600V; 8-12AWG
- 4+PE (Power), 4 (Signal)
- Contains a single channel safety relay to de-energize the cable to prevent arch flash upon disconnection



ControlBOSS™ Pg. 58

9 position

- 14-18AWG
- 6+PE (Power), 3 (Signal)
- 15A (Power), 2A (Signal)
- Combination of DeviceNet + 2 Add'l Circuits



ControlPower Pg. 84

6 position/5 Used

- 10A Max Current; 600V; 16AWG
- High-performance, cost-effective
- Comparable with existing standard products industry-wide
- Select parts available in Black and Red options



Product Overviews, cont.



VersaBOSS™ FC Hybrid Pg. 72

9 position

- 20A (Power), 5A (Signal) Max Current; 16-18AWG
- 600V (Power), 30V (Signal) Max Voltage, 16-18AWG
- High-performance, cost-effective
- Available in High-Flex/TPE Yellow and Static/PVC Black Cable
- Blue overmold



VersaBOSS™ MC Pg. 76

9 position

- 20A (Power), 5A (Signal) Max Current; 13-18AWG
- 600V (Power), 30V (Signal) Max Voltage; 13-18AWG
- High-performance, cost-effective
- Available in High-Flex/TPE Yellow and Static/PVC Black Cable
- Black overmold



VersaBOSS™ Powerflex Pg. 80

9 position

- 20A (Power), 5A (Signal) Max Current; 12-18AWG
- 600V (Power), 30V (Signal) Max Voltage; 12-18AWG
- High-performance, cost-effective
- Available in High-Flex/TPE Yellow and Static/PVC Black Cable
- Yellow overmold



miniBOSS™ M22 (7/8") Pg. 88

2, 3, 4, 5 and 6 positions available

- 13A Max Current; 600V Max Voltage; 16AWG
- Utilizes UL ST00W/CSA Type ST cable
- High Flex TPE jacketed UL Listed TC-ER cable option
- High-performance, cost-effective
- Comparable with existing standard products industry-wide



Product Overviews, cont.



microBOSS™ M12 (1/2") Pg. 92

3, 4 and 5 positions available

- 4A Max Current; 300V Max Voltage; 22AWG
- Utilizes both UL AWM-style 2661 and CSA/AWM I/II A/B cable
- Flex and High Flex cable options
- High-performance, cost-effective
- Comparable with existing standard products industry-wide



DeviceNet Pg. 96

5 position available

- Max Current, per Cable; 300V; 15-24AWG
- Available in Static, Thick and Thin cable
- Utilizes UL Type CL2 or PLTC and CSA AWM I/II A/B FT4 cable
- Flex and High Flex cable options
- High-performance, cost-effective
- Comparable with existing standard products industry-wide



Ethernet Pg. 102

4 pos. (Plug/Receptacle) and 8 pos. (RJ45) available

- Cat 5e Cable
- 24AWG/2 Pair
- M12 and RJ45 Combinations
- TPE Jacketing/High Flex Options
- High-performance, cost-effective
- Comparable with existing standard products industry-wide



Why & Where?

Why Amphenol Modular Pre-Wired Connection Systems for Industrial Power Distribution & Motor Control?

Today's rapidly evolving industrial wiring protocols in conjunction with the demands of cable shielding requirements have dictated the rapid acceleration of "Quick-Connect" topologies within the past decade. Increasingly, designers & integrators of automation and control systems are specifying within their architectures the performance and reliability derived from code-compliant, high quality, factory-molded Amphenol cabling systems.

These streamlined modern connectivity systems accommodate many diverse performance requirements for industrial machinery end users and the electrical contractors which serve them. Previous methodologies which utilized hard-wired or conduit are inherently costly to implement, inflexible, and wrought with complications derived from the inconsistencies of field terminations. Factor in the deployment of field technicians, subsequent debugging, and the accumulative effect of these delays preventing timely commissioning of equipment, in addition to the costs associated with licensed electricians to install them and your bottom line just got a lot thinner.

Amphenol's proven wiring systems offer time savings during both the plant layout and installation phases by simplifying your wiring needs. Engineered for fast, flexible on-site connections without specialized tools, complex cable schematics and a reduced reliance on highly skilled labor allows your system commissioning time to run on budget. Even when your plant-floor requirements change, these modular and scalable systems allow you to rapidly reconfigure to meet your customers' changing demands.

Greater Flexibility Equals Lower Total Cost of Ownership

- **Rapid Install Due to Scalable Modular Design at Startup**
- **Repeatable System for Expansion or Plant Reconfiguration**
- **Faster Commissioning with Reliable "Plug & Play" Capability Dramatically Reduces Costs**
- **Factory Assembled & Code Compliant System Eliminate Field Wiring Errors & Cable Pullout**
- **Eliminates Traditional Raceways, Conduit & Cable Glands while Increasing Ingress Protection**
- **Quick Disconnects Minimize Downtime from Removal or Replacement of Failed Equipment**
- **Rugged Over-molded Connectors & Feature Crush & Oil Resistant Cables**
- **Cable Topology is designed before Plant Delivery by the Machine Design Engineer**

Proven Quality

Amphenol prides itself on its consistent quality products. Our designs have been tested in the lab and verified around the world. Each assembly is tested electrically to ensure your systems reliability. Our modular connection architectures feature available options such as crush resistant, pre-wired cord sets with rugged factory molded connectors. Compliant with various code compliances such as NFPA 79-2007 standards. UL2237 PVVA Listed.

Why & Where?

Custom Capabilities

To meet a wide variety of application specifications, Amphenol offers the advantage of cordsets with built-to-order, custom capabilities. We offer a complete turnkey solution to meet your application demands. Highly configurable and repeatable wiring topologies can be customized to achieve plant flexibility. These cordsets can be manufactured to customer specifications to include custom mold colors, wiring and environmental protection. Our products provide customers optimum scalability and flexibility while simplifying your electrical requirements with a practical solution that can be tailored to fit individual application specifications, yet still be cost efficient.

Flexible Power & Control Where YOU Need it.

- Automated Machine Tools
- Overhead Transport
- Distributed Power & Control of Motors
- Palletizing, Packing and Shrink Wrapping
- Automated Assembly
- Airport Baggage Handling
- Material Handling
- Automotive Processing
- Packaging Equipment
- Food and Beverage Processing
- Logistics
- Pharmaceutical Process Equipment
- Automated Storage and Retrieval
- Petrochemical Plants
- Parcel Distribution
- Communication Devices



Installation Considerations

1. Determine the amperage/voltage requirements for your specific application.
2. NEVER disconnect cordset while it is under load
3. Always supply power from the Female connector
4. Protect connectors from damage with closure caps

Note: Reference NFPA 79 (Electrical Standards for Industrial Machinery) for required over current protection of conductors and installation guidelines pertaining to industrial machine applications.

For Temporary Installs: Cordsets with STOOW ratings allow for installations under the NEC article 400, 'Flexible Cords and Cables'. STOOW cables are more resilient and can be used to connect temporary equipment, such as fans, lights, etc. And can be utilized on flooring where harsher conditions exist, especially when compared to TC only rated cable. STOOW is an Underwriters Laboratories classification meaning the system includes hard-service flexible cord with thermoplastic insulation, in which both the jacket and the conductor insulation are oil-resistant, and the assembly is also moisture and sunlight resistant.

For Permanent (or Temporary) Installs: Multiple ratings allow cable assemblies to be used anywhere within the install. TC, ER and MTW ratings allow for usage inside trays/raceways, and STOOW and Open Wiring designated TC cables can be exposed along the structure while maintaining crush/impact resistance of an MC(metal clad) cable.

Cables which achieve a TC-ER have passed stringent crush and impact test, allowing them to be used in "Exposed Runs" (ER) per the installation guidelines of NFPA 79 and/or NEC 336.10(7). These cables do not require cable trays if they are mechanically protected with angles, struts or channels every 1.8m (6'). Are permitted between a cable tray and the utilization equipment or device...secured at intervals not exceeding 1.8m (6'). Permitted to transition between cable trays and utilization equipment or devices for a distance not exceeding 1.8m (6') without continuous support. In addition, these cables also pass UL 1569 effectively eliminating the need for expensive metal requirements which would otherwise be required.

When determining your system requirements and layout, ensure only code compliant practices and wiring methods are deployed. To provide your flexible-wiring implementation with an enhanced level of safety you require, either STOOW/ TC ER or the TC ER only products are regarded as premium cable protection options. However, you may select a TC-ER only cable option versus the dual rated STOOW/ TC-ER from many of the Amphenol PowerBoss products. As a result, these options will provide slightly reduced cable diameters, yielding increased flexibility in addition to an improved cost point.

Installation Considerations

Theoretical Horsepower Ratings

Note: These tables are for reference only, and are based on 85% motor efficiency and 90% power factor. Please consult the drive/motor manufacturer for specific FLC ratings and temperature deratings. Reference NFPA 79 2007 edition.

| Pins | Wire Gauge (AWG) / Amperage (A) | Voltage (V) | Horsepower (hp) |
|-------------------------------------|---------------------------------|-------------|-----------------|
| 3 (Single Phase 2 Conductors) | 10AWG / 30A | 230V | 7hp |
| | | 460V | 14hp |
| | | 575V | 17hp |
| | 12AWG / 25A | 230V | 5hp |
| | | 460V | 11hp |
| | | 575V | 14hp |
| | 14AWG / 18A | 230V | 4hp |
| | | 460V | 8hp |
| | | 575V | 10hp |
| Pins | Wire Gauge (AWG) / Amperage (A) | Voltage (V) | Horsepower (hp) |
| 4 (Three Phase 3 Conductors) | 10AWG / 25A | 230V | 10hp |
| | | 460V | 20hp |
| | | 575V | 25hp |
| | 12AWG / 20A | 230V | 8hp |
| | | 460V | 16hp |
| | | 575V | 20hp |
| | 14AWG / 15A | 230V | 6hp |
| | | 460V | 12hp |
| | | 575V | 15hp |

Amphenol's wiring systems can achieve up to 40A, 600V for 8AWG trunk connector. This amperage (A) rating should be applied according to the rules set forth in NEC article 430 for sizing circuits for motor control applications.

Reference for NFPA 79, UL, cUL, TC and TC-ER

NFPA 79 - 2007 Compliant

NFPA 79 applies to the electrical equipment used within a wide variety of machines, as well as, groups of machines working together in a coordinated manner. Examples of industrial machinery include, among others: machine tools, injection molding machines, woodworking equipment, assembling machinery, material handling machinery and inspection and testing machines. The scope of NFPA 79 includes all electrical and electronic elements of the machinery operating at 600V or less.

In 2007, the NFPA 79 code underwent significant revisions. The main goal of the revision was to harmonize NFPA 79 with its European counterpart, IEC-60204. This involved reorganizing the NFPA 79 chapter structure to follow IEC-60204 while adopting less restrictive, more progressive requirements without sacrificing the equipment safety.

Conductor Sizing for Power Circuits

1997 Ed.: Section 15.3(a): Conductors shall be no smaller than 14AWG

2007 Ed.: Section 12.6.1: Conductors shall not be smaller than 14AWG for power circuits unless otherwise permitted in 12.6.1.1 (16 AWG) and 12.6.1.2 (18 AWG).

Wiring Methods and Practices Regarding Connectors

1997 Ed.: Section: 16.1.4: Conductors and cables shall be run without splices from terminal to terminal.

2007 Ed.: Section 13.1.2.2: Factory-applied connectors, molded onto cables, shall be permitted. Such connectors shall not be considered as splices or joints.

Wiring Methods and Practices Regarding Exposed Cable

1997 Ed.: Section 16.3.1: Conductors and their connections, external to the control panel, shall be totally enclosed in suitable raceways or enclosures.

2007 Ed.: Section 13.1.5.1: Exposed cables, installed along the structure of the equipment or system or in the chases of the machinery, shall be permitted. Exposed cables shall be installed to closely follow the surface and structural members of the machinery

UL 2237 (PVVA) Listed - System integrity and Safety Preservation

Simply reset or eliminate the faulty condition and continue system operation. Perfect for applications with a high potential for extreme electrical transients.

UL/cUL - Underwriters Laboratory, Inc.

UL is the leading organization for electrical safety in the USA. Products approved by UL are marked with a corresponding logo. Products that are labeled 'UL Listed' means that UL has tested and evaluated representative samples of the product to determine they meet UL standards. This type of UL mark is commonly seen on appliances, computer equipment, furnaces, heaters, fuses, electrical panel boards, smoke and carbon monoxide detectors, fire extinguishers, personal flotation devices, bullet resistant glass, and other products. The cUL mark is applied to products intended for the Canadian market. They have been evaluated to Canadian safety requirements, which may differ from U.S. safety standards.

Architectural Layouts - Traditional

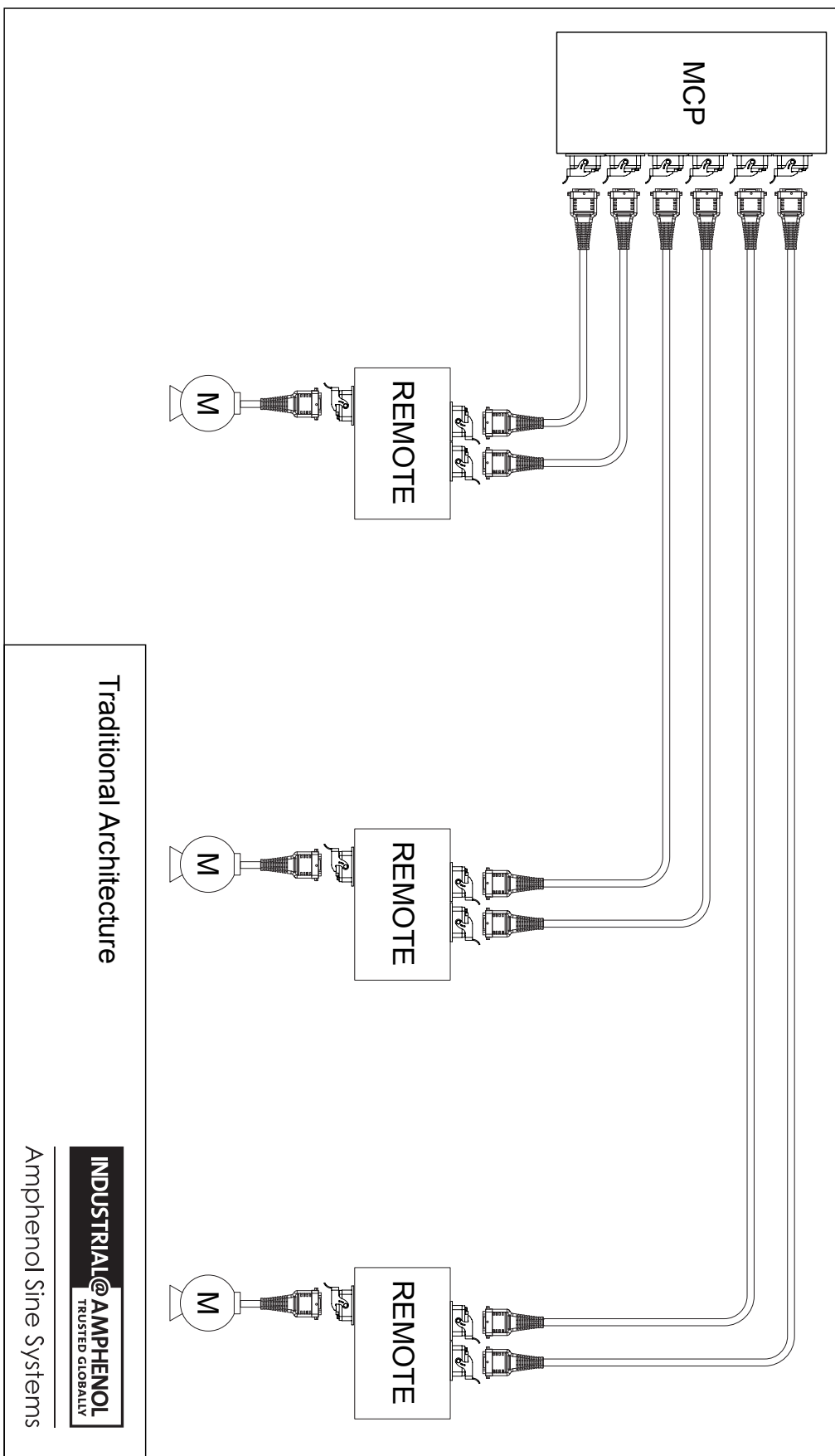

Architectural Layouts - Power and Control

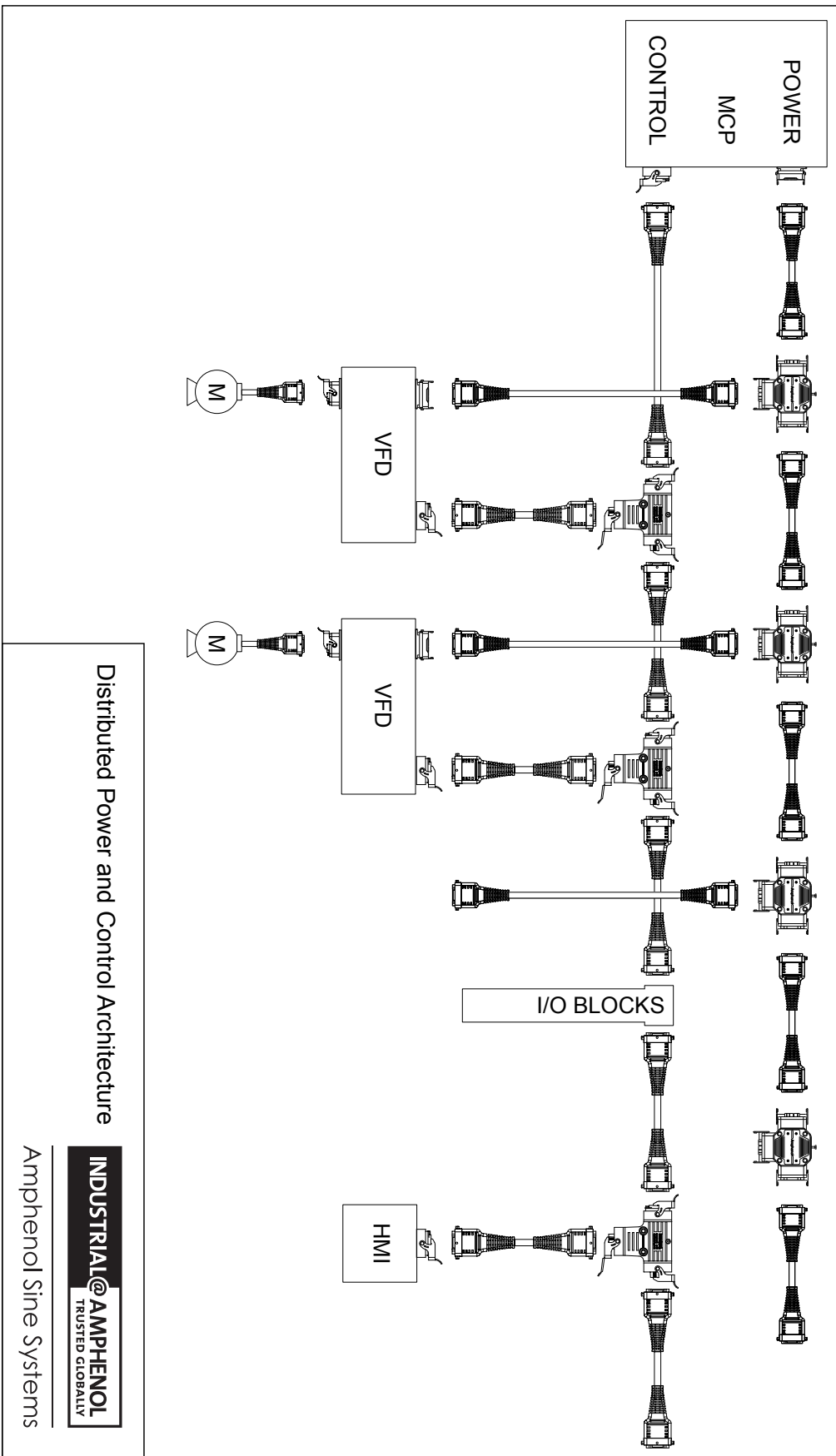

This page intentionally left blank.

PowerBOSSlite™ M35

Power Distribution System



- Easy 'Plug & Play' Installation • Scalable • Easy to Repeat
- Faster Install & Labor Times • Faster to Market Time • Less Downtime
- Increased Worker Productivity • Elimination of Specialized Tooling
- Reduced Maintenance, Manufacturing and Labor Costs

(This layout includes our VersaBOSS™ product line. Please reference pages 68-84 for product specifics.)

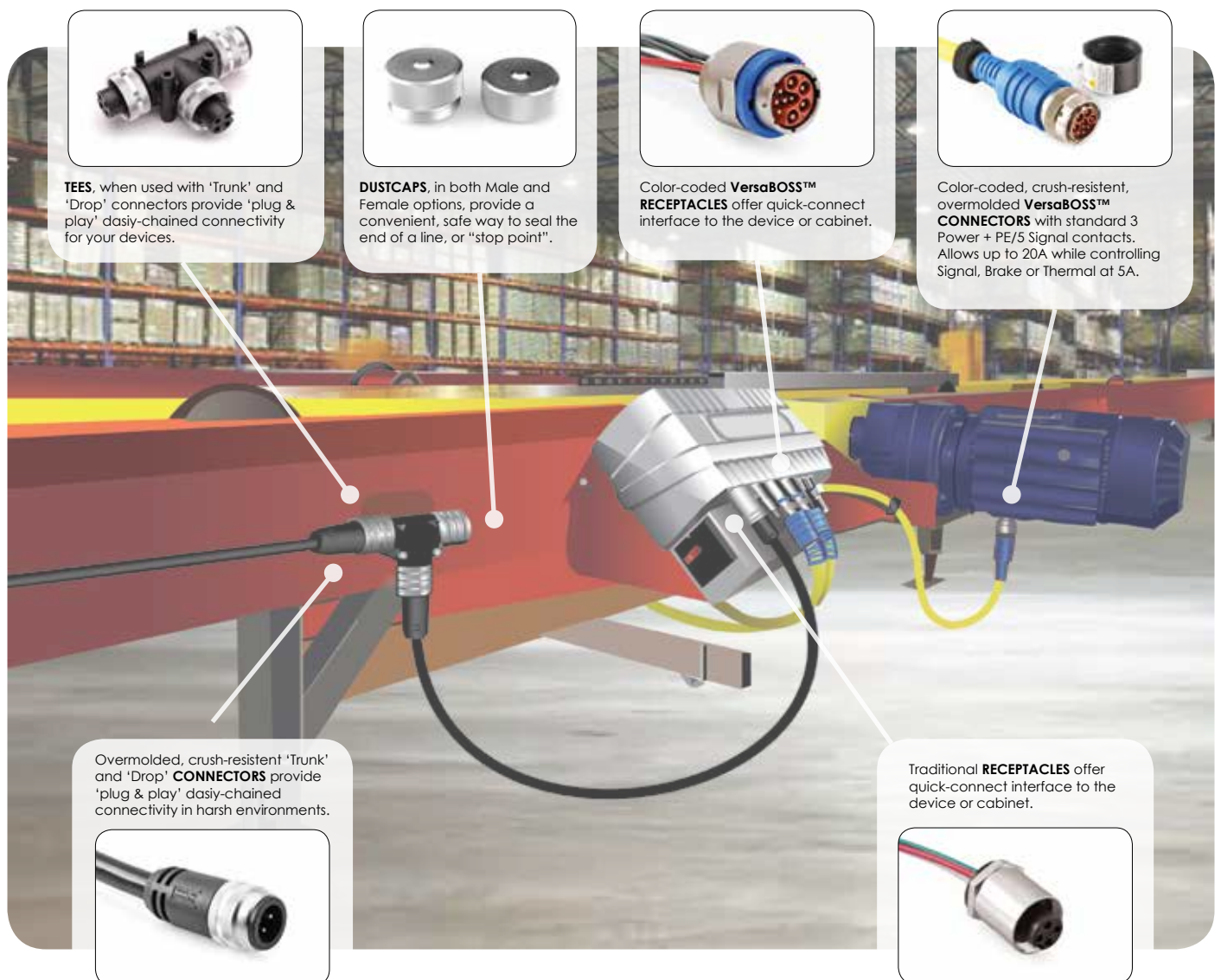

TEES, when used with 'Trunk' and 'Drop' connectors provide 'plug & play' daisy-chained connectivity for your devices.

DUSTCAPS, in both Male and Female options, provide a convenient, safe way to seal the end of a line, or "stop point".

Color-coded **VersaBOSS™ RECEPTACLES** offer quick-connect interface to the device or cabinet.

Color-coded, crush-resistant, overmolded **VersaBOSS™ CONNECTORS** with standard 3 Power + PE/5 Signal contacts. Allows up to 20A while controlling Signal, Brake or Thermal at 5A.

Overmolded, crush-resistant 'Trunk' and 'Drop' **CONNECTORS** provide 'plug & play' daisy-chained connectivity in harsh environments.

Traditional **RECEPTACLES** offer quick-connect interface to the device or cabinet.

Custom Solutions

We offer custom solutions to meet your specific needs. Contact one of our Sales Representatives at +1 800 394 7732.

















M35 (1 3/8") - 3 & 4 Position Specifications

| | | | |
|-------------------|--|----------------------|-------------------------------------|
| Temperature Range | -20°C to +90°C Single-rated; -20°C to +105°C Dual-rated | Contact Plating | 5µ"(min) Gold over 25µ"(min) Nickel |
| Body | Oil resistant PVC | Connector Face | PVC |
| Contacts | Gold-plating over Copper Alloy | Coupler Housing | Machined Aluminum, Anodized |
| Protection | IP67, NEMA 6P | Receptacle Housing | Machined Aluminum, Anodized |
| NFPA-79 | Meets standards for motor/branch circuits | Short Circuit Rating | 65kA |

| Single and Dual Rating Specifications | | | | |
|---------------------------------------|---|--|--|------------------------|
| Cable Trunk - Single-rated | PVC insulated #10AWG stranded copper (105 x 30) | TC-ER Only UL Listed; FT-4 Flame Rating | 600V, 90°C Dry/Wet | Black TPE Cable Jacket |
| Cable Trunk - Dual-rated | PVC insulated #10AWG stranded copper (105 x 30) | TC-ER/STOOW: UL listed; FT2; CSA certified type STOOW | 600V, 90°C Dry/75°C Wet (TC-ER), 105°C (STOOW) | Black PVC Cable Jacket |





















M35 (1 3/8") - 3 & 4 Position Trunk Cable Assemblies

Mxxx = length in meters

| | 3 Pos. (Trunk); 600V; 30A; 10AWG | | 4 Pos. (Trunk); 600V; 25A; 10AWG |
|---|--|---|--|
| Cable Diameter | 0.48" (12.2mm) Single-rated; 0.67" (17.0mm) Dual-rated | | 0.56" (14.2mm) Single-rated; 0.72" (18.3mm) Dual-rated |
| Color Code | 1-Black, 2-Green, 3-White | | 1-Black, 2-Grn/Yel, 3-Red, 4-White |
| Overmold Colors | Black | Red | Black |
| Male Straight, Single-rated TC-ER (See FIG 1, Pg 20) |  P30768-Mxxx |  P30882-Mxxx |  P30752-Mxxx |
| Male 90, Single-rated TC-ER (See FIG 3, Pg 20) |  P30769-Mxxx |  P30885-Mxxx |  P30753-Mxxx |
| Female Straight, Single-rated TC-ER (See FIG 2, Pg 20) |  P30770-Mxxx |  P30883-Mxxx |  P30754-Mxxx |
| Female 90, Single-rated TC-ER (See FIG 4, Pg 20) |  P30771-Mxxx |  P30886-Mxxx |  P30755-Mxxx |
| Male Straight, Dual-rated TC-ER/STOOW (See FIG 1, Pg 20) |  P29000-Mxxx | - |  P28992-Mxxx |
| Male 90, Dual-rated TC-ER/STOOW (See FIG 3, Pg 20) |  P29001-Mxxx | - |  P28993-Mxxx |





M35 (1 3/8") - 3 & 4 Position Trunk Cable Assemblies, cont.

Mxxx = length in meters

| | 3 Pos. (Trunk); 600V; 30A; 10AWG | | 4 Pos. (Trunk); 600V; 25A; 10AWG |
|---|--|---|--|
| Cable Diameter | 0.48" (12.2mm) Single-rated; 0.67" (17.0mm) Dual-rated | | 0.56" (14.2mm) Single-rated; 0.72" (18.3mm) Dual-rated |
| Color Code | 1-Black, 2-Green, 3-White | | 1-Black, 2-Grn/Yel, 3-Red, 4-White |
| Overmold Colors | Black | Red | Black |
| Female Straight, Dual-rated TC-ER/STOOW (See FIG 2, Pg 20) |  P29004-Mxxx | - |  P28996-Mxxx |
| Female 90, Dual-rated TC-ER/STOOW (See FIG 4, Pg 20) |  P29005-Mxxx | - |  P28997-Mxxx |
| Male Str/ Female Straight, Single-rated TC-ERH (See FIG 1 and 2, Pg 20) |  P30764-Mxxx |  P30881-Mxxx |  P30748-Mxxx |
| Male Str/ Female 90, Single-rated TC-ER (See FIG 1 and 4, Pg 20) |  P30765-Mxxx |  P30887-Mxxx |  P30749-Mxxx |
| Male 90/ Female Straight, Single-rated TC-ER (See FIG 2 and 3, Pg 20) |  P30766-Mxxx |  P30888-Mxxx |  P30750-Mxxx |
| Male 90/ Female 90, Single-rated TC-ER (See FIG 3 and 4, Pg 20) |  P30767-Mxxx |  P30884-Mxxx |  P30751-Mxxx |
| Male Straight/ Female Straight, Dual-rated TC-ER/STOOW (See FIG 1 and 2, Pg 20) |  P28984-Mxxx |  P30253-Mxxx |  P28976-Mxxx |
| Male Straight/ Female 90, Dual-rated TC-ER/STOOW (See FIG 1 and 4, Pg 20) |  P28985-Mxxx | - |  P28977-Mxxx |











M35 (1 3/8") - 3 & 4 Position Trunk Cable Assemblies, cont.

Mxxx = length in meters













| | 3 Pos. (Trunk); 600V; 30A; 10AWG | | 4 Pos. (Trunk); 600V; 25A; 10AWG | |
|---|--|--|--|--|
| Male 90/ Female Straight, Dual-rated TC-ER/STOOW (See FIG 2 and 3, Pg 20) |  P28986-Mxxx | |  P28978-Mxxx | |
| Male 90/ Female 90, Dual-rated TC-ER/STOOW (See FIG 3 and 4, Pg 20) |  P28987-Mxxx | |  P28979-Mxxx | |
| Male 90/Female Straight, Single-rated, TC-ER, SHIELDED (See FIG 2 and 3, Pg 20) | | |  P29359-Mxxx | |

M35 (1 3/8") - 3 & 4 Position Trunk Receptacles









Mxxx = length in meters

| | 3 Pos. (Trunk); 600V/30A; 10AWG | | 4 Pos. (Trunk); 600V/25A; 10AWG | |
|--|--|--|---|--|
| Color Code | 1-Black, 2-Green, 3-White | | 1-Black, 2-Grn/Yel, 3-Red, 4-White | |
| Thread Type | 1/2-14NPT | 3/4-14NPT | 1/2-14NPT | 3/4-14NPT |
| Male, Standard Wire Color External Threads (See FIG 5 and 7, Pg 20) |  P29030-Mxxx |  P29028-Mxxx |  P29059-Mxxx |  P29057-Mxxx |
| Female, Standard Wire Color Internal Threads (See FIG 6 and 8, Pg 20) |  P29034-Mxxx |  P29032-Mxxx |  P29026-Mxxx |  P29024-Mxxx |
| Female, Specialty Wire Color (BLK, GR/YEL, BLK, BLK) Internal Threads (See FIG 6 and 8, Pg 20) | | |  P29360-Mxxx |  P29361-Mxxx |

M35 (1 3/8") - 3 & 4 Position Tees

| | 3 Pos.; 600V; 30A (Trunk), 30A (Drop) | | 4 Pos.; 600V; 25A (Trunk), 25A (Drop) | |
|---|---|---|--|---|
| Overmold Colors | Black | Red | Black | Red |
| Standard (See FIG 9 Pg 21 and FIG 14 Pg 22) |  P28966 |  P29855 |  P28964 |  P30869 |
| "h" Tee (See FIG 11 Pg 21 and FIG 16 Pg 23) |  P30862 |  P30716 |  P30866 |  P30864 |
| WYE Tee (See FIG 13 Pg 22 and FIG 18 Pg 24) |  P31000 |  P31001 |  P29364 |  P31002 |

M35 (1 3/8") - 3 & 4 Position Tees, cont

| | 3 Pos.; 600V; 30A (Trunk), 30A (Drop) | | 4 Pos.; 600V; 25A (Trunk), 30A (Drop) | |
|--|---|---|--|---|
| Overmold Colors | Black | Red | Black | Red |
| Reducing Drop M35 (1 3/8") to M22 (7/8") (See FIG 10 Pg 21 and FIG 15 Pg 23) |  P28970 |  P30868 |  P28968 |  P30870 |
| "h" Tee, Reducing Drop M35 (1 3/8") to M22 (7/8") (See FIG 12 Pg 22 and FIG 17 Pg 23) |  P30863 |  P30717 |  P30867 |  P30865 |

M35 (1 3/8") to M22 (7/8") - 3 & 4 Position In-Line Reducers

| | 3 Pos.; 600V; 15A | | 4 Pos.; 600V; 15A | |
|--|--|--|---|--|
| Overmold Colors | Black | Red | Black | Red |
| Male M35 Trunk/ Female M22 Drop (See FIG 19 Pg 24 and FIG 20 Pg 24) |  P28974 |  P29858 |  P28972 |  P30871 |

M35 (1 3/8") & M22 (7/8") - Accessories

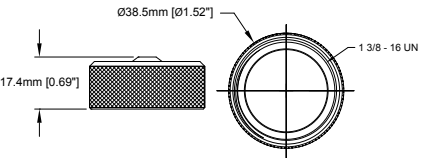
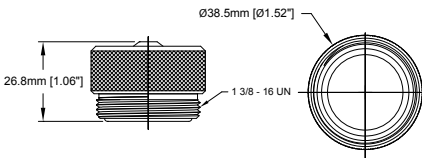
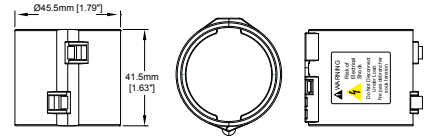
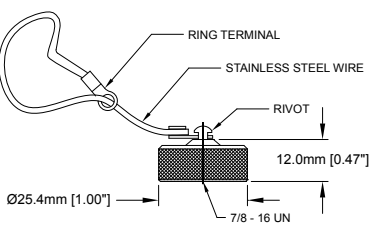
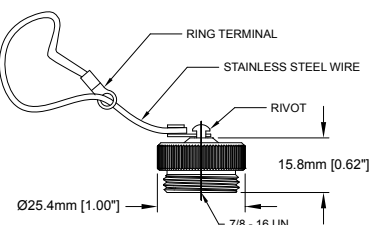
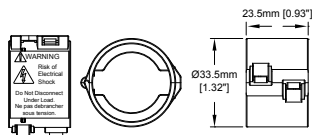
| | | |
|---|--|--|
| M35, Dustcap, Metal, Male Trunk w Internal Threads P29042 | M35, Dustcap, Metal, Female Trunk w External Threads P29043 | M35, Locking Clip, Trunk P29040 |
|  |  |  WARNING LABEL READS: Risk of Electrical Shock Do Not Disconnect Under Load. Ne pas debrancher sous tension. |
| M22, Dustcap, Metal, Male Drop w Internal Threads P29044 | M22, Dustcap, Metal, Female Drop w External Threads P29045 | M22, Locking Clip, Drop P29041 |
|  |  |  WARNING LABEL READS: Risk of Electrical Shock Do Not Disconnect Under Load. Ne pas debrancher sous tension. |

All Dimensions in: mm [inch]

Dimensional Drawings

FIG 1: Male, Plug, Straight, Trunk, 3 and 4 Position

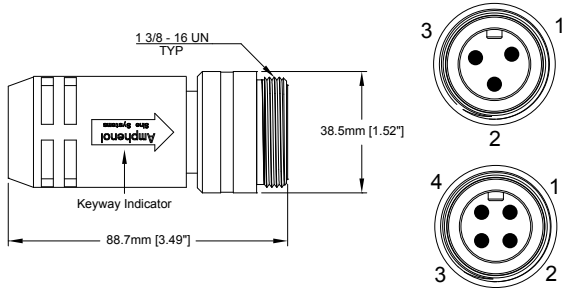

FIG 2: Female, Plug, Straight, Trunk, 3 and 4 Position

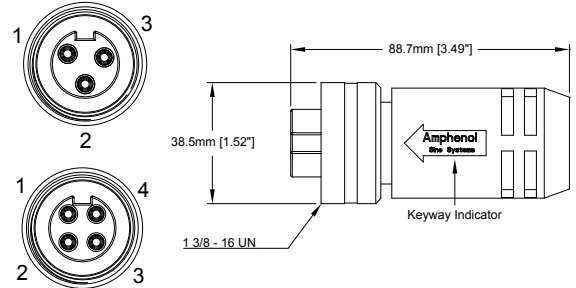

FIG 3: Male, Plug, 90°, Trunk, 3 and 4 Position

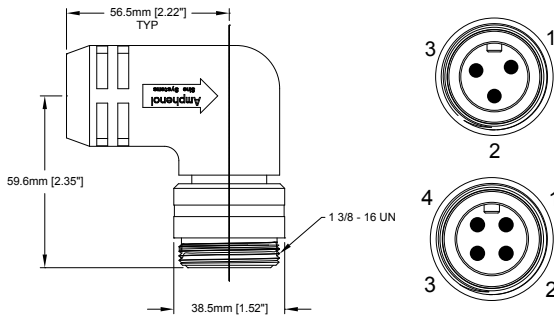

FIG 4: Female, Plug, 90°, Trunk, 3 and 4 Position

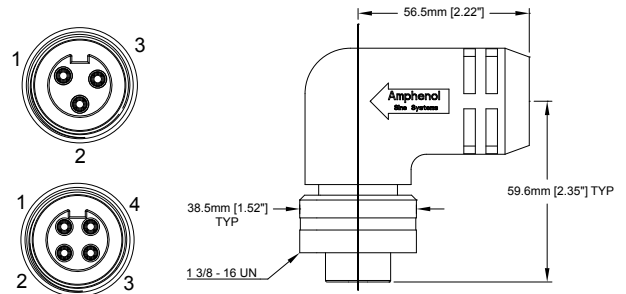

FIG 5: Male, 1/2-14NPT Receptacle, Trunk, 3 and 4 Position

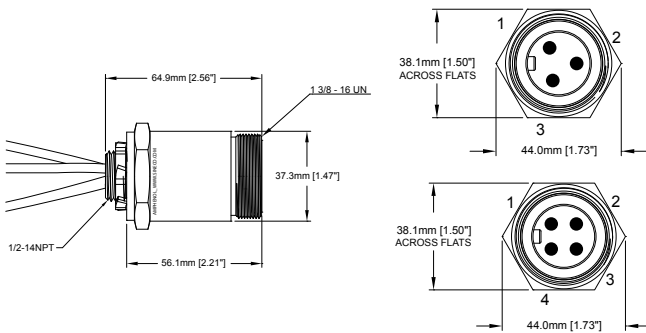

FIG 6: Female, 1/2-14NPT Receptacle, Trunk, 3 and 4 Position

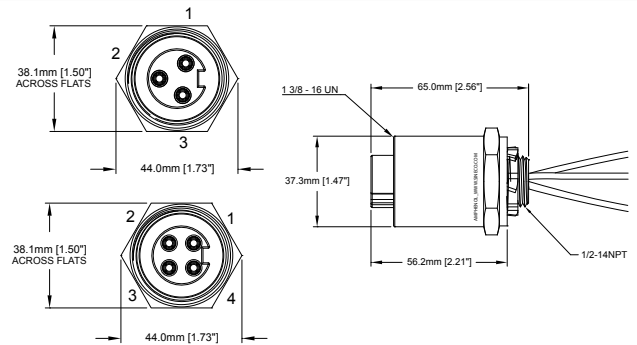

FIG 7: Male, 3/4-14NPT Receptacle, Trunk, 3 and 4 Position

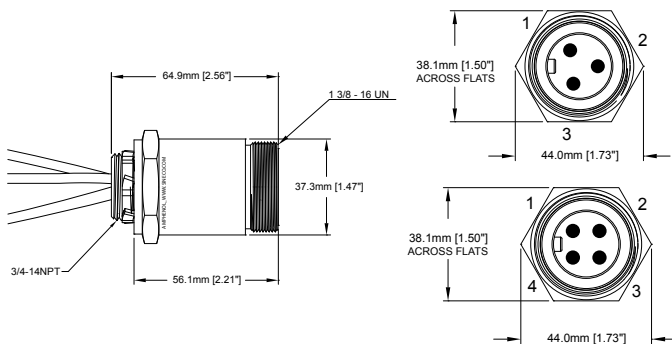
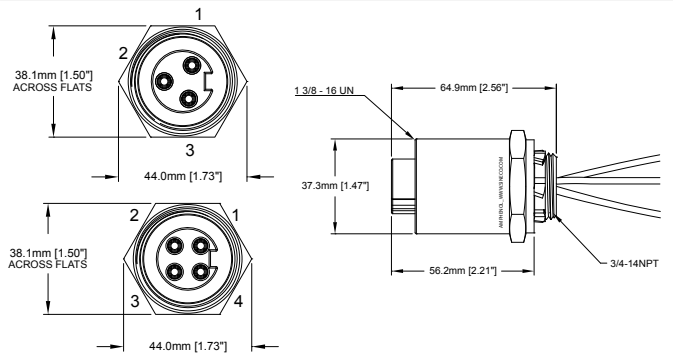

FIG 8: Female, 3/4-14NPT Receptacle, Trunk, 3 and 4 Position



All Dimensions in: mm [inch]

Dimensional Drawings, cont

FIG 9: Tee, 3 Position

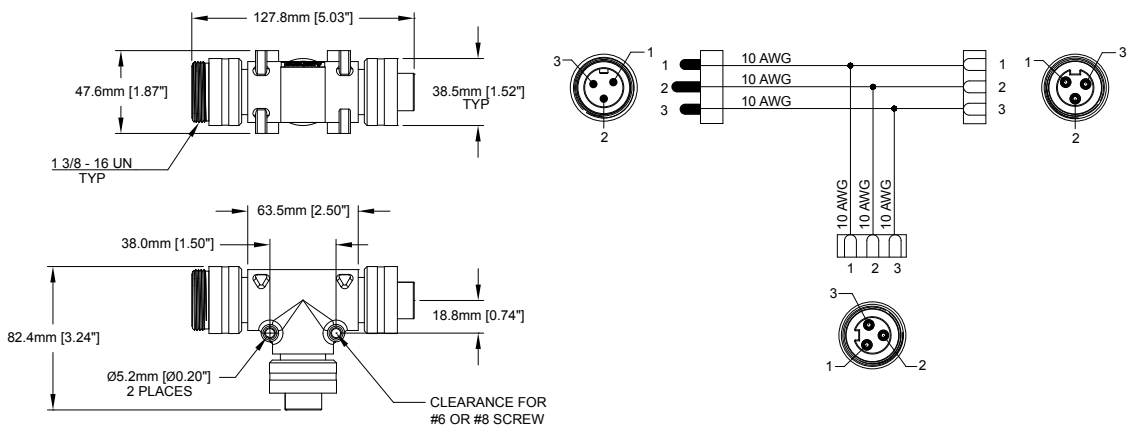

FIG 10: Reducing Tee, 3 Position

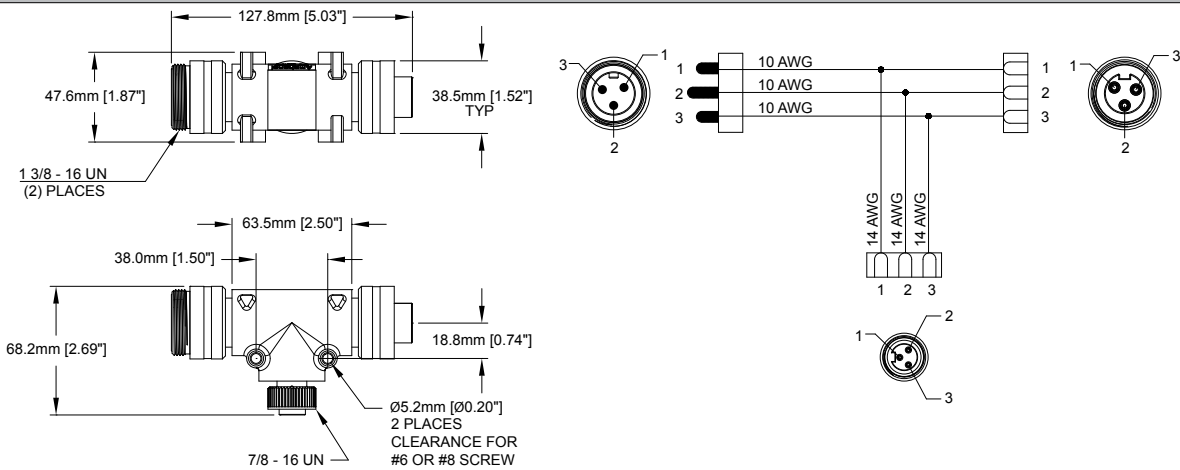
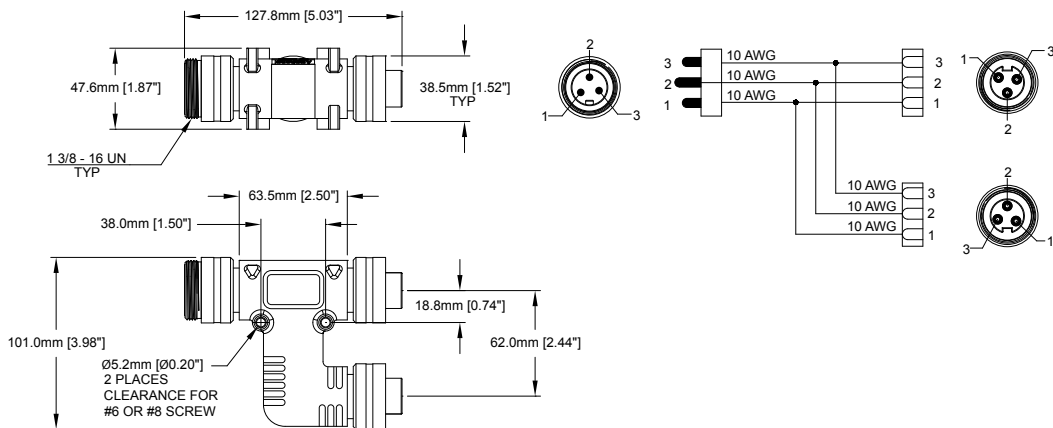

FIG 11: "h" Tee, 3 Position



All Dimensions in: mm [inch]

Dimensional Drawings, cont

FIG 12: "h" Reducing Tee, 3 Position

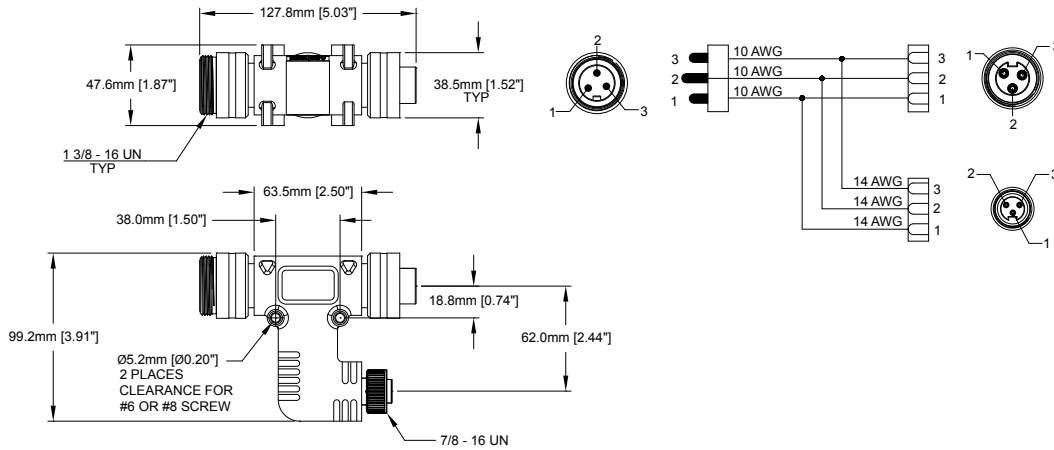

FIG 13: WYE Tee, 3 Position

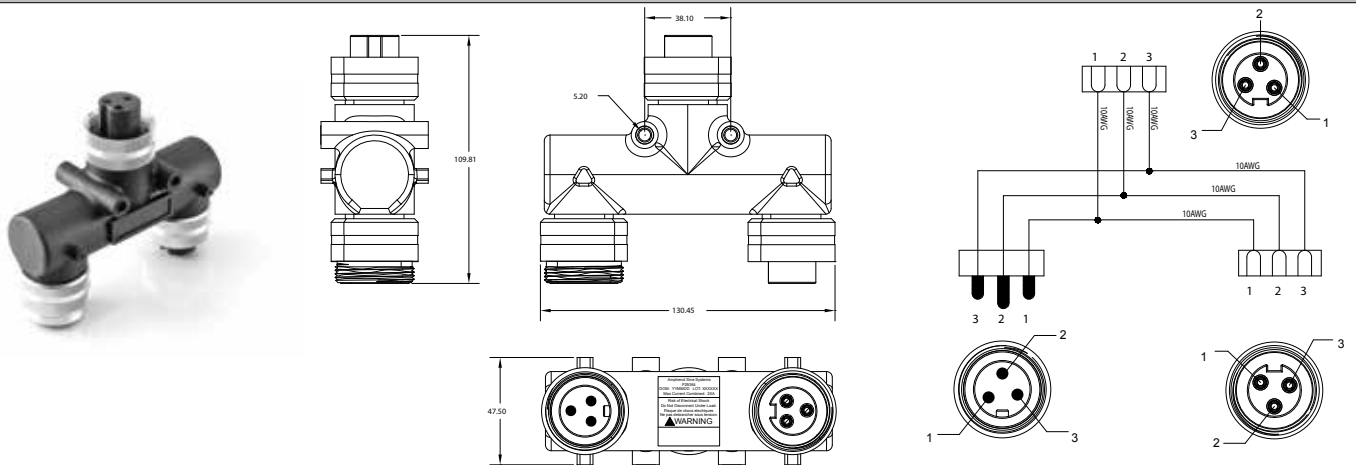
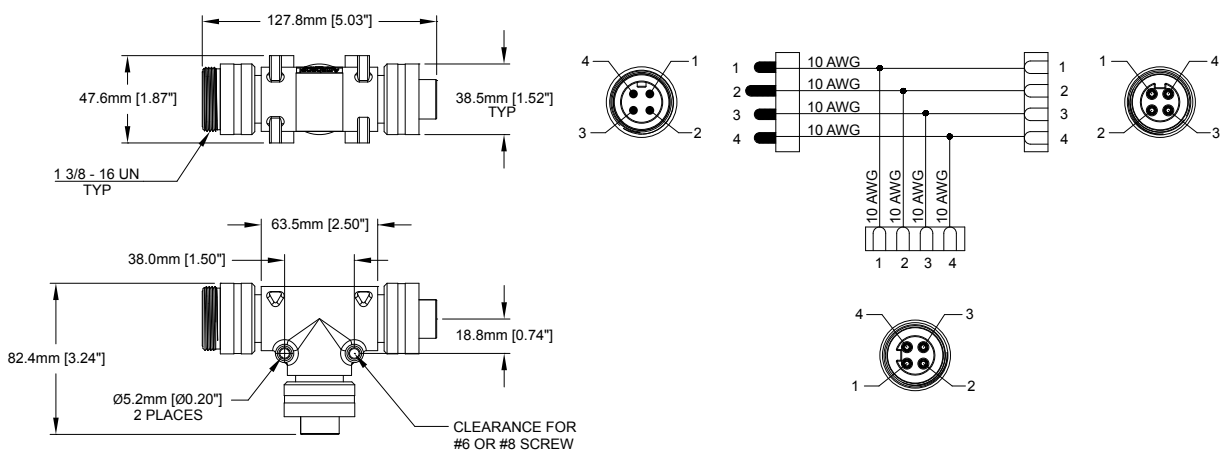

FIG 14: Tee, 4 Position



All Dimensions in: mm [inch]

Dimensional Drawings, cont

FIG 15: Reducing Tee, 4 Position

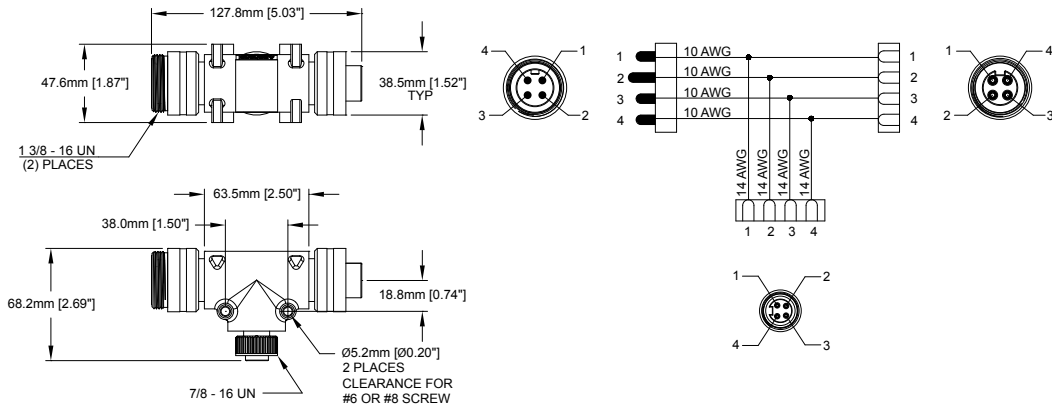

FIG 16: "h" Tee, 4 Position

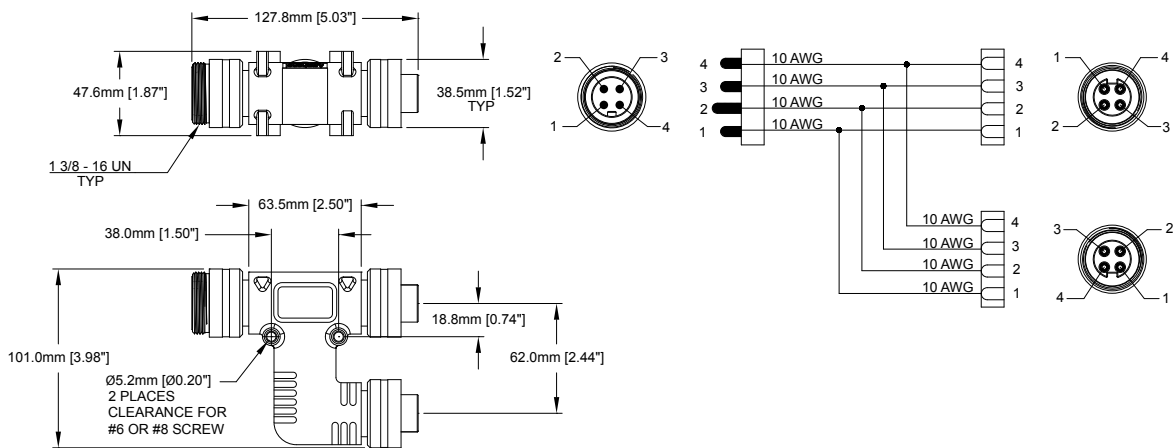
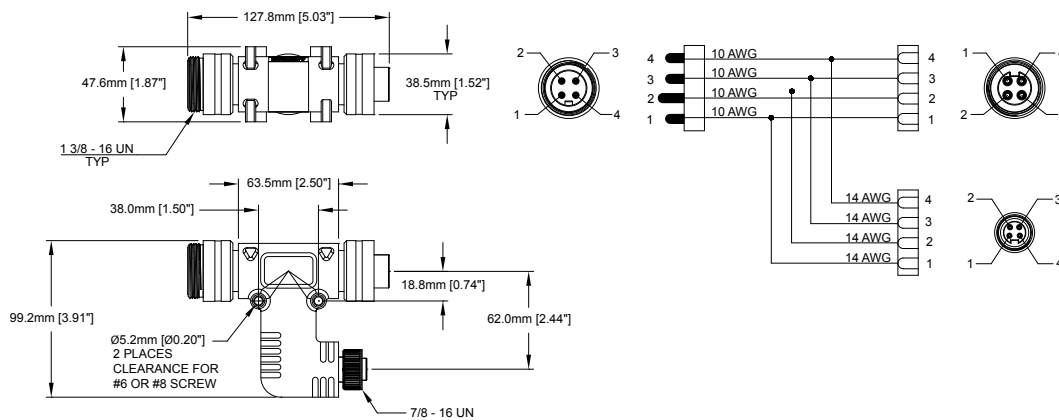

FIG 17: "h" Reducing Tee, 4 Position



All Dimensions in: mm [inch]

Dimensional Drawings, cont

FIG 18: WYE Tee, 4 Position

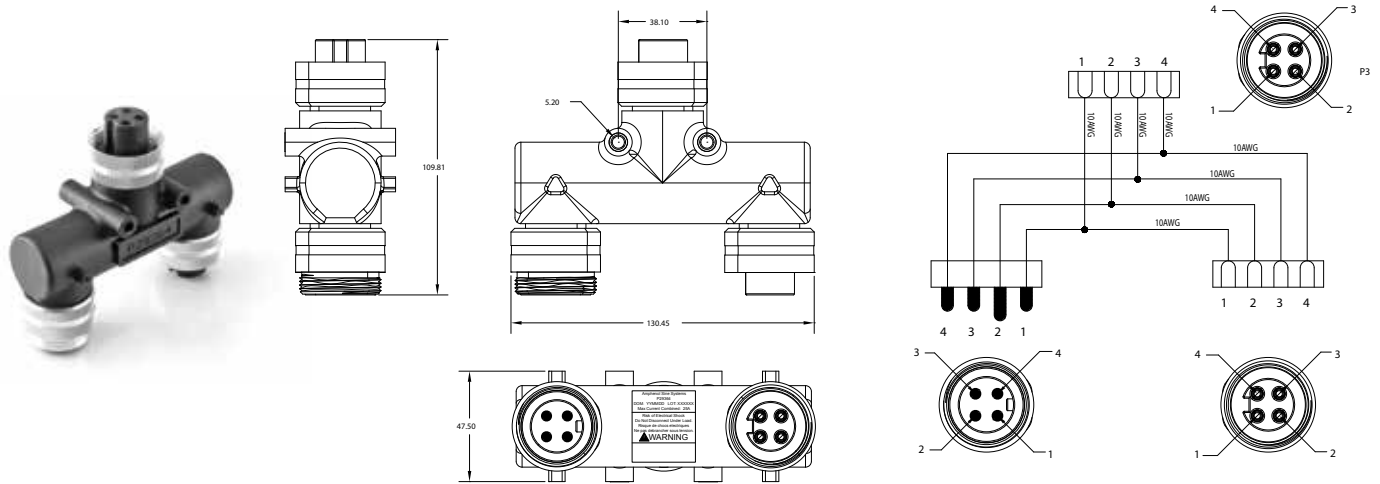

FIG 19: In-Line Reducers 3 Positions

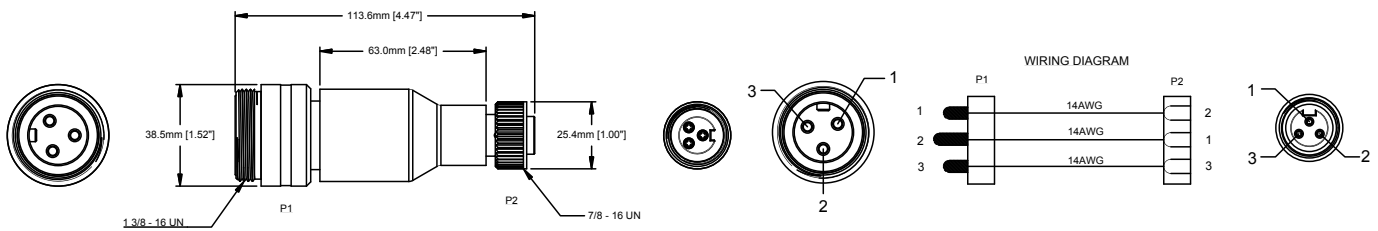
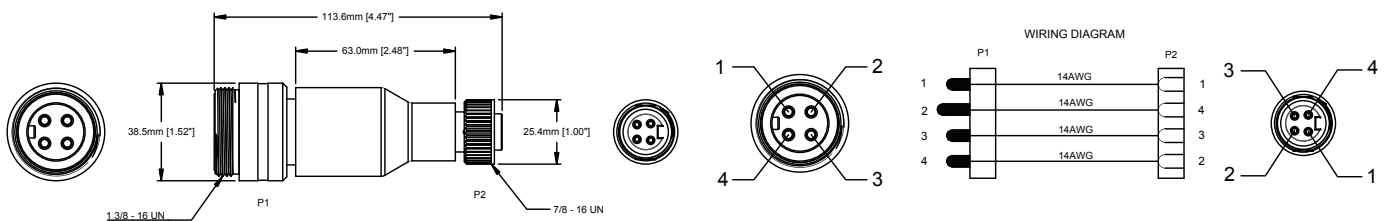

FIG 20: In-Line Reducers 4 Positions



All Dimensions in: mm [inch]



PowerBOSSlite™ M22

Power Distribution System



PowerBOSSlite™ M22 (7/8") Specifications

| | | | |
|-------------------|--|--------------------|---------------------------------------|
| Temperature Range | -20°C to +90°C Single-rated/-20°C to +105°C Dual-rated | Contact Plating | 5µ" (min) Gold over 25µ" (min) Nickel |
| Body | Oil resistant PVC | Connector Face | PVC |
| Contacts | Copper Alloy | Coupler Housing | Machined Aluminum, Anodized |
| Protection | IP67, NEMA 6P | Receptacle Housing | Machined Aluminum, Anodized |























| Single and Dual Rating Specifications | | | | |
|---------------------------------------|---|--|--|------------------------|
| Cable Drop - Single-rated | PVC insulated #14AWG stranded copper (41 x 30) | TC-ER Only: UL Listed; FT-4 Flame Rating | 600V, 90°C Dry/Wet | Black TPE Cable Jacket |
| Cable Drop - Dual-rated | PVC insulated #14AWG stranded copper (105 x 34) | TC-ER/STOOW; UL listed; FT2; CSA certified type STOOW | 600V, 90°C Dry/75°C Wet (TC-ER), 105°C (STOOW) | Black PVC Cable Jacket |

M22 (7/8") - 3 and 4 Position Drop/Branch Cable Assemblies

Mxxx = length in meters

| | 3 Pos. (Drop/Branch); 600V; 15A; 14AWG | | 4 Pos. (Drop/Branch); 600V; 15A; 14AWG |
|---|---|-------------|--|
| Cable Diameter | 0.37" (9.4mm) Single-rated 0.53" (13.5mm) Dual-rated | | 0.40" (10.2mm) Single-rated 0.57" (14.5mm) Dual-rated |
| Color Code | 1-Green, 2-Black, 3-White | | 1-Black, 2-White, 3-Red, 4-Green |
| Overmold Colors | Black | Red | Black |
| Male Straight, Single-rated (See FIG 1, Pg 30) | P30776-Mxxx | P30890-Mxxx | P30760-Mxxx |
| Male 90, Single-rated (See FIG 3, Pg 30) | P30777-Mxxx | P30893-Mxxx | P30761-Mxxx |
| Female Straight, Single-rated (See FIG 2, Pg 30) | P30778-Mxxx | P30891-Mxxx | P30762-Mxxx |
| Female 90, Single-rated (See FIG 4, Pg 30) | P30779-Mxxx | P30894-Mxxx | P30763-Mxxx |
| Male Straight, Dual-rated (See FIG 1, Pg 30) | P29020-Mxxx | | P29016-Mxxx |
| Male 90, Dual-rated (See FIG 3, Pg 30) | P29021-Mxxx | | P29017-Mxxx |

M22 (7/8") - 3 and 4 Position Drop/Branch Cable Assemblies, cont. Mxxx = length in meters

| | 3 Pos. (Drop/Branch); 600V; 15A; 14AWG | | 4 Pos. (Drop/Branch); 600V; 15A; 14AWG |
|---|--|---|--|
| Cable Diameter | 0.37" (9.4mm) Single-rated 0.53" (13.5mm) Dual-rated | | 0.40" (10.2mm) Single-rated 0.57" (14.5mm) Dual-rated |
| Color Code | 1-Green, 2-Black, 3-White | | 1-Black, 2-White, 3-Red, 4-Green |
| Overmold Colors | Black | Red | Black |
| Female Straight, Dual-rated (See FIG 2, Pg 30) |  P29022-Mxxx | - |  P29018-Mxxx |
| Female 90, Dual-rated (See FIG 4, Pg 30) |  P29023-Mxxx | - |  P29019-Mxxx |
| Male Straight/ Female Straight, Single-rated (See FIG 1 and 2, Pg 30) |  P30772-Mxxx |  P30889-Mxxx |  P30756-Mxxx |
| Male Straight/ Female 90, Single-rated (See FIG 1 AND 4, Pg 30) |  P30773-Mxxx |  P30895-Mxxx |  P30757-Mxxx |
| Male 90/ Female Straight, Single-rated (See FIG 2 and 3, Pg 30) |  P30774-Mxxx |  P30896-Mxxx |  P30758-Mxxx |
| Male 90/ Female 90, Single-rated (See FIG 3 and 4, Pg 30) |  P30775-Mxxx |  P30892-Mxxx |  P30759-Mxxx |
| Male Straight/ Female Straight, Dual-rated (See FIG 1 and 2, Pg 30) |  P29012-Mxxx |  P30254-Mxxx |  P29008-Mxxx |
| Male Straight/ Female 90, Dual-rated (See FIG 1 and 4, Pg 30) |  P29013-Mxxx | - |  P29009-Mxxx |
| Male 90/ Female Straight, Dual-rated (See FIG 2 and 3, Pg 30) |  P29014-Mxxx | - |  P29010-Mxxx |

PowerBOSSlite™ M22 (7/8")

PowerBOSSlite™ M22



M22 (7/8") - 3 & 4 Position Drop/Branch Cable Assemblies, cont. Mxxx = length in meters

| | 3 Pos. (Drop/Branch); 600V; 15A; 14AWG | 4 Pos. (Drop/Branch); 600V; 15A; 14AWG |
|---|---|--|
| Cable Diameter | 0.37" (9.4mm) Single-rated 0.53" (13.5mm) Dual-rated | 0.40" (10.2mm) Single-rated 0.57" (14.5mm) Dual-rated |
| Color Code | 1-Green, 2-Black, 3-White | |
| Overmold Colors | Black | Red |
| Male 90/ Female 90, Dual-rated (See FIG 3 and 4, Pg 30) | P29015-Mxxx | P29011-Mxxx |
| M-Str/F-HAN Q4/2, Dual-rated (See FIG 1, Pg 30) *UL Approval Pending As An Assembly | - | P30746-Mxxx |

M22 (7/8") - 3 & 4 Position Drop/Branch Receptacles Mxxx = length in meters

| | 3P Drop/Branch | 4P Drop/Branch |
|---|---------------------------|----------------------------------|
| Voltage/Current | 600V/15A | 600V/15A |
| Conductor | 14AWG | 14AWG |
| Color Code | 1-Green, 2-Black, 3-White | 1-Black, 2-White, 3-Red, 4-Green |
| Male, External Threading (See FIG 5, Pg 30) | P29038-Mxxx | P29036-Mxxx |
| Female, Internal Threading (See FIG 6, Pg 30) | P29039-Mxxx | P29037-Mxxx |
| Male, M20 Threading (See FIG 7, Pg 30) | - | P30727-Mxxx |

M22 (7/8") - Accessories

All Dimensions in: mm [inch]

| M22, Dustcap, Metal, Male Drop w Internal Threads | P29044 | M22, Dustcap, Metal, Female Drop w External Threads | P29045 | M22, Locking Clip, Drop | P29041 |
|--|--------|--|--------|-------------------------|--------|
| | | | | | |

Dimensional Drawings

FIG 1: Male, Plug, Straight, Drop/Branch, 3 and 4 Position

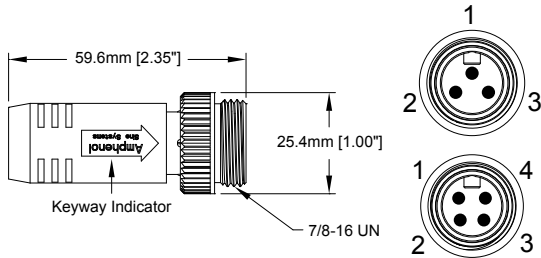

FIG 2: Female, Plug, Straight, Drop/Branch, 3 and 4 Position

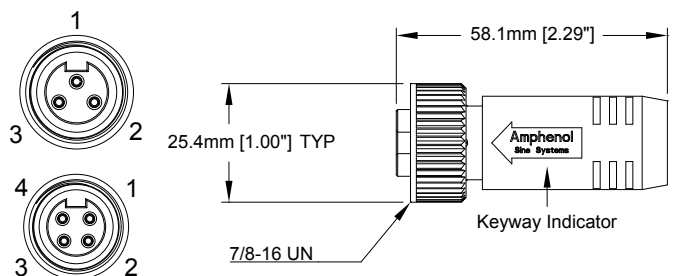

FIG 3: Male, Plug, 90°, Drop/Branch, 3 and 4 Position

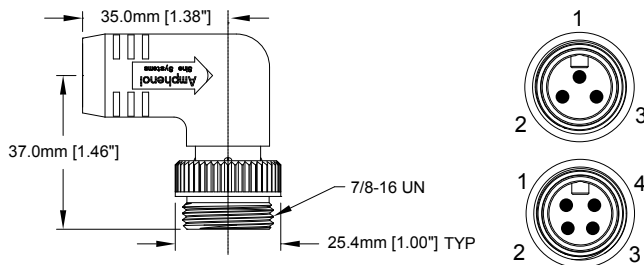

FIG 4: Female, Plug, 90°, Drop/Branch, 3 and 4 Position

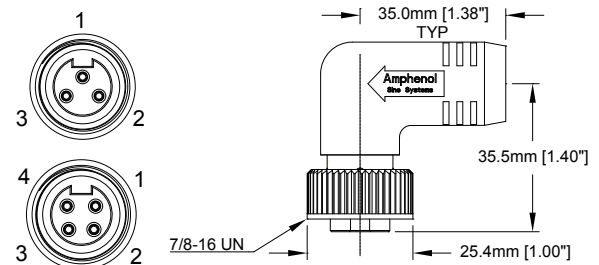

FIG 5: Male, Receptacle, Straight, Drop, 3 and 4 Position

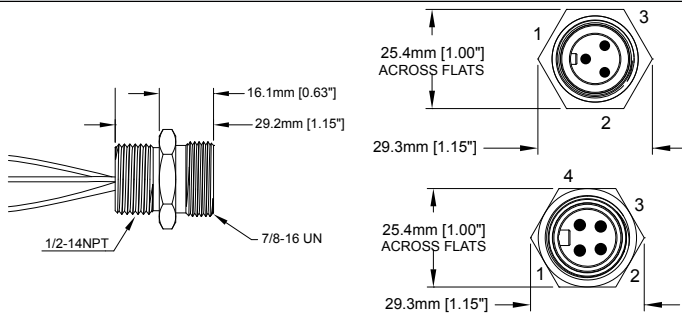

FIG 6: Female, Receptacle, Straight, Drop, 3 and 4 Position

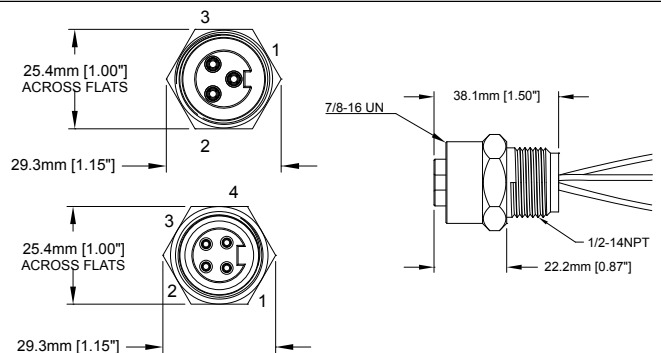
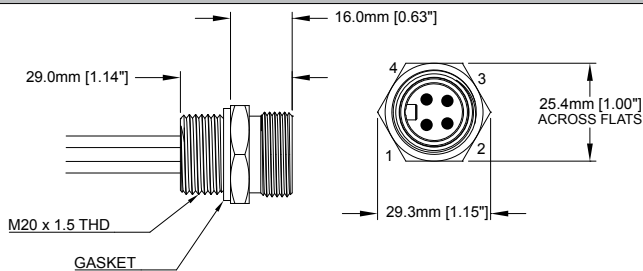

FIG 7: Male, Receptacle, M20 Threading, Straight, Drop, 4 Position



All Dimensions in: mm [inch]

This page intentionally left blank.

PowerBOSS™ M40

featuring

Check Mate™

Advanced Interconnect System



Easy 'Plug & Play' Installation • Scalable • Easy to Repeat
 Faster Install & Labor Times • Faster to Market Time • Less Downtime
 Increased Worker Productivity • Elimination of Specialized Tooling
 Reduced Maintenance, Manufacturing and Labor Costs

(This layout includes our VersaBOSS™ product line. Please reference pages 68-84 for product specifics.)



Trunk **TEE** connectors provide 'plug & play' daisy-chained connectivity which is ideal for splitting main power trunk.



TERMINATOR PLUGS provide a convenient, safe way to seal the end of a line, or "stop point", which complete the "safety circuit".



Color-coded **VersaBOSS™ RECEPTACLES** offer quick-connect interface to the device or cabinet.



Color-coded, crush-resistant, overmolded **VersaBOSS™ CONNECTORS** with standard 3 Power + PE/5 Signal contacts. Allows up to 20A while controlling Signal, Brake or Thermal at 5A.



Crush-resistant 'Trunk' and 'Drop' **CONNECTORS** provide quick disconnects for fast installations and contain accessories to prevent accidental disconnection.

Tray-rated, exposed-run cable meets code requirements and replaces hard-wiring and conduit.



Traditional **RECEPTACLES** offer quick-connect interface to the device or cabinet.

Custom Solutions

We offer custom solutions to meet your specific needs. Contact one of our Sales Representatives at +1 800 394 7732.

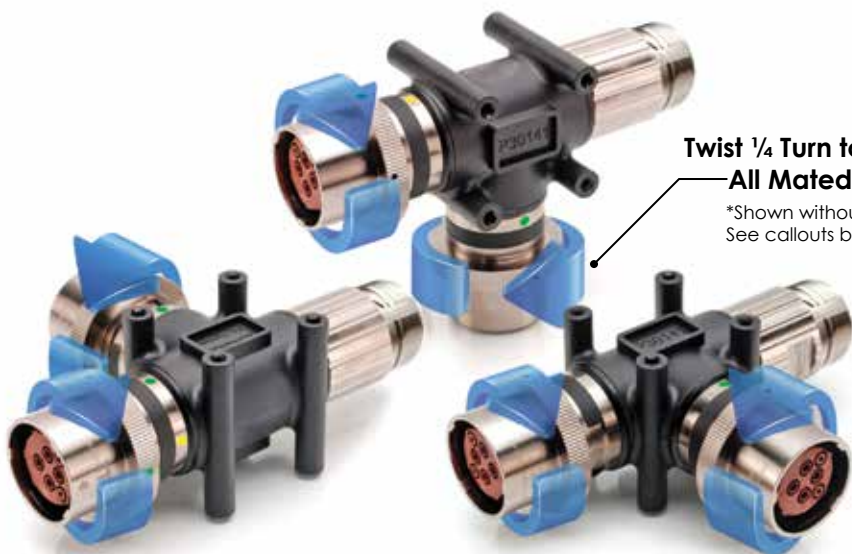

**Twist 1/4 Turn to Lock/Unlock
All Mated Connections***

*Shown without GuardSafe™ Clips or Safety Sleeves for clarity.
See callouts below.

**4 + 2
Connector Layout**

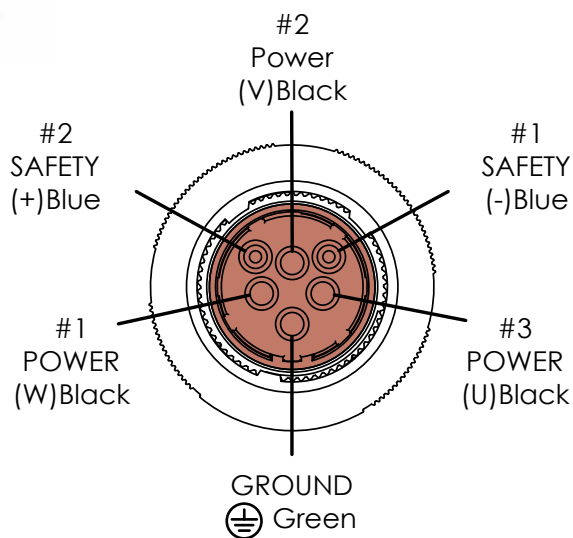

GuardSafe™ Clip Assemblies (PN:10-80249)
Standard on Checkmate™ Products
(To Prevent Accidental Unmating
of Connections.)



This page intentionally left blank.

M40 featuring Checkmate™ - 6 Position Specifications











| | | | |
|-----------------------|---|-------------------------|----------------------------|
| Temperature Range | -20°C to 105°C | Dielectric Test Voltage | 2200V |
| Coupling Nut | Machined Aluminum, Anodized | Protection | IP67 (Mated Condition) |
| Insulation Insert | Thermoplastic, UL 94/V-0 | Mating Cycles | >500 |
| Contact | Gold Flash Plating over Copper Alloy | Vibration Resistance | Per MIL-STD-202 Method 204 |
| Bend Radius Limiter | Thermoplastic, Black | Thermal Shock | Per MIL-STD-202 Method 207 |
| Cable Jacket Material | Available in PVC or TPE | 48 Hour Salt Spray | Per MIL-STD-202 Method 101 |
| Insulation Resistance | 5000M OHMS | Short Circuit Rating | 65kA |
| NFPA-79 | Meets standards for motor/branch circuits | | |

| Cable Trunk Rating Specifications | | | | |
|-----------------------------------|---|---|---|-------------------------|
| Single-rated | PVC insulated, 10AWG stranded copper (105 x 30) | TC-ER Only UL Listed; FT-4 Flame Rating | 600V, 90°C Dry/Wet | Black TPE Cable Jacket |
| | PVC insulated, 14AWG stranded copper (105 x 34) | | | |
| | PVC insulated, 8AWG stranded copper (7 x 19 x 29) | | | |
| Dual-rated | PVC insulated, 14AWG stranded copper (105 x 34) | TC-ER Only UL Listed; FT-4 Flame Rating | 600V, 90°C Dry/Wet | Black TPE Cable Jacket |
| | PVC insulated, 10AWG stranded copper (105 x 30) | | | |
| | PVC insulated, 14AWG stranded copper (105 x 34) | | | |
| | PVC insulated, 8AWG stranded copper (7 x 19 x 29) | | | |
| High Flex | PVC insulated, 10AWG stranded copper (105 x 30) | TC-ER/STOOW; UL listed; FT2; CSA certified type STOOW | 600V, 90°C Dry/75°C Wet (TC-ER) 105°C (STOOW) | Black PVC Cable Jacket |
| | PVC insulated, 14AWG stranded copper (105 x 34) | | | |
| | PVC insulated, 14AWG stranded copper (105 x 34) | | | |
| High Flex | PVC insulated, 10AWG stranded copper (105 x 30) | TC-ER/STOOW; UL listed; FT2; CSA certified type STOOW | 600V, 90°C Dry/75°C Wet (TC-ER) 105°C (STOOW) | Black PVC Cable Jacket |
| | PVC insulated, 16AWG stranded copper (65 x 34) | | | |
| High Flex | PVC insulated, 10AWG stranded copper (105 x 30) | TC-ER Only UL Listed; FT-4 Flame Rating | 600V, 90°C Dry/Wet | Yellow TPE Cable Jacket |
| | PVC insulated, 16AWG stranded copper (65 x 34) | | | |

The Industrial@Amphenol products found within this section are UL 2237 Listed for the amperage ratings provided. However, for higher amperage requirements with governances outside of this specific UL listing, please consult your salesperson as higher amperage values may be applicable.

M40 featuring Checkmate™ - 6 Position Cable Assemblies

Mxxx = length in meters

| | 6 Pos.; 600V; Power 32A, Signal 5A | 6 Pos.; 600V; Power 25A, Signal 5A |
|--|--|--|
| Color Code (Ref. Pg 34) | U - Black, V - Black, W - Black, Ground - Green, "+" - Blue, "-" - Blue, Shield | |
| Number of Contacts | 4C 8AWG x 1 Shielded 14AWG Pair | 4C 10AWG x 1 Shielded 14AWG Pair |
| Male Straight, TPE Jacket, Single-rated, Black (See FIG 1, Pg 39) |  P30668-Mxxx |  P30671-Mxxx |
| Female Straight, TPE Jacket, Single-rated, Black (See FIG 2, Pg 39) |  P30669-Mxxx |  P30672-Mxxx |
| Male Straight, TPE Jacket, Single-rated, High Flex Cable, Yellow (See FIG 1, Pg 39) | - |  P30241-Mxxx |
| Female Straight, TPE Jacket, Single-rated, High Flex Cable, Yellow (See FIG 2, Pg 39) | - |  P30242-Mxxx |
| Male Straight, PVC Jacket, Dual-rated, Black (See FIG 1, Pg 39) |  P30237-Mxxx |  P30239-Mxxx |
| Female Straight, PVC Jacket, Dual-rated, Black (See FIG 2, Pg 39) |  P30238-Mxxx |  P30240-Mxxx |



M40 featuring Checkmate™ - 6 Position Cable Assemblies, cont. Mxxx = length in meters

| | 6 Pos.; 600V; Power 32A, Signal 5A | 6 Pos.; 600V; Power 25A, Signal 5A |
|---|--|--|
| Color Code (Ref. Pg 34) | U - Black, V - Black, W - Black, Ground - Green, "+" - Blue, "-" - Blue, Shield | |
| Number of Contacts | 4C 8AWG x 1 Shielded 14AWG Pair | 4C; 10AWG x 1 Shielded 14AWG Pair |
| Male/Female Straight, TPE Jacket, Single-rated, Black (See FIG 3, Pg 39) |  P30667-Mxxx |  P30670-Mxxx |
| Male/Female Straight, TPE Jacket, Single-rated, High Flex Cable, Yellow (See FIG 3, Pg 39) | - |  P30189-Mxxx |
| Male/Female Straight, PVC Jacket, Dual-rated, Black (See FIG 3, Pg 39) |  P30142-Mxxx |  P30143-Mxxx |

M40 featuring Checkmate™ - 6 Position Receptacles Mxxx = length in meters



| | 6 Pos.; 600V; 32A Power, 5A Signal | | |
|---------------------------------------|--|---|--|
| Color Code (Ref. Pg 34) | U - Black, V - Black, W - Black, Ground - Green, "+" - Blue, "-" - Blue, Shield | | |
| Number of Contacts | 4C 8AWG x 2 Conductor 14AWG | 4C 10AWG x 2 Conductor 14AWG | 4C 10AWG x 2 Conductor 14AWG (w/ M25 Adapter) |
| Male Straight (See FIG 4, Pg 39) |  P30256-Mxxx |  P30257-Mxxx |  P30163-Mxxx |
| Female Straight (See FIG 5, Pg 39) |  P30146-Mxxx |  P30147-Mxxx | - |

M40 featuring Checkmate™ - 6 Position Tees

| | Standard | Angled Leg |
|--|---|---|
| Voltage/Current | 600V/32A | |
| Trunk to Trunk (See FIG 7 and 8, Pg 40) |  P30141 |  P30715 |

All Dimensions in: mm [inch]

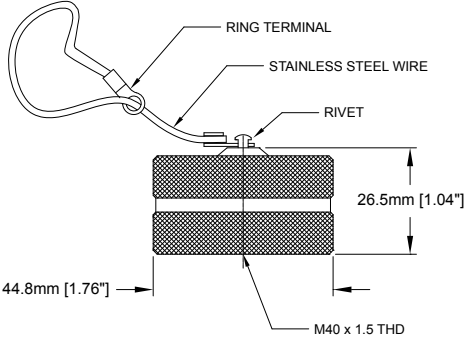
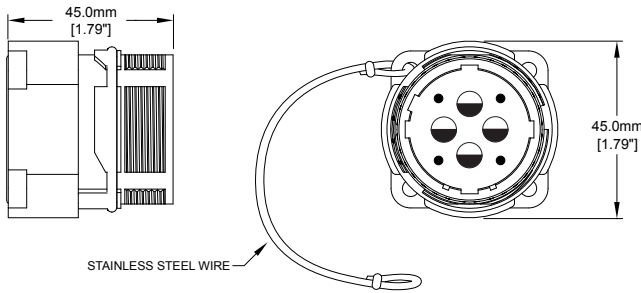
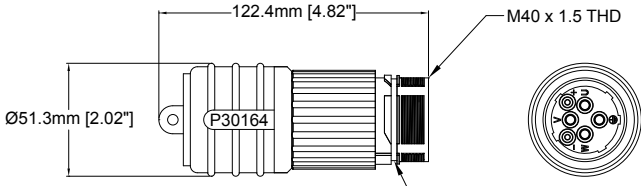
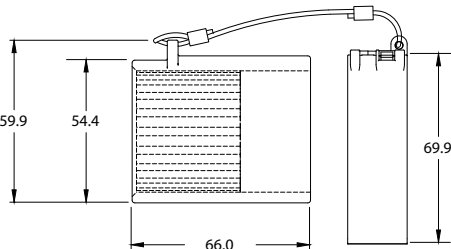
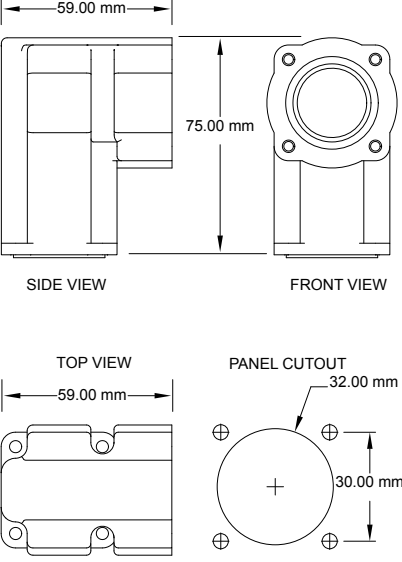
M40 featuring Checkmate™ - Accessories

| | | | |
|--|--|---|-----------------|
| <p>M40, Checkmate™, Dustcap for Male Connector</p> | <p>P29851</p> | <p>M40, Checkmate™, "Potted" Dustcap for Female Connector</p> | <p>P30510</p> |
|  |  | | |
| <p>M40, Checkmate™, 6 Pos., Terminator Plug with O-Ring</p> | <p>P30164</p> | <p>M40, Checkmate™, Safety Sleeve and Clip Assembly</p> | <p>10-80249</p> |
|  |  | | |
| <p>M40, Checkmate™, 90° Mounting Adapter</p> | <p>34-80289</p> | | |
|  |  | | |

All Dimensions in: mm [inch]

Dimensional Drawings

FIG 1: Male, Plug, Straight, 6 Position

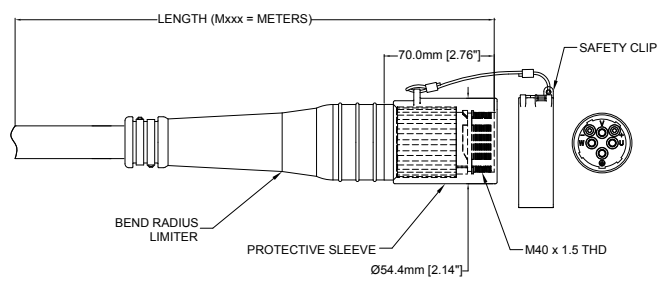

FIG 2: Female, Plug, Straight, 6 Position

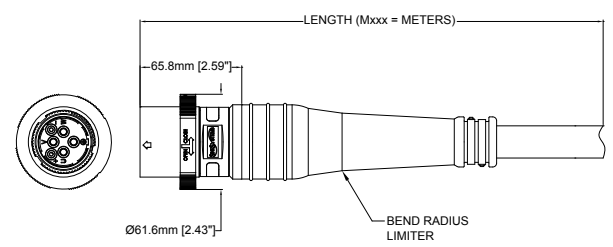

FIG 3: Male to Female, Plug, Straight, 6 Position

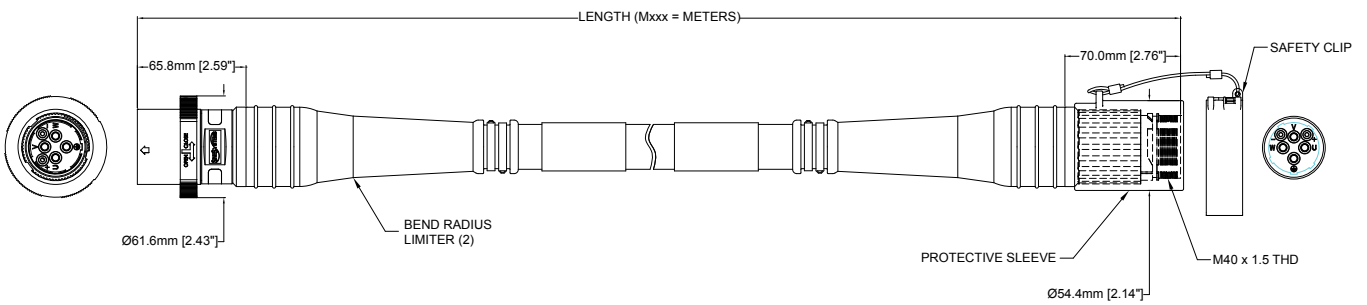

FIG 4: Male, Straight, Receptacle

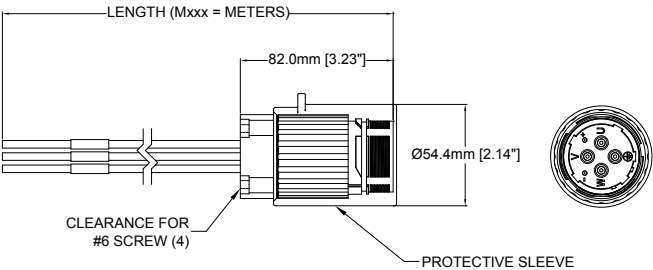

FIG 5: Female, Straight, Receptacle

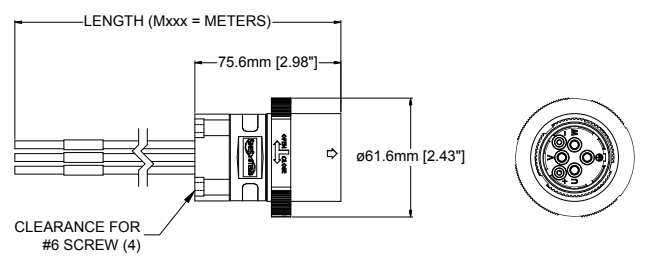
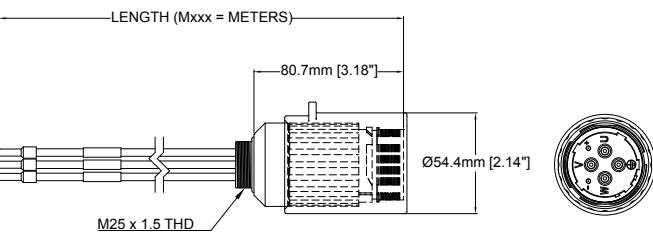

FIG 6: Male, 10AWG, Receptacle w/ M25 Threaded Adapter



All Dimensions in: mm [inch]

Dimensional Drawings, cont.

FIG 7: Tee, Standard, Black

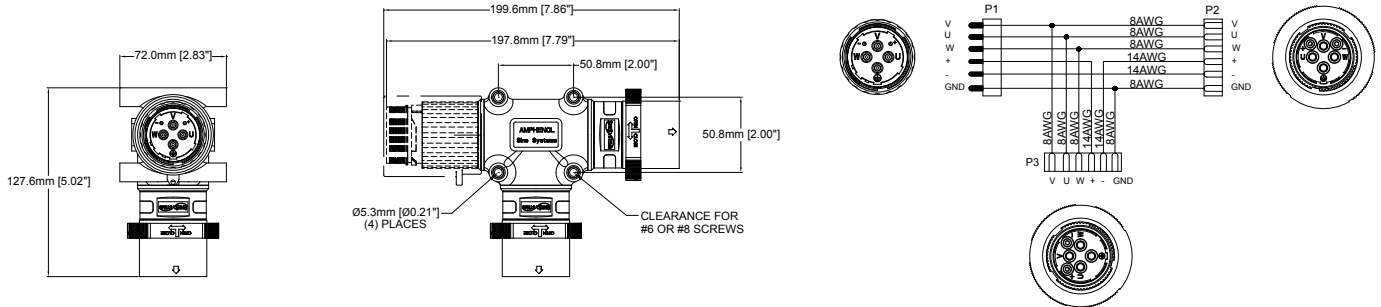
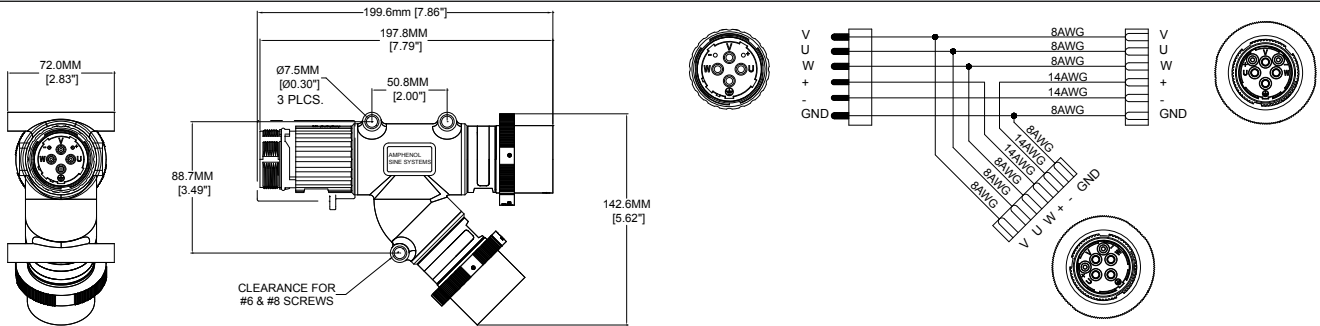

FIG 8: Tee, Angled Leg, Black



All Dimensions in: mm [inch]

This page intentionally left blank.

M40 - 6 Position Specifications



| | | | |
|-----------------------|---|-------------------------|----------------------------|
| Temperature Range | -20°C to 105°C | Dielectric Test Voltage | 2200V |
| Coupling Nut | Machined Aluminum, Anodized | Protection | IP67 (Mated Condition) |
| Insulation Insert | Thermoplastic, UL 94/V-0 | Mating Cycles | >500 |
| Contact | Gold Flash Plating over Copper Alloy | Vibration Resistance | Per MIL-STD-202 Method 204 |
| Bend Radius Limiter | Thermoplastic, Black | Thermal Shock | Per MIL-STD-202 Method 207 |
| Cable Jacket Material | Available in PVC or TPE (See below) | 48 Hour Salt Spray | Per MIL-STD-202 Method 101 |
| Insulation Resistance | 5000M OHMS | Short Circuit Rating | 65kA |
| NFPA-79 | Meets standards for motor/branch circuits | | |

| Cable Trunk Rating Specifications | | | | |
|---|---|---|---|------------------------|
| Single-rated | PVC insulated, 10AWG stranded copper (105 x 30) | TC-ER Only UL Listed; FT-4 Flame Rating | 600V, 90°C Dry/Wet | Black TPE Cable Jacket |
| | PVC insulated, 14AWG stranded copper (105 x 34) | | | |
| | PVC insulated, 8AWG stranded copper (7 x 19 x 29) | TC-ER Only UL Listed; FT-4 Flame Rating | 600V, 90°C Dry/Wet | Black TPE Cable Jacket |
| PVC insulated, 14AWG stranded copper (105 x 34) | | | | |
| Dual-rated | PVC insulated, 10AWG stranded copper (105 x 30) | TC-ER/STOOW; UL listed; FT2; CSA certified type STOOW | 600V, 90°C Dry/75°C Wet (TC-ER) 105°C (STOOW) | Black PVC Cable Jacket |
| | PVC insulated, 14AWG stranded copper (105 x 34) | | | |
| | PVC insulated, 8AWG stranded copper (7 x 19 x 29) | TC-ER/STOOW; UL listed; FT2; CSA certified type STOOW | 600V, 90°C Dry/75°C Wet (TC-ER) 105°C (STOOW) | Black PVC Cable Jacket |
| PVC insulated, 14AWG stranded copper (105 x 34) | | | | |

The Industrial@Amphenol products found within this section are UL 2237 Listed for the amperage ratings provided. However, for higher amperage requirements with governances outside of this specific UL listing, please consult your salesperson as higher amperage values may be applicable.



M40 - 6 Position Cable Assemblies

Mxxx = length in meters

| | 6 Pos.; 600V; Power 32A, Signal 5A | 6 Pos.; 600V; Power 25A, Signal 5A | 6 Pos.; 600V; Power 20A, Signal 5A |
|--|--|---|--|
| Color Code (Ref. Pg 34) | U - Black, V - Black, W - Black, Ground - Green, "+" - Blue, "-" - Blue, Shield | | |
| Number of Contacts | 4C 8AWG x 1 Shielded 14AWG Pair | 4C 10AWG x 1 Shielded 14AWG Pair | 4C 12AWG x 1 Shielded 14AWG Pair |
| Cable O.D. | 27.7 (1.09) | 24.0 (0.945) | 11.7 (.46) |
| Male Straight, Female Straight, Dual-rated (See FIG 1, Pg 44) |  P29844-Mxxx |  P29950-Mxxx | - |
| Male Straight/ Female HAN Q4/2, Single-rated (See FIG 2, Pg 44) *UL Approval Pending As An Assembly | - | - |  P30066-Mxxx |

M40 - 6 Position Receptacles

Mxxx = length in meters

| | 6 Po.; 600V; 32A Power, 5A Signal | |
|------------------------------------|--|--|
| Color Code (Ref. Pg 34) | U - Black, V - Black, W - Black, Ground - Green, "+" - Blue, "-" - Blue, Shield | |
| Number of Contacts | 4C 8AWG x 2 Conductor 14AWG | 4C 8AWG x 2 Conductor 14AWG (w/ 8AWG Leads) |
| Female Straight (See FIG 3, Pg 44) |  P29848-Mxxx |  P29954-Mxxx |

M40 - 6 Position Tees

| | 6 Pos.; 600V; 32A Power, 5A Signal |
|------------------------------------|--|
| Standard, Black (See FIG 4, Pg 44) |  P29841 |

PowerBOSS™ M40

M40 - Accessories

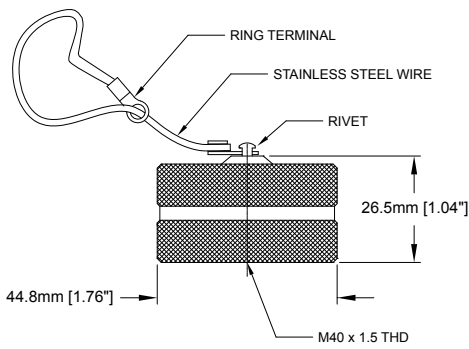
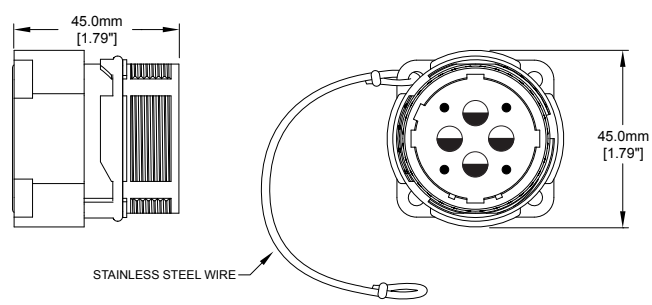
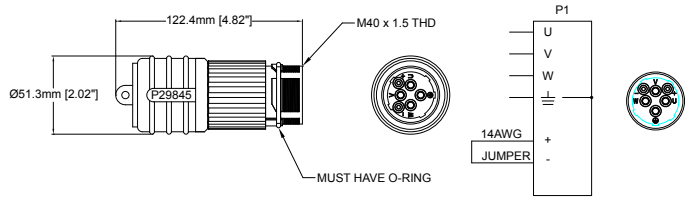
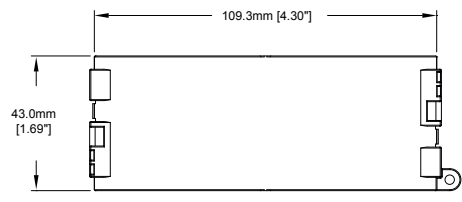
| M40, Dustcap for Male Connector | P29851 | M40, "Potted" Dustcap for Female Connector | P30510 |
|---|--|--|--------|
|  |  | | |
| M40, 6 Pos., Terminator Plug | P29845 | M40, Locking Ring w/ Lanyard | P29850 |
|  |  | | |

All Dimensions in: mm [inch]

Dimensional Drawings

FIG 1: Male to Female, Plug, Straight, 6 Position

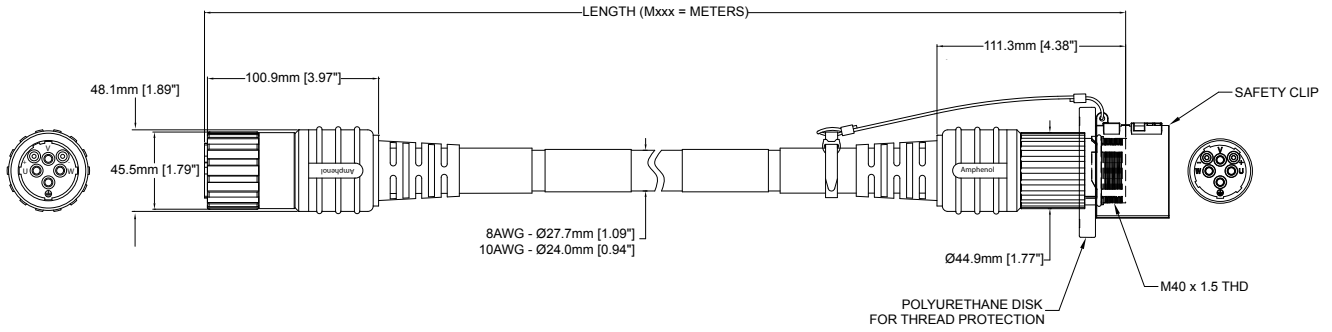

FIG 2: Male Plug to HAN Q4/2 Female Plug

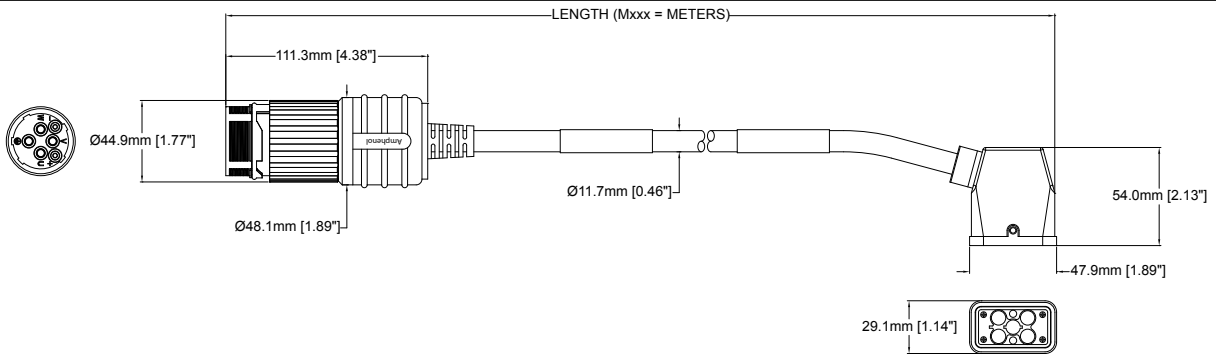

FIG 3: Female, Straight, Receptacle

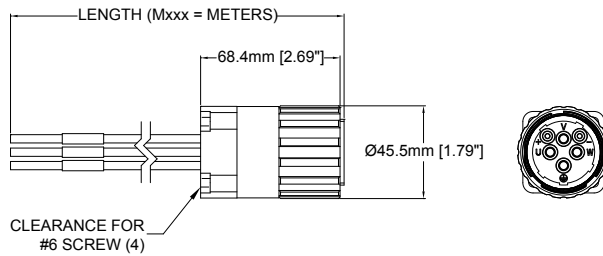
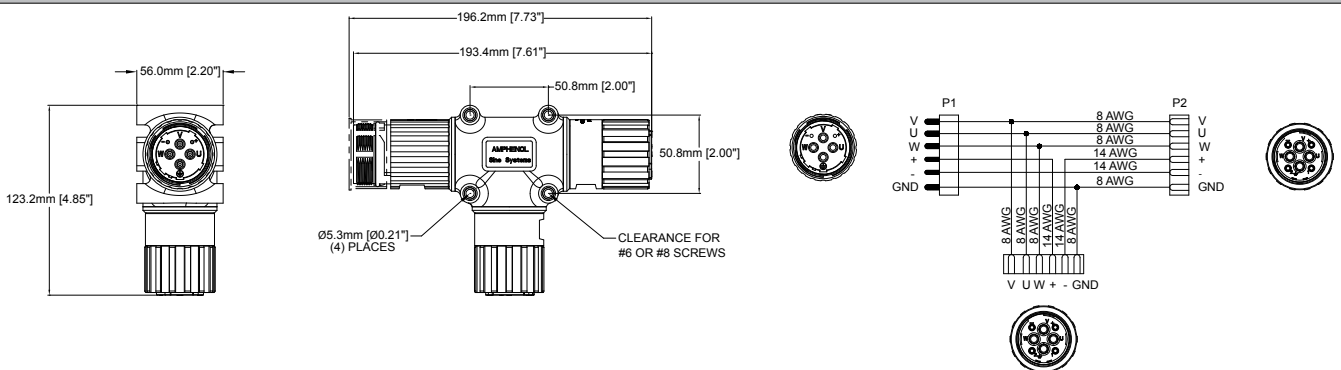

FIG 4: Tee, Standard, Black



All Dimensions in: mm [inch]

This page intentionally left blank.

PowerBOSS™

Power & Control Distribution System



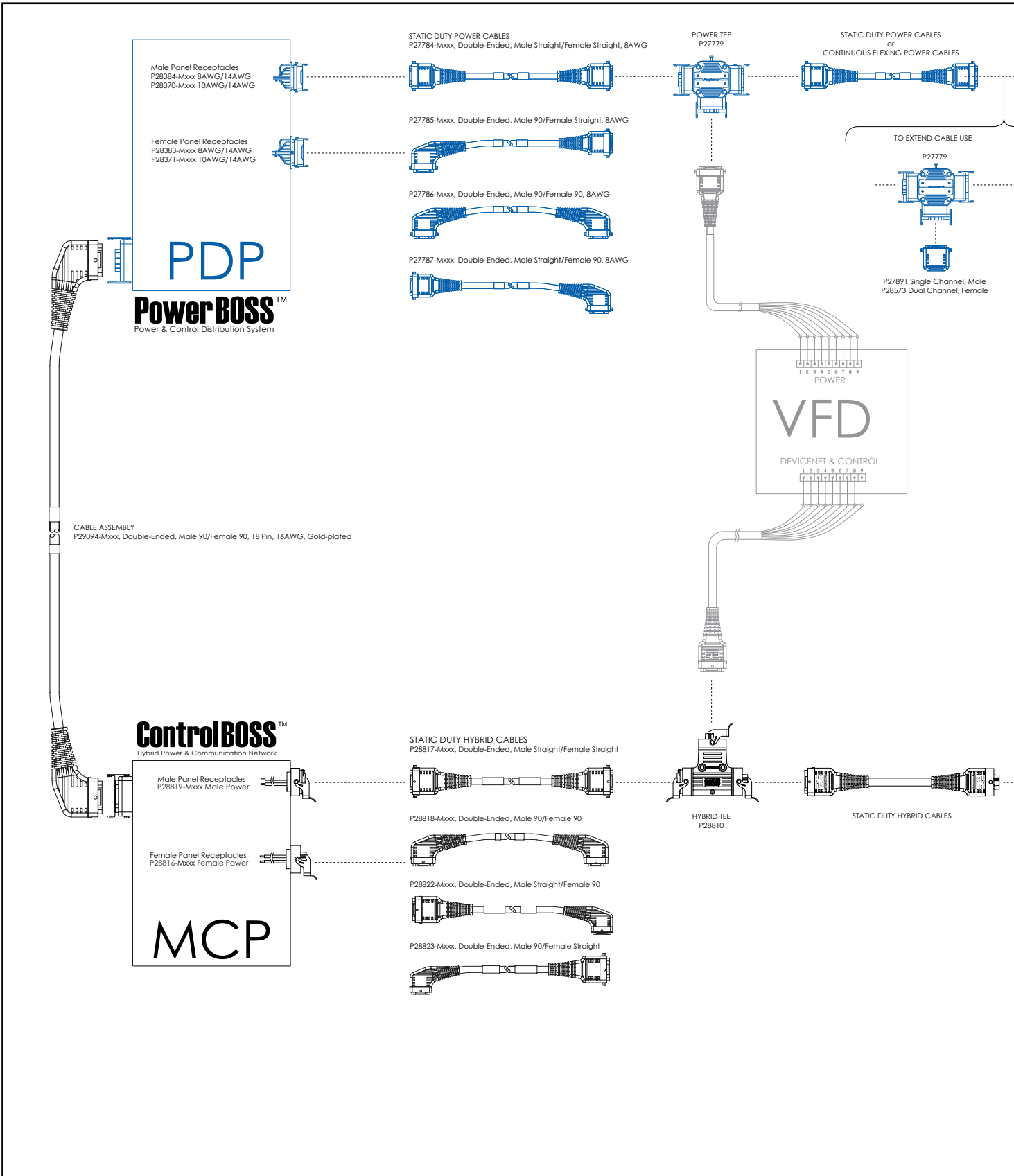

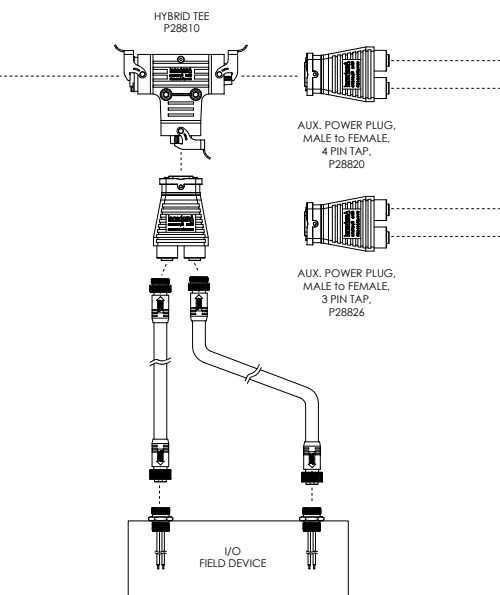
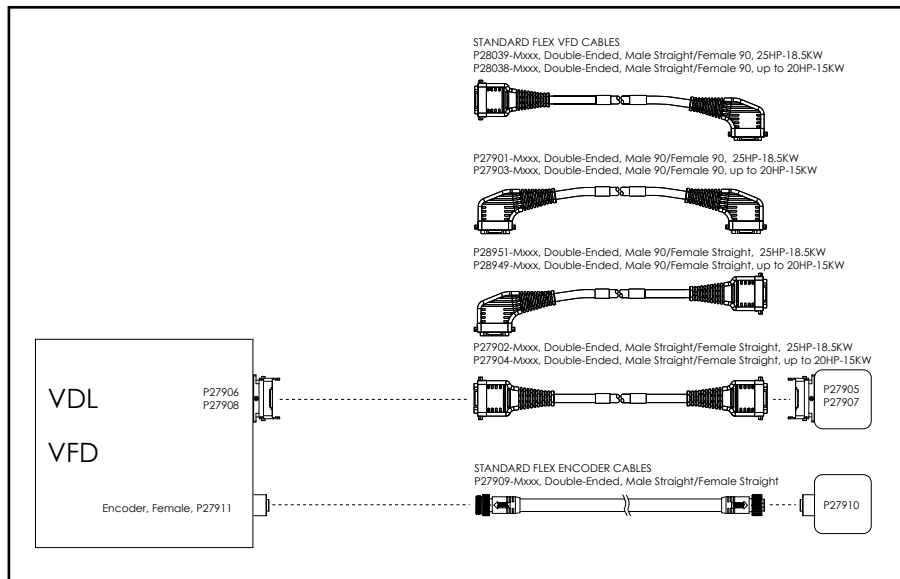
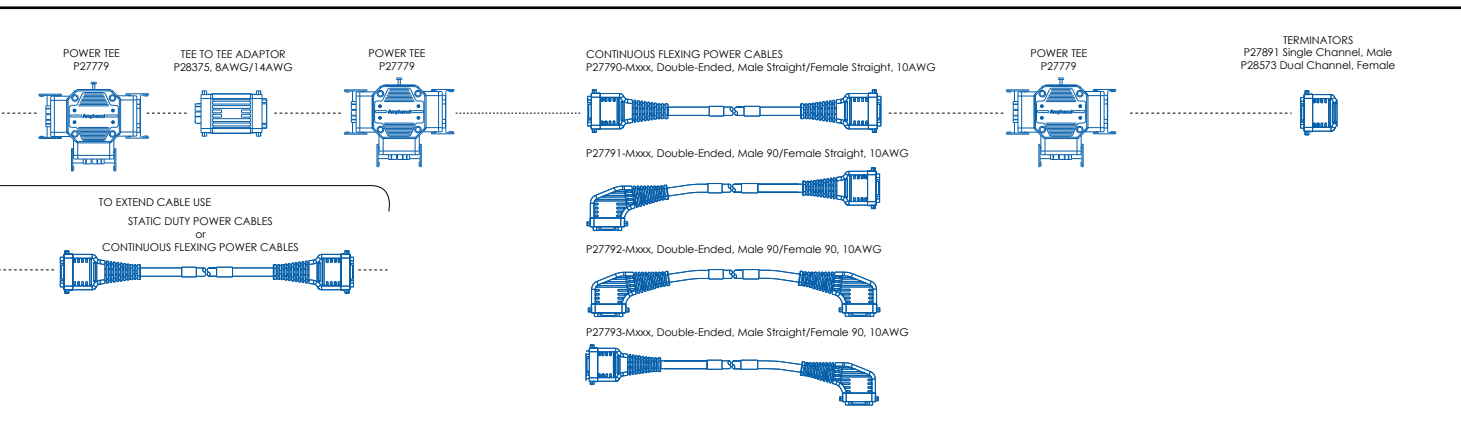

TO VDL, SHUTTLE, ETC.

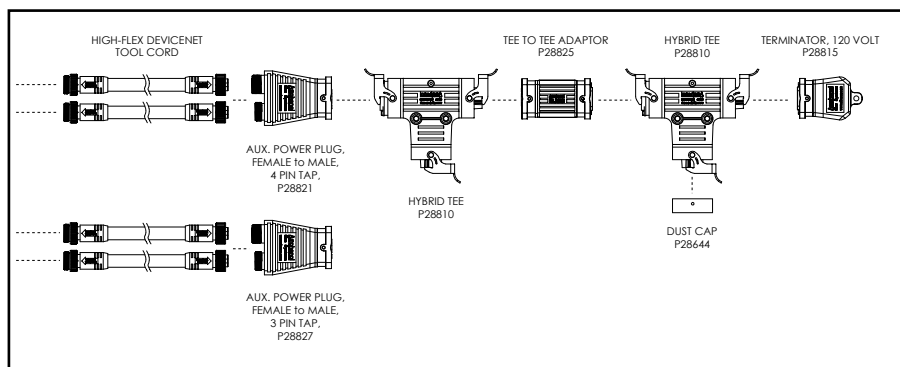

PowerBOSS™ and ControlBOSS™
Typical Architecture

INDUSTRIAL@AMPHENOL
TRUSTED GLOBALLY

Amphenol Sine Systems

PowerBOSS™



The PowerBOSS™ System includes 4 primary conductors and 2 individually shielded pairs of 14AWG. One pair is typically used as a cable connection monitor and is connected to a single channel safety relay which controls redundant contactors in case someone has removed the locking device and disconnects the cable. The safety relay will de-energize the cable before the power contacts are open ensuring no arch flash occurs.

The second pair of conductors are typically used for dual-channel safety operations, or can be defined by the user. Both pairs are 100% shielded from the power so that no induction can occur.

- 600V/40A • Easy 'Plug & Play' Installation • Scalable • Easy to Repeat
- Faster Install & Labor Times • Faster to Market Time • Less Downtime
- Increased Worker Productivity • Elimination of Specialized Tooling
- Reduced Maintenance, Manufacturing and Labor Costs
- Delivers power through buss and drop connectors in 8-12AWG

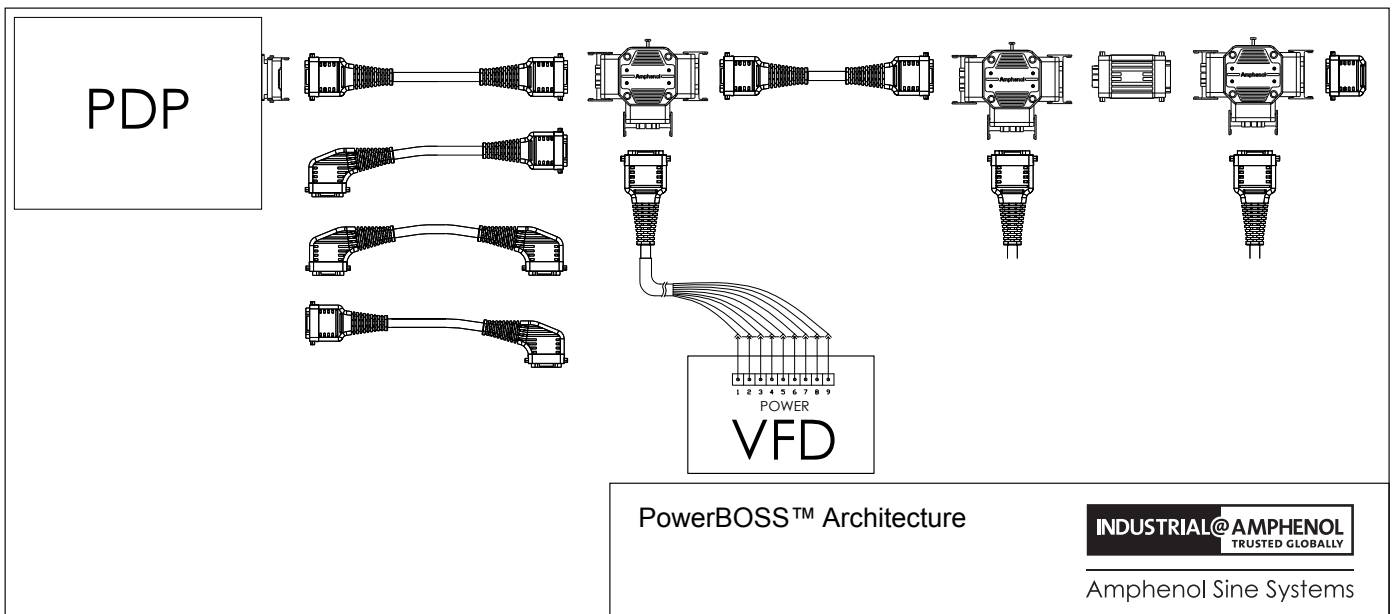

PowerBOSS™ Specifications

| | |
|---|---|
| Two stage over-molded cable assemblies | Strong Thermoplastic 9 Pin contact housing |
| Oil and chemical resistant PVC jacket and molding compounds | UL and CSA listed; UL Type TC-ER |
| IP67 | CSA AWM I/II A/B, 600 Volt FT4 |
| Uni-Directional cable strain relief | 600 Volt AC |
| Vibration resistant coupling system | Open wiring rated |
| Silver and gold plated contact offering | Operating temperature - 25°C to 90°C |
| Heavy duty aluminum die cast shell | Stationary and continuous flexing cable options |



9 Position Cable Assemblies and Receptacles

Exxx = length in feet
Mxxx = length in meters

| 9 Pos.; 600V; 40A Power, 10A Signal | |
|-------------------------------------|--|
| Wiring Diagram | |
| Number of Contacts | 3/4 + PE + Shield |
| Cavities 6-9 | Cavities 6-9 contacts are last mate/first break. Cavity 2 contact is first mate/last mate ground |

| Static Plugs | See FIG/Page | 8-14AWG | 10-14AWG |
|---------------------|--------------|-------------|-------------|
| Male Str/Female Str | FIG 1, Pg 52 | P27784-Mxxx | P28559-Mxxx |
| Male 90°/Female Str | FIG 2, Pg 52 | P27785-Mxxx | P28560-Mxxx |
| Male Str/Female 90° | FIG 3, Pg 52 | P27787-Mxxx | P28562-Mxxx |
| Male 90°/Female 90° | FIG 4, Pg 52 | P27786-Mxxx | P28561-Mxxx |

| Continuous Flex Plugs | See FIG/Page | 8-16AWG | 10-14AWG |
|-----------------------|--------------|-------------|----------|
| Male Str/Female Str | FIG 1, Pg 52 | P27790-Mxxx | - |
| Male 90°/Female Str | FIG 2, Pg 52 | P27791-Mxxx | - |
| Male Str/Female 90° | FIG 3, Pg 52 | P27793-Mxxx | - |
| Male 90°/Female 90° | FIG 4, Pg 52 | P27792-Mxxx | - |

| Panel Receptacles | See FIG/Page | 8-14AWG | 10-14AWG |
|-------------------|--------------|-------------|-------------|
| Male Power | FIG 5, Pg 52 | P27797-Mxxx | P28572-Mxxx |
| Female Power | FIG 6, Pg 52 | P27796-Mxxx | P28571-Mxxx |

PowerBOSS™



Tees

| Description | See FIG/Page | Part Number |
|--------------------------------|--------------|-------------|
| Power Tee, 9 Pos., 600V | FIG 7, Pg 53 | P27779 |
| Dual Channel Tee, 9 Pos., 600V | FIG 8, Pg 54 | P28574 |



Tee to Tee Adaptor

| Description | See FIG/Page | Part Number |
|---------------------------------|--------------|-------------|
| Male to Female, 9 Pos., 8/14AWG | FIG 9, Pg 55 | P28375 |



9 Position Terminators

| Description | See FIG/Page | Part Number |
|------------------------------|---------------|-------------|
| Single Channel, Male, 9 Pos. | FIG 10, Pg 55 | P27891 |
| Dual Channel, Male, 9 Pos. | FIG 11, Pg 55 | P28573 |



Dimensional Drawings

P28625, Male Straight Plug to Cord Grip, 10AWG, Static, 9 Position

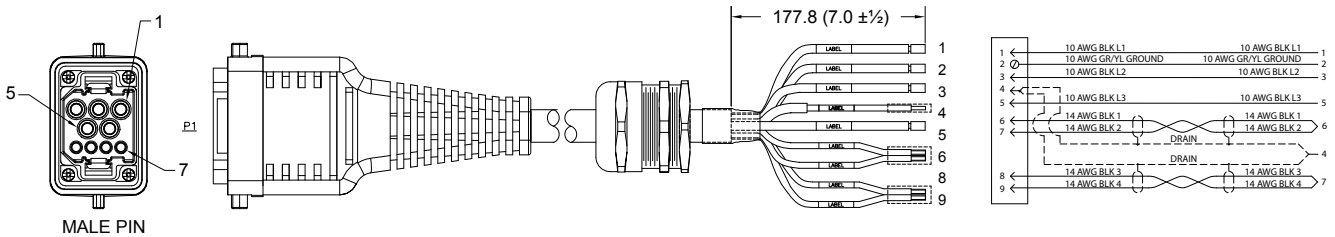

Dimensional Drawings, cont.

FIG 1: Male Straight to Female Straight, Plug, 9 Position

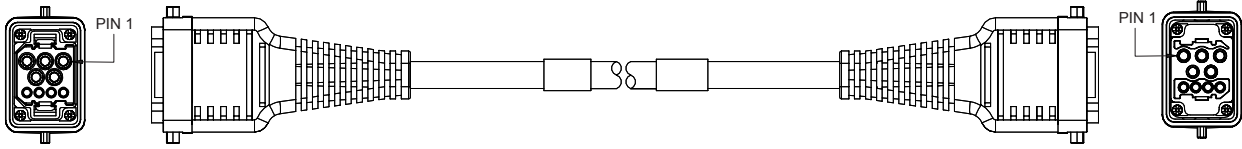

FIG 2: Male 90° to Female Straight, Plug, 9 Position

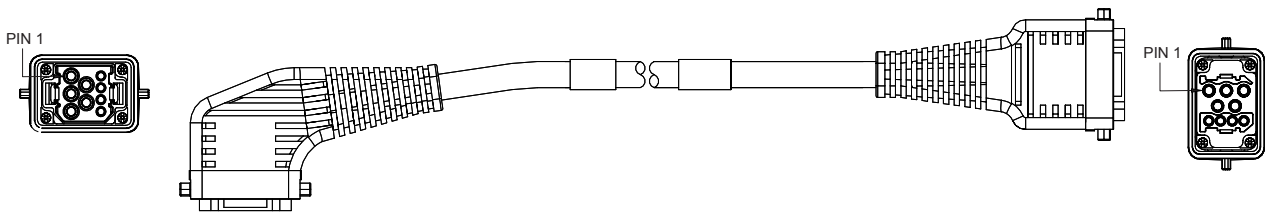

FIG 3: Male Straight to Female 90°, Plug, 9 Position

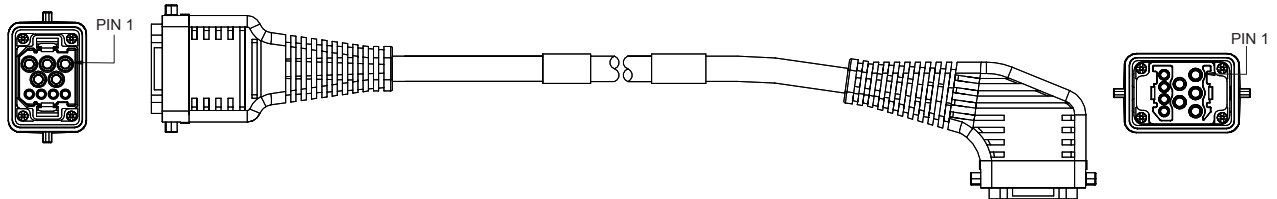

FIG 4: Male 90° to Female 90°, Plug, 9 Position

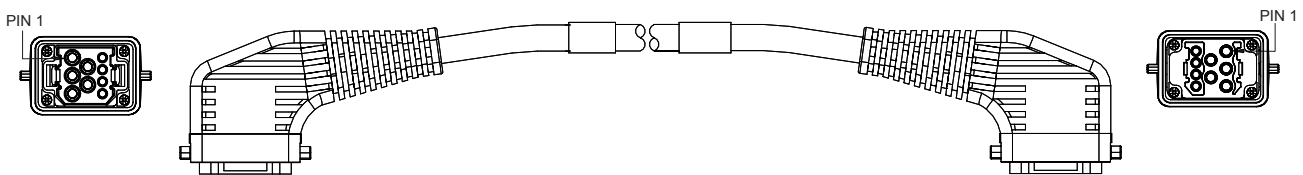

FIG 5: Male Power, Straight, Receptacle

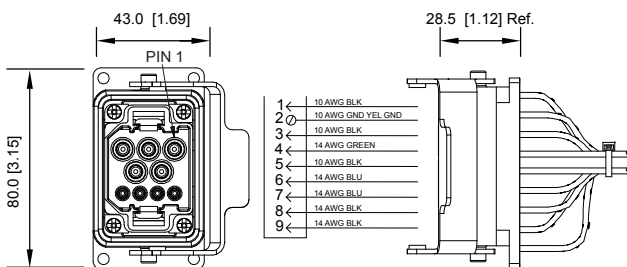
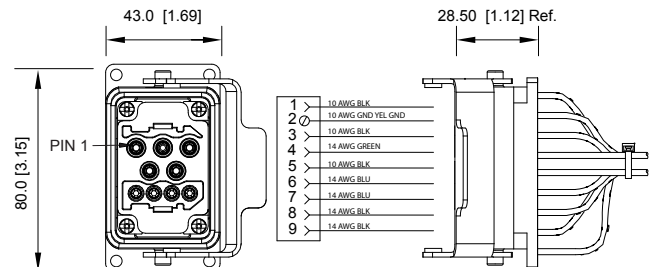

FIG 6: Female Power, Straight, Receptacle



All Dimensions in: mm [inch]

Dimensional Drawings, cont.

FIG 7: Power Tee, 600V, 9 Position

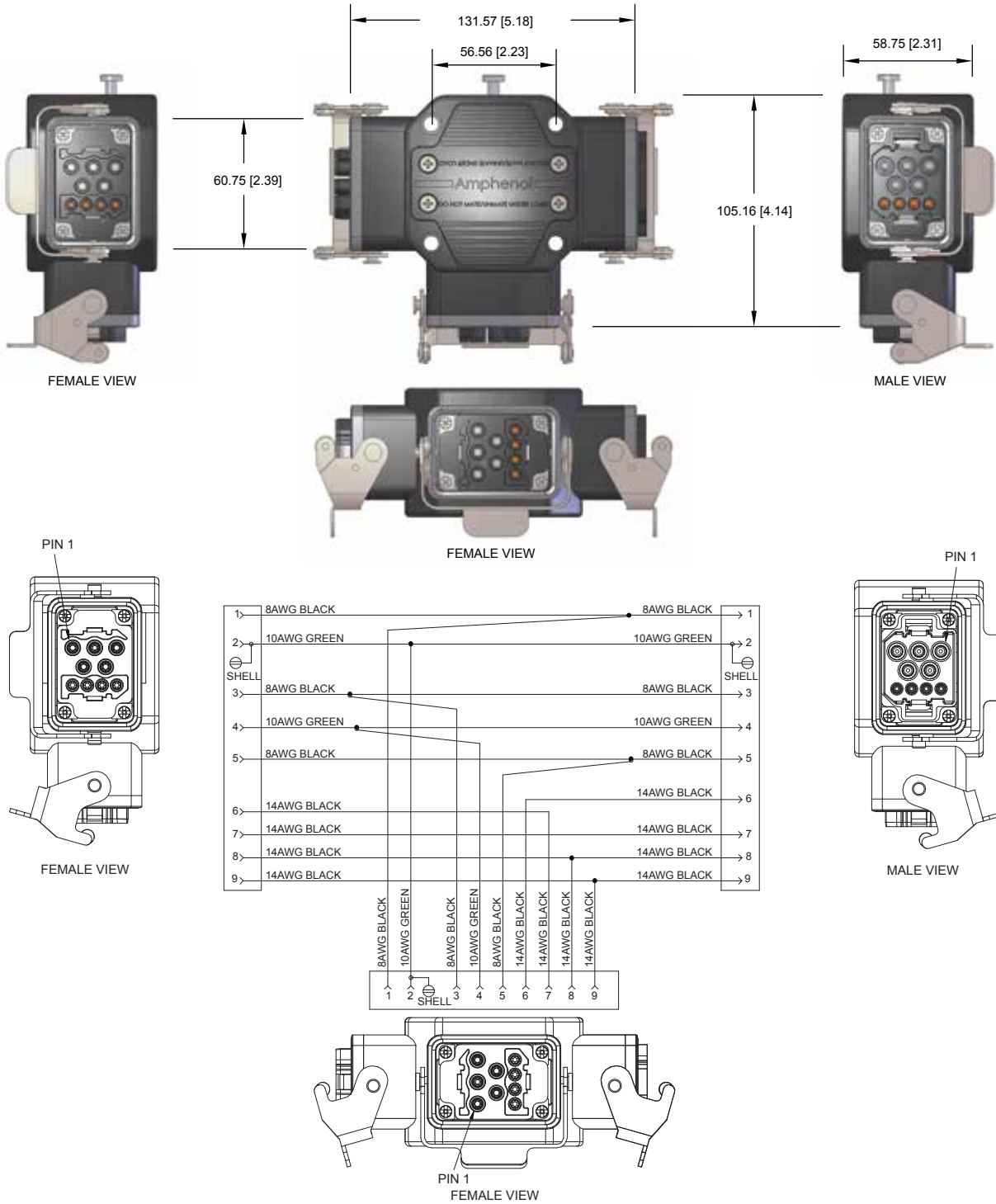

All Dimensions in: mm [inch]

Dimensional Drawings, cont.

FIG 8: Dual Channel Tee, 600V, 9 Position

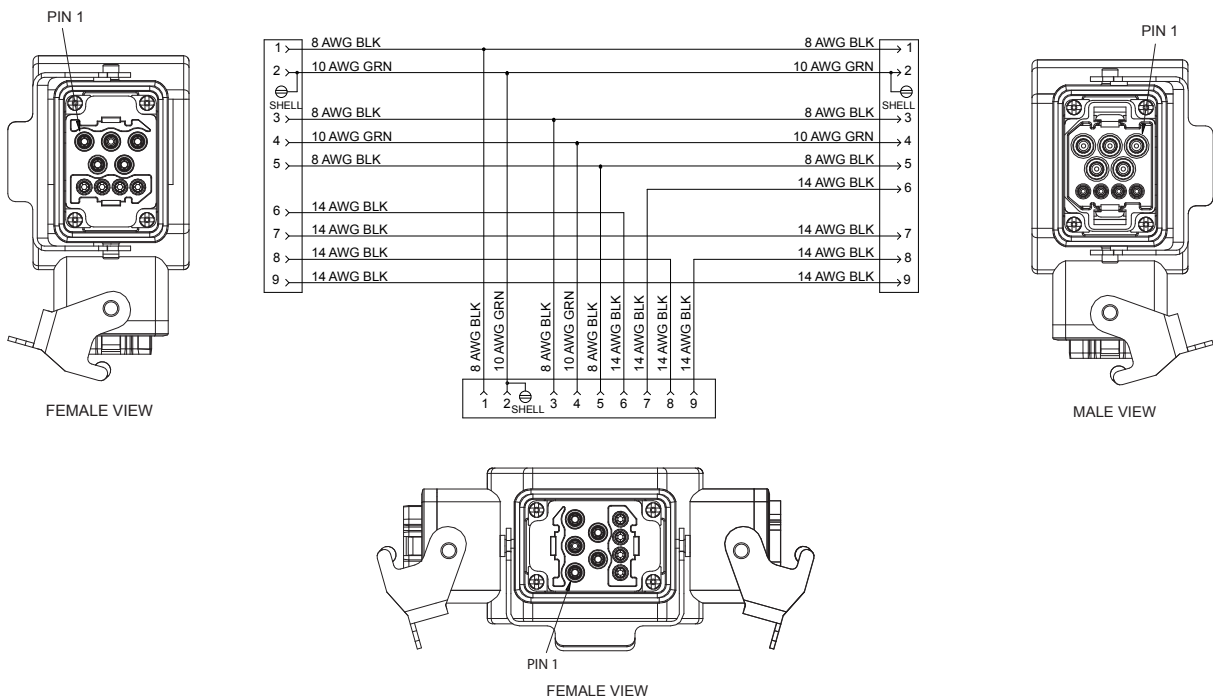
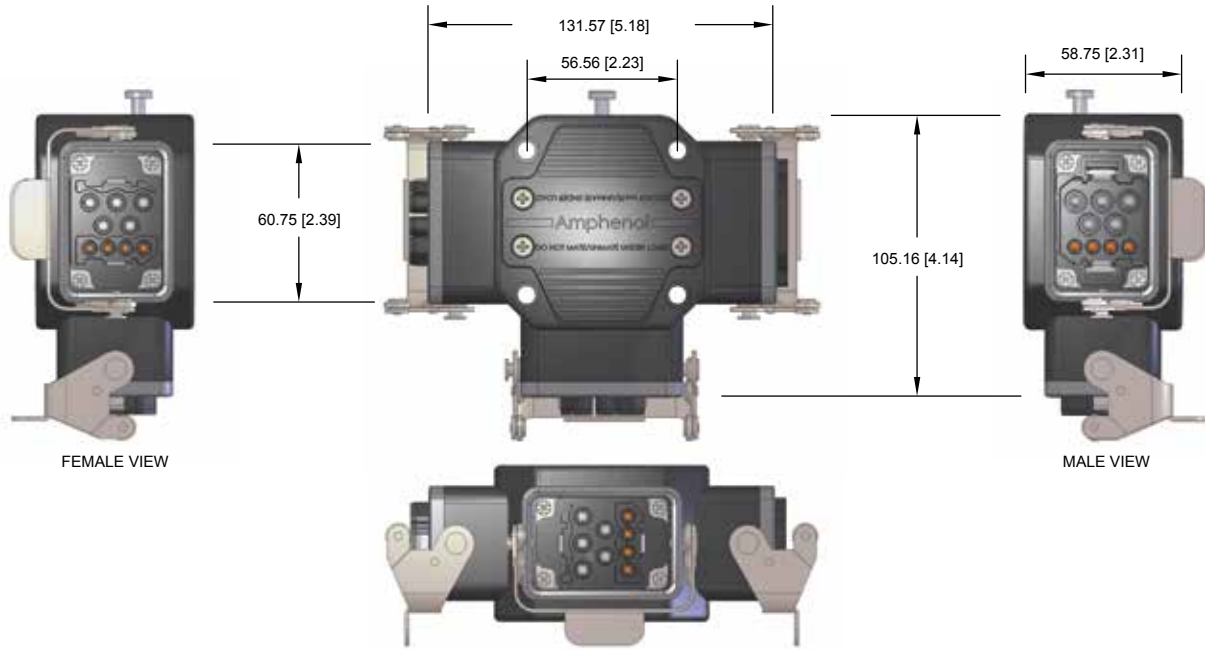

All Dimensions in: mm [inch]

Dimensional Drawings, cont.

FIG 9: Tee to Tee Adaptor, 9 Position

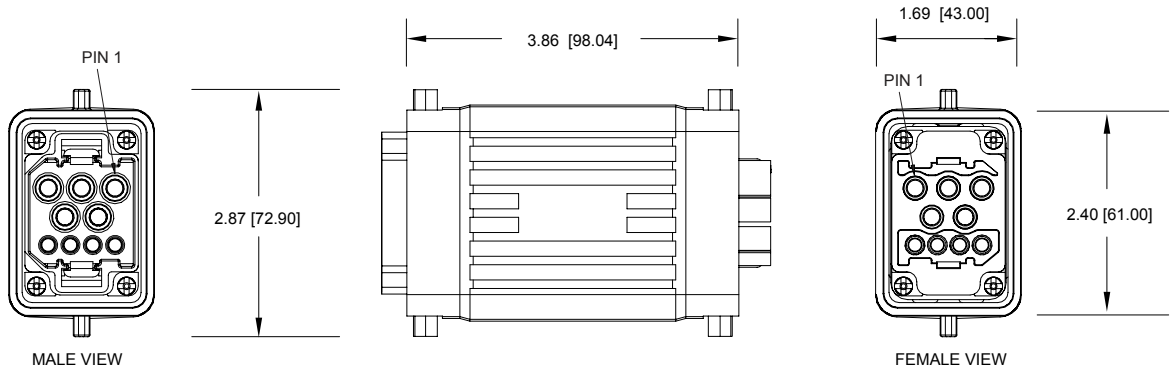

FIG 10: Male, Single Channel, Terminator, 9 Position

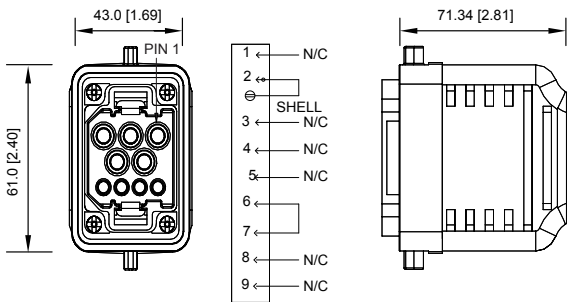
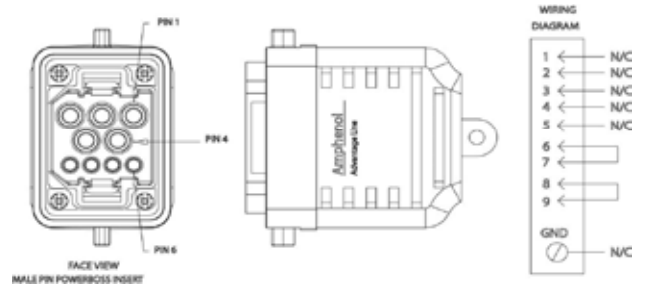
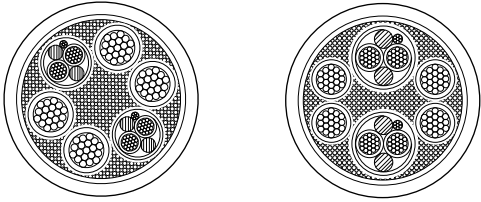
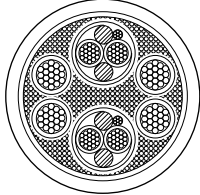

FIG 11: Male, Dual Channel, Terminator, 9 Position



Cable Specifications and Part Numbers

| 8 and 10AWG Static Cable | 10AWG High Flex Cable |
|---|---|
|  |  |

Applications:

- Factory Equipment Interconnects
- Machine Tools
- Control Panels
- Conveyor Systems
- Automotive Assembly Equipment
- Stationary Track/Tray

Specifications:

- UL Type TC-ER (600V)
- CSA AWM II A/B 600V FT4

Characteristics:

- Operating Temperature Range: -25°C to 90°C
- Voltage Rating: 600V
- Conductor: **8 AWG**
 - 4 x 8 AWG
 - 4 x 14 AWG + Shield
- 10 AWG**
 - 4 x 10 AWG
 - 4 x 14 AWG + Shield

Applications:

- High Flexibility/High Bend Applications
- Factory Equipment Interconnects
- Machine Tools
- Flex and Static Track
- Transfer Shuttles

Specifications:

- UL Type TC (600V)
- CSA AWM II A/B 600V FT4

Characteristics:

- Operating Temperature Range: -10°C to 70°C
- Voltage Rating: 1000V
- Conductor: **10 AWG**
 - 4 x 10 AWG
 - 4 x 16 AWG + Shield

| Description | Part Number | *Nominal O.D. | *Minimum Bend Radius |
|--|-------------|---------------|----------------------|
| PowerBOSS™ Power Cable 8AWG | KA-53136 | 0.971 | 6.80 |
| PowerBOSS™ Power Cable 10AWG | KA-56149 | 0.810 | 5.67 |
| PowerBOSS™ Power Cable 10AWG High Flex | KA-56293 | 0.88 | 6.6 |

* Measurements In Inches.

This page intentionally left blank.

ControlBOSS™

Hybrid Power & Communication Network



ControlBOSS™

ControlBOSS™

ControlBOSS™ is the compilation of the industry standard DeviceNet™ and 2 additional circuits. These circuits can be used as additional power to the current DeviceNet™ node power or can be user definable. As an example, the additional circuits could be used to refresh the DeviceNet™ node power or provide additional field input/output power. With this approach, both the DeviceNet™ communication network and additional control can be installed at the same time within one cable thus reducing field installation time and money.

- 600V/15A (Power), 5A (Signal) • 'Plug & Play' Installation • Scalable • Easy to Repeat
- Faster Install & Labor Times • Faster to Market Time • Less Downtime
- Increased Worker Productivity • Elimination of Specialized Tooling
- Reduced Maintenance, Manufacturing and Labor Costs
- Delivers power through buss and drop connectors in 8-12AWG

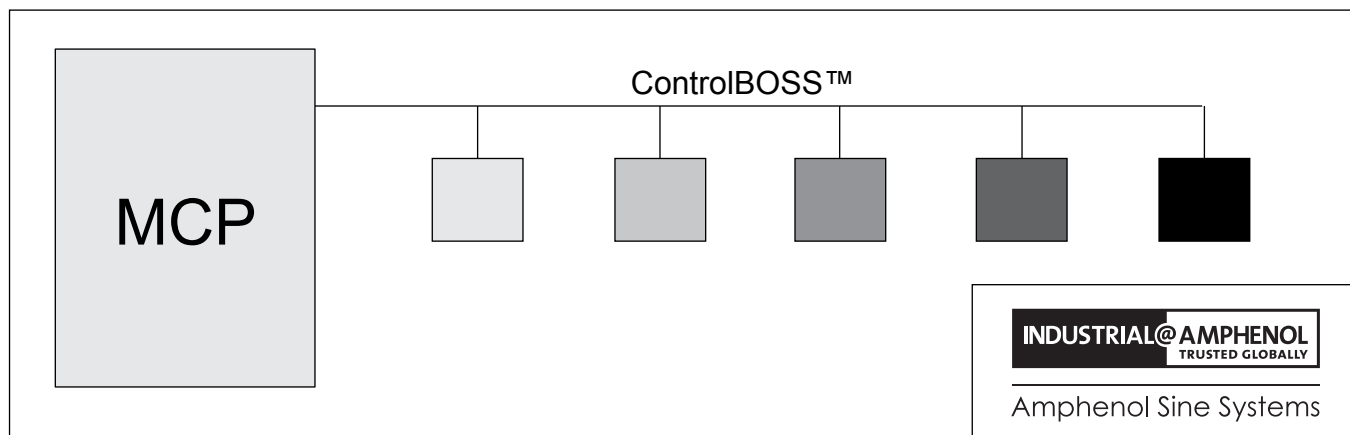
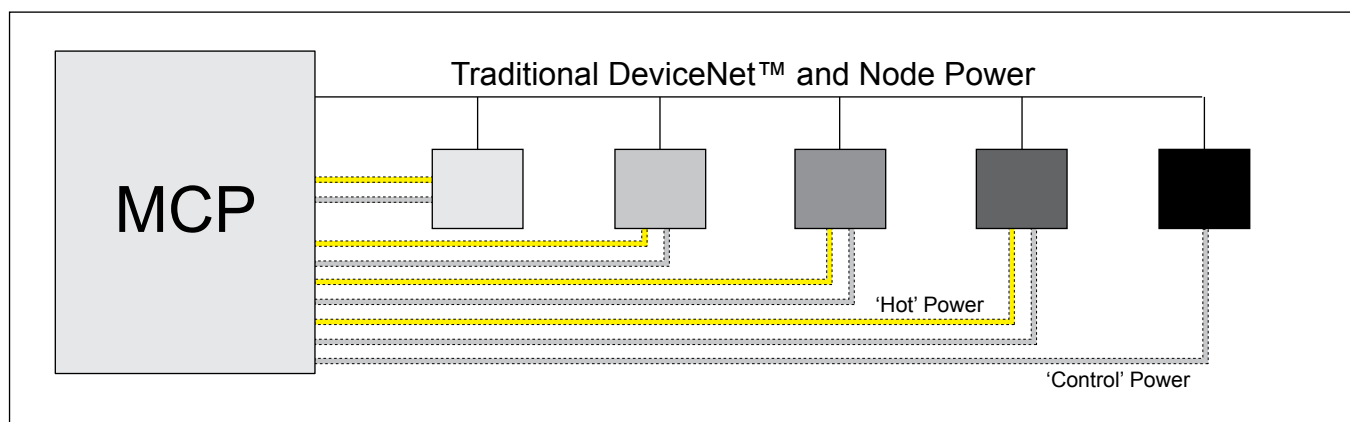

ControlBOSS™ Specifications

| | |
|---|--|
| Two stage over-molded cable assemblies | Strong Thermoplastic contact housing |
| Oil and chemical resistant PVC jacket and molding compounds | UL and CSA listed; UL Type TC-ER |
| IP67 | UL Type TC-ER 600V Class I |
| Uni-Directional cable strain relief | Open wiring rated, compliant to NEC sec. 725.61 (0)(4) and NEC sec. 336.10 |
| Vibration resistant coupling system | Operating temperature – 25°C to 90°C |
| Gold-plated contacts | Unlimited custom length options |
| Heavy duty nickel-plated aluminum die cast shell | |



9 Position Cable Assemblies and Receptacles

Exxx = length in feet
Mxxx = length in meters

| | | 9 Position; 600V; 15A Power, 2A Signal | |
|--------------------|--|--|--|
| Wiring Diagram | | | |
| Number of Contacts | | 6/3 + PE | |
| Cavities 6-9 | | Cavities 6-9 contacts are last mate/first break. Cavity 2 contact is first mate/last mate ground | |

| Static Hybrid Cables | See FIG/Page | 14-18AWG |
|----------------------|--------------|-------------|
| Male Str/Female Str | FIG 1, Pg 62 | P28817-Mxxx |
| Male 90°/Female Str | FIG 2, Pg 62 | P28823-Mxxx |
| Male Str/Female 90° | FIG 3, Pg 62 | P28822-Mxxx |
| Male 90°/Female 90° | FIG 4, Pg 62 | P28818-Mxxx |

| Panel Receptacles | See FIG/Page | 14-18AWG |
|-------------------|--------------|-------------|
| Male Power | FIG 5, Pg 62 | P28819-Mxxx |
| Female Power | FIG 6, Pg 62 | P28816-Mxxx |

Hybrid Tee

| Description | See FIG/Page | Part Number |
|--------------------------|--------------|-------------|
| Hybrid Tee, 9 Pos., 600V | FIG 7, Pg 63 | P28810 |



Tee to Tee Adaptor

| Description | See FIG/Page | Part Number |
|----------------------------------|--------------|-------------|
| Male to Female, 9 Pos., 14/18AWG | FIG 8, Pg 64 | P28825 |



Auxilliary Power Plugs

| Description | See FIG/Page | Part Number - 3 Pos. | See FIG/Page | Part Number - 4 Pos. |
|-------------|---------------|----------------------|---------------|----------------------|
| Male/Female | FIG 10, Pg 64 | P28826 | FIG 12, Pg 65 | P28820 |
| Female/Male | FIG 11, Pg 64 | P28827 | FIG 13, Pg 65 | P28821 |



Terminator Plug

| Description | See FIG/Page | Part Number |
|------------------------|--------------|-------------|
| Terminator, Male, 120V | FIG 9, Pg 64 | P28815 |



Dimensional Drawings

FIG 1: Male Straight to Female Straight, Plug, 9 Position

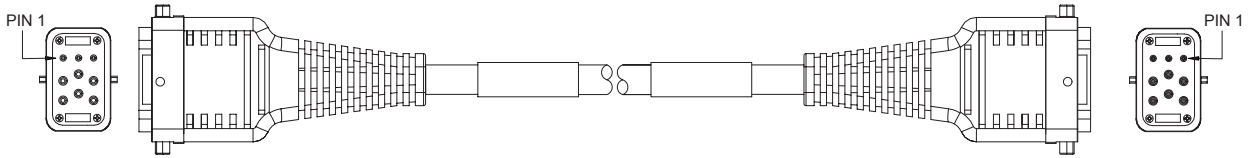

FIG 2: Male 90° to Female Straight, Plug, 9 Position

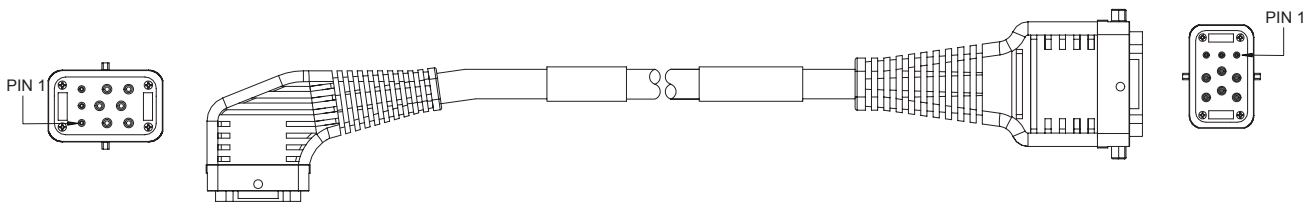

FIG 3: Male Straight to Female 90°, Plug, 9 Position

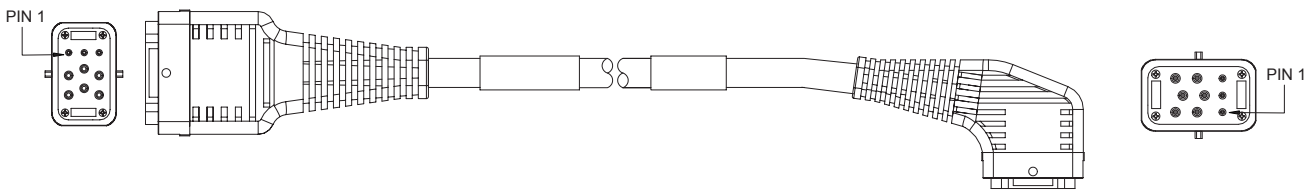

FIG 4: Male 90° to Female 90°, Plug, 9 Position

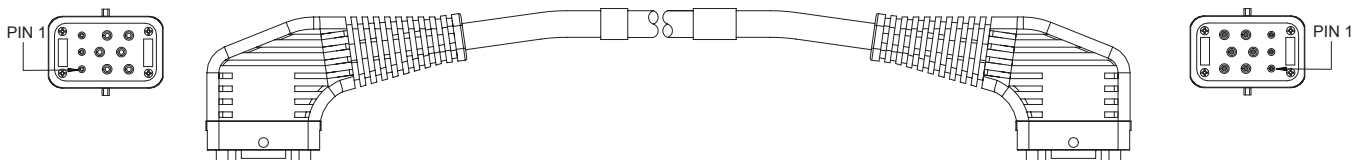

FIG 5: Male Power, Receptacle, Straight, 9 Position

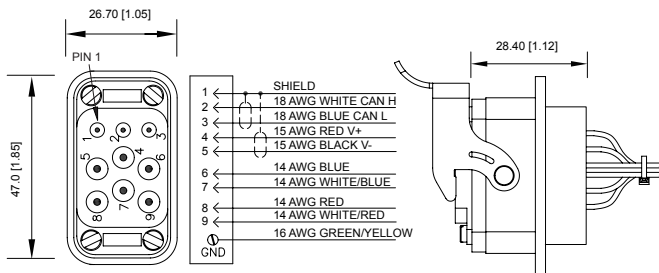
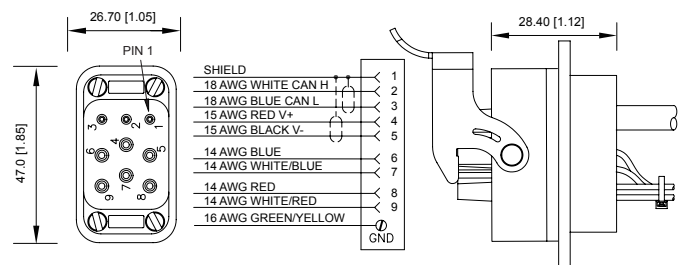

FIG 6: Female Power, Receptacle, Straight, 9 Position



All Dimensions in: mm [inch]

Dimensional Drawings, cont.

FIG 7: Hybrid Tee, 600V, 9 Position

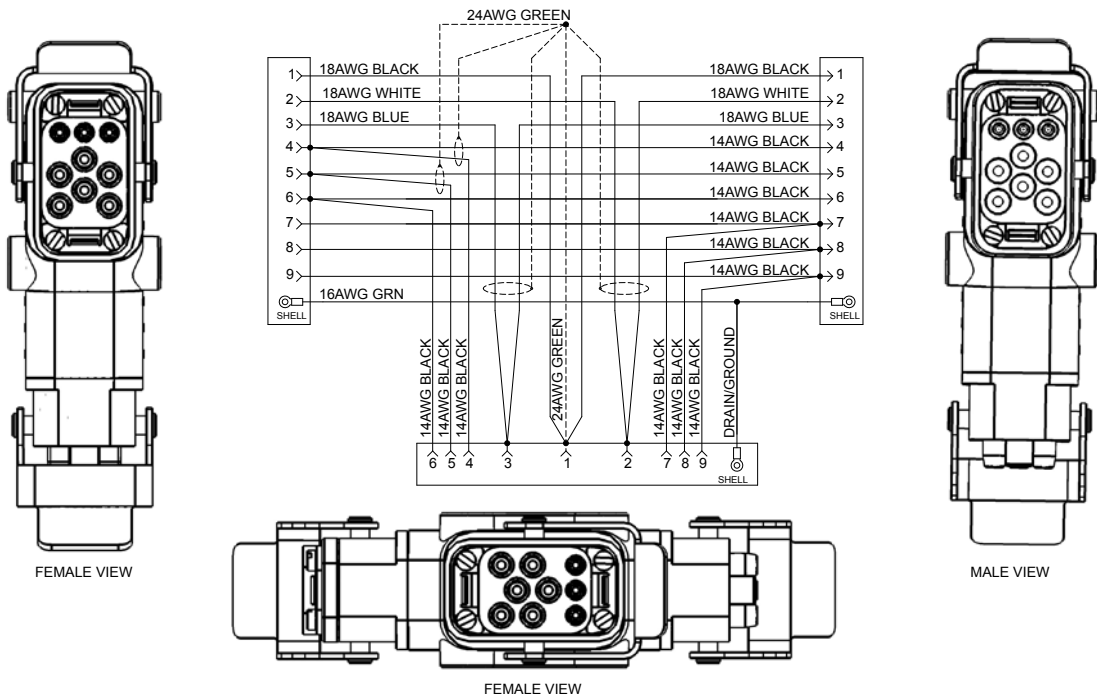
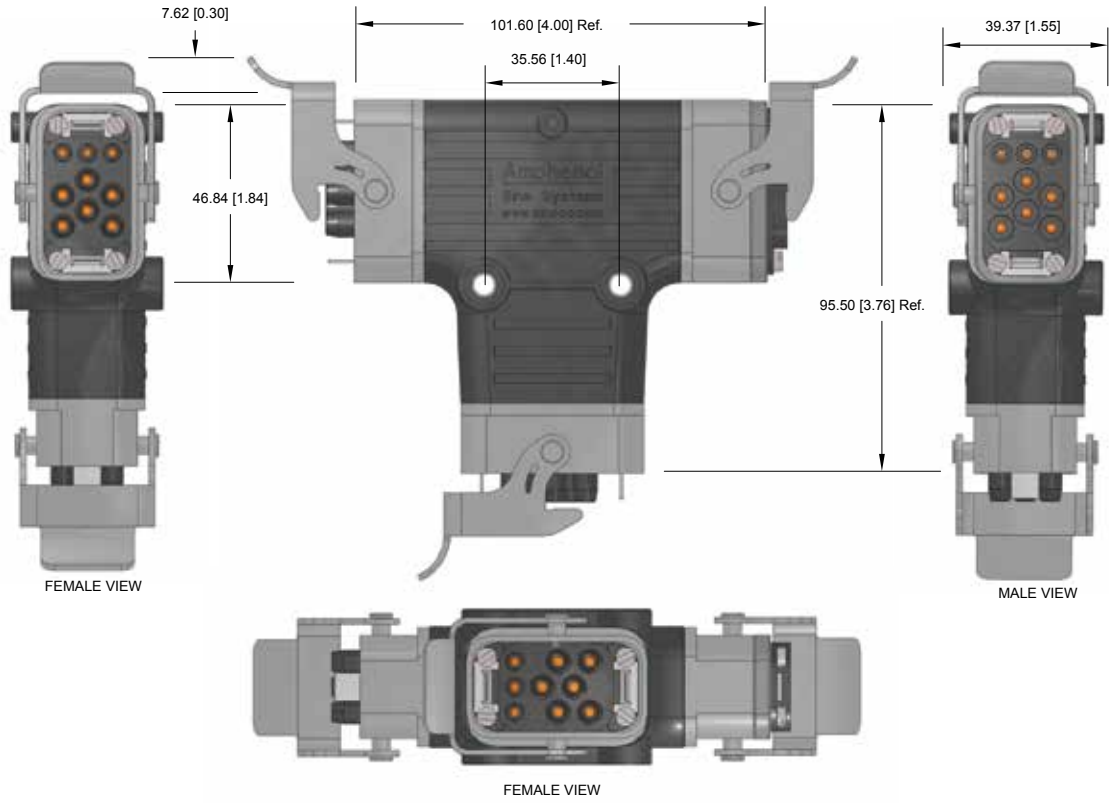

All Dimensions in: mm [inch]

Dimensional Drawings, cont.

FIG 8: Tee to Tee Adaptor, 9 Position

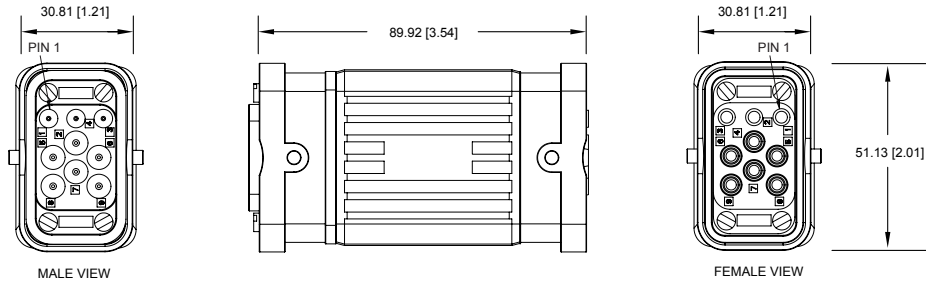

FIG 9: Male, 120V, Terminator, 9 Position

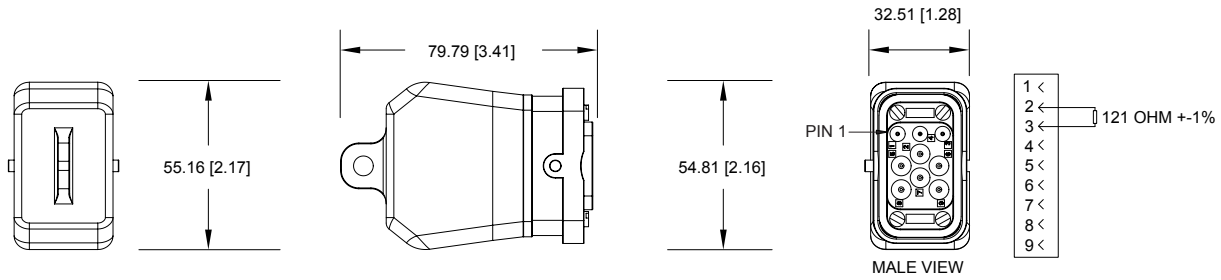

FIG 10: Male to Female, 3 Pin Tap, 9 Position

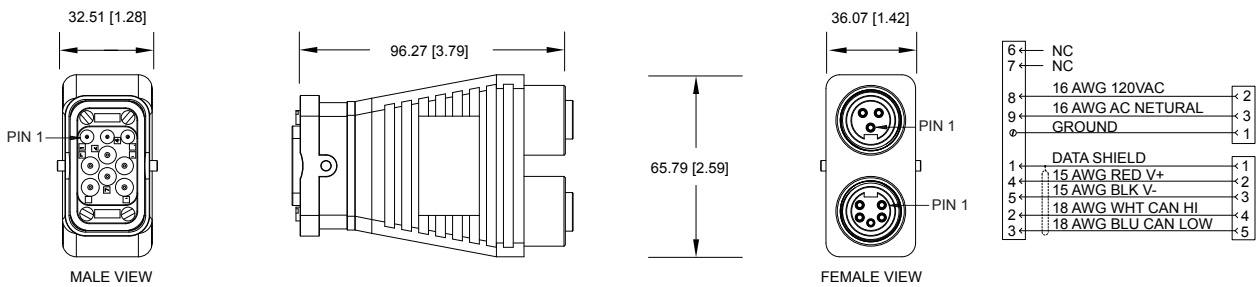
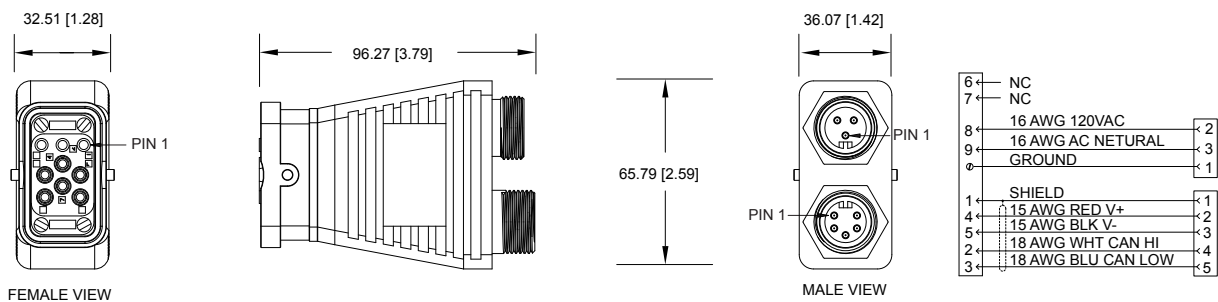

FIG 11: Female to Male, 3 Pin Tap, 9 Position



All Dimensions in: mm [inch]

Dimensional Drawings, cont.

FIG 12: Male to Female, 9 Pos., 4 Pin Tap

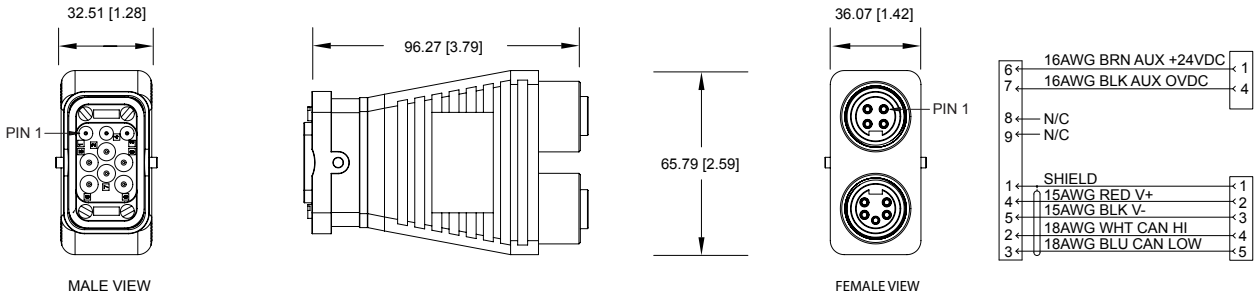
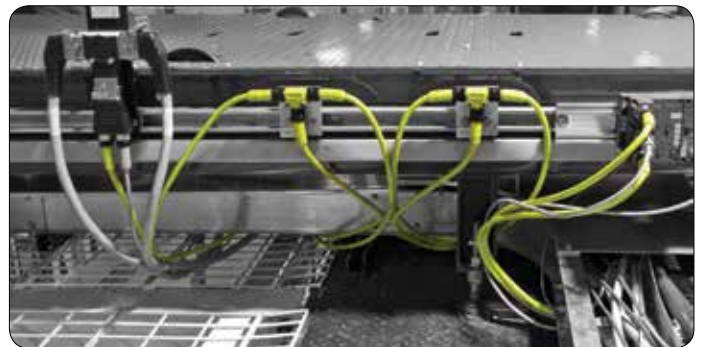
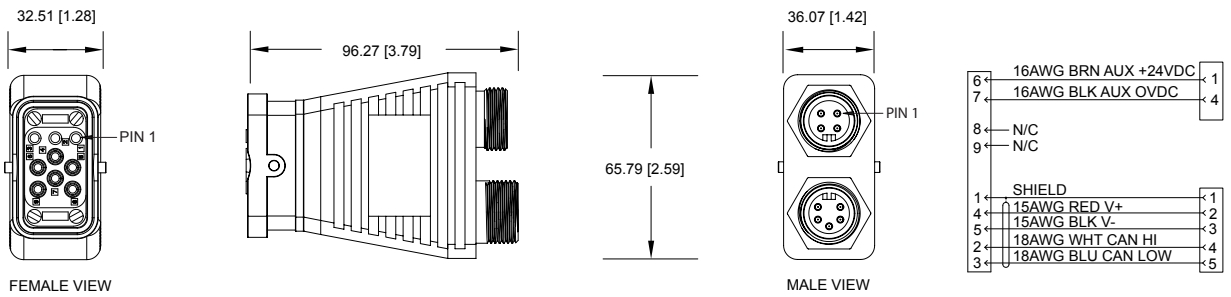

FIG 13: Female to Male, 9 Pos., 4 Pin Tap



All Dimensions in: mm [inch]

Cable Specifications and Part Numbers

Hybrid Cable

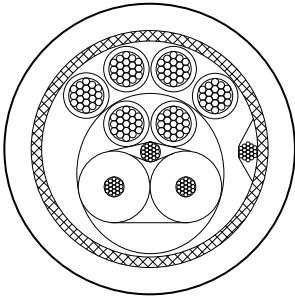

Applications:

- Factory Equipment Interconnects
- Machine Tools
- Control Panels
- Conveyor Systems
- Automotive Assembly Equipment

Characteristics:

- Operating Temperature Range: -25°C to 90°C
- Voltage Rating: 600V
- Conductor: 6 x 14AWG
2 x 18AWG DATA + Shield

Specifications:

- UL Type TC-ER (600V)
- CSA AWM II A/B 600V FT4

| Description | Part Number | *Nominal O.D. | *Minimum Bend Radius |
|---------------------------|-------------|---------------|----------------------|
| ControlBOSS™ Hybrid Cable | KA-56267 | 0.710 | 7.10 |

* Measurements In Inches.



This page intentionally left blank.

VersaBOSS™

Connector & Cable Assemblies



VersaBOSS™

What's in a VersaBOSS™ cable? Let's start with specifically designed VFD cable which maintains outstanding radiated and conductive noise mitigation properties. The "high-strand" conductor construction not only provides greatly enhanced flexibility but also maintains robust shield and ground designs. Industrial grade PVC & TPE jackets combined with an ER rating in a "Turn-Key" system and the motor horsepower tables have now been turned in your favor. Meet VersaBOSS™.

Want more? The VersaBOSS™ has the capacity to exceed the rigors of UL 2237 "short-circuit" Withstand Test and "Distributed Branch Circuit" criteria, an ever increasing requirement from those who demand more from their VFD.

But we didn't stop there. VersaBOSS™ takes your VFD's capabilities to a different level by effectively eliminating the guesswork and subsequent missteps so common in a myriad of electrical cable options available today.



Available in High-Flex/TPE Yellow and Static/PVC Black Cable. Available in Blue, Black or Yellow overmolds.

VersaBOSS™ offers "first of its kind" connector technology in conjunction with advanced cable designs for the multifaceted demands of today's Variable Frequency Drives (VFDs). This factory-terminated and test-certified, sealed and molded cable assembly combines a world-class connector, capable of delivering up to 20A of power in tandem with available signal options in a rapid mating & compact circular design.



Color-coded thermoplastic bands for visual verification.



GuardSafe™ Clip Assemblies to prevent unmating.

- **UL cUL Approved as an Assembly:** Quickly Achieve Standard Compliance Requirements while ensuring Installation safety.
- **Sealed Cable Connections:** Prevents ingress of Dust, liquid & various other contaminants
- **Factory Installed Molded Ends:** No need for field terminations, tools, shield kits or cable gland considerations.
- **Speed of “Plug & Play” Design:** Eliminates “Hard-wiring” & costly skilled labor installation costs while increasing plant flexibility.
- **Factory Conductor Terminations:** Eliminates improper shielding techniques, mis-wires & conductor damage as a result of improper tools. While ensuring thermal stability at connection points.
- **TC “Tray Cable” & ER “Exposed Run”:** Eliminates the need for Conduit, Inter-locked or Armored cable designs.
- **Power & Signal in One:** Optimal designed integrated shielded signal pair & triad options, eliminates multiple cable pulls and mitigates subsequent cable isolation considerations.
- **Superior Performance Shielding:** Effectively control EMI/RFI radiated noise and interference to surrounding electronic devices.
- **High Conductor Stranding:** Increased vibration resistance results in stable electrical performance & flexibility within the cable race way or as exposed cable runs dressed along the structure.
- **Shell to Ground Connector Design:** Inherent features specifically designed for the VFDs grounding requirements ensure low impedance ground path which reduces potential voltage differences & potentially extends service life.
- **Industrial Grade Insulation:** Ensures lower cable capacitance & maximizes power transfer. Higher reliability reduces downtime due to cable failure.
- **Bottom-line Benefits:** System designers & integrators will save time and money through the versatility which is VersaBOSS™. Through faster commissioning and lower installed cost at start-up, residual maintenance savings and your resulting total cost of ownership will result in rapid ROI.



This page intentionally left blank.

FC Hybrid - 9 Position Specifications

| | | | |
|-----------------------|--|------------------------------|----------------------------|
| Housing Body | Zinc Die-cast, Nickel-plated | Insulation Resistance (Min.) | 5000M OHMS |
| Coupling Nut | Aluminum Alloy, Nickel-plated | Dielectric Test Voltage | 2200V |
| Wave Springs | Stainless Steel | Temperature Range | -40°C to 105°C |
| Insulation Insert | Thermoplastic, UL 94/V-0 | Protection | IP67 (Mated Condition) |
| Contacts | Gold Flash-plating over Copper Alloy | Mating Cycles | >500 |
| Seal and O-Rings | NBR (Nitrile Butadiene Rubber) | Vibration Resistance | Per MIL-STD-202 Method 204 |
| Overmold Material | Polyurethane | Thermal Shock | Per MIL-STD-202 Method 207 |
| Cable Jacket Material | High Flex: TPE, Yellow; Static: PVC, Black | 48 Hour Salt Spray | Per MIL-STD-202 Method 101 |



FC Hybrid - 9 Position Cable Assemblies

Mxxx= length in meters

| 9 Position; 600V Power; 30V Signal (Up to 20A Power, 5A Signal); Keying Position - W | |
|--|-------------------------------|
| Wiring Diagram | |
| Number of Contacts | (7) 16AWG, (2) 18AWG |
| Cable Type | High-Flex, TPE, Yellow Jacket |
| | Static, PVC, Black Jacket |
| Male Straight, Single-rated, Blue Overmold <i>(See FIG 1, Pg 75)</i> | <p>P30710-Mxxx</p> |
| | <p>P30712-Mxxx</p> |
| Female Straight, Single-rated, Blue Overmold <i>(See FIG 2, Pg 75)</i> | <p>P30711-Mxxx</p> |
| | <p>P30713-Mxxx</p> |
| Male/Female Straight, Single-rated, Blue Overmold <i>(See FIG 3, Pg 75)</i> | <p>P30538-Mxxx</p> |
| | <p>P30619-Mxxx</p> |

FC Hybrid - 9 Position Receptacles

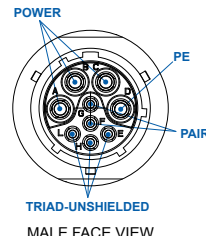
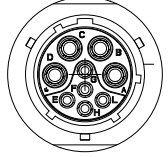
Exxx = length in feet, Hxxx = length in inches

| 9 Position; 600V Power; 30V Signal (Up to 20A Power, 5A Signal); Keying Position - W | | | | | | | | | | | | | | | | | | | | | | | | | | | | | | | | | | | | | | | | | | | | | | | | | | | | | | | | | | | | | | | | | | | | | | | | | |
|--|---|---|-------------|---|---|---|-------------|---|---|---|-------------|---|---|---|---------------|---|---|---|------------|---|---|---|-------------|---|---|---|-----------|---|---|---|-------------|---|---|---|-------------|---|---|---|-------------|---|---|---|-------------|---|---|---|-------------|---|---|---|---------------|---|---|---|------------|---|---|---|-------------|---|---|---|-------------|---|---|---|-------------|---|---|---|-----------|---|---|
| Wiring Diagrams |  <table border="0" style="display: inline-table; vertical-align: top; margin-right: 20px;"> <tr><td>A</td><td>BLACK 16AWG</td><td>↔</td><td>A</td></tr> <tr><td>B</td><td>BLACK 16AWG</td><td>↔</td><td>B</td></tr> <tr><td>C</td><td>BLACK 16AWG</td><td>↔</td><td>C</td></tr> <tr><td>D</td><td>GRN/YEL 16AWG</td><td>↔</td><td>D</td></tr> <tr><td>E</td><td>BLUE 16AWG</td><td>↔</td><td>E</td></tr> <tr><td>H</td><td>WHITE 16AWG</td><td>↔</td><td>H</td></tr> <tr><td>L</td><td>RED 16AWG</td><td>↔</td><td>L</td></tr> <tr><td>G</td><td>BLACK 18AWG</td><td>↔</td><td>G</td></tr> <tr><td>F</td><td>BLACK 18AWG</td><td>↔</td><td>F</td></tr> </table> <table border="0" style="display: inline-table; vertical-align: top;"> <tr><td>A</td><td>BLACK 16AWG</td><td>↔</td><td>A</td></tr> <tr><td>B</td><td>BLACK 16AWG</td><td>↔</td><td>B</td></tr> <tr><td>C</td><td>BLACK 16AWG</td><td>↔</td><td>C</td></tr> <tr><td>D</td><td>GRN/YEL 16AWG</td><td>↔</td><td>D</td></tr> <tr><td>E</td><td>BLUE 16AWG</td><td>↔</td><td>E</td></tr> <tr><td>F</td><td>BLACK 18AWG</td><td>↔</td><td>F</td></tr> <tr><td>G</td><td>BLACK 18AWG</td><td>↔</td><td>G</td></tr> <tr><td>H</td><td>WHITE 16AWG</td><td>↔</td><td>H</td></tr> <tr><td>L</td><td>RED 16AWG</td><td>↔</td><td>L</td></tr> </table>  | A | BLACK 16AWG | ↔ | A | B | BLACK 16AWG | ↔ | B | C | BLACK 16AWG | ↔ | C | D | GRN/YEL 16AWG | ↔ | D | E | BLUE 16AWG | ↔ | E | H | WHITE 16AWG | ↔ | H | L | RED 16AWG | ↔ | L | G | BLACK 18AWG | ↔ | G | F | BLACK 18AWG | ↔ | F | A | BLACK 16AWG | ↔ | A | B | BLACK 16AWG | ↔ | B | C | BLACK 16AWG | ↔ | C | D | GRN/YEL 16AWG | ↔ | D | E | BLUE 16AWG | ↔ | E | F | BLACK 18AWG | ↔ | F | G | BLACK 18AWG | ↔ | G | H | WHITE 16AWG | ↔ | H | L | RED 16AWG | ↔ | L |
| A | BLACK 16AWG | ↔ | A | | | | | | | | | | | | | | | | | | | | | | | | | | | | | | | | | | | | | | | | | | | | | | | | | | | | | | | | | | | | | | | | | | | | | | |
| B | BLACK 16AWG | ↔ | B | | | | | | | | | | | | | | | | | | | | | | | | | | | | | | | | | | | | | | | | | | | | | | | | | | | | | | | | | | | | | | | | | | | | | | |
| C | BLACK 16AWG | ↔ | C | | | | | | | | | | | | | | | | | | | | | | | | | | | | | | | | | | | | | | | | | | | | | | | | | | | | | | | | | | | | | | | | | | | | | | |
| D | GRN/YEL 16AWG | ↔ | D | | | | | | | | | | | | | | | | | | | | | | | | | | | | | | | | | | | | | | | | | | | | | | | | | | | | | | | | | | | | | | | | | | | | | | |
| E | BLUE 16AWG | ↔ | E | | | | | | | | | | | | | | | | | | | | | | | | | | | | | | | | | | | | | | | | | | | | | | | | | | | | | | | | | | | | | | | | | | | | | | |
| H | WHITE 16AWG | ↔ | H | | | | | | | | | | | | | | | | | | | | | | | | | | | | | | | | | | | | | | | | | | | | | | | | | | | | | | | | | | | | | | | | | | | | | | |
| L | RED 16AWG | ↔ | L | | | | | | | | | | | | | | | | | | | | | | | | | | | | | | | | | | | | | | | | | | | | | | | | | | | | | | | | | | | | | | | | | | | | | | |
| G | BLACK 18AWG | ↔ | G | | | | | | | | | | | | | | | | | | | | | | | | | | | | | | | | | | | | | | | | | | | | | | | | | | | | | | | | | | | | | | | | | | | | | | |
| F | BLACK 18AWG | ↔ | F | | | | | | | | | | | | | | | | | | | | | | | | | | | | | | | | | | | | | | | | | | | | | | | | | | | | | | | | | | | | | | | | | | | | | | |
| A | BLACK 16AWG | ↔ | A | | | | | | | | | | | | | | | | | | | | | | | | | | | | | | | | | | | | | | | | | | | | | | | | | | | | | | | | | | | | | | | | | | | | | | |
| B | BLACK 16AWG | ↔ | B | | | | | | | | | | | | | | | | | | | | | | | | | | | | | | | | | | | | | | | | | | | | | | | | | | | | | | | | | | | | | | | | | | | | | | |
| C | BLACK 16AWG | ↔ | C | | | | | | | | | | | | | | | | | | | | | | | | | | | | | | | | | | | | | | | | | | | | | | | | | | | | | | | | | | | | | | | | | | | | | | |
| D | GRN/YEL 16AWG | ↔ | D | | | | | | | | | | | | | | | | | | | | | | | | | | | | | | | | | | | | | | | | | | | | | | | | | | | | | | | | | | | | | | | | | | | | | | |
| E | BLUE 16AWG | ↔ | E | | | | | | | | | | | | | | | | | | | | | | | | | | | | | | | | | | | | | | | | | | | | | | | | | | | | | | | | | | | | | | | | | | | | | | |
| F | BLACK 18AWG | ↔ | F | | | | | | | | | | | | | | | | | | | | | | | | | | | | | | | | | | | | | | | | | | | | | | | | | | | | | | | | | | | | | | | | | | | | | | |
| G | BLACK 18AWG | ↔ | G | | | | | | | | | | | | | | | | | | | | | | | | | | | | | | | | | | | | | | | | | | | | | | | | | | | | | | | | | | | | | | | | | | | | | | |
| H | WHITE 16AWG | ↔ | H | | | | | | | | | | | | | | | | | | | | | | | | | | | | | | | | | | | | | | | | | | | | | | | | | | | | | | | | | | | | | | | | | | | | | | |
| L | RED 16AWG | ↔ | L | | | | | | | | | | | | | | | | | | | | | | | | | | | | | | | | | | | | | | | | | | | | | | | | | | | | | | | | | | | | | | | | | | | | | | |
| Number of Contacts | (7) 16AWG, (2) 18AWG | | | | | | | | | | | | | | | | | | | | | | | | | | | | | | | | | | | | | | | | | | | | | | | | | | | | | | | | | | | | | | | | | | | | | | | | |
| Type | Male Female | | | | | | | | | | | | | | | | | | | | | | | | | | | | | | | | | | | | | | | | | | | | | | | | | | | | | | | | | | | | | | | | | | | | | | | | |
| Blue Color Band <i>(See FIG 4 and 5, Pg 76)</i> |   | | | | | | | | | | | | | | | | | | | | | | | | | | | | | | | | | | | | | | | | | | | | | | | | | | | | | | | | | | | | | | | | | | | | | | | | |
| | P30540- (Select either -Exxx or -Hxxx) P30539- (Select either -Exxx or -Hxxx) | | | | | | | | | | | | | | | | | | | | | | | | | | | | | | | | | | | | | | | | | | | | | | | | | | | | | | | | | | | | | | | | | | | | | | | | |

Dimensional Drawings

FIG 1: Male, Plug, Straight, 9 Position

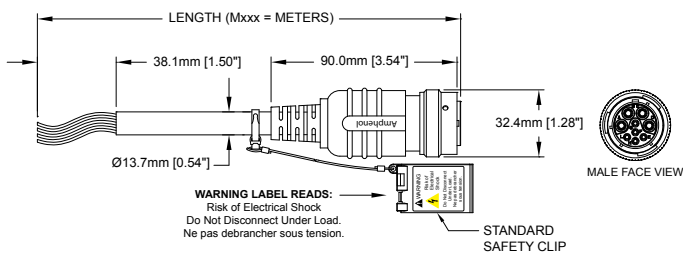

FIG 2: Female, Plug, Straight, 9 Position

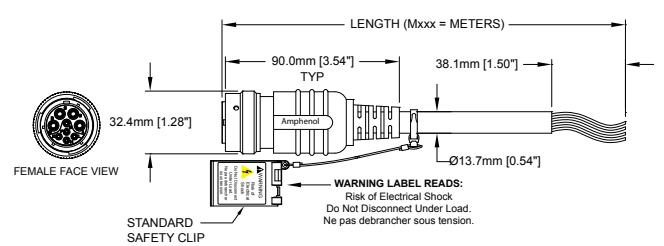
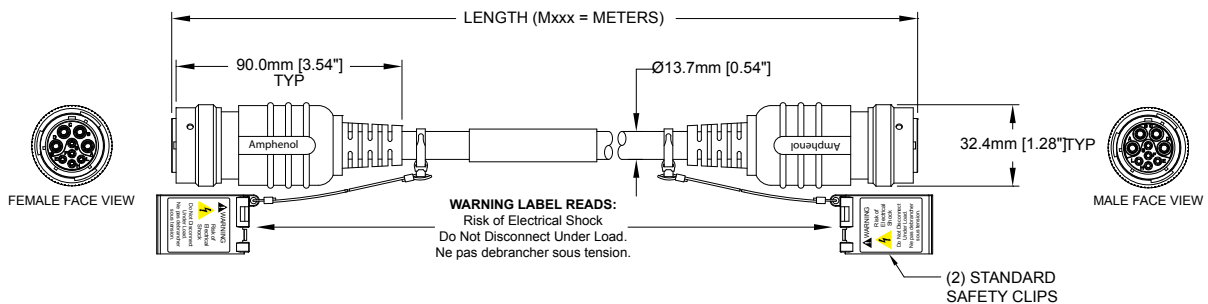

FIG 3: Male to Female, Plug, Straight, 9 Position



All Dimensions in: mm [inch]

Dimensional Drawings, cont.

FIG 4: Male, Receptacle, Straight, 9 Position

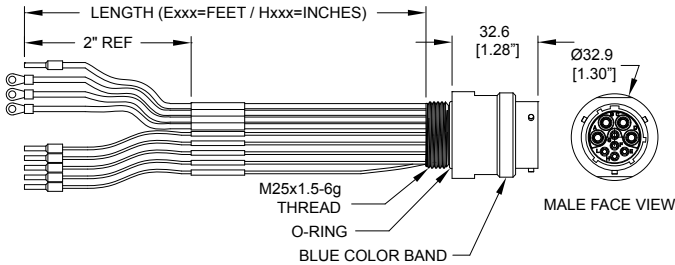
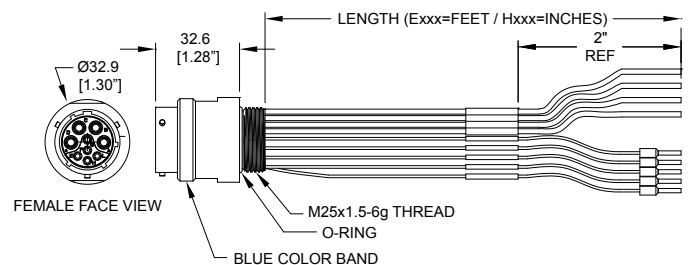
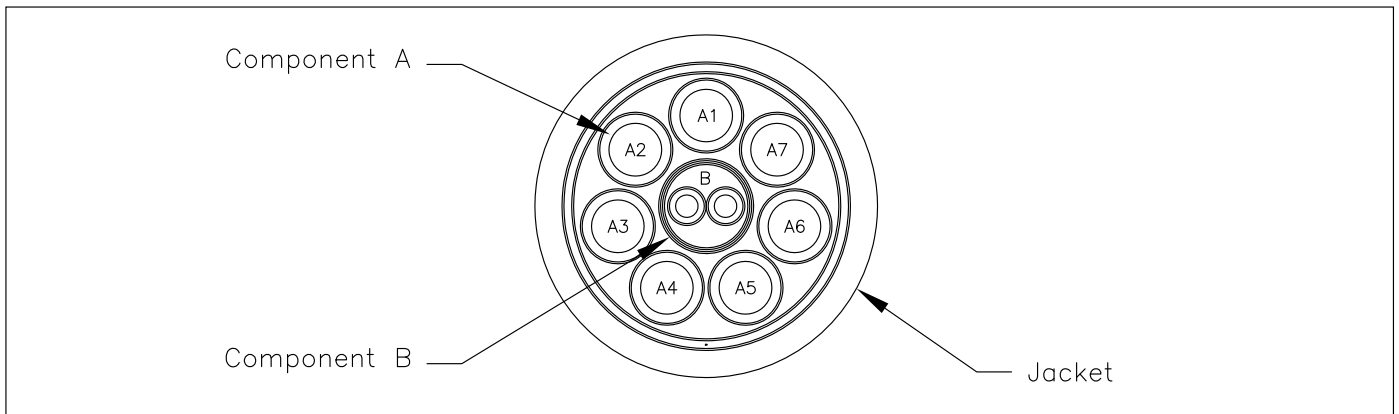

FIG 5: Female, Receptacle, Straight, 9 Position



All Dimensions in: mm [inch]



1.0 Component A – 16 AWG

16 AWG: Bare Copper
Insulation: PVC
Jacket: Clear Nylon

2.0 Component B – Shielded Pair – 18 AWG

18 AWG: Bare Copper
Insulation: PVC
Jacket: Clear Nylon
Pair: (2) Conductors Cabled Together
Binder: PTFE Tape
Shield: Tinned Copper Braided Shield, 90% Coverage
Separator: PTFE Tape

3.0 Construction

Core: (1) Component B
Layer 1: (7) Component A and Fillers as required for roundness.
Binder: PTFE Tape
Shield: Tinned Copper Braided Shield, 90% Coverage
Binder: PTFE Tape
Jacket: TPE, Color: Yellow
Diameter: .520" Nominal

4.0 Print Legend

AMPHENOL SINE SYSTEMS KA-56639 (UL File #)
7/C 16 AWG + 1/PR 18 AWG (UL) TYPE TC-ER
90C DRY 75C WET 600V SUN RES DIR BUR ---
(CSA FILE #) CSA AWM I/II A/B 90C 600V FT4

COLOR CODE

| Component | COLOR |
|-----------|------------------------|
| A1 | Black and printed "U1" |
| A2 | Black and printed "V1" |
| A3 | Black and printed "W1" |
| A4 | Green/Yellow |
| A5 | Blue and printed "15" |
| A6 | White and printed "14" |
| A7 | Red and printed "13" |
| B1 | Black printed "TH1" |
| B2 | Black printed "TH2" |

5.0 Physical & Electrical Characteristics

Temperature Rating: 90°C
Voltage Rating: 600V

Design Intended to Meet:

10M cycles @ 10x O.D.
Torsional – 100K cycles ±180° @ 1 Meter

6.0 Standards

UL: TYPE TC-ER
CSA: AWM I/II A/B FT4
RoHS COMPLIANT

VersaBOSS™ FC
Cable Specifications



Amphenol Sine Systems

This page intentionally left blank.

MC - 9 Position Specifications

| | | | |
|-----------------------|--|------------------------------|----------------------------|
| Housing Body | Zinc Die-cast, Nickel-plated | Insulation Resistance (Min.) | 5000M OHMS |
| Coupling Nut | Aluminum Alloy, Nickel-plated | Dielectric Test Voltage | 2200V |
| Wave Springs | Stainless Steel | Temperature Range | -40°C to 105°C |
| Insulation Insert | Thermoplastic, UL 94/V-0 | Protection | IP67 (Mated Condition) |
| Contacts | Gold Flash-plating over Copper Alloy | Mating Cycles | >500 |
| Seal and O-Rings | NBR (Nitrile Butadiene Rubber) | Vibration Resistance | Per MIL-STD-202 Method 204 |
| Overmold Material | Polyurethane | Thermal Shock | Per MIL-STD-202 Method 207 |
| Cable Jacket Material | High Flex: TPE, Yellow; Static: PVC, Black | 48 Hour Salt Spray | Per MIL-STD-202 Method 101 |



MC - 9 Position Cable Assemblies

Mxxx = length in meters

| 9 Position; 600V Power; 30V Signal (Up to 20A Power, 5A Signal); Keying Position - N | | |
|--|-------------------------------|---------------------------|
| Wiring Diagram | | |
| Number of Contacts | (4) 13AWG, (5) 18AWG | |
| Cable Type | High-Flex, TPE, Yellow Jacket | Static, PVC, Black Jacket |
| Male Straight, Single-rated, Black Overmold <i>(See FIG 1, Pg 79)</i> | P30552-Mxxx | P30664-Mxxx |
| Female Straight, Single-rated, Black Overmold <i>(See FIG 2, Pg 79)</i> | P30553-Mxxx | P30665-Mxxx |
| Male/Female Straight, Single-rated, Black Overmold <i>(See FIG 3, Pg 79)</i> | P30165-Mxxx | P30648-Mxxx |

MC - 9 Position Receptacles

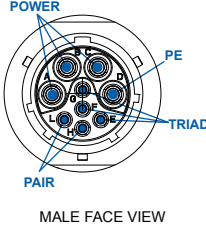
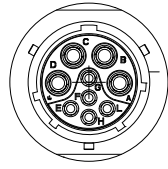
Exxx = length in feet, Hxxx = length in inches

| 9 Position; 600V Power; 30V Signal (Up to 20A Power, 5A Signal); Keying Position - N | | | | | | | | | | | | | | | | | | | | | | | | | | | | | | | | | | | | | | | | | | | | | | | | | | | | | | | |
|--|--|---|-------------|---|---|-------------|---|---|-------------|---|---|--------------------|---|---|-------------|---|---|--------------|---|---|-------------|---|---|-----------|---|---|-------------|---|---|-------------|---|---|-------------|---|---|-------------|---|---|--------------------|---|---|-------------|---|---|--------------|---|---|-------------|---|---|-----------|---|---|-------------|---|
| Male Face View |  <table border="0" style="display: inline-table; vertical-align: top;"> <tr><td>A</td><td>BLACK 14AWG</td><td>A</td></tr> <tr><td>B</td><td>BLACK 14AWG</td><td>B</td></tr> <tr><td>C</td><td>BLACK 14AWG</td><td>C</td></tr> <tr><td>D</td><td>GREEN/YELLOW 14AWG</td><td>D</td></tr> <tr><td>E</td><td>GREEN 18AWG</td><td>E</td></tr> <tr><td>F</td><td>ORANGE 18AWG</td><td>F</td></tr> <tr><td>G</td><td>WHITE 18AWG</td><td>G</td></tr> <tr><td>H</td><td>RED 18AWG</td><td>H</td></tr> <tr><td>L</td><td>WHITE 18AWG</td><td>L</td></tr> </table> <table border="0" style="display: inline-table; vertical-align: top; margin-left: 20px;"> <tr><td>A</td><td>BLACK 14AWG</td><td>A</td></tr> <tr><td>B</td><td>BLACK 14AWG</td><td>B</td></tr> <tr><td>C</td><td>BLACK 14AWG</td><td>C</td></tr> <tr><td>D</td><td>GREEN/YELLOW 14AWG</td><td>D</td></tr> <tr><td>E</td><td>GREEN 18AWG</td><td>E</td></tr> <tr><td>F</td><td>ORANGE 18AWG</td><td>F</td></tr> <tr><td>G</td><td>WHITE 18AWG</td><td>G</td></tr> <tr><td>H</td><td>RED 18AWG</td><td>H</td></tr> <tr><td>L</td><td>WHITE 18AWG</td><td>L</td></tr> </table>  | A | BLACK 14AWG | A | B | BLACK 14AWG | B | C | BLACK 14AWG | C | D | GREEN/YELLOW 14AWG | D | E | GREEN 18AWG | E | F | ORANGE 18AWG | F | G | WHITE 18AWG | G | H | RED 18AWG | H | L | WHITE 18AWG | L | A | BLACK 14AWG | A | B | BLACK 14AWG | B | C | BLACK 14AWG | C | D | GREEN/YELLOW 14AWG | D | E | GREEN 18AWG | E | F | ORANGE 18AWG | F | G | WHITE 18AWG | G | H | RED 18AWG | H | L | WHITE 18AWG | L |
| A | BLACK 14AWG | A | | | | | | | | | | | | | | | | | | | | | | | | | | | | | | | | | | | | | | | | | | | | | | | | | | | | | |
| B | BLACK 14AWG | B | | | | | | | | | | | | | | | | | | | | | | | | | | | | | | | | | | | | | | | | | | | | | | | | | | | | | |
| C | BLACK 14AWG | C | | | | | | | | | | | | | | | | | | | | | | | | | | | | | | | | | | | | | | | | | | | | | | | | | | | | | |
| D | GREEN/YELLOW 14AWG | D | | | | | | | | | | | | | | | | | | | | | | | | | | | | | | | | | | | | | | | | | | | | | | | | | | | | | |
| E | GREEN 18AWG | E | | | | | | | | | | | | | | | | | | | | | | | | | | | | | | | | | | | | | | | | | | | | | | | | | | | | | |
| F | ORANGE 18AWG | F | | | | | | | | | | | | | | | | | | | | | | | | | | | | | | | | | | | | | | | | | | | | | | | | | | | | | |
| G | WHITE 18AWG | G | | | | | | | | | | | | | | | | | | | | | | | | | | | | | | | | | | | | | | | | | | | | | | | | | | | | | |
| H | RED 18AWG | H | | | | | | | | | | | | | | | | | | | | | | | | | | | | | | | | | | | | | | | | | | | | | | | | | | | | | |
| L | WHITE 18AWG | L | | | | | | | | | | | | | | | | | | | | | | | | | | | | | | | | | | | | | | | | | | | | | | | | | | | | | |
| A | BLACK 14AWG | A | | | | | | | | | | | | | | | | | | | | | | | | | | | | | | | | | | | | | | | | | | | | | | | | | | | | | |
| B | BLACK 14AWG | B | | | | | | | | | | | | | | | | | | | | | | | | | | | | | | | | | | | | | | | | | | | | | | | | | | | | | |
| C | BLACK 14AWG | C | | | | | | | | | | | | | | | | | | | | | | | | | | | | | | | | | | | | | | | | | | | | | | | | | | | | | |
| D | GREEN/YELLOW 14AWG | D | | | | | | | | | | | | | | | | | | | | | | | | | | | | | | | | | | | | | | | | | | | | | | | | | | | | | |
| E | GREEN 18AWG | E | | | | | | | | | | | | | | | | | | | | | | | | | | | | | | | | | | | | | | | | | | | | | | | | | | | | | |
| F | ORANGE 18AWG | F | | | | | | | | | | | | | | | | | | | | | | | | | | | | | | | | | | | | | | | | | | | | | | | | | | | | | |
| G | WHITE 18AWG | G | | | | | | | | | | | | | | | | | | | | | | | | | | | | | | | | | | | | | | | | | | | | | | | | | | | | | |
| H | RED 18AWG | H | | | | | | | | | | | | | | | | | | | | | | | | | | | | | | | | | | | | | | | | | | | | | | | | | | | | | |
| L | WHITE 18AWG | L | | | | | | | | | | | | | | | | | | | | | | | | | | | | | | | | | | | | | | | | | | | | | | | | | | | | | |
| Number of Contacts | (4) 13AWG, (5) 18AWG | | | | | | | | | | | | | | | | | | | | | | | | | | | | | | | | | | | | | | | | | | | | | | | | | | | | | | |
| Type | Male | | | | | | | | | | | | | | | | | | | | | | | | | | | | | | | | | | | | | | | | | | | | | | | | | | | | | | |
| Black Color Band <i>(See FIG 4 and 5, Pg 80)</i> |  <p>P30167- (Select either Exxx or Hxxx)</p> | | | | | | | | | | | | | | | | | | | | | | | | | | | | | | | | | | | | | | | | | | | | | | | | | | | | | | |
| | Female | | | | | | | | | | | | | | | | | | | | | | | | | | | | | | | | | | | | | | | | | | | | | | | | | | | | | | |
| |  <p>P30166- (Select either Exxx or Hxxx)</p> | | | | | | | | | | | | | | | | | | | | | | | | | | | | | | | | | | | | | | | | | | | | | | | | | | | | | | |

Dimensional Drawings

FIG 1: Male, Plug, Straight, 9 Position

FIG 2: Female, Plug, Straight, 9 Position

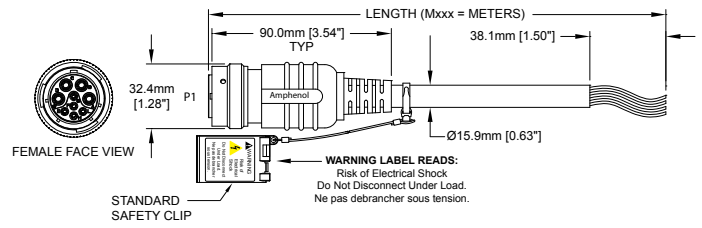
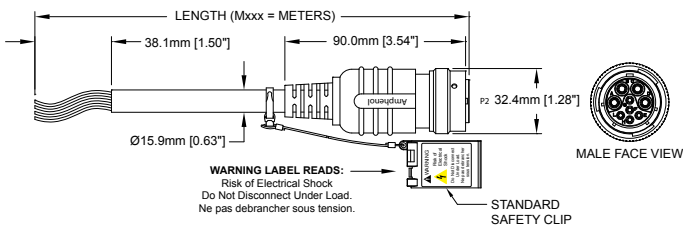
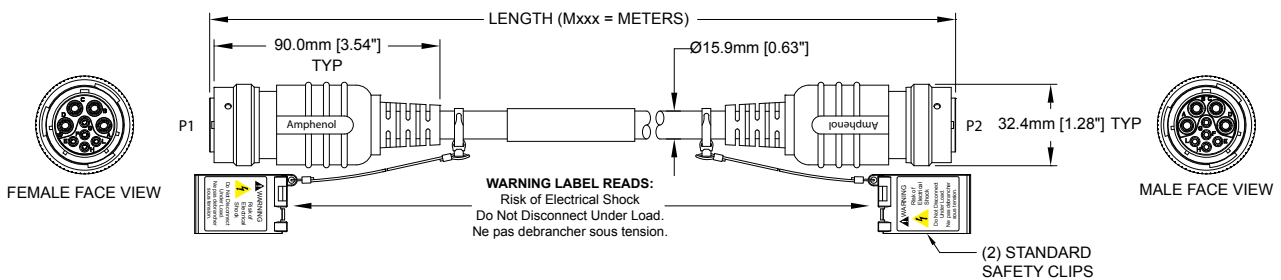

FIG 3: Male Plug to Female Plug, Straight, 9 Position



All Dimensions in: mm [inch]

Dimensional Drawings, cont.

FIG 4: Male, Receptacle, Straight, 9 Position

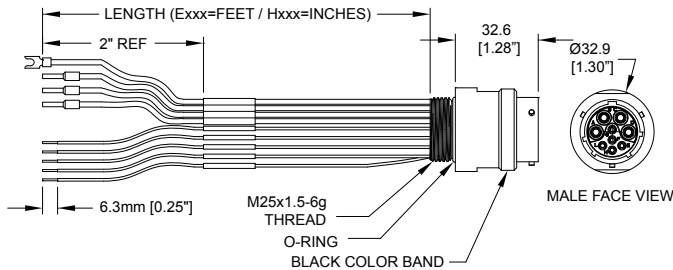
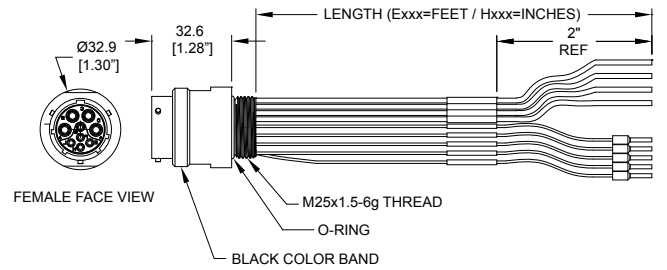
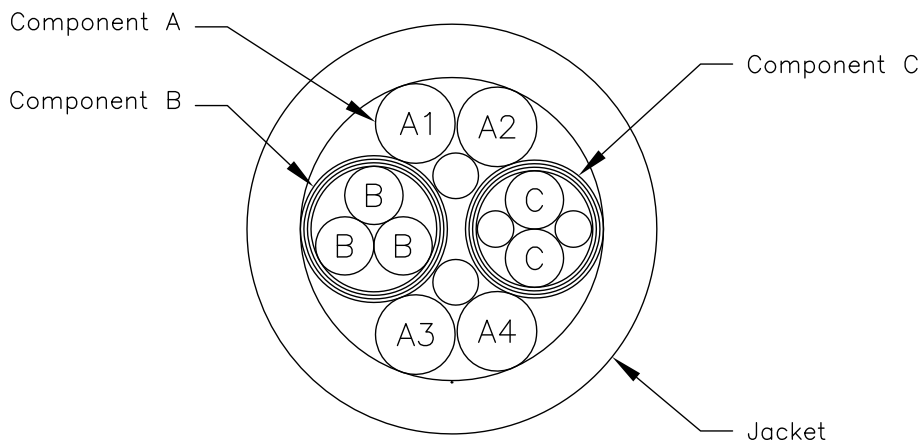

FIG 5: Female, Receptacle, Straight, 9 Position



All Dimensions in: mm [inch]



1.0 Component A – 13 AWG

13 AWG: Bare Copper
Insulation: PVC/Nylon

2.0 Component B – Shielded Triad – 18 AWG

18 AWG: Bare Copper
Insulation: PVC/Nylon
Triad: (3) Conductors Cabled Together
Binder: PTFE Tape
Shield: Tinned Copper Spiral Shield, 95% Coverage
Separator: PTFE Tape

3.0 Component C – Shielded Pair – 18 AWG

18 AWG: Bare Copper
Insulation: PVC/Nylon
Fillers: Solid PVC
Pair: (2) Conductors Cabled Together with Fillers
Binder: PTFE Tape
Shield: Tinned Copper Spiral Shield, 95% Coverage
Separator: PTFE Tape

4.0 Construction

Core: (4) Component A, (1) Component B, (1) Component C and Solid Fillers as required for roundness.

Jacket: .070" TPE, Color: Yellow
Diameter: .631" Nominal
Print Legend: AMPHENOL SINE SYSTEMS KA-56576 (UL File #)
4/C 13 AWG + 5/C 18 AWG (UL) TYPE TC-ER
90C DRY 75C WET 600V SUN RES DIR BUR ---
(CSA FILE #) CSA AWM I/II A/B 90C 600V FT4

COLOR CODE

| Component | COLOR |
|-----------|-------------------------|
| A1 | Black and printed "L1" |
| A2 | Black and printed "L2" |
| A3 | Black and printed "L3" |
| A4 | Green/Yellow |
| B | White, Orange and Green |
| C | White and Red |

6.0 Physical & Electrical Characteristics

Temperature Rating: 90°C
Voltage Rating: 600V

Design Intended to Meet:
10M cycles @ 10x O.D.
Torsional – 100K cycles ±180° @ 1 Meter

7.0 Standards

UL: TYPE TC-ER
CSA: AWM I/II A/B FT4
RoHS COMPLIANT

VersaBOSS™ MC
Cable Specifications



Amphenol Sine Systems







This page intentionally left blank.

Powerflex - 9 Position Specifications

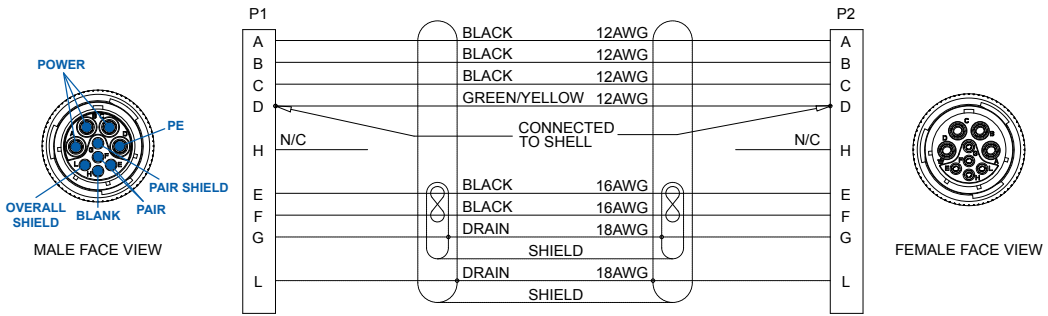
| | | | |
|-----------------------|--|------------------------------|----------------------------|
| Housing Body | Zinc Die-cast, Nickel-plated | Insulation Resistance (Min.) | 5000M OHMS |
| Coupling Nut | Aluminum Alloy, Nickel-plated | Dielectric Test Voltage | 2200V |
| Wave Springs | Stainless Steel | Temperature Range | -40°C to 105°C |
| Insulation Insert | Thermoplastic, UL 94/V-0 | Protection | IP67 (Mated Condition) |
| Contacts | Gold Flash-plating over Copper Alloy | Mating Cycles | >500 |
| Seal and O-Rings | NBR (Nitrile Butadiene Rubber) | Vibration Resistance | Per MIL-STD-202 Method 204 |
| Overmold Material | Polyurethane | Thermal Shock | Per MIL-STD-202 Method 207 |
| Cable Jacket Material | High Flex: TPE, Yellow; Static: PVC, Black | 48 Hour Salt Spray | Per MIL-STD-202 Method 101 |





Powerflex - 9 Position Cable Assemblies

Mxxx = length in meters

| 9 Position; 600V Power; 600V Signal (Up to 20A Power, 5A Signal); Keying Position - X | |
|---|---|
| Wiring Diagram |  |
| Number of Contacts | (4) 12AWG, (2 Pair) 16AWG VFD Cables are 9 pin insert configurations that utilize only 8 pins. |
| Cable Type | High-Flex, TPE, Yellow Jacket Static, PVC, Black Jacket |
| Male Straight, Single-rated, Yellow Overmold <i>(See FIG 1, Pg 83)</i> |  <p>P30706-Mxxx</p>  <p>P30708-Mxxx</p> |
| Female Straight, Single-rated, Yellow Overmold <i>(See FIG 2, Pg 83)</i> |  <p>P30707-Mxxx</p>  <p>P30709-Mxxx</p> |
| Male/Female Straight, Single-rated, Yellow Overmold <i>(See FIG 3, Pg 83)</i> |  <p>P30412-Mxxx</p>  <p>P30618-Mxxx</p> |

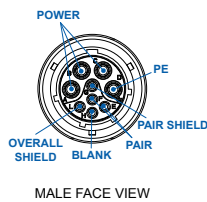
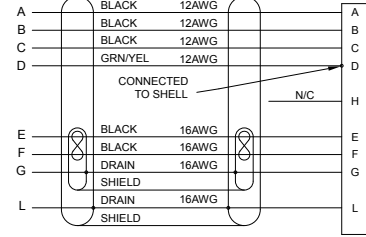
Powerflex - 9 Position Receptacles

Exxx = length in feet, Hxxx = length in inches

| 9 Position; 600V Power; 600V Signal (Up to 20A Power, 5A Signal); Keying Position - X | | | | | | | | | | | | | | | | | | | | | | | | | | | | |
|---|---|--|-------------|---|---|-------------|---|---|-------------|---|---|---------------|---|---|-------------|---|---|-------------|---|---|-------------|---|---|-------------|---|---|-------------------------------|--|
| Male Face View |  <table border="1" data-bbox="590 448 813 683"> <tr><td>A</td><td>BLACK 12AWG</td><td>A</td></tr> <tr><td>B</td><td>BLACK 12AWG</td><td>B</td></tr> <tr><td>C</td><td>BLACK 12AWG</td><td>C</td></tr> <tr><td>D</td><td>GRN/YEL 12AWG</td><td>D</td></tr> <tr><td>E</td><td>BLACK 16AWG</td><td>E</td></tr> <tr><td>F</td><td>BLACK 16AWG</td><td>F</td></tr> <tr><td>G</td><td>GREEN 16AWG</td><td>G</td></tr> <tr><td>L</td><td>GREEN 16AWG</td><td>L</td></tr> <tr><td>H</td><td>DUMMY PLUG 1/2" PC HEATSHRINK</td><td></td></tr> </table>   | A | BLACK 12AWG | A | B | BLACK 12AWG | B | C | BLACK 12AWG | C | D | GRN/YEL 12AWG | D | E | BLACK 16AWG | E | F | BLACK 16AWG | F | G | GREEN 16AWG | G | L | GREEN 16AWG | L | H | DUMMY PLUG 1/2" PC HEATSHRINK | |
| A | BLACK 12AWG | A | | | | | | | | | | | | | | | | | | | | | | | | | | |
| B | BLACK 12AWG | B | | | | | | | | | | | | | | | | | | | | | | | | | | |
| C | BLACK 12AWG | C | | | | | | | | | | | | | | | | | | | | | | | | | | |
| D | GRN/YEL 12AWG | D | | | | | | | | | | | | | | | | | | | | | | | | | | |
| E | BLACK 16AWG | E | | | | | | | | | | | | | | | | | | | | | | | | | | |
| F | BLACK 16AWG | F | | | | | | | | | | | | | | | | | | | | | | | | | | |
| G | GREEN 16AWG | G | | | | | | | | | | | | | | | | | | | | | | | | | | |
| L | GREEN 16AWG | L | | | | | | | | | | | | | | | | | | | | | | | | | | |
| H | DUMMY PLUG 1/2" PC HEATSHRINK | | | | | | | | | | | | | | | | | | | | | | | | | | | |
| Number of Contacts | (4) 12AWG, (2) 16AWG, (2) 18AWG VFD Receptacles are 9 pin insert configurations that utilize only 8 pins. | | | | | | | | | | | | | | | | | | | | | | | | | | | |
| Type | Male | Female | | | | | | | | | | | | | | | | | | | | | | | | | | |
| Yellow Color Band <i>(See FIG 4 and 5, Pg 84)</i> |  P30545- (Select either Exxx or Hxxx) |  P30544- (Select either Exxx or Hxxx) | | | | | | | | | | | | | | | | | | | | | | | | | | |

Dimensional Drawings

FIG 1: Male, Plug, Straight, 9 Position

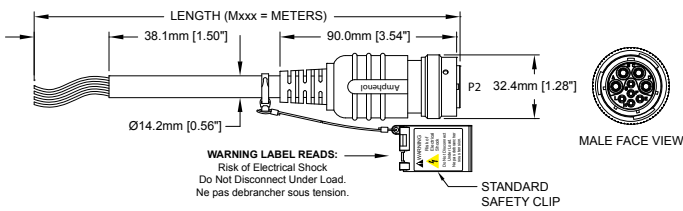

FIG 2: Female, Plug, Straight, 9 Position

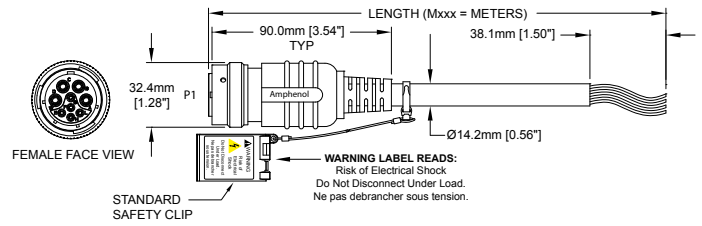
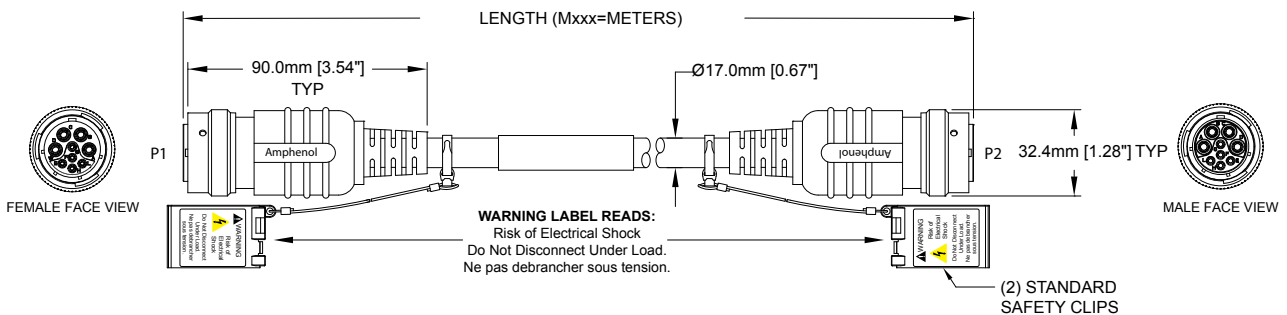

FIG 3: Male Plug to Female Plug, Straight, 9 Position



All Dimensions in: mm [inch]

Dimensional Drawings, cont.

FIG 4: Male, Receptacle, Straight, 9 Position

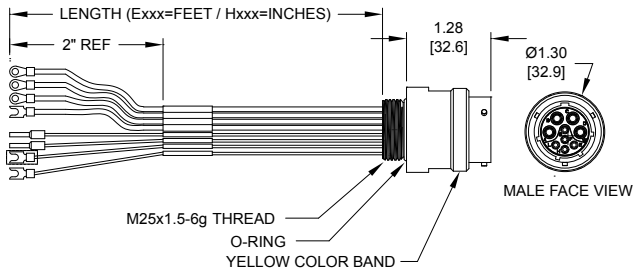
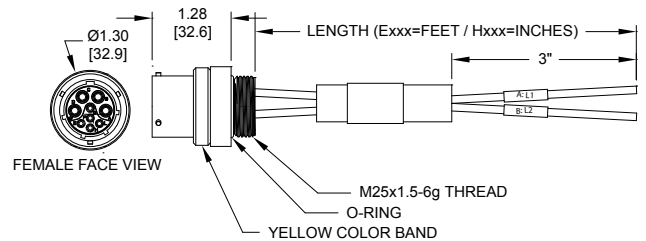
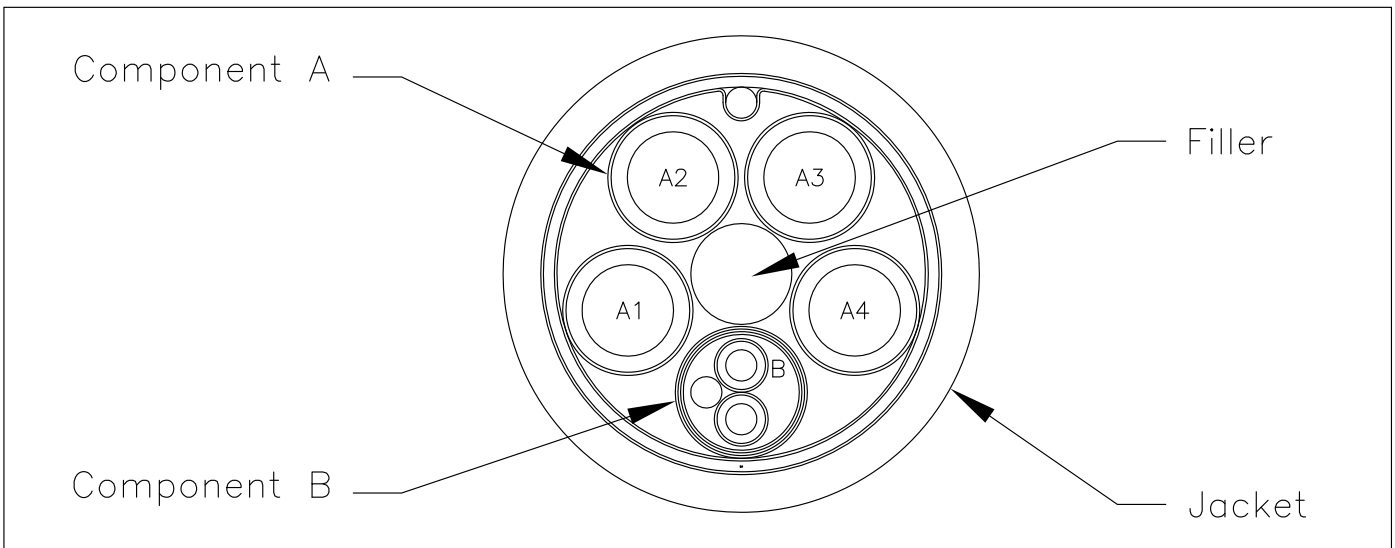

FIG 5: Female, Receptacle, Straight, 9 Position



All Dimensions in: mm [inch]



1.0 Component A – 12 AWG

12 AWG: Bare Copper
Insulation: PVC/Nylon

2.0 Component B – Shielded Pair – 16 AWG

16 AWG: Bare Copper
Insulation: PVC/nylon
Pair: (2) Conductors Cabled Together
Binder: Tape
Drain Wire: 18 AWG Tinned Copper
Shield: Alum–Mylar Tape, Alum Facing In
Separator: Tape

3.0 Construction

Core: (4) Component A, (1) Component B and Fillers as required for roundness.
Binder: Tape
Drain Wire: 18 AWG Tinned Copper
Shield: Foil, Alum–Mylar–Alum
Shield: Tinned Copper Braided Shield, 95% Coverage
Binder: Tape
Jacket: .070" TPE, Color: Yellow
Diameter: 0.680" Nominal

4.0 Print Legend

AMPHENOL SINE SYSTEMS KA-56628 (UL File #)
4/C 12 AWG + 1/PR 16 AWG (UL) TYPE TC-ER
90C DRY 75C WET 600V SUN RES DIR BUR ---
(CSA FILE #) CSA AWM 1/II A/B 90C 600V FT4

COLOR CODE

| Component | COLOR |
|-----------|------------------------|
| A1 | Black and printed "L1" |
| A2 | Black and printed "L2" |
| A3 | Black and printed "L3" |
| A4 | Green/Yellow |
| B | Black #5 and Black #6 |

5.0 Physical & Electrical Characteristics

Temperature Rating: 90°C
Voltage Rating: 600V

Design Intended to Meet:
5M cycles @ 10x O.D.

6.0 Standards

UL: TYPE TC-ER
CSA: AWM 1/II A/B FT4
RoHS COMPLIANT

VersaBOSS™ Powerflex
Cable Specifications



Amphenol Sine Systems

This page intentionally left blank.

ControlPower™

The **ControlPower™** line is a 6 pin/5 use option to support the ongoing requests from our customers seeking alternatives from other cable assembly providers. This system utilizes UL Dual-rated TC-ER STOOW and CSA STOOW cable.



6 Position/5 Used - Tees

| Tee - Description | See FIG/Pg | Part Number |
|--------------------------|--------------|-------------|
| Tee, E-Stop In, Black | FIG 7, Pg 89 | P29313 |
| Tee, E-Stop Out, Red | FIG 8, Pg 89 | P29328 |
| Tee, 4 Pos., Mini, Black | FIG 9, Pg 89 | P30965 |



6 Position/5 Used - Shorting Plugs

| Shorting Plug - Description | See FIG/Pg | Part Number |
|-----------------------------|---------------|-------------|
| Plug, E-Stop Out, Black | FIG 10, Pg 89 | P29326 |
| Plug, E-Stop In, Red | FIG 11, Pg 89 | P29325 |



Dustcaps

| Dustcap - Description | See FIG/Pg | Part Number |
|--------------------------|---------------|-------------|
| Male, Internal Threads | FIG 12, Pg 89 | P29044 |
| Female, External Threads | FIG 13, Pg 89 | P29045 |



Dimensional Drawings

Mxxx = length in meters

FIG 1: Male, Plug, Straight, 6P/5U

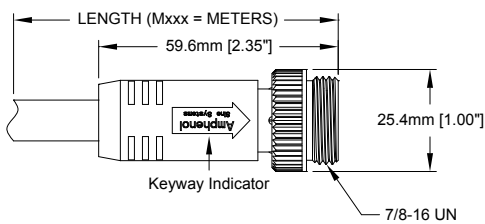

FIG 2: Female, Plug, Straight, 6P/5U

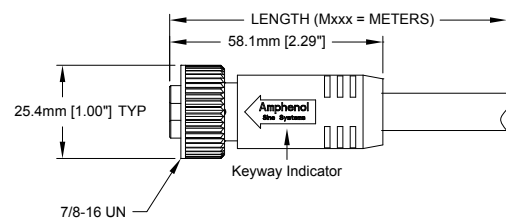

FIG 3: Male, Plug, 90°, 6P/5U

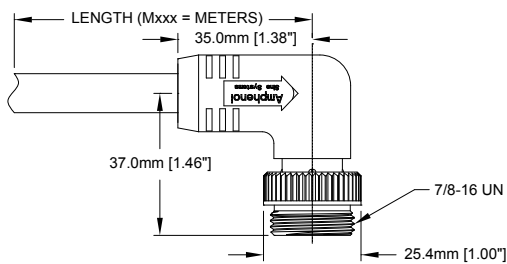
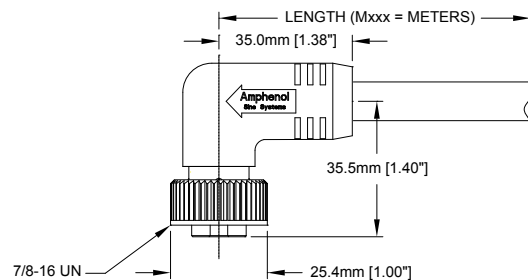

FIG 4: Female, Plug, 90°, 6P/5U



All Dimensions in: mm [inch]

Dimensional Drawings, cont.

Mxxx = length in meters

FIG 5: Male, Receptacle, Straight, 6P/5U

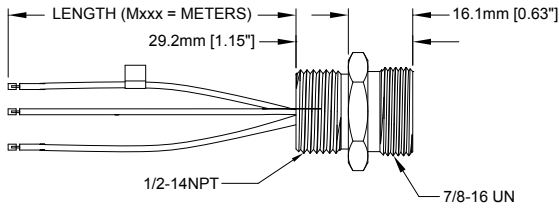

FIG 6: Female, Receptacle, Straight, 6P/5U

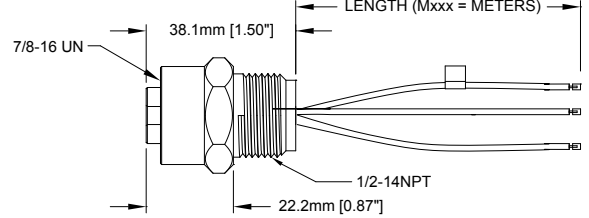

FIG 7: Tee, E-Stop In, Black, 6P/5U

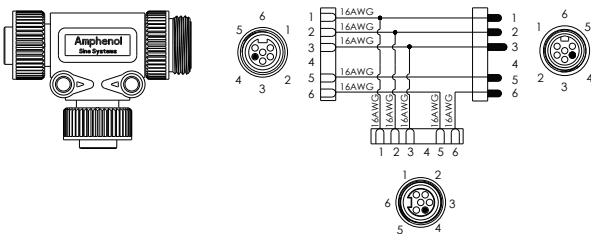

FIG 8: Tee, E-Stop Out, Red, 6P/5U

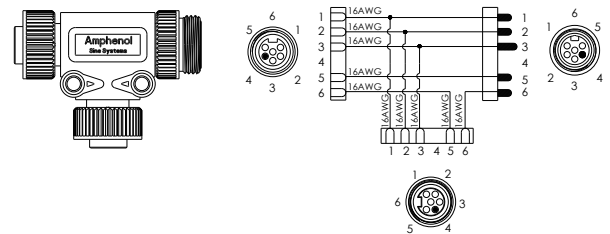

FIG 9: Tee, Mini, Black, 4 Pos.

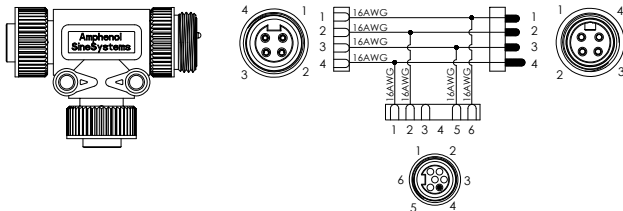

FIG 10: Shorting Plug, E-Stop In, Black, 6P/5U

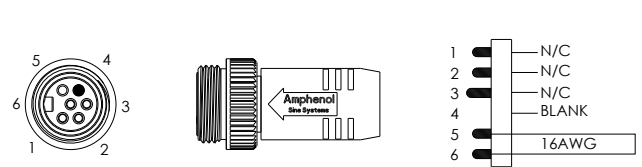

FIG 11: Shorting Plug, E-Stop Out, Red, 6P/5U

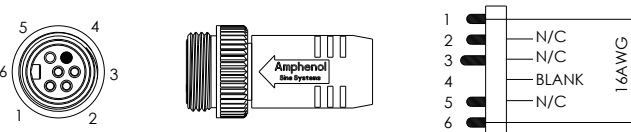

FIG 12: Male, Dustcap, Internal Threads

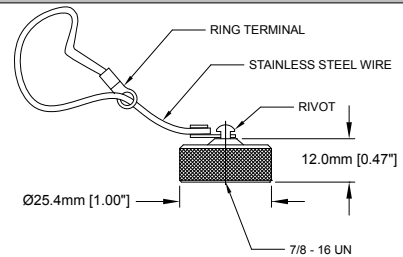
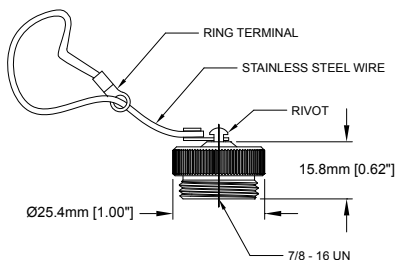

FIG 13: Female, Dustcap, External Threads



All Dimensions in: mm [inch]

miniBOSS™ M22

Power Distribution System

The miniBOSS™ M22 system is offered in 2, 3, 4, 5 and 6 position configurations. This system allows for cost-effective power and signal distribution, utilizing UL ST00W/CSA Type ST cable, as well as High Flex TPE jacketed UL Listed TC-ER cable.



miniBOSS™ M22 (7/8")



2, 3, 4, 5 and 6 Position Specifications

| | | | |
|--------------------|--|---------------------|--|
| Temperature Range | -20°C to +105°C | Cable Jacket | PVC, Yellow |
| Housing Body/Face | Oil-resistant PVC | Cable Rating | UL Listed Type STOOW |
| Coupling Nut | Machined Aluminum, Anodized | Cable Voltage | 600V, 105°C |
| Receptacle Housing | Machined Aluminum, Anodized | Cable Certification | CSA certified type ST |
| Contacts | Copper Alloy | Cable Insulation | PVC insulated #16AWG stranded copper (65x34) |
| Contact Plating | 5µ inches (min) Gold, over 25µ inches (min) Nickel | Cable Diameter | 2/C - .37" (9.4mm); 3/C - .41" (10.4mm) 4/C - .42" (10.7mm); 5/C - .50" (12.7mm) 6/C - .54" (13.7mm) |

2, 3, 4, 5 and 6 Position Cable Assemblies and Receptacles

Mxxx = length in meters

| | 2P | 3P | 4P | 5P | 6P |
|-----------------------|------------------|---------------------------|----------------------------------|--|--|
| Male Face View | | | | | |
| Color Code | 1-White, 2-Black | 1-Green, 2-Black, 3-White | 1-Black, 2-White, 3-Red, 4-Green | 1-White, 2-Red, 3-Green, 4-Orange, 5-Black | 1-White, 2-Red, 3-Green, 4-Orange, 5-Black, 6-Blue |
| Current | 13A | | 10A | 10A | 8A |
| Voltage | 600V | | | | |
| Conductor | 16AWG | | | | |
| Receptacle Wire Style | MTW and AWM 1015 | | | | |

| Plug - Description | See FIG/Pg | 2P | 3P | 4P | 5P | 6P |
|---|-------------------------------|----------------|----------------|----------------|----------------|----------------|
| M-Str., Int. Thread | FIG 1, Pg 90 | MN23AC01Mxxx | MN33AC01Mxxx | MN43AC01Mxxx | MN53AC01Mxxx | MN63AC01Mxxx |
| M-90°, Ext. Thread | FIG 5, Pg 91 | MN23BC01Mxxx | MN33BC01Mxxx | MN43BC01Mxxx | MN53BC01Mxxx | MN63BC01Mxxx |
| F-Str, Int. Thread | FIG 2, Pg 90 | MN24AC01Mxxx | MN34AC01Mxxx | MN44AC01Mxxx | MN54AC01Mxxx | MN64AC01Mxxx |
| F-90°, Int. Thread | FIG 4, Pg 90 | MN24BC01Mxxx | MN34BC01Mxxx | MN44BC01Mxxx | MN54BC01Mxxx | MN64BC01Mxxx |
| M-Str, Ext. Thread/ F-Str, Internal Thread | FIG 3, Pg 90/ FIG 2, Pg 90 | MN27A4AC01Mxxx | MN37A4AC01Mxxx | MN47A4AC01Mxxx | MN57A4AC01Mxxx | MN67A4AC01Mxxx |
| M-90°, Ext. Thread/ F-Str, Internal Thread | FIG 5, Pg 91/ FIG 2, Pg 90 | MN27B4AC01Mxxx | MN37B4AC01Mxxx | MN47B4AC01Mxxx | MN57B4AC01Mxxx | MN67B4AC01Mxxx |
| M-Str, Ext. Thread/ F-90°, Int. Thread | FIG 3, Pg 90/ FIG 4, Pg 90 | MN27A4BC01Mxxx | MN37A4BC01Mxxx | MN47A4BC01Mxxx | MN57A4BC01Mxxx | MN67A4BC01Mxxx |
| M-90°, Ext. Thread/ F-90°, Int. Thread | FIG 5, Pg 91/ FIG 4, Pg 90 | MN27B4BC01Mxxx | MN37B4BC01Mxxx | MN47B4BC01Mxxx | MN57B4BC01Mxxx | MN67B4BC01Mxxx |

| Receptacle - Description | See FIG/Pg | 2P | 3P | 4P | 5P | 6P |
|--------------------------|--------------|--------------|--------------|--------------|--------------|--------------|
| M, Ext. Thread | FIG 5, Pg 91 | MN21PW02Mxxx | MN31PW02Mxxx | MN41PW02Mxxx | MN51PW02Mxxx | MN61PW02Mxxx |
| F, Ext. Thread | FIG 6, Pg 91 | MN22PW02Mxxx | MN32PW02Mxxx | MN42PW02Mxxx | MN52PW02Mxxx | MN62PW02Mxxx |
| F, Int. Thread | FIG 7, Pg 91 | MN24PW02Mxxx | MN34PW02Mxxx | MN44PW02Mxxx | MN54PW02Mxxx | MN64PW02Mxxx |



3, 4 and 5 Position - Tees

| Description | See FIG/Pg | Part Number |
|-------------------|---------------|-------------|
| 3 Pos., 600V, 13A | FIG 8, Pg 91 | P29309 |
| 4 Pos., 600V, 10A | FIG 9, Pg 91 | P29310 |
| 5 Pos., 600V, 8A | FIG 10, Pg 91 | P29311 |



Dustcaps and Threaded Unions

| Description | See FIG/Pg | Part Number |
|--|---------------|-------------|
| Male, Internal Threads | FIG 11, Pg 91 | P29044 |
| Female External Threads | FIG 12, Pg 91 | P29045 |
| Aluminum Threaded Union (for male and female connectors) | FIG 13, Pg 91 | 10-54938 |



Dimensional Drawings

Mxxx = length in meters

FIG 1: Male, Plug, Straight, Internal Threads

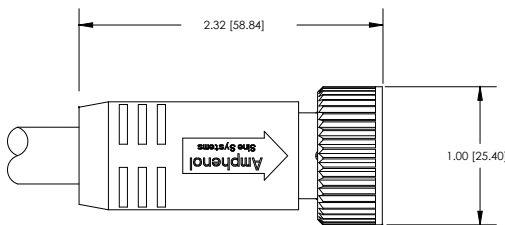

FIG 2: Female, Plug, Straight, Internal Threads

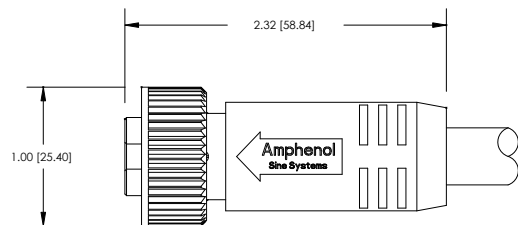

FIG 3: Male, Plug, Straight, External Threads

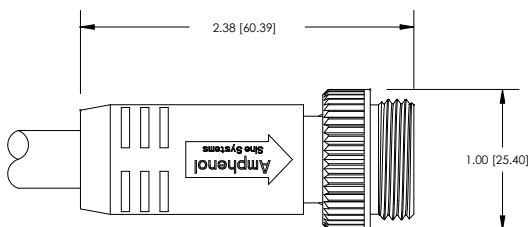
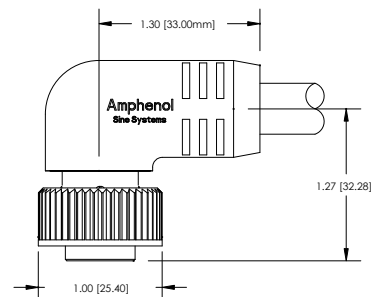

FIG 4: Female, Plug, 90°, Internal Threads



All Dimensions in: mm [inch]

miniBOSS™ M22 (7/8")

Dimensional Drawings, cont.

Mxxx = length in meters

FIG 5: Male, Plug, 90°, External Threads

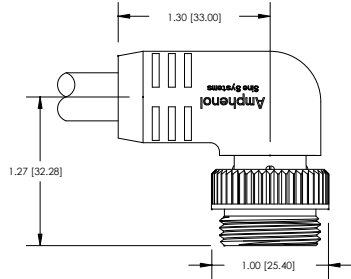

FIG 6: Male/Female, Receptacle, External Threads

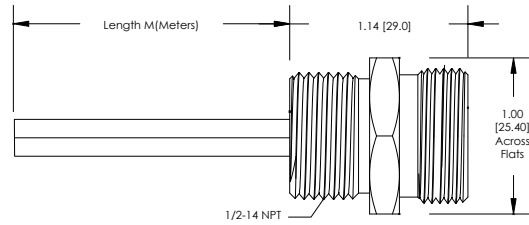

FIG 7: Female, Receptacle, Internal Threads

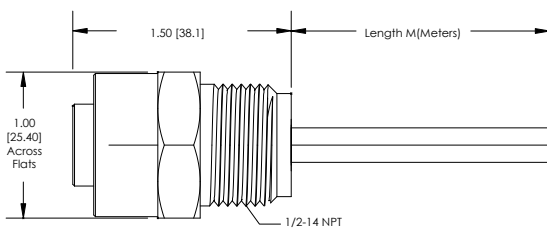

FIG 8: Tee, 3 Position

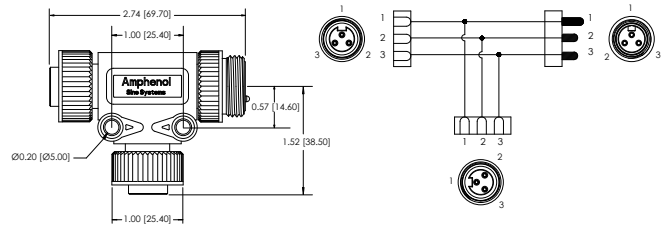

FIG 9: Tee, 4 Position

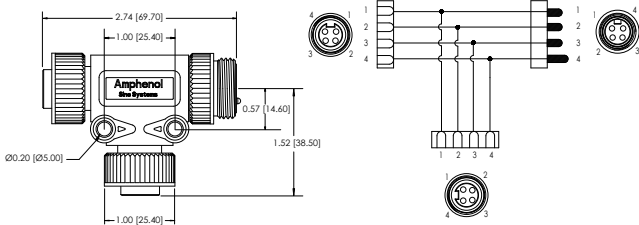

FIG 10: Tee, 5 Position

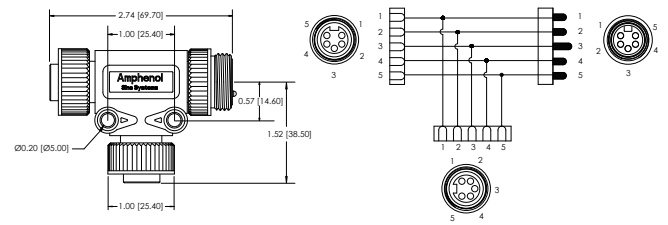

FIG 11: Male, Dustcap, Internal Threads

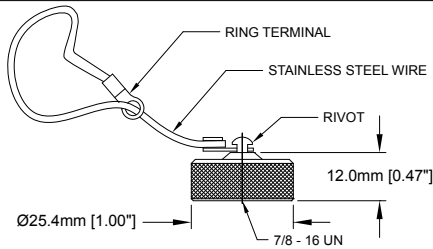

FIG 12: Female, Dustcap, External Threads

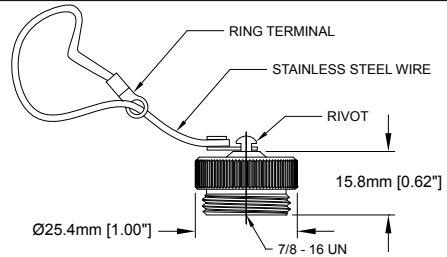
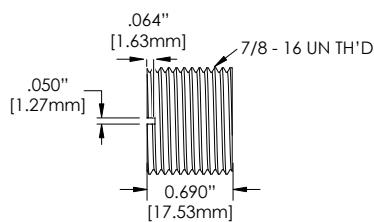

FIG 13: Threaded Union



All Dimensions in: mm [inch]

microBOSS™ M12

Signal Distribution System

The microBOSS™ M12 system is offered in 3, 4, and 5 pin configurations that deliver signal to a wide variety of devices, utilizing both UL AWM-style 2661 and CSA AWM I/II A/B cable, as well as Flex and High Flex cable options.



microBOSS™ M12 (1/2")



3, 4 and 5 Position Specifications

| | | | |
|---------------------|--|------------------|--|
| Temperature Range | -20°C to +105°C | Cable Rating | UL Listed Type STOOW |
| Housing Body/Face | Oil-resistant PVC/Nylon 6/6 | Cable Voltage | 600V, 105°C |
| Coupling Nut/O-Ring | Machined Aluminum, Anodized/Nitrile Rubber | Cable Insulation | PVC insulated #22AWG stranded copper (26x36) |
| Receptacle Housing | Machined Aluminum, Anodized | Cable Jacket | PVC, Yellow (22AWG); TPE, Yellow (18AWG) |
| Contacts | Copper Alloy | Contact Plating | 5μ inches (min) Gold, over 25μ inches (min) Nickel |
| Cable Cert. 22AWG | UL AWM Style 2661, CSA AWM I/II A/B, 300V, 105°C; Jacket PVC | Cable Diameter | 3/C - .18" (4.6mm); 4/C - .20" (5.1mm); 5/C - .23" (5.8mm) |
| Cable Cert. 18AWG | UL 18AWG/4C ITC 105°C or PLTC 105°C or CSA AWM I/II AB 90°C 300V FT4; Jacket TPE | | |

3, 4 and 5 Position Cable Assemblies and Receptacles

Mxxx = length in meters

| | 3P | 4P | 5P |
|----------------|--|---|--|
| Male Face View | | | |
| Color Code | 1-Brown, 2-Not Used, 3-Blue, 4-Black, 5-Not Used | 1-Brown, 2-White, 3-Blue, 4-Black, 5-Not Used | 1-Brown, 2-White, 3-Blue, 4-Black, 5-Green |
| Current | 4A | 4A | 4A |
| Voltage | 300V | 300V | 300V |

| Plug Description | See FIG/Pg | 3P | 4P | | 5P | |
|---------------------|--------------------|----------------|----------------|----------------|----------------|----------------|
| Plug Wire Style | - | AWM UL 2661 | AWM UL 2661 | AWM UL 2661 | AWM UL 2661 | AWM UL 2661 |
| Conductor | - | 22AWG | 22AWG | 18AWG | 22AWG | 18AWG |
| Male Straight | FIG 1, Pg 94 | MC37AC05Mxx | MC47AC05Mxx | MC47AC09Mxx | MC57AC05Mxx | MC57AC09Mxx |
| Male 90° | FIG 3, Pg 94 | MC37BC05Mxx | MC47BC05Mxx | MC47BC09Mxx | MC57BC05Mxx | MC57BC09Mxx |
| Female Straight | FIG 2, Pg 94 | MC34AC05Mxx | MC44AC05Mxx | MC44AC09Mxx | MC54AC05Mxx | MC54AC09Mxx |
| Female 90° | FIG 4, Pg 94 | MC34BC05Mxx | MC44BC05Mxx | MC44BC09Mxx | MC54BC05Mxx | MC54BC09Mxx |
| Male Str/Female Str | FIG 1 and 2, Pg 94 | MC37A4AC05Mxxx | MC47A4AC05Mxxx | MC47A4AC09Mxxx | MC57A4AC05Mxxx | MC57A4AC09Mxxx |
| Male 90°/Female Str | FIG 3 and 2, Pg 94 | MC37B4AC05Mxxx | MC47B4AC05Mxxx | MC47B4AC09Mxxx | MC57B4AC05Mxxx | MC57B4AC09Mxxx |
| Male Str/Female 90° | FIG 1 and 4, Pg 94 | MC37A4BC05Mxxx | MC47A4BC05Mxxx | MC47A4BC09Mxxx | MC57A4BC05Mxxx | MC57A4BC09Mxxx |
| Male 90°/Female 90° | FIG 3 and 4, Pg 94 | MC37B4BC05Mxxx | MC47B4BC05Mxxx | MC47B4BC09Mxxx | MC57B4BC05Mxxx | MC57B4BC09Mxxx |

| Receptacle Description | See FIG/Pg | 3P | 4P | | 5P | |
|--------------------------|--------------|-------------|-------------|-------|-------------|-------|
| Receptacle Wire Style | - | UL1061 | UL1061 | - | UL1061 | - |
| Conductor | - | 22AWG | 22AWG | 18AWG | 22AWG | 18AWG |
| Male, External Threads | FIG 5, Pg 94 | MC31PW03Mxx | MC41PW03Mxx | - | MC51PW03Mxx | - |
| Female, Internal Threads | FIG 6, Pg 94 | MC34PW03Mxx | MC44PW03Mxx | - | MC54PW03Mxx | - |



M12 Splitters



| Description | See FIG/Pg | (1) 4 Pos. to (2) 3 Pos. | (1) 4 Pos. to (2) 4 Pos. |
|--------------------------|--------------------|--------------------------|--------------------------|
| Male/Female Straight | FIG 7 and 8, Pg 95 | P29332 | P29333 |
| Male Straight, Female 90 | FIG 9, Pg 95 | - | P29334 |

Dimensional Drawings

FIG 1: Male, Plug, Straight, External Threads

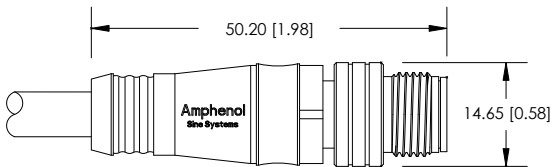

FIG 2: Female, Plug, Straight, Internal Threads

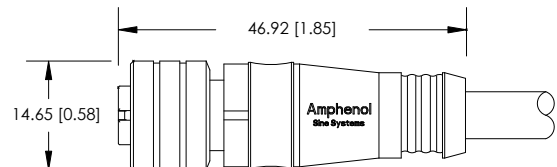

FIG 3: Male, Plug, 90°, External Threads

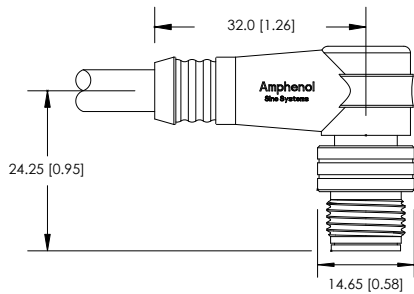

FIG 4: Female, Plug, 90°, Internal Threads

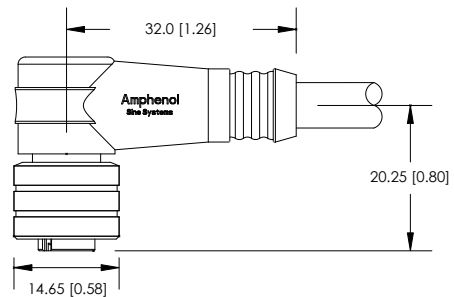

FIG 5: Male, Receptacle, Straight, External Threads

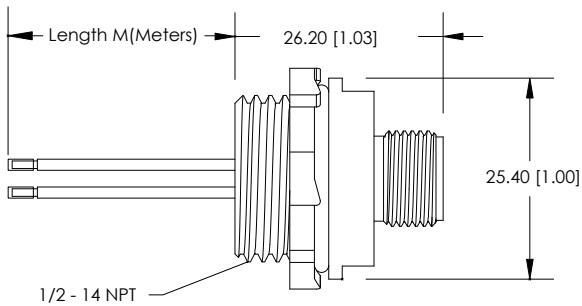
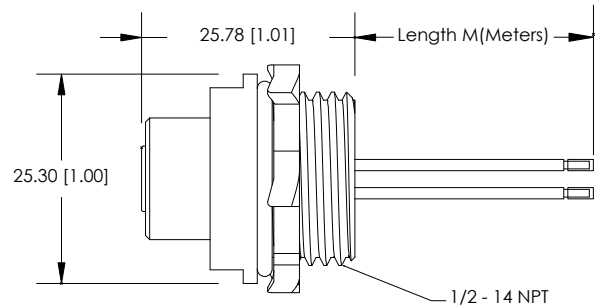

FIG 6: Female, Receptacle, Straight, Internal Threads



All Dimensions in: mm [inch]

microBOSS™ M12 (1/2")



Dimensional Drawings, cont.

Mxxx = length in meters

FIG 7: Male to Female, Splitter, Straight - (1) 4 Pos. to (2) 4 Pos.

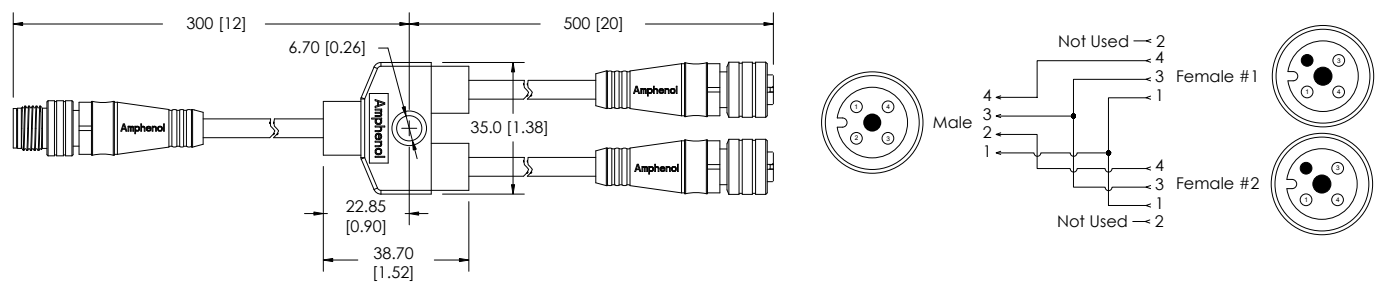

FIG 8: Male to Female, Splitter, Straight - (1) 4 Pos. to (2) 4 Pos.

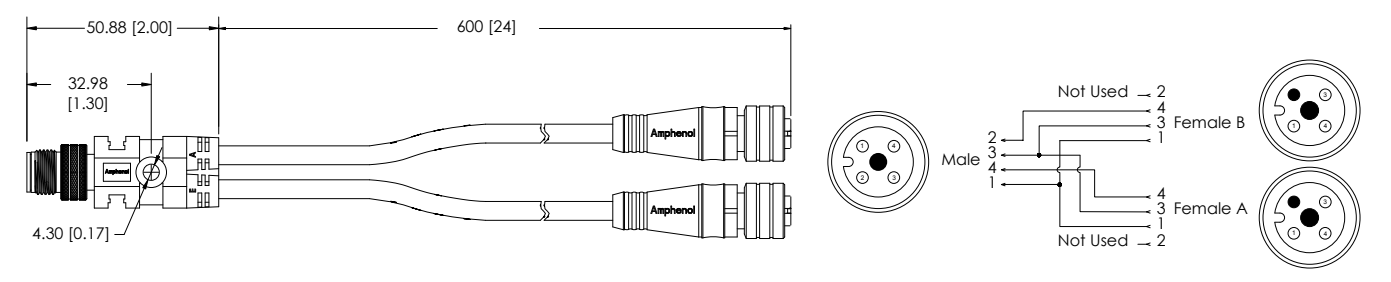
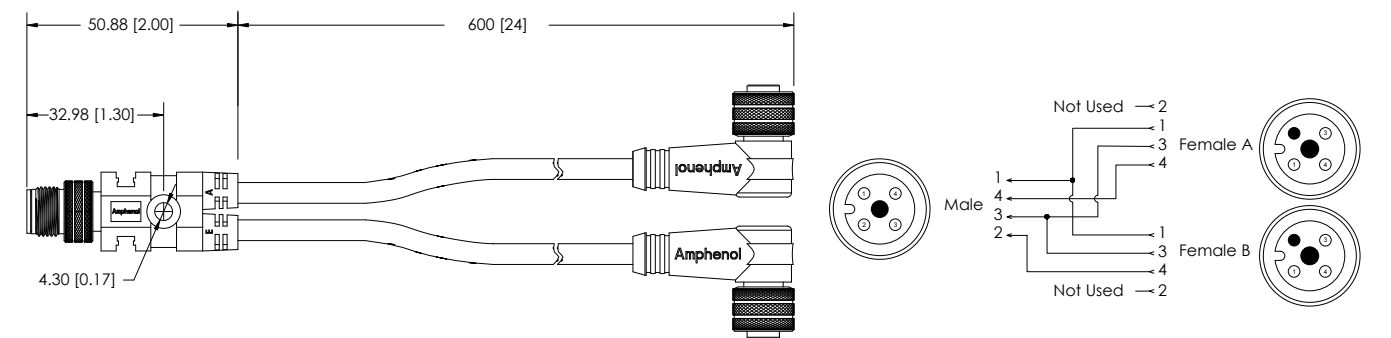

FIG 9: Male Straight to Female 90°, Splitter - (1) 4 Pos. to (2) 4 Pos.



All Dimensions in: mm [inch]

DeviceNet™

DeviceNet™ cables are available in Mini Thick, Mini Thin and Micro Thin sizes, set to cover the many different demands in the field, utilizing UL Type CL2 or PLTC and CSA AWM I/II A/B FT4 cable, as well as Flex and High Flex cable options.





DeviceNet™ System

5 Position Specifications

| | | | |
|--------------------|---|-----------------|--|
| Temperature Range | -20°C to +105°C | Cable Jacket | PVC, Gray |
| Housing Body/Face | Oil-resistant PVC/PVC (Mini), Nylon 6/6 (Micro) | Contacts | Copper Alloy |
| Coupling Nut | Aluminum, Anodized | Contact Plating | Mini: 5μ inches (min) Gold, over 25μ inches (min) Nickel; Micro: 5μ inches (min) Gold, over 5μ inches (min) Nickel |
| Receptacle Housing | Aluminum, Anodized | | |

| Cable: Thick Static - 12.07mm (.457") | Cable: Thin Static - 6.86mm (.270") |
|---|---|
| Two individually shielded pair inner conductors | Two individually shielded pair inner conductors |
| Power pair PVC insulated 2 x #15 AWG stranded copper (19 x #28) | Power pair PVC insulated 2 x #22 AWG stranded copper (19 x #34) |
| Data pair PVC insulated 2 x #18 AWG stranded copper (19 x #30) | Data pair PVC insulated 2 x #24 AWG stranded copper (19 x #36) |
| Drain wire #18 AWG stranded copper (19 x #30) | Drain wire #22 AWG stranded copper (19 x #34) |
| UL type CL2 or PLTC; CSA AWM I/II A/B FT4; 300 V, 80° C | UL type CL2 or PLTC; CSA AWM I/II A/B FT4; 300 V, 105° C |

5 Position Cable Assemblies and Receptacles

Mxxx = length in meters

| | 5P Mini - Thick | 5P Mini - Thin | 5P Micro - Thin |
|----------------|--|----------------|-----------------|
| Male Face View | | | |
| Conductor | 15/18AWG | 22/24AWG | 22/24AWG |
| Color Code | 1-Drain, 2-Red, 3-Black, 4-White, 5-Blue | | |
| Current | See cable | | |
| Voltage | 300VAC/VDC | | |

| Plug - Description | See FIG/Pg | 5P Mini - Thick | See FIG/Pg | 5P Mini - Thin | See FIG/Pg | 5P Micro - Thin |
|---------------------------|--------------------|-----------------|--------------------|----------------|--------------------|-----------------|
| Male Straight | FIG 1, Pg 98 | MN57AD01Mxxx | FIG 1, Pg 98 | MN57AD02Mxxx | FIG 5, Pg 99 | MC57AD02Mxxx |
| Male 90° | FIG 3, Pg 98 | MN57BD01Mxxx | FIG 3, Pg 98 | MN57BD02Mxxx | FIG 7, Pg 99 | MC57BD02Mxxx |
| Female Straight | FIG 2, Pg 98 | MN54AD01Mxxx | FIG 2, Pg 98 | MN54AD02Mxxx | FIG 6, Pg 99 | MC54AD02Mxxx |
| Female 90° | FIG 4, Pg 98 | MN54BD01Mxxx | FIG 4, Pg 98 | MN54BD02Mxxx | FIG 8, Pg 99 | MC54BD02Mxxx |
| Male/Female Straight | FIG 1 and 2, Pg 98 | MN57A4AD01Mxxx | FIG 1 and 2, Pg 98 | MN57A4AD02Mxxx | FIG 5 and 6, Pg 99 | MC57A4AD02Mxxx |
| Male 90°/ Female Straight | FIG 2 and 3, Pg 98 | MN57B4AD01Mxxx | FIG 2 and 3, Pg 98 | MN57B4AD02Mxxx | FIG 6 and 7, Pg 99 | MC57B4AD02Mxxx |
| Male Straight/Female 90° | FIG 1 and 4, Pg 98 | MN57A4BD01Mxxx | FIG 1 and 4, Pg 98 | MN57A4BD02Mxxx | FIG 5 and 8, Pg 99 | MC57A4BD02Mxxx |
| Male/Female 90° | FIG 3 and 4, Pg 98 | MN57B4BD01Mxxx | FIG 3 and 4, Pg 98 | MN57B4BD02Mxxx | FIG 7 and 8, Pg 99 | MC57B4BD02Mxxx |

| Receptacle - Description | See FIG/Pg | 5P Mini - Thick | See FIG/Pg | 5P Mini - Thin | See FIG/Pg | 5P Micro - Thin |
|--------------------------|---------------|-----------------|---------------|----------------|---------------|-----------------|
| Male, External Threads | FIG 9, Pg 99 | MN51PD01Mxxx | FIG 10, Pg 99 | MN51PD02Mxxx | FIG 11, Pg 99 | MC51PD02Mxxx |
| Female, Internal Threads | FIG 12, Pg 99 | MN54PD01Mxxx | FIG 13, Pg 99 | MN54PD02Mxxx | FIG 14, Pg 99 | MC54PD02Mxxx |



5 Position - Terminating Plugs

| Description | See FIG/Pg | Part Number |
|-----------------------|---------------|-------------|
| Male, Plug, 121 OHM | FIG 15, Pg 99 | P29319 |
| Female, Plug, 121 OHM | FIG 16, Pg 99 | P29318 |



5 Position - Tees

| Description | See FIG/Pg | Part Number |
|----------------------------|----------------|-------------|
| 5 Pos., 300V, 8A | FIG 17, Pg 100 | P29312 |
| 5 Pos., 300V, 8A, w/ Diode | FIG 18, Pg 100 | P29329 |



Dustcaps

| Description | See FIG/Pg | Part Number |
|--------------------------|----------------|-------------|
| Male, Internal Threads | FIG 19, Pg 100 | P29044 |
| Female, External Threads | FIG 20, Pg 100 | P29045 |



Dimensional Drawings

FIG 1: Male, Mini, Plug, Straight, External Threads

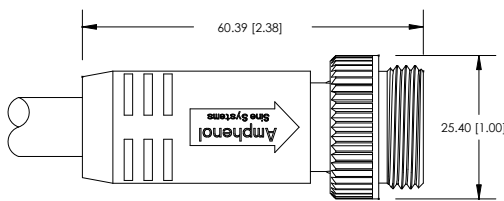

FIG 2: Female, Plug, Mini, Straight, Internal Threads

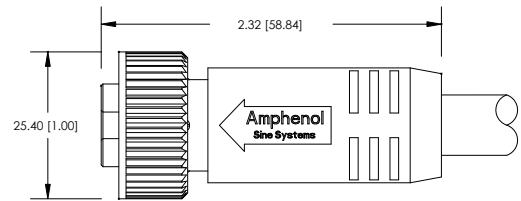

FIG 3: Male, Mini, Plug, 90°, External Threads

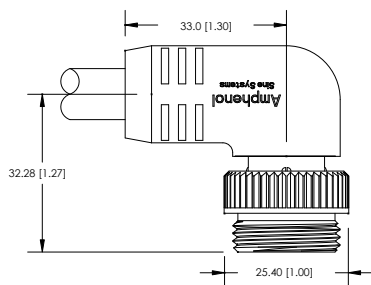
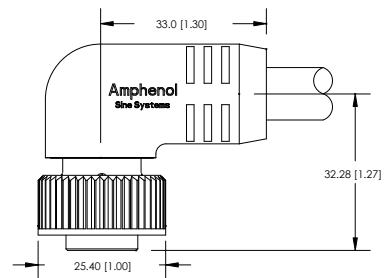

FIG 4: Female, Plug, Mini, 90°, Internal Threads



All Dimensions in: mm [inch]

DeviceNet™ System

Dimensional Drawings, cont.

FIG 5: Male, Plug, Micro, Straight, External Threads

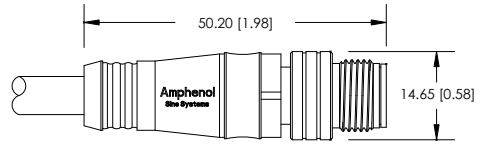

FIG 6: Female, Micro, Plug, Straight, Internal Threads

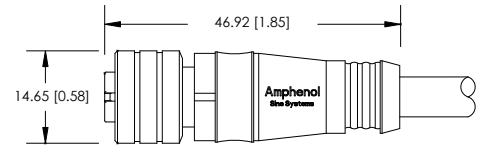

FIG 7: Male, Micro, Plug, 90°, External Threads

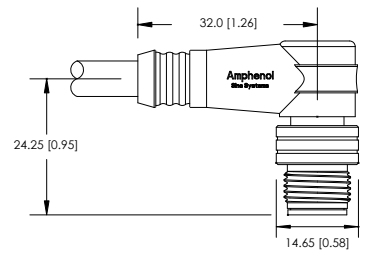

FIG 8: Female, Micro, Plug, 90°, Internal Threads

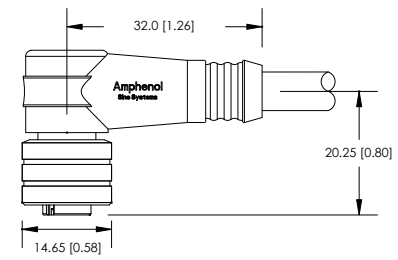

FIG 9: Male, Mini, Receptacle, Thick, External Threads

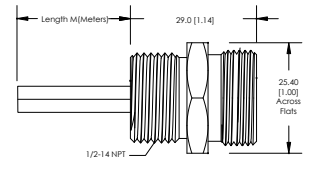

FIG 10: Male, Mini, Receptacle, Thin, External Threads

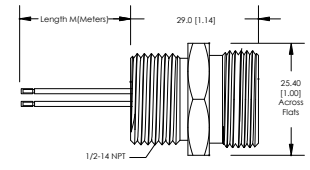

FIG 11: Male, Micro, Receptacle, Thin, External Threads

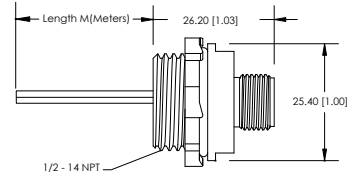

FIG 12: Female, Mini, Receptacle, Thick, Internal Threads

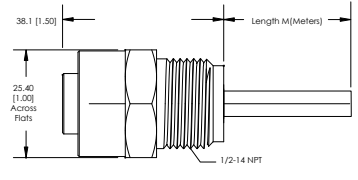

FIG 13: Female, Mini, Receptacle, Thin, Internal Threads

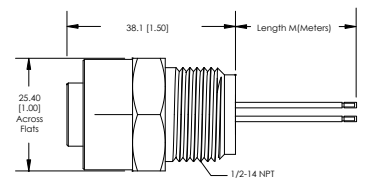

FIG 14: Female, Micro, Receptacle, Thin, Internal Threads

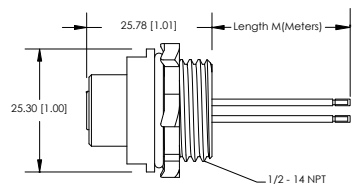

FIG 15: Male, Terminating Plug, Straight, 5 Position

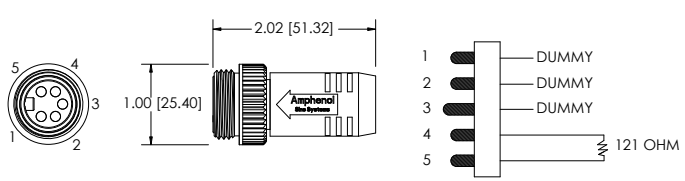
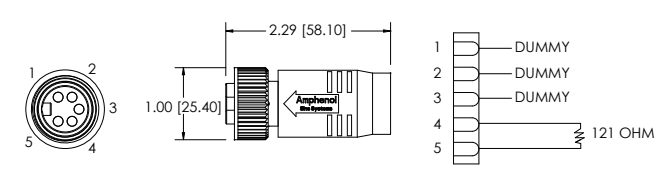

FIG 16: Female, Terminating Plug, Straight, 5 Position



Dimensional Drawings, cont.

FIG 17: Tee, 300V, 8A, 5 Position

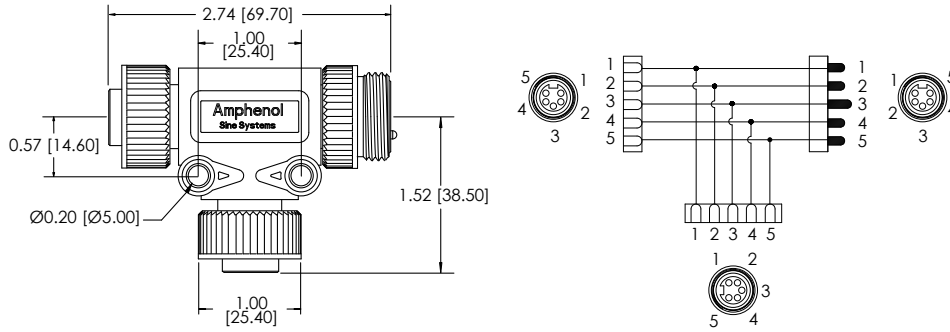

FIG 18: Tee, 300V, 8A, 5 Position, w/ Diode

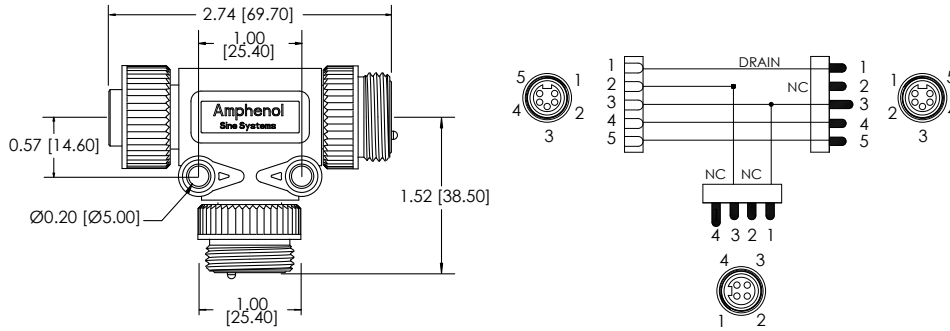

FIG 19: Male, Dustcap, Internal Threads

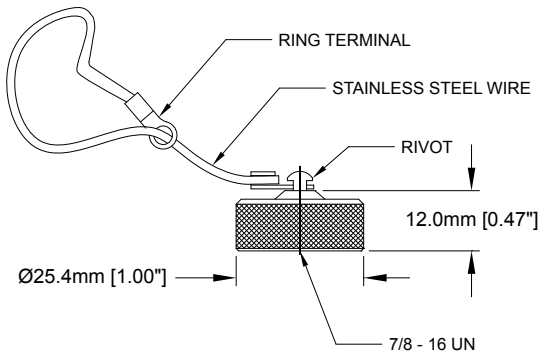
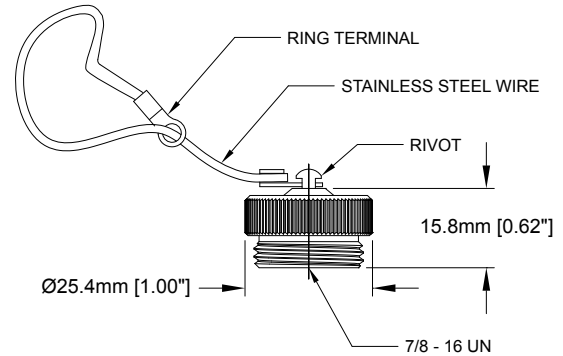

FIG 20: Female, Dustcap, External Threads



All Dimensions in: mm [inch]

This page intentionally left blank.

Ethernet M12

The **Ethernet M12** product line is a Cat 5e cable available in 24AWG/2 pair, in both M12 and RJ45 combinations, TPE jacketing along with a High Flex option. This jacket material is resistant to abrasion, crush and chemical influences, making it suitable for use in conveyors, sorting, automated storage/retrieval, packaging, overhead transport, palletizing, or your specific application requirements.

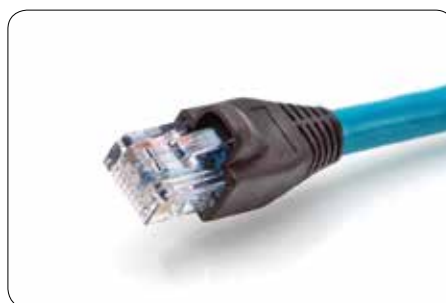



Ethernet M12

Specifications

| | | | |
|---------------------|---|------------|---------------------------------|
| Temperature Range | -25°C to +75°C | Coding | D-Coded (M12 Plugs/Receptacles) |
| Molded Body/Housing | PUR, Black, Nickel-plated over Copper Alloy | Protection | IP67 |
| Contacts | Brass, Gold over Nickel-plating | Coupling | Brass, Nickel-plated |
| Inserts | UL Approved Nylon 6/6 (Plugs/Receptacles) Clear Polycarbonate (RJ45) | Approvals | UL 1863, c(UL) CAN/CSA-C22.2 |

| | 4 Pos, Male, M12, Plug | 4 Pos, Female, M12, Receptacle | 8 Pos, RJ45, Plug |
|-----------------------|--|--------------------------------|-------------------|
| Face Views | | | |
| Cable Characteristics | CAT 5E, 4 wire/2 pair, unshielded 24AWG (7x32) stranded wires, patch, FT-4, sunlight and oil resistant, RoHS, Jacket TPE | | |



| Plug - Description | Part Number | |
|---|-------------|--|
| RJ45 to RJ45 Male, Blue (See FIG 1, Pg 104) | P29932-Mxxx | |
| RJ45 to RJ45 Male, Teal (See FIG 2, Pg 104) | P29933-Mxxx | |
| Ethernet M12, Male to Male, Blue (See FIG 3, Pg 104) | P29934-Mxxx | |
| Ethernet M12, Male to Male, Teal (See FIG 4, Pg 104) | P29935-Mxxx | |
| Ethernet M12, Male to Male, Orange (See FIG 5, Pg 104) | P29936-Mxxx | |

| Receptacle - Description | Part Number | |
|---|-------------|--|
| Ethernet M12, Female to RJ45, Blue (See FIG 6, Pg 105) | P29930-Mxxx | |
| Ethernet M12, Female to Female, Orange (See FIG 7, Pg 105) | P29931-Mxxx | |

Dimensional Drawings

Mxxx = length in meters

FIG 1: P29932-Mxxx, RJ45 to RJ45, Male, Blue

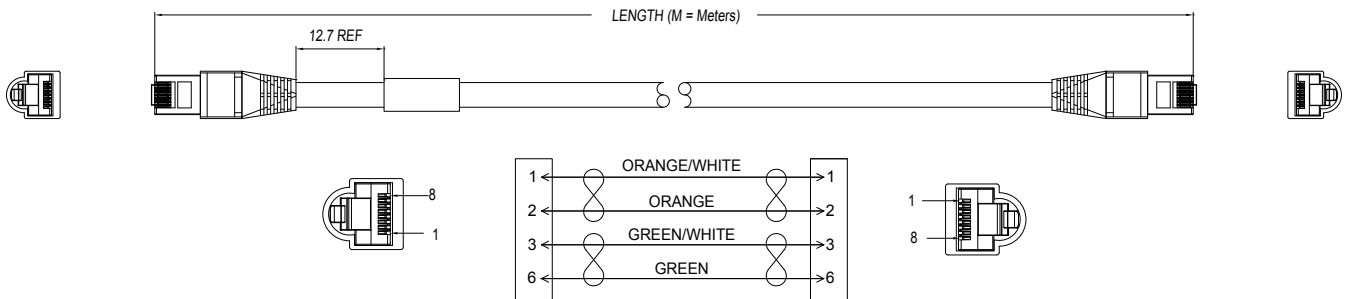

FIG 2: P29933-Mxxx, RJ45 to RJ45, Male, Teal

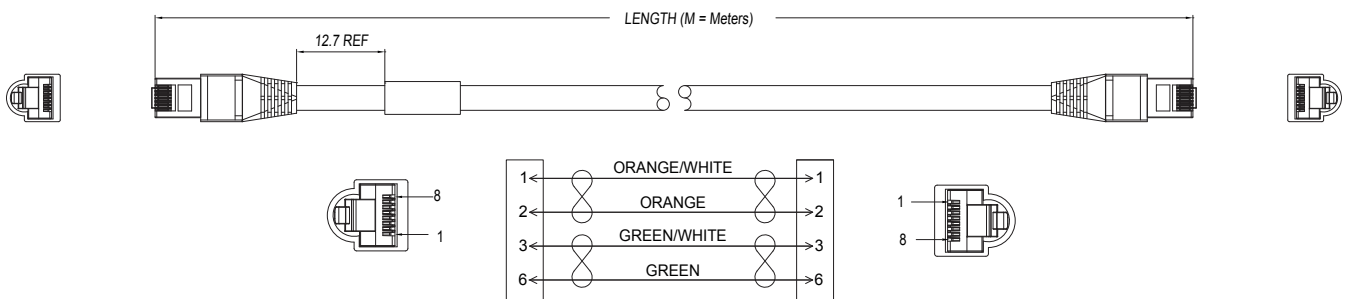

FIG 3: P29934-Mxxx, Ethernet M12, Male to Male, Plug, Blue

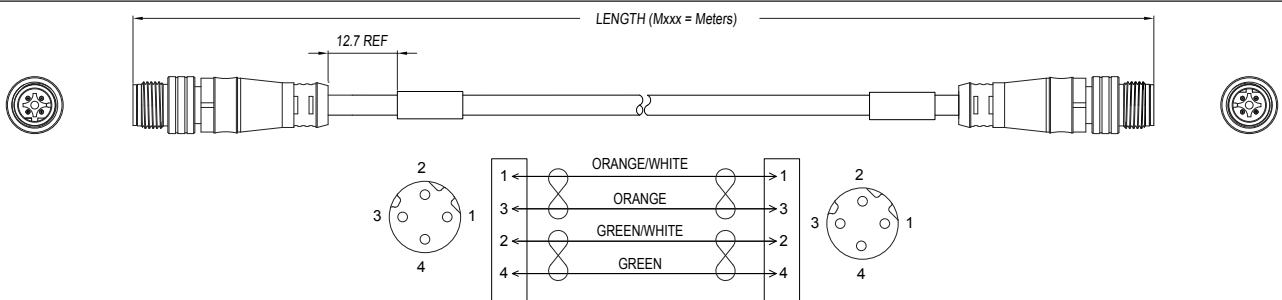
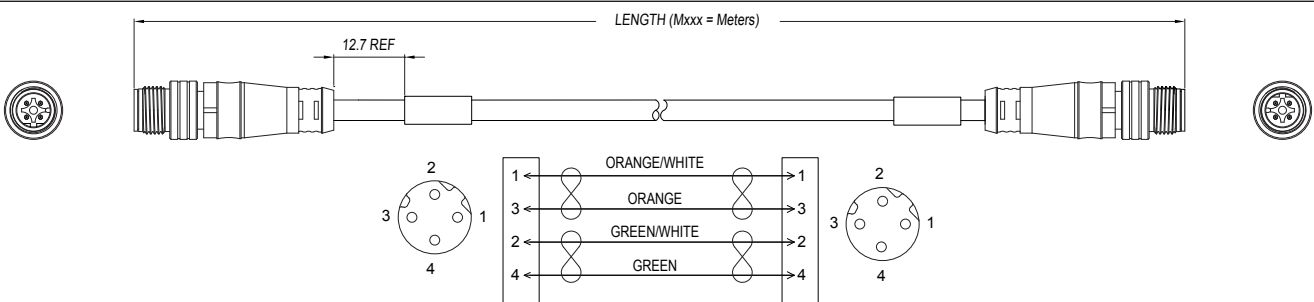

FIG 4: P29935-Mxxx, Ethernet M12, Male to Male, Plug, Teal



All Dimensions in: mm [inch]

Ethernet M12



Dimensional Drawings

Mxxx = length in meters

FIG 5: P29936-Mxxx, Ethernet M12, Male to Male, Plug, Orange

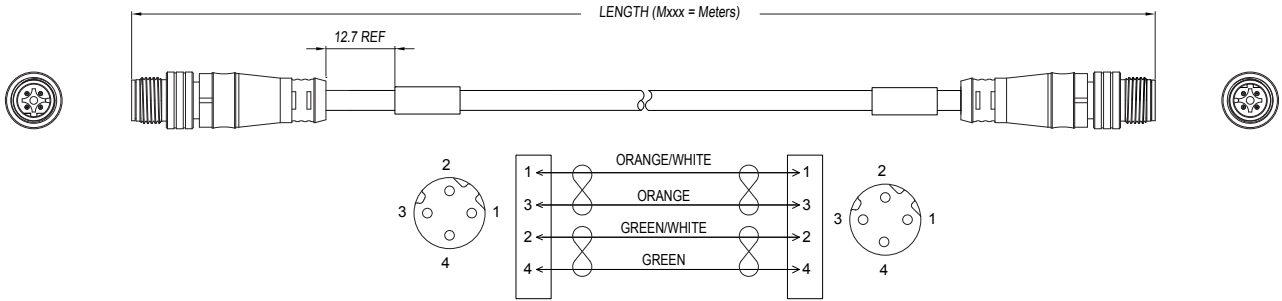

FIG 6: P29930-Mxxx, Ethernet M12, Female Receptacle to RJ45, Blue

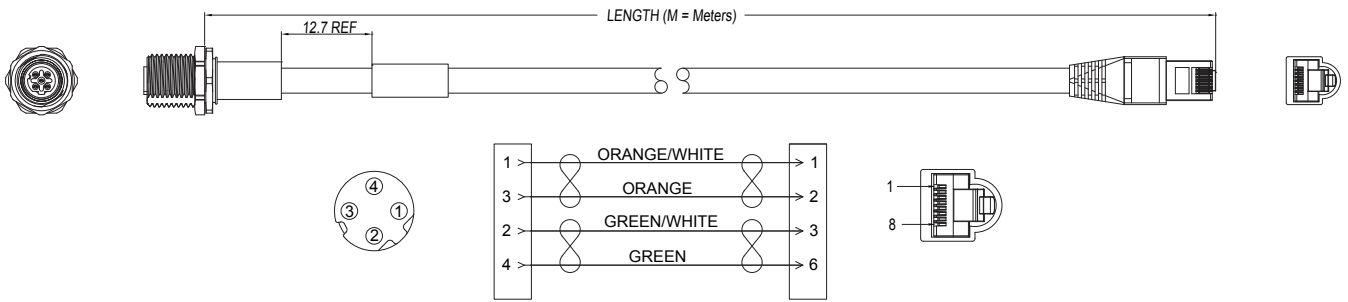
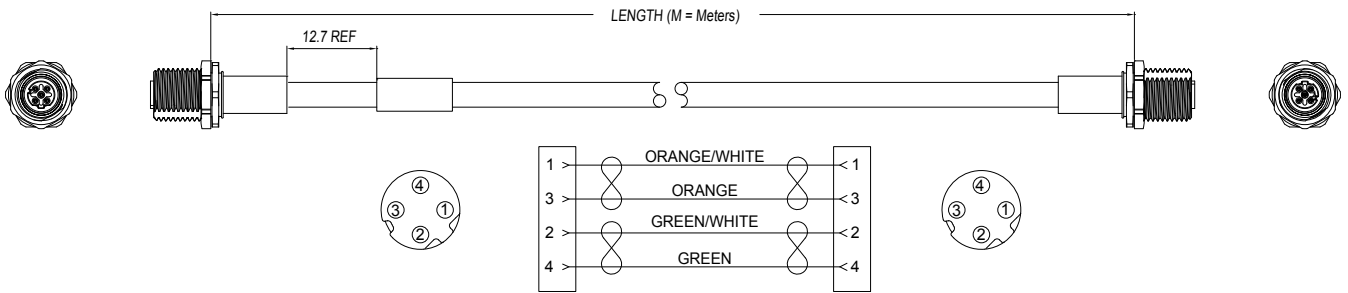

FIG 7: P29931-Mxxx, Ethernet M12, Female to Female, Receptacle, Orange



Part Number Index

| | | | | | |
|---------------------|----|---------------------|----|---------------------|----|
| 10-54938..... | 90 | MC57A4BD02Mxxx..... | 97 | MN51PD01Mxxx..... | 97 |
| 10-80249..... | 38 | MC57AC05Mxxx..... | 93 | MN51PD02Mxxx..... | 97 |
| 34-80289..... | 38 | MC57AC09Mxxx..... | 93 | MN51PW02Mxxx..... | 89 |
| MC31PW03Mxxx..... | 93 | MC57AD02Mxxx..... | 97 | MN52PW02Mxxx..... | 89 |
| MC34AC05Mxxx..... | 93 | MC57B4AC05Mxxx..... | 93 | MN53AC01Mxxx..... | 89 |
| MC34BC05Mxxx..... | 93 | MC57B4AC09Mxxx..... | 93 | MN53BC01Mxxx..... | 89 |
| MC34PW03Mxxx..... | 93 | MC57B4AD02Mxxx..... | 97 | MN54AC01Mxxx..... | 89 |
| MC37A4AC05Mxxx..... | 93 | MC57B4BC05Mxxx..... | 93 | MN54AD01Mxxx..... | 97 |
| MC37A4BC05Mxxx..... | 93 | MC57B4BC09Mxxx..... | 93 | MN54AD02Mxxx..... | 97 |
| MC37AC05Mxxx..... | 93 | MC57B4BD02Mxxx..... | 97 | MN54BC01Mxxx..... | 89 |
| MC37B4AC05Mxxx..... | 93 | MC57BC05Mxxx..... | 93 | MN54BD01Mxxx..... | 97 |
| MC37B4BC05Mxxx..... | 93 | MC57BC09Mxxx..... | 93 | MN54BD02Mxxx..... | 97 |
| MC37BC05Mxxx..... | 93 | MC57BD02Mxxx..... | 97 | MN54PD01Mxxx..... | 97 |
| MC41PW03Mxxx..... | 93 | MN21PW02Mxxx..... | 89 | MN54PD02Mxxx..... | 97 |
| MC44AC05Mxxx..... | 93 | MN22PW02Mxxx..... | 89 | MN54PW02Mxxx..... | 89 |
| MC44AC09Mxxx..... | 93 | MN23AC01Mxxx..... | 89 | MN57A4AC01Mxxx..... | 89 |
| MC44BC05Mxxx..... | 93 | MN23BC01Mxxx..... | 89 | MN57A4AD01Mxx..... | 97 |
| MC44BC09Mxxx..... | 93 | MN24AC01Mxxx..... | 89 | MN57A4AD02Mxx..... | 97 |
| MC44PW03Mxxx..... | 93 | MN24BC01Mxxx..... | 89 | MN57A4BC01Mxxx..... | 89 |
| MC47A4AC05Mxxx..... | 93 | MN24PW02Mxxx..... | 89 | MN57A4BD01Mxx..... | 97 |
| MC47A4AC09Mxxx..... | 93 | MN27A4AC01Mxxx..... | 89 | MN57A4BD02Mxx..... | 97 |
| MC47A4BC05Mxxx..... | 93 | MN27A4BC01Mxxx..... | 89 | MN57AD01Mxxx..... | 97 |
| MC47A4BC09Mxxx..... | 93 | MN27B4AC01Mxxx..... | 89 | MN57AD02Mxxx..... | 97 |
| MC47AC05Mxxx..... | 93 | MN27B4BC01Mxxx..... | 89 | MN57B4AC01Mxxx..... | 89 |
| MC47AC09Mxxx..... | 93 | MN31PW02Mxxx..... | 89 | MN57B4AD01Mxxx..... | 97 |
| MC47B4AC05Mxxx..... | 93 | MN32PW02Mxxx..... | 89 | MN57B4AD02Mxxx..... | 97 |
| MC47B4AC09Mxxx..... | 93 | MN33AC01Mxxx..... | 89 | MN57B4BC01Mxxx..... | 89 |
| MC47B4BC05Mxxx..... | 93 | MN33BC01Mxxx..... | 89 | MN57B4BD01Mxxx..... | 97 |
| MC47B4BC09Mxxx..... | 93 | MN34AC01Mxxx..... | 89 | MN57B4BD02Mxxx..... | 97 |
| MC47BC05Mxxx..... | 93 | MN34BC01Mxxx..... | 89 | MN57BD01Mxxx..... | 97 |
| MC47BC09Mxxx..... | 93 | MN34PW02Mxxx..... | 89 | MN57BD02Mxxx..... | 97 |
| MC51PD02Mxxx..... | 97 | MN37A4AC01Mxxx..... | 89 | MN61PW02Mxxx..... | 89 |
| MC51PW03Mxxx..... | 93 | MN37A4BC01Mxxx..... | 89 | MN62PW02Mxxx..... | 89 |
| MC54AC05Mxxx..... | 93 | MN37B4AC01Mxxx..... | 89 | MN63AC01Mxxx..... | 89 |
| MC54AC09Mxxx..... | 93 | MN37B4BC01Mxxx..... | 89 | MN63BC01Mxxx..... | 89 |
| MC54AD02Mxxx..... | 97 | MN41PW02Mxxx..... | 89 | MN64AC01Mxxx..... | 89 |
| MC54BC05Mxxx..... | 93 | MN42PW02Mxxx..... | 89 | MN64BC01Mxxx..... | 89 |
| MC54BC09Mxxx..... | 93 | MN43AC01Mxxx..... | 89 | MN64PW02Mxxx..... | 89 |
| MC54BD02Mxxx..... | 97 | MN43BC01Mxxx..... | 89 | MN67A4AC01Mxxx..... | 89 |
| MC54PD02Mxxx..... | 97 | MN44AC01Mxxx..... | 89 | MN67A4BC01Mxxx..... | 89 |
| MC54PW03Mxxx..... | 93 | MN44BC01Mxxx..... | 89 | MN67B4AC01Mxxx..... | 89 |
| MC57A4AC05Mxxx..... | 93 | MN44PW02Mxxx..... | 89 | MN67B4BC01Mxxx..... | 89 |
| MC57A4AC09Mxxx..... | 93 | MN47A4AC01Mxxx..... | 89 | MN651PW02-Mxxx..... | 85 |
| MC57A4AD02Mxxx..... | 97 | MN47A4BC01Mxxx..... | 89 | MN654AC07-Mxxx..... | 85 |
| MC57A4BC05Mxxx..... | 93 | MN47B4AC01Mxxx..... | 89 | MN654BC07-Mxxx..... | 85 |
| MC57A4BC09Mxxx..... | 93 | MN47B4BC01Mxxx..... | 89 | MN654PW02-Mxxx..... | 85 |

Part Number Index

| | | | | | |
|-----------------------|----|------------------|----|------------------|-----|
| MN657A4AC07-Mxxx..... | 85 | P28974..... | 19 | P29042..... | 19 |
| MN657A4BC07-Mxxx..... | 85 | P28976-Mxxx..... | 17 | P29043..... | 19 |
| MN657AC07-Mxxx..... | 85 | P28977-Mxxx..... | 17 | P29044..... | 19 |
| MN657B4AC07-Mxxx..... | 85 | P28978-Mxxx..... | 18 | P29044..... | 29 |
| MN657B4BC07-Mxxx..... | 85 | P28979-Mxxx..... | 18 | P29044..... | 86 |
| MN657BC07-Mxxx..... | 85 | P28984-Mxxx..... | 17 | P29044..... | 90 |
| P27779..... | 51 | P28985-Mxxx..... | 17 | P29044..... | 98 |
| P27784-Mxxx..... | 50 | P28986-Mxxx..... | 18 | P29045..... | 19 |
| P27785-Mxxx..... | 50 | P28987-Mxxx..... | 18 | P29045..... | 29 |
| P27786-Mxxx..... | 50 | P28992-Mxxx..... | 16 | P29045..... | 86 |
| P27787-Mxxx..... | 50 | P28993-Mxxx..... | 16 | P29045..... | 90 |
| P27790-Mxxx..... | 50 | P28996-Mxxx..... | 17 | P29045..... | 98 |
| P27791-Mxxx..... | 50 | P28997-Mxxx..... | 17 | P29057-Mxxx..... | 18 |
| P27792-Mxxx..... | 50 | P29000-Mxxx..... | 16 | P29059-Mxxx..... | 18 |
| P27793-Mxxx..... | 50 | P29001-Mxxx..... | 16 | P29309..... | 90 |
| P27796-Mxxx..... | 50 | P29004-Mxxx..... | 17 | P29310..... | 90 |
| P27797-Mxxx..... | 50 | P29005-Mxxx..... | 17 | P29311..... | 90 |
| P27891..... | 51 | P29008-Mxxx..... | 28 | P29312..... | 98 |
| P28375..... | 51 | P29009-Mxxx..... | 28 | P29313..... | 86 |
| P28559-Mxxx..... | 50 | P29010-Mxxx..... | 28 | P29318..... | 98 |
| P28560-Mxxx..... | 50 | P29011-Mxxx..... | 29 | P29319..... | 98 |
| P28561-Mxxx..... | 50 | P29012-Mxxx..... | 28 | P29325..... | 86 |
| P28562-Mxxx..... | 50 | P29013-Mxxx..... | 28 | P29326..... | 86 |
| P28571-Mxxx..... | 50 | P29014-Mxxx..... | 28 | P29328..... | 86 |
| P28572-Mxxx..... | 50 | P29015-Mxxx..... | 29 | P29329..... | 98 |
| P28573..... | 51 | P29016-Mxxx..... | 27 | P29332..... | 94 |
| P28574..... | 51 | P29017-Mxxx..... | 27 | P29333..... | 94 |
| P28625..... | 51 | P29018-Mxxx..... | 28 | P29334..... | 94 |
| P28810..... | 61 | P29019-Mxxx..... | 28 | P29359-Mxxx..... | 18 |
| P28815..... | 61 | P29020-Mxxx..... | 27 | P29360-Mxxx..... | 18 |
| P28816-Mxxx..... | 60 | P29021-Mxxx..... | 27 | P29361-Mxxx..... | 18 |
| P28817-Mxxx..... | 60 | P29022-Mxxx..... | 28 | P29364..... | 18 |
| P28818-Mxxx..... | 60 | P29023-Mxxx..... | 28 | P29841..... | 42 |
| P28819-Mxxx..... | 60 | P29024-Mxxx..... | 18 | P29844-Mxxx..... | 42 |
| P28820..... | 61 | P29026-Mxxx..... | 18 | P29845..... | 43 |
| P28821..... | 61 | P29028-Mxxx..... | 18 | P29848-Mxxx..... | 42 |
| P28822-Mxxx..... | 60 | P29030-Mxxx..... | 18 | P29850..... | 43 |
| P28823-Mxxx..... | 60 | P29032-Mxxx..... | 18 | P29851..... | 38 |
| P28825..... | 61 | P29034-Mxxx..... | 18 | P29851..... | 43 |
| P28826..... | 61 | P29036-Mxxx..... | 29 | P29855..... | 18 |
| P28827..... | 61 | P29037-Mxxx..... | 29 | P29858..... | 19 |
| P28964..... | 18 | P29038-Mxxx..... | 29 | P29930-Mxxx..... | 103 |
| P28966..... | 18 | P29039-Mxxx..... | 29 | P29931-Mxxx..... | 103 |
| P28968..... | 19 | P29040..... | 19 | P29932-Mxxx..... | 103 |
| P28970..... | 19 | P29041..... | 19 | P29933-Mxxx..... | 103 |
| P28972..... | 19 | P29041..... | 29 | P29934-Mxxx..... | 103 |

Part Number Index

| | | | | | |
|------------------|-----|------------------|----|-------------|----|
| P29935-Mxxx | 103 | P30672-Mxxx | 36 | P30862 | 18 |
| P29936-Mxxx | 103 | P30706-Mxxx | 80 | P30863 | 19 |
| P29950-Mxxx | 42 | P30707-Mxxx | 80 | P30864 | 18 |
| P29954-Mxxx | 42 | P30708-Mxxx | 80 | P30865 | 19 |
| P30066-Mxxx | 42 | P30709-Mxxx | 80 | P30866 | 18 |
| P30141 | 37 | P30710-Mxxx | 72 | P30867 | 19 |
| P30142-Mxxx | 37 | P30711-Exxx/Mxxx | 72 | P30868 | 19 |
| P30143-Mxxx | 37 | P30712-Mxxx | 72 | P30869 | 18 |
| P30146-Mxxx | 37 | P30713-Mxxx | 72 | P30870 | 19 |
| P30147-Mxxx | 37 | P30715 | 37 | P30871 | 19 |
| P30163-Mxxx | 37 | P30716 | 18 | P30881-Mxxx | 17 |
| P30164 | 38 | P30717 | 19 | P30882-Mxxx | 16 |
| P30165-Mxxx | 76 | P30727-Mxxx | 29 | P30883-Mxxx | 16 |
| P30166-Exxx/Hxxx | 77 | P30746-Mxxx | 29 | P30884-Mxxx | 17 |
| P30167-Exxx/Hxxx | 77 | P30748-Mxxx | 17 | P30885-Mxxx | 16 |
| P30189-Mxxx | 37 | P30749-Mxxx | 17 | P30886-Mxxx | 16 |
| P30237-Mxxx | 36 | P30750-Mxxx | 17 | P30887-Mxxx | 17 |
| P30238-Mxxx | 36 | P30751-Mxxx | 17 | P30888-Mxxx | 17 |
| P30239-Mxxx | 36 | P30752-Mxxx | 16 | P30889-Mxxx | 28 |
| P30240-Mxxx | 36 | P30753-Mxxx | 16 | P30890-Mxxx | 27 |
| P30241-Mxxx | 36 | P30754-Mxxx | 16 | P30891-Mxxx | 27 |
| P30242-Mxxx | 36 | P30755-Mxxx | 16 | P30892-Mxxx | 28 |
| P30253-Mxxx | 17 | P30756-Mxxx | 28 | P30893-Mxxx | 27 |
| P30254-Mxxx | 28 | P30757-Mxxx | 28 | P30894-Mxxx | 27 |
| P30256-Mxxx | 37 | P30758-Mxxx | 28 | P30895-Mxxx | 28 |
| P30257-Mxxx | 37 | P30759-Mxxx | 28 | P30896-Mxxx | 28 |
| P30412-Mxxx | 80 | P30760-Mxxx | 27 | P30965 | 86 |
| P30510 | 38 | P30761-Mxxx | 27 | P31000 | 18 |
| P30510 | 43 | P30762-Mxxx | 27 | P31001 | 18 |
| P30538-Mxxx | 72 | P30763-Mxxx | 27 | P31002 | 18 |
| P30539-Exxx/Hxxx | 73 | P30764-Mxxx | 17 | | |
| P30540-Exxx/Hxxx | 73 | P30765-Mxxx | 17 | | |
| P30544-Exxx/Hxxx | 81 | P30766-Mxxx | 17 | | |
| P30545-Exxx/Hxxx | 81 | P30767-Mxxx | 17 | | |
| P30552-Mxxx | 76 | P30768-Mxxx | 16 | | |
| P30553-Mxxx | 76 | P30769-Mxxx | 16 | | |
| P30618-Mxxx | 80 | P30770-Mxxx | 16 | | |
| P30619-Mxxx | 72 | P30771-Mxxx | 16 | | |
| P30648-Mxxx | 76 | P30772-Mxxx | 28 | | |
| P30664-Mxxx | 76 | P30773-Mxxx | 28 | | |
| P30665-Mxxx | 76 | P30774-Mxxx | 28 | | |
| P30667-Mxxx | 37 | P30775-Mxxx | 28 | | |
| P30668-Mxxx | 36 | P30776-Mxxx | 27 | | |
| P30669-Mxxx | 36 | P30777-Mxxx | 27 | | |
| P30670-Mxxx | 37 | P30778-Mxxx | 27 | | |
| P30671-Mxxx | 36 | P30779-Mxxx | 27 | | |

www.amphenol-sine.com

USA

Amphenol Sine Systems
44724 Morley Drive
Clinton Township, MI 48036
Toll-Free: 1-800-394-7732
Fax: 1-586-465-1216
Email: csr@amphenol-sine.com
www.amphenol-sine.com

Germany

Amphenol Tuchel GmbH
August-Haeusser-Strasse 10
Heilbronn, Germany 74080
Phone: 49(0)-7131-929-0
Fax: 49(0)-7131-929-486
Email: info@amphenol.de
www.amphenol.de

China

Amphenol Sine Systems
Building 21, 1st Liao Keng Industrial Zone,
Shi Yan Street, Bao An District
Shenzhen, China 518180
Tel: 86-755-8173-8000 ext. 8098
Fax: 86-755-8173-8180
www.amphenol-sine.com.cn

USA

Amphenol Corporation
Corporate Headquarters
358 Hall Ave
Wallingford Ct 06492
Phone: (877) 267-4366
www.amphenol.com

Mexico

Prolongacion Reforma 61-6 B2
Col. Paseo de las Lomas
C.P. 01330 Mexico DF, Mexico
Phone: 52-55-5258-9984
Fax: 52-55-5081-6890
Email: info@amphenolmexico.com
www.amphenolmexico.com

Argentina

Amphenol ARGENTINA
Avenida Callao 930
2nd floor Office B Plaza
C1023AAP Buenos Aires, Argentina
Phone: 54-11-4815-6886
Fax: 54-11-4814-5779
Email: info@amphenol.com.ar
amphenol.com.ar

Brazil

Amphenol do Brasil Ltda
Rua Diogo Moreira, 132
20 Andar, Rooms 2001-2-3
CEP 05423-101
Sao Paulo- SP, Brazil
Phone: 55-11-3815-1003
Fax: 55-11-3815-1629
www.amphenol.com.br

France

Amphenol SOCAPEX
948, Promenade de l'Arve - BP 29
74311 Thyez CEDEX, France
Phone: 33(0)4-50-89-28-40
Fax: 33(0)4-50-96-29-75
www.amphenol-socapex.com

United Kingdom

Amphenol LIMITED
Thanet Way, Whitstable
Kent CT5 3JF, United Kingdom
Phone: 44-1-227-773200
Fax: 44-1-227-276571
www.amphenol.co.uk

Australia

Amphenol AUSTRALIA PTY LIMITED
22 Industry Boulevard
Carrum Downs VIC 3201
Australia
Phone: +61-3-8796-8888
Fax: +61-3-8796-8801
www.amphenol.com.au

Turkey

Amphenol International Ltd Turkey
Sun Plaza Kat. 15
Maslak Mah. Bilim Sok. No. 5
34398 Sisli / Istanbul – Turkey
Tel: + 90 212 367.92.20
Fax: + 90 212 367.92.21
www.amphenol.com.tr

South Africa

Amphenol International Ltd
South Africa
30 Impala Road
2196 Sandton, Chislehurst
South Africa
Phone: 27-11-783-9517
Fax: 27-11-783-9519
Email: sales@amphenolafrica.com
www.amphenol.com.za

India

Amphenol INTERCONNECT INDIA PVT LTD
105 Bhosari Industrial Area
Pune 411 026, India
Phone: +91 20 67360304
Fax: +91 20 67360321
www.amphenol-in.com

Korea

Amphenol DAESHIN
558. Songnae-2 Dong, SoSa-Gu
Bucheon City, Gyeonggi-do,
Korea 422-818
Phone: 81-32-610-3800
Fax: 81-32-673-2507
Email: info@amphenol.co.kr
www.amphenol.co.kr

Japan

Amphenol JAPAN
471-1, Deba, Ritto-city
shiga 520-3041, Japan
Phone: 81-77-553-8501
Fax: 81-77-551-2200
www.amphenol.co.jp

Russia

Amphenol RUSSIA
8 Yaroslavskaja Street
129164 Moscow, Russia
Phone: 7495-937-6341
Fax: 7495-937-6319
www.amphenol.ru

X-ON Electronics

Largest Supplier of Electrical and Electronic Components

Click to view similar products for [Sensor Cables / Actuator Cables](#) category:

Click to view products by [Amphenol](#) manufacturer:

Other Similar products are found below :

[60963](#) [60964](#) [M83513/19-F01CP](#) [703000D02F2002](#) [703001D02F0602](#) [703001D02F300](#) [704000D02F120](#) [773032K02F030](#) [802027107404-1](#)
[802027213811-1](#) [804001A09M150](#) [805001A09M0502](#) [84914-0235](#) [84914-0237](#) [885030A09M020](#) [8R4J30E03C3003](#) [1200651332](#)
[1200651713](#) [1200660844](#) [1200660845](#) [1200661173](#) [1200680071](#) [1200720053](#) [1200720081](#) [1200720099](#) [1200720217](#) [1200800231](#)
[1200860125](#) [1200870123](#) [1200980102](#) [1200650267](#) [1200650298](#) [1200660183](#) [1200660782](#) [1200660849](#) [1200661295](#) [1200661297](#)
[1200661342](#) [1200661343](#) [1200670080](#) [1200670220](#) [1200680331](#) [1200720252](#) [1200730184](#) [1200860344](#) [1200870359](#) [1200870643](#)
[1200980008](#) [1200980031](#) [1210502211](#)