

# Factory Automation

## Distributed Power & Control

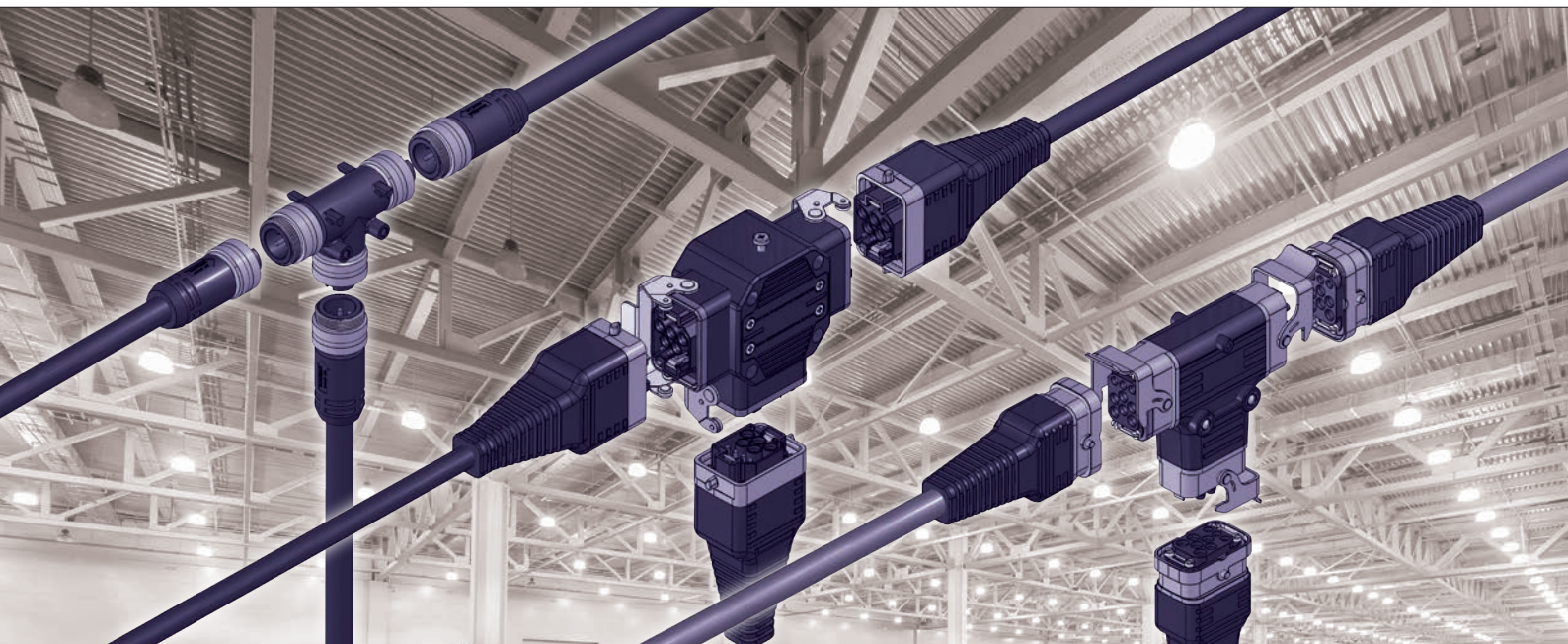

PowerBOSSlite™ M35 (1 $\frac{3}{8}$ " ), PowerBOSSlite™ M22 ( $\frac{7}{8}$ " ), PowerBOSS™ M40 featuring Checkmate™  
PowerBOSS™ M40, PowerBOSS™, ControlBOSS™, VersaBOSS™ - FC Hybrid, MC, Powerflex  
ControlPower, miniBOSS™ M22 ( $\frac{7}{8}$ " ), microBOSS™ M12 ( $\frac{1}{2}$ " ), DeviceNet, Ethernet M12



# Table of Contents

We Are Amphenol .....	1
Standard Products. Custom Solutions.....	2
Product Overviews.....	3
Why and Where? .....	7
Installation Considerations .....	9
Architectural Layouts.....	11
PowerBOSSlite™ M35 (1 <sup>3</sup> / <sub>8</sub> " ) .....	14
PowerBOSSlite™ M22 (7/ <sub>8</sub> " ) .....	26
PowerBOSS™ M40 featuring Checkmate™ .....	32
PowerBOSS™ M40.....	42
PowerBOSS™ .....	46
ControlBOSS™ .....	58
VersaBOSS™ - FC Hybrid .....	72
VersaBOSS™ - MC .....	76
VersaBOSS™ - Powerflex .....	80
ControlPower.....	84
miniBOSS™ M22 (7/ <sub>8</sub> " ) .....	88
microBOSS™ M12 (1/ <sub>2</sub> " ) .....	92
DeviceNet.....	96
Ethernet.....	102
Index.....	106



# We are Amphenol.

## Global Interconnect Solution Supplier

For over 80 years Amphenol has enjoyed success as the interconnection technology provider of choice to industry leading companies around the world. Our organization works with leading manufacturers across a wide range of applications - including Energy Generation & Distribution, Transportation, Heavy Equipment, Factory Automation, Wireless Outdoor, Information Technology and Data Communications Equipment, Mobile Devices, Mobile Networks, Broadband Communication, Military and Commercial Aerospace, Industrial, Automotive and Chip Card Readers - enabling smarter, faster and better technologies to connect products to customer solutions.

Our engineers design innovative combinations of industry standard connectors and application specific shielding components to create assembly systems that set the standards for performance, reliability, and cost effectiveness. Our engineering, materials, and manufacturing organizations meet the high standards imposed by ISO 9001:2008 as well as many customer specific quality systems. Our performance has earned us ship to stock and world class performance awards from many major OEMs.

We are one of the largest interconnect solution suppliers in the world and supply a wide range of product solutions globally. The industrial market footprint of Amphenol covers more than 30 countries.



# Standard products. Custom solutions.

Our Factory Automation - Distributed Power and Control product lines, which include PowerBOSSlite™ M22 and M35, PowerBOSS™ M40 and M40 featuring Checkmate™ Technology, PowerBOSS™, ControlBOSS™, miniBOSS™ M22, microBOSS™ M12, DeviceNet, ControlPower, Ethernet and our VersaBOSS™ Series, have key placement in most areas of Automation. Based on our proven build-quality, high-performance capabilities and comparable mating to other existing standard products industry-wide, our Factory Automation products are reliable alternatives for you.

We can custom design, engineer and manufacture cable assemblies to your exact customer specifications and produce large or small quantities, all to the highest standards, delivered on-time and in-specification, all with a significant cost-savings over the competition.

By combining locally-based Program Management & Engineering, along with the associated cost advantages derived from manufacturing in our low-cost production centers in North America and Asia, our Team will work with you to design the most cost-efficient and reliable interconnect system available.



# Product Overviews

The products in this catalog were developed in response to the need for a robust, streamlined and scalable product for use in most robotic and material handling systems, such as: conveyors, sorting, automated storage and retrieval, packaging, overhead transport, palletizing and any other options imaginable. If you have a custom project and are in need of more specialized connectors or cable assemblies, please contact us directly at +1 800 394 7732 and we will direct you to the appropriate Program Manager for your needs.



### PowerBOSSlite™ M35 (1 3/8") Pg. 14 3 & 4 positions available

- 30A Max Current; 600V; 10AWG
- High-performance, cost-effective
- Single and Dual-rated cable options
- Comparable with existing standard products industry-wide
- Select parts available in Black and Red options



### PowerBOSSlite™ M22 (7/8") Pg. 26 3 & 4 positions available

- 15A Max Current; 600V; 14AWG
- High-performance, cost-effective
- Single and Dual-rated cable options
- Comparable with existing standard products industry-wide
- Select parts available in Black and Red options



### PowerBOSS™ M40 featuring **CheckMate™** Pg. 32 6 position

Features Checkmate™ Advanced Interconnect System

- Color-coded, 1/4-turn locking mechanism
- Safety Sleeve and Clip Assembly
- \*8AWG: 32A (Power), 5A (Signal) Max Current; 600V
- 10AWG: 25A (Power), 5A (Signal) Max Current; 600V
- High-performance, cost-effective



\*The Industrial@Amphenol products found within this section are UL 2237 Listed for the amperage ratings provided. However, for higher amperage requirements with governances outside of this specific UL listing, please consult your salesperson as higher amperage values may be applicable.

## Product Overviews, cont.



### PowerBOSS™ M40 Pg. 42 6 position

- \*32A (Power) 5A (Signal) Max Current; 600V
- High-performance, cost-effective
- Comparable with existing standard products industry-wide



\*The Industrial@Amphenol products found within this section are UL 2237 Listed for the amperage ratings provided. However, for higher amperage requirements with governances outside of this specific UL listing, please consult your salesperson as higher amperage values may be applicable.



### PowerBOSS™ Pg. 46 9 position

- 40A Max Current; 600V; 8-12AWG
- 4+PE (Power), 4 (Signal)
- Contains a single channel safety relay to de-energize the cable to prevent arch flash upon disconnection



### ControlBOSS™ Pg. 58 9 position

- 14-18AWG
- 6+PE (Power), 3 (Signal)
- 15A (Power), 2A (Signal)
- Combination of DeviceNet + 2 Add'l Circuits



### ControlPower Pg. 84 6 position/5 Used

- 10A Max Current; 600V; 16AWG
- High-performance, cost-effective
- Comparable with existing standard products industry-wide
- Select parts available in Black and Red options



## Product Overviews, cont.

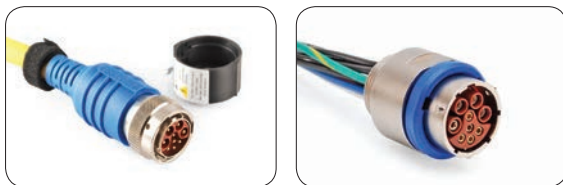

### VersaBOSS™ FC Hybrid Pg. 72

9 position

- 20A (Power), 5A (Signal) Max Current; 16-18AWG
- 600V (Power), 30V (Signal) Max Voltage, 16-18AWG
- High-performance, cost-effective
- Available in High-Flex/TPE Yellow and Static/PVC Black Cable
- Blue overmold



### VersaBOSS™ MC Pg. 76

9 position

- 20A (Power), 5A (Signal) Max Current; 13-18AWG
- 600V (Power), 30V (Signal) Max Voltage; 13-18AWG
- High-performance, cost-effective
- Available in High-Flex/TPE Yellow and Static/PVC Black Cable
- Black overmold

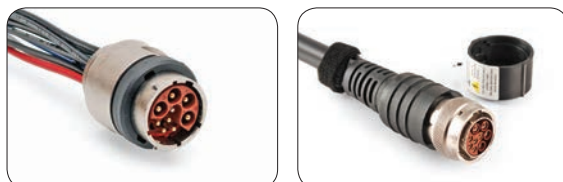

### VersaBOSS™ Powerflex Pg. 80

9 position

- 20A (Power), 5A (Signal) Max Current; 12-18AWG
- 600V (Power), 30V (Signal) Max Voltage; 12-18AWG
- High-performance, cost-effective
- Available in High-Flex/TPE Yellow and Static/PVC Black Cable
- Yellow overmold



### miniBOSS™ M22 (7/8") Pg. 88

2, 3, 4, 5 and 6 positions available

- 13A Max Current; 600V Max Voltage; 16AWG
- Utilizes UL ST00W/CSA Type ST cable
- High Flex TPE jacketed UL Listed TC-ER cable option
- High-performance, cost-effective
- Comparable with existing standard products industry-wide





## Product Overviews, cont.



### microBOSS™ M12 (1/2") Pg. 92

3, 4 and 5 positions available

- 4A Max Current; 300V Max Voltage; 22AWG
- Utilizes both UL AWM-style 2661 and CSA/AWM I/II A/B cable
- Flex and High Flex cable options
- High-performance, cost-effective
- Comparable with existing standard products industry-wide



### DeviceNet Pg. 96

5 position available

- Max Current, per Cable; 300V; 15-24AWG
- Available in Static, Thick and Thin cable
- Utilizes UL Type CL2 or PLTC and CSA AWM I/II A/B FT4 cable
- Flex and High Flex cable options
- High-performance, cost-effective
- Comparable with existing standard products industry-wide



### Ethernet Pg. 102

4 pos. (Plug/Receptacle) and 8 pos. (RJ45) available

- Cat 5e Cable
- 24AWG/2 Pair
- M12 and RJ45 Combinations
- TPE Jacketing/High Flex Options
- High-performance, cost-effective
- Comparable with existing standard products industry-wide



## Why & Where?

### Why Amphenol Modular Pre-Wired Connection Systems for Industrial Power Distribution & Motor Control?

Today's rapidly evolving industrial wiring protocols in conjunction with the demands of cable shielding requirements have dictated the rapid acceleration of "Quick-Connect" topologies within the past decade. Increasingly, designers & integrators of automation and control systems are specifying within their architectures the performance and reliability derived from code-compliant, high quality, factory-molded Amphenol cabling systems.

These streamlined modern connectivity systems accommodate many diverse performance requirements for industrial machinery end users and the electrical contractors which serve them. Previous methodologies which utilized hard-wired or conduit are inherently costly to implement, inflexible, and wrought with complications derived from the inconsistencies of field terminations. Factor in the deployment of field technicians, subsequent debugging, and the accumulative effect of these delays preventing timely commissioning of equipment, in addition to the costs associated with licensed electricians to install them and your bottom line just got a lot thinner.

Amphenol's proven wiring systems offer time savings during both the plant layout and installation phases by simplifying your wiring needs. Engineered for fast, flexible on-site connections without specialized tools, complex cable schematics and a reduced reliance on highly skilled labor allows your system commissioning time to run on budget. Even when your plant-floor requirements change, these modular and scalable systems allow you to rapidly reconfigure to meet your customers' changing demands.

### Greater Flexibility Equals Lower Total Cost of Ownership

- **Rapid Install Due to Scalable Modular Design at Startup**
- **Repeatable System for Expansion or Plant Reconfiguration**
- **Faster Commissioning with Reliable "Plug & Play" Capability Dramatically Reduces Costs**
- **Factory Assembled & Code Compliant System Eliminate Field Wiring Errors & Cable Pullout**
- **Eliminates Traditional Raceways, Conduit & Cable Glands while Increasing Ingress Protection**
- **Quick Disconnects Minimize Downtime from Removal or Replacement of Failed Equipment**
- **Rugged Over-molded Connectors & Feature Crush & Oil Resistant Cables**
- **Cable Topology is designed before Plant Delivery by the Machine Design Engineer**

### Proven Quality

Amphenol prides itself on its consistent quality products. Our designs have been tested in the lab and verified around the world. Each assembly is tested electrically to ensure your systems reliability. Our modular connection architectures feature available options such as crush resistant, pre-wired cord sets with rugged factory molded connectors. Compliant with various code compliances such as NFPA 79-2007 standards. UL2237 PVVA Listed.

## Why & Where?

### Custom Capabilities

To meet a wide variety of application specifications, Amphenol offers the advantage of cordsets with built-to-order, custom capabilities. We offer a complete turnkey solution to meet your application demands. Highly configurable and repeatable wiring topologies can be customized to achieve plant flexibility. These cordsets can be manufactured to customer specifications to include custom mold colors, wiring and environmental protection. Our products provide customers optimum scalability and flexibility while simplifying your electrical requirements with a practical solution that can be tailored to fit individual application specifications, yet still be cost efficient.

### Flexible Power & Control Where YOU Need it.

- Automated Machine Tools
- Overhead Transport
- Distributed Power & Control of Motors
- Palletizing, Packing and Shrink Wrapping
- Automated Assembly
- Airport Baggage Handling
- Material Handling
- Automotive Processing
- Packaging Equipment
- Food and Beverage Processing
- Logistics
- Pharmaceutical Process Equipment
- Automated Storage and Retrieval
- Petrochemical Plants
- Parcel Distribution
- Communication Devices

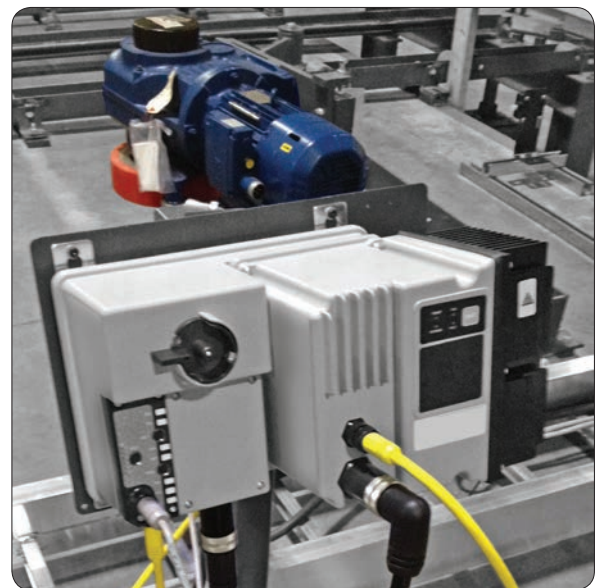

# Installation Considerations

1. Determine the amperage/voltage requirements for your specific application.
2. NEVER disconnect cordset while it is under load
3. Always supply power from the Female connector
4. Protect connectors from damage with closure caps

**Note:** Reference NFPA 79 (Electrical Standards for Industrial Machinery) for required over current protection of conductors and installation guidelines pertaining to industrial machine applications.

**For Temporary Installs:** Cordsets with STOOW ratings allow for installations under the NEC article 400, 'Flexible Cords and Cables'. STOOW cables are more resilient and can be used to connect temporary equipment, such as fans, lights, etc. And can be utilized on flooring where harsher conditions exist, especially when compared to TC only rated cable. STOOW is an Underwriters Laboratories classification meaning the system includes hard-service flexible cord with thermoplastic insulation, in which both the jacket and the conductor insulation are oil-resistant, and the assembly is also moisture and sunlight resistant.

**For Permanent (or Temporary) Installs:** Multiple ratings allow cable assemblies to be used anywhere within the install. TC, ER and MTW ratings allow for usage inside trays/raceways, and STOOW and Open Wiring designated TC cables can be exposed along the structure while maintaining crush/impact resistance of an MC(metal clad) cable.

Cables which achieve a TC-ER have passed stringent crush and impact test, allowing them to be used in "Exposed Runs" (ER) per the installation guidelines of NFPA 79 and/or NEC 336.10(7). These cables do not require cable trays if they are mechanically protected with angles, struts or channels every 1.8m (6'). Are permitted between a cable tray and the utilization equipment or device...secured at intervals not exceeding 1.8m (6'). Permitted to transition between cable trays and utilization equipment or devices for a distance not exceeding 1.8m (6') without continuous support. In addition, these cables also pass UL 1569 effectively eliminating the need for expensive metal requirements which would otherwise be required.

When determining your system requirements and layout, ensure only code compliant practices and wiring methods are deployed. To provide your flexible-wiring implementation with an enhanced level of safety you require, either STOOW/ TC ER or the TC ER only products are regarded as premium cable protection options. However, you may select a TC-ER only cable option versus the dual rated STOOW/ TC-ER from many of the Amphenol PowerBoss products. As a result, these options will provide slightly reduced cable diameters, yielding increased flexibility in addition to an improved cost point.

# Installation Considerations

## Theoretical Horsepower Ratings

**Note:** These tables are for reference only, and are based on 85% motor efficiency and 90% power factor. Please consult the drive/motor manufacturer for specific FLC ratings and temperature deratings. Reference NFPA 79 2007 edition.

Pins	Wire Gauge (AWG) / Amperage (A)	Voltage (V)	Horsepower (hp)
3 (Single Phase 2 Conductors)	10AWG / 30A	230V	7hp
		460V	14hp
		575V	17hp
	12AWG / 25A	230V	5hp
		460V	11hp
		575V	14hp
	14AWG / 18A	230V	4hp
		460V	8hp
		575V	10hp
Pins	Wire Gauge (AWG) / Amperage (A)	Voltage (V)	Horsepower (hp)
4 (Three Phase 3 Conductors)	10AWG / 25A	230V	10hp
		460V	20hp
		575V	25hp
	12AWG / 20A	230V	8hp
		460V	16hp
		575V	20hp
	14AWG / 15A	230V	6hp
		460V	12hp
		575V	15hp

Amphenol's wiring systems can achieve up to 40A, 600V for 8AWG trunk connector. This amperage (A) rating should be applied according to the rules set forth in NEC article 430 for sizing circuits for motor control applications.

## Reference for NFPA 79, UL, cUL, TC and TC-ER

### NFPA 79 - 2007 Compliant

NFPA 79 applies to the electrical equipment used within a wide variety of machines, as well as, groups of machines working together in a coordinated manner. Examples of industrial machinery include, among others: machine tools, injection molding machines, woodworking equipment, assembling machinery, material handling machinery and inspection and testing machines. The scope of NFPA 79 includes all electrical and electronic elements of the machinery operating at 600V or less.

In 2007, the NFPA 79 code underwent significant revisions. The main goal of the revision was to harmonize NFPA 79 with its European counterpart, IEC-60204. This involved reorganizing the NFPA 79 chapter structure to follow IEC-60204 while adopting less restrictive, more progressive requirements without sacrificing the equipment safety.

### Conductor Sizing for Power Circuits

1997 Ed.: Section 15.3(a): Conductors shall be no smaller than 14AWG

2007 Ed.: Section 12.6.1: Conductors shall not be smaller than 14AWG for power circuits unless otherwise permitted in 12.6.1.1 (16 AWG) and 12.6.1.2 (18 AWG).

### Wiring Methods and Practices Regarding Connectors

1997 Ed.: Section: 16.1.4: Conductors and cables shall be run without splices from terminal to terminal.

2007 Ed.: Section 13.1.2.2: Factory-applied connectors, molded onto cables, shall be permitted. Such connectors shall not be considered as splices or joints.

### Wiring Methods and Practices Regarding Exposed Cable

1997 Ed.: Section 16.3.1: Conductors and their connections, external to the control panel, shall be totally enclosed in suitable raceways or enclosures.

2007 Ed.: Section 13.1.5.1: Exposed cables, installed along the structure of the equipment or system or in the chases of the machinery, shall be permitted. Exposed cables shall be installed to closely follow the surface and structural members of the machinery

### UL 2237 (PVVA) Listed - System integrity and Safety Preservation

Simply reset or eliminate the faulty condition and continue system operation. Perfect for applications with a high potential for extreme electrical transients.

### UL/cUL - Underwriters Laboratory, Inc.

UL is the leading organization for electrical safety in the USA. Products approved by UL are marked with a corresponding logo. Products that are labeled 'UL Listed' means that UL has tested and evaluated representative samples of the product to determine they meet UL standards. This type of UL mark is commonly seen on appliances, computer equipment, furnaces, heaters, fuses, electrical panel boards, smoke and carbon monoxide detectors, fire extinguishers, personal flotation devices, bullet resistant glass, and other products. The cUL mark is applied to products intended for the Canadian market. They have been evaluated to Canadian safety requirements, which may differ from U.S. safety standards.

# Architectural Layouts - Traditional

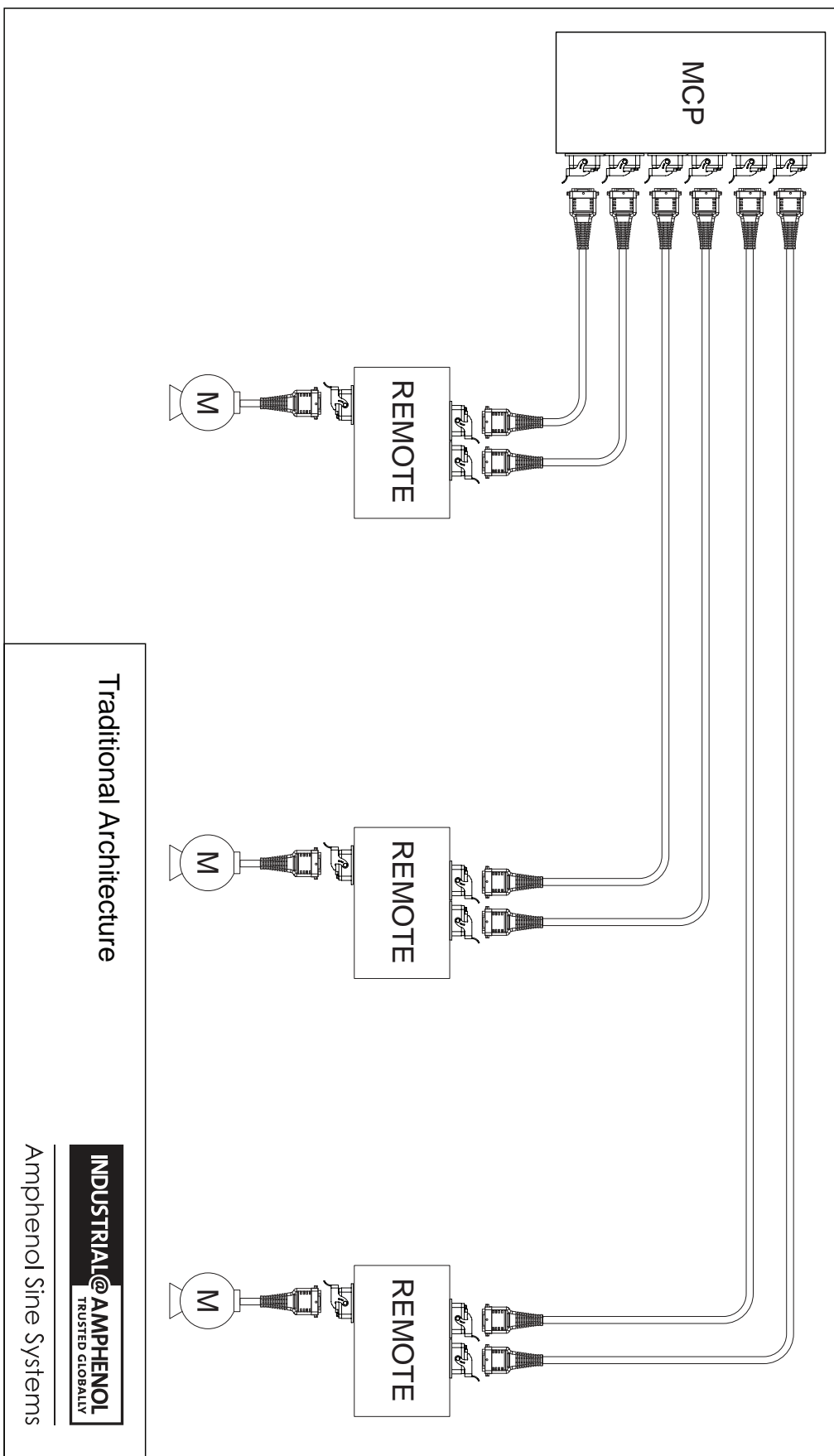

# Architectural Layouts - Power and Control

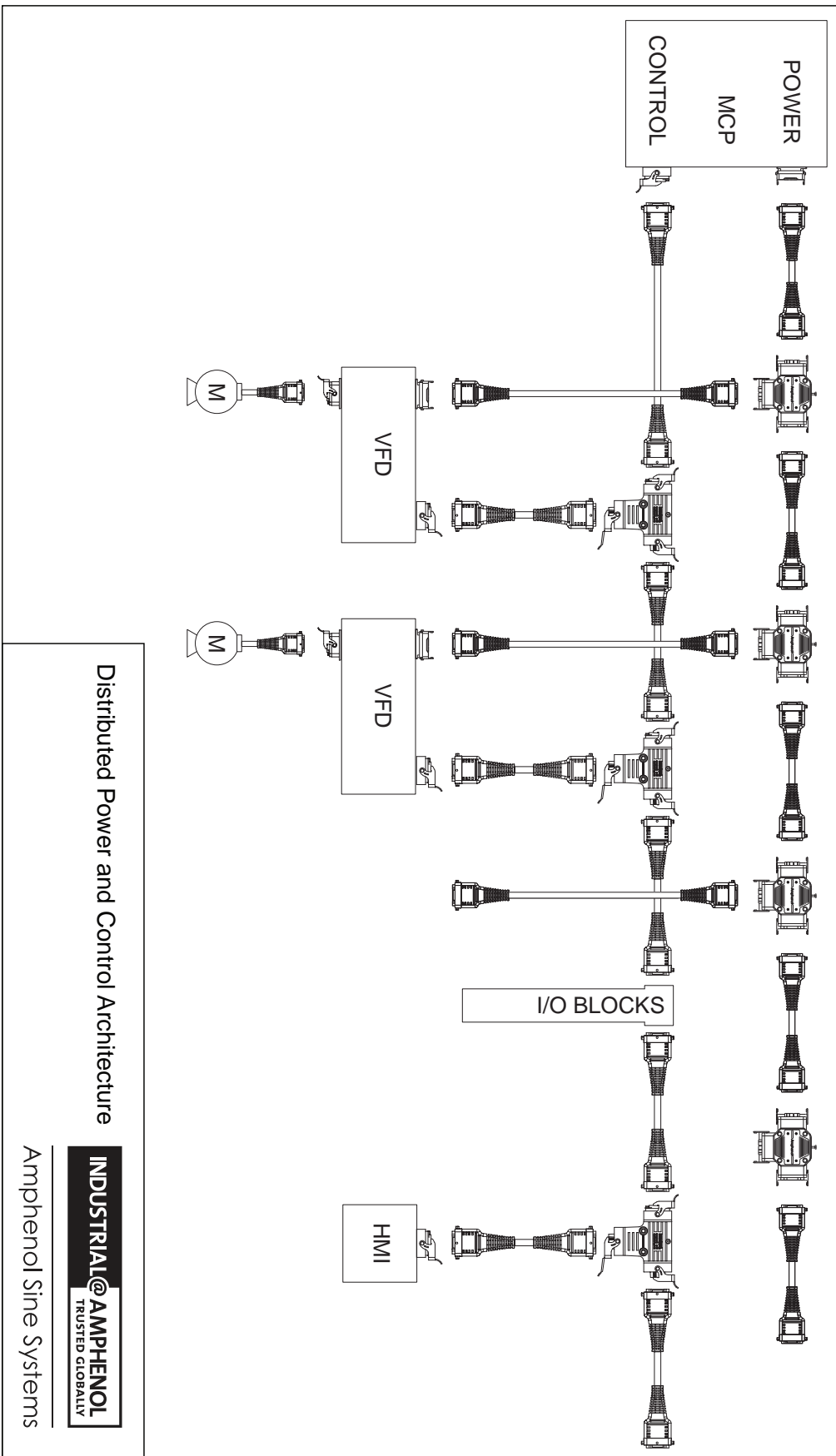

This page intentionally left blank.



# PowerBOSSlite™ M35

Power Distribution System



- Easy 'Plug & Play' Installation • Scalable • Easy to Repeat
- Faster Install & Labor Times • Faster to Market Time • Less Downtime
- Increased Worker Productivity • Elimination of Specialized Tooling
- Reduced Maintenance, Manufacturing and Labor Costs

(This layout includes our VersaBOSS™ product line. Please reference pages 68-84 for product specifics.)



**TEES**, when used with 'Trunk' and 'Drop' connectors provide 'plug & play' daisy-chained connectivity for your devices.



**DUSTCAPS**, in both Male and Female options, provide a convenient, safe way to seal the end of a line, or "stop point".



Color-coded **VersaBOSS™ RECEPTACLES** offer quick-connect interface to the device or cabinet.



Color-coded, crush-resistant, overmolded **VersaBOSS™ CONNECTORS** with standard 3 Power + PE/5 Signal contacts. Allows up to 20A while controlling Signal, Brake or Thermal at 5A.

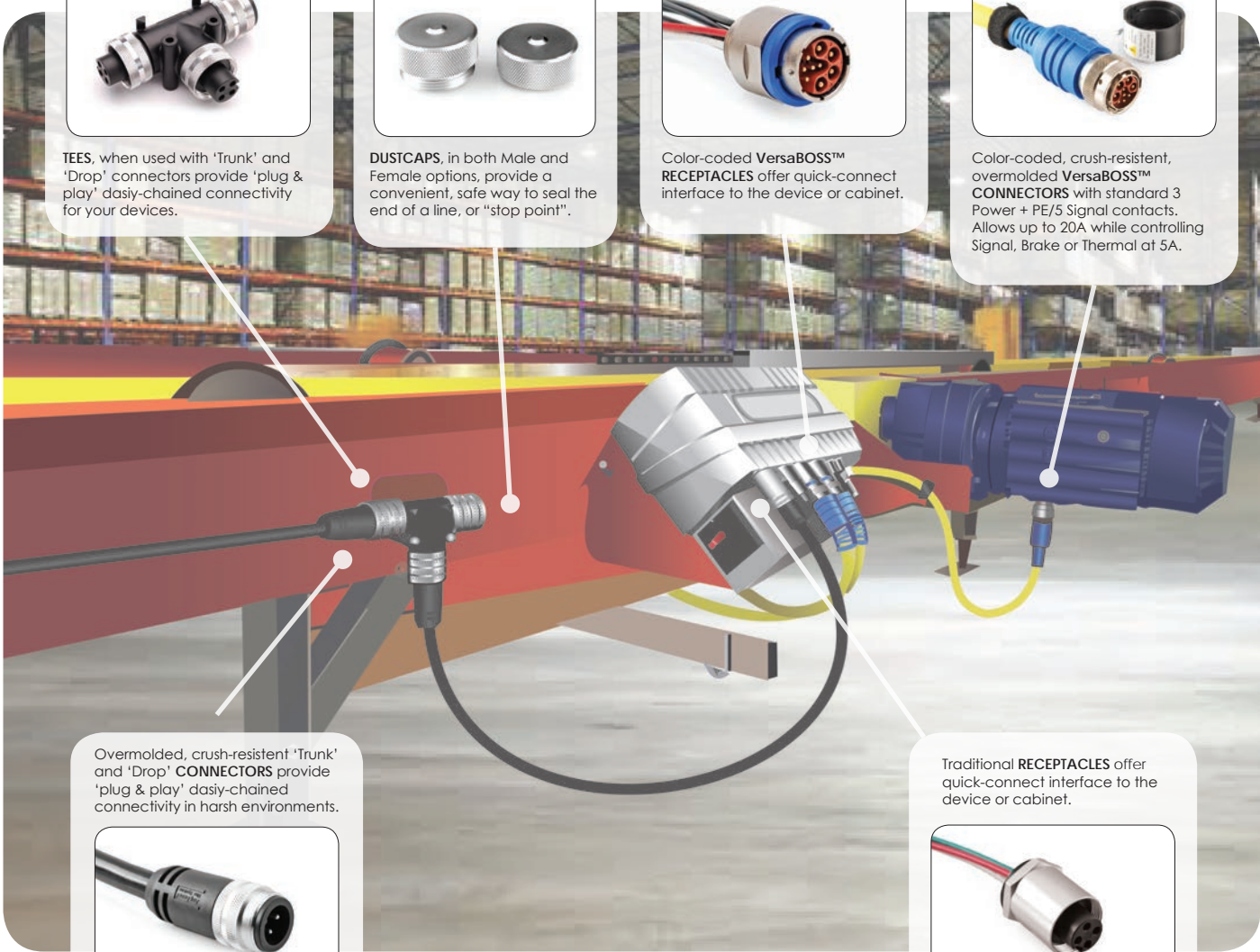

Overmolded, crush-resistant 'Trunk' and 'Drop' **CONNECTORS** provide 'plug & play' daisy-chained connectivity in harsh environments.



Traditional **RECEPTACLES** offer quick-connect interface to the device or cabinet.

## Custom Solutions

We offer custom solutions to meet your specific needs. Contact one of our Sales Representatives at +1 800 394 7732.

















### M35 (1 3/8") - 3 & 4 Position Specifications

Temperature Range	-20°C to +90°C Single-rated; -20°C to +105°C Dual-rated	Contact Plating	5µ"(min) Gold over 25µ"(min) Nickel
Body	Oil resistant PVC	Connector Face	PVC
Contacts	Gold-plating over Copper Alloy	Coupler Housing	Machined Aluminum, Anodized
Protection	IP67, NEMA 6P	Receptacle Housing	Machined Aluminum, Anodized
NFPA-79	Meets standards for motor/branch circuits	Short Circuit Rating	65kA

Single and Dual Rating Specifications				
Cable Trunk - <b>Single-rated</b>	PVC insulated #10AWG stranded copper (105 x 30)	<b>TC-ER Only</b> UL Listed; FT-4 Flame Rating	600V, 90°C Dry/Wet	Black TPE Cable Jacket
Cable Trunk - <b>Dual-rated</b>	PVC insulated #10AWG stranded copper (105 x 30)	<b>TC-ER/STOOW:</b> UL listed; FT2; CSA certified type STOOW	600V, 90°C Dry/75°C Wet (TC-ER), 105°C (STOOW)	Black PVC Cable Jacket





















### M35 (1 3/8") - 3 & 4 Position Trunk Cable Assemblies

Mxxx = length in meters

	3 Pos. (Trunk); 600V; 30A; 10AWG		4 Pos. (Trunk); 600V; 25A; 10AWG
Cable Diameter	0.48" (12.2mm) Single-rated; 0.67" (17.0mm) Dual-rated		0.56" (14.2mm) Single-rated; 0.72" (18.3mm) Dual-rated
Color Code	1-Black, 2-Green, 3-White		1-Black, 2-Grn/Yel, 3-Red, 4-White
Overmold Colors	Black	Red	Black
Male Straight, Single-rated (See FIG 1, Pg 20)	 P30768-Mxxx	 P30882-Mxxx	 P30752-Mxxx
Male 90, Single-rated (See FIG 3, Pg 20)	 P30769-Mxxx	 P30885-Mxxx	 P30753-Mxxx
Female Straight, Single-rated (See FIG 2, Pg 20)	 P30770-Mxxx	 P30883-Mxxx	 P30754-Mxxx
Female 90, Single-rated (See FIG 4, Pg 20)	 P30771-Mxxx	 P30886-Mxxx	 P30755-Mxxx
Male Straight, Dual-rated (See FIG 1, Pg 20)	 P29000-Mxxx	-	 P28992-Mxxx
Male 90, Dual-rated (See FIG 3, Pg 20)	 P29001-Mxxx	-	 P28993-Mxxx





M35 (1 3/8") - 3 & 4 Position Trunk Cable Assemblies, cont.

Mxxx = length in meters

	3 Pos. (Trunk); 600V; 30A; 10AWG		4 Pos. (Trunk); 600V; 25A; 10AWG
Cable Diameter	0.48" (12.2mm) Single-rated; 0.67" (17.0mm) Dual-rated		0.56" (14.2mm) Single-rated; 0.72" (18.3mm) Dual-rated
Color Code	1-Black, 2-Green, 3-White		1-Black, 2-Grn/Yel, 3-Red, 4-White
Overmold Colors	Black	Red	Black
Female Straight, Dual-rated (See FIG 2, Pg 20)	 P29004-Mxxx		 P28996-Mxxx
Female 90, Dual-rated (See FIG 4, Pg 20)	 P29005-Mxxx		 P28997-Mxxx
Male Str/ Female Straight, Single-rated (See FIG 1 and 2, Pg 20)	 P30764-Mxxx	 P30881-Mxxx	 P30748-Mxxx
Male Str/ Female 90, Single-rated (See FIG 1 and 4, Pg 20)	 P30765-Mxxx	 P30887-Mxxx	 P30749-Mxxx
Male 90/ Female Straight, Single-rated (See FIG 2 and 3, Pg 20)	 P30766-Mxxx	 P30888-Mxxx	 P30750-Mxxx
Male 90/ Female 90, Single-rated (See FIG 3 and 4, Pg 20)	 P30767-Mxxx	 P30884-Mxxx	 P30751-Mxxx
Male Straight/ Female Straight, Dual-rated (See FIG 1 and 2, Pg 20)	 P28984-Mxxx	 P30253-Mxxx	 P28976-Mxxx
Male Straight/ Female 90, Dual-rated (See FIG 1 and 4, Pg 20)	 P28985-Mxxx		 P28977-Mxxx











### M35 (1 3/8") - 3 & 4 Position Trunk Cable Assemblies, cont.

Mxxx = length in meters













	3 Pos. (Trunk); 600V; 30A; 10AWG		4 Pos. (Trunk); 600V; 25A; 10AWG	
Male 90/ Female Straight, Dual-rated  (See FIG 2 and 3, Pg 20)	 P28986-Mxxx		 P28978-Mxxx	
Male 90/ Female 90, Dual-rated  (See FIG 3 and 4, Pg 20)	 P28987-Mxxx		 P28979-Mxxx	
Male 90/Female Straight, Single-rated, <b>SHIELDED</b>  (See FIG 2 and 3, Pg 20)			 P29359-Mxxx	

### M35 (1 3/8") - 3 & 4 Position Trunk Receptacles









Mxxx = length in meters

	3 Pos. (Trunk); 600V/30A; 10AWG		4 Pos. (Trunk); 600V/25A; 10AWG	
Color Code	1-Black, 2-Green, 3-White		1-Black, 2-Grn/Yel, 3-Red, 4-White	
Thread Type	1/2-14NPT	3/4-14NPT	1/2-14NPT	3/4-14NPT
Male, Standard Wire Color External Threads  (See FIG 5 and 7, Pg 20)	 P29030-Mxxx	 P29028-Mxxx	 P29059-Mxxx	 P29057-Mxxx
Female, Standard Wire Color Internal Threads  (See FIG 6 and 8, Pg 20)	 P29034-Mxxx	 P29032-Mxxx	 P29026-Mxxx	 P29024-Mxxx
Female, Specialty Wire Color (BLK, GR/YEL, BLK, BLK) Internal Threads (See FIG 6 and 8, Pg 20)			 P29360-Mxxx	 P29361-Mxxx

### M35 (1 3/8") - 3 & 4 Position Tees

	3 Pos.; 600V; 30A (Trunk), 15A (Drop)		4 Pos.; 600V; 25A (Trunk), 15A (Drop)	
Overmold Colors	Black	Red	Black	Red
Standard  (See FIG 9 and 14 Pg 21-22)	 P28966	 P29855	 P28964	 P30869
"h" Tee  (See FIG 11 and 16 Pg 21, 23)	 P30862	 P30716	 P30866	 P30864
WYE Tee  (See FIG 13 and 18 Pg 22, 24)	 P31000	 P31001	 P29364	 P31002

M35 (1 3/8") - 3 & 4 Position Tees, cont

	3 Pos.; 600V; 30A (Trunk), 15A (Drop)		4 Pos.; 600V; 25A (Trunk), 15A (Drop)	
Overmold Colors	Black	Red	Black	Red
Reducing Drop M35 (1 3/8") to M22 (7/8") <small>(See FIG 10 and 15 Pg 21, 23)</small>	 P28970	 P30868	 P28968	 P30870
"h" Tee, Reducing Drop M35 (1 3/8") to M22 (7/8") <small>(See FIG 12 and 17 Pg 22-23)</small>	 P30863	 P30717	 P30867	 P30865

M35 (1 3/8") to M22 (7/8") - 3 & 4 Position In-Line Reducers

	3 Pos.; 600V; 15A		4 Pos.; 600V; 15A	
Overmold Colors	Black	Red	Black	Red
Male M35 Trunk/ Female M22 Drop <small>(See FIG 13 and 18 Pg 22, 24)</small>	 P28974	 P29858	 P28972	 P30871

M35 (1 3/8") & M22 (7/8") - Accessories

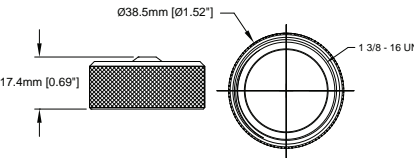
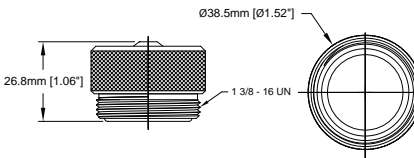
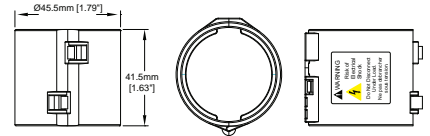
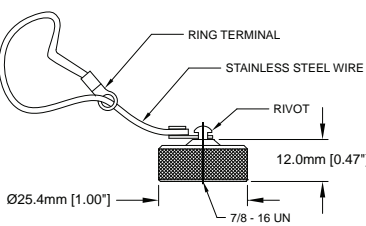
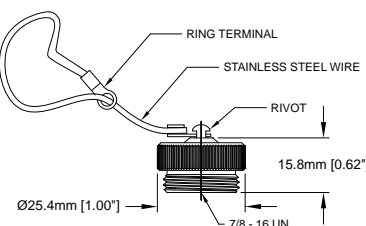
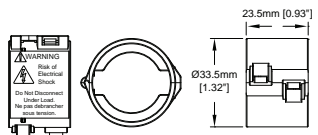
M35, Dustcap, Metal, Male Trunk w Internal Threads P29042	M35, Dustcap, Metal, Female Trunk w External Threads P29043	M35, Locking Clip, Trunk P29040
		 <b>WARNING LABEL READS:</b> Risk of Electrical Shock Do Not Disconnect Under Load. Ne pas debrancher sous tension.
M22, Dustcap, Metal, Male Drop w Internal Threads P29044	M22, Dustcap, Metal, Female Drop w External Threads P29045	M22, Locking Clip, Drop P29041
		 <b>WARNING LABEL READS:</b> Risk of Electrical Shock Do Not Disconnect Under Load. Ne pas debrancher sous tension.

All Dimensions in: mm [inch]

## Dimensional Drawings

FIG 1: Male, Plug, Straight, Trunk, 3 and 4 Position

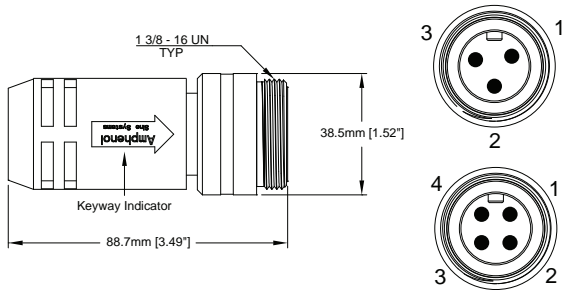

FIG 2: Female, Plug, Straight, Trunk, 3 and 4 Position

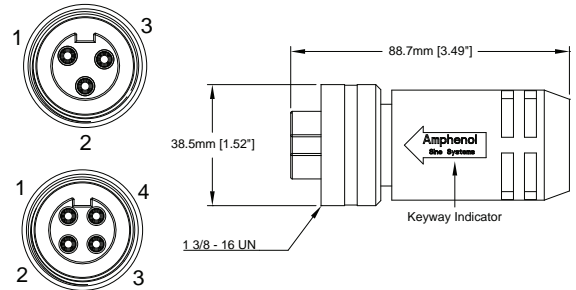

FIG 3: Male, Plug, 90°, Trunk, 3 and 4 Position

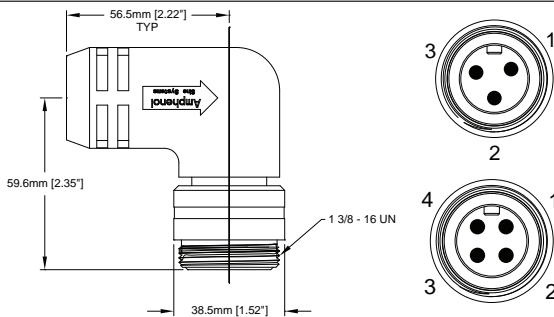

FIG 4: Female, Plug, 90°, Trunk, 3 and 4 Position

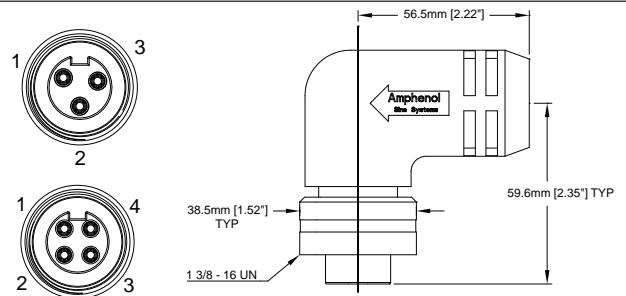

FIG 5: Male, 1/2-14NPT Receptacle, Trunk, 3 and 4 Position

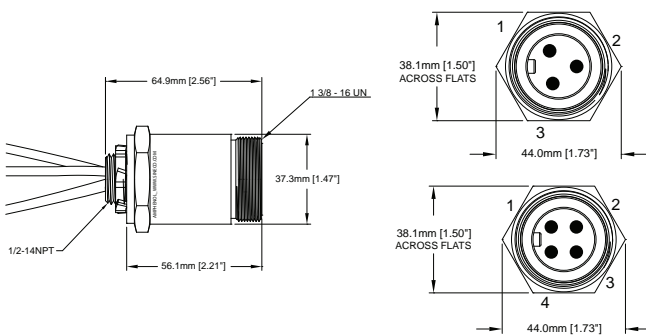

FIG 6: Female, 1/2-14NPT Receptacle, Trunk, 3 and 4 Position

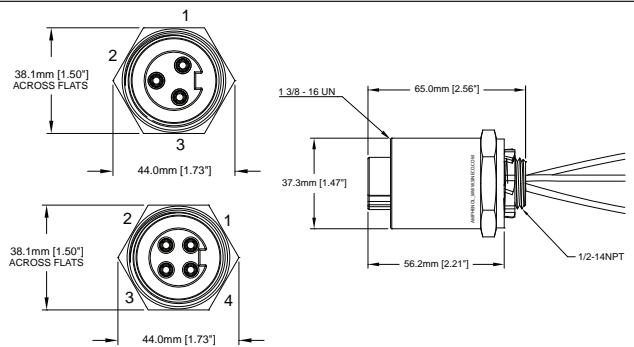

FIG 7: Male, 3/4-14NPT Receptacle, Trunk, 3 and 4 Position

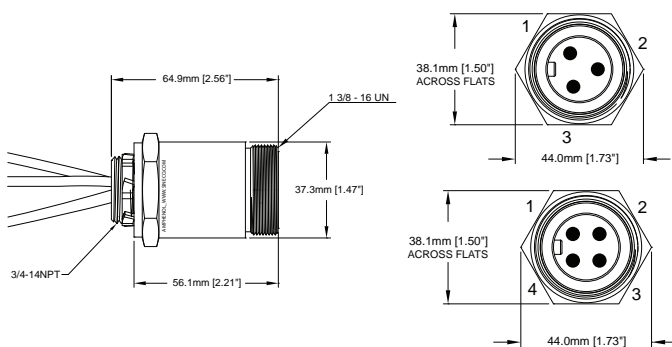
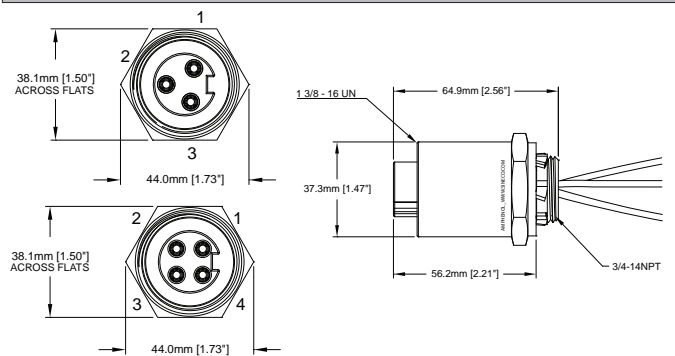

FIG 8: Female, 3/4-14NPT Receptacle, Trunk, 3 and 4 Position



All Dimensions in: mm [inch]

Dimensional Drawings, cont

FIG 9: Tee, 3 Position

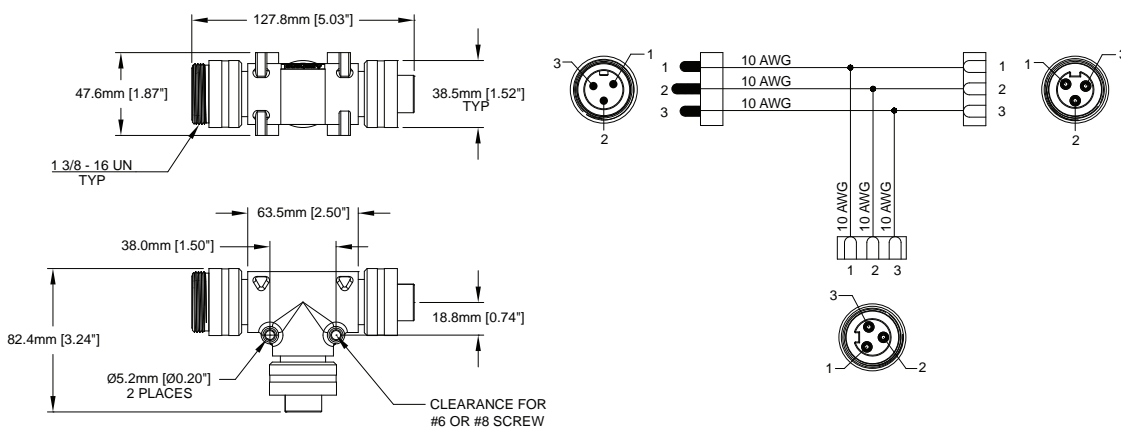

FIG 10: Reducing Tee, 3 Position

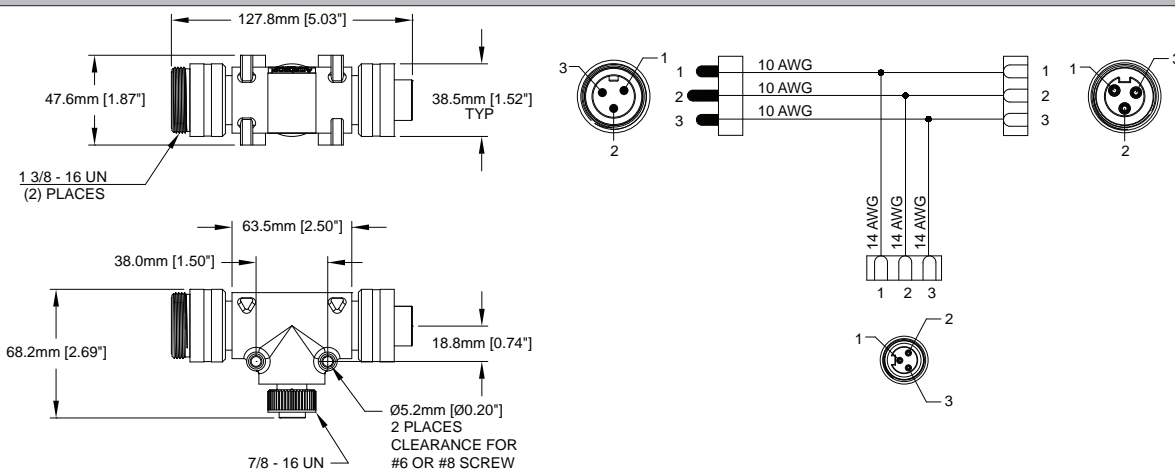
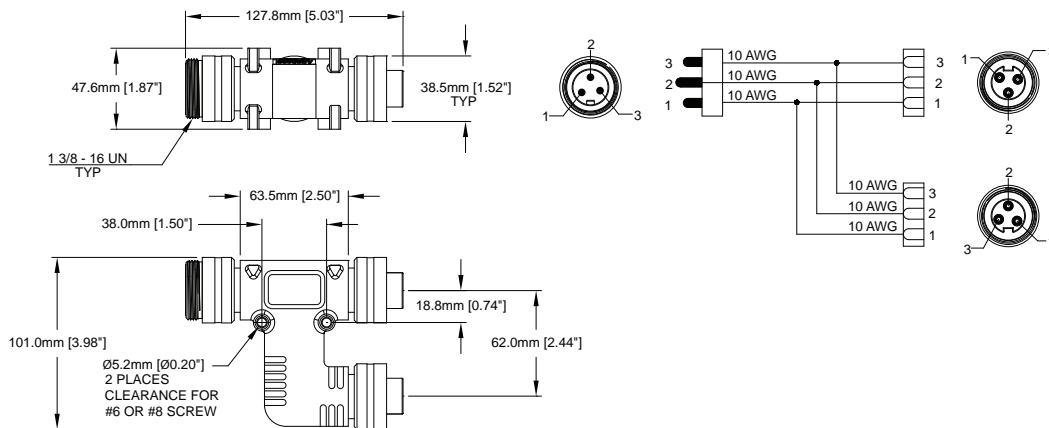

FIG 11: "h" Tee, 3 Position



All Dimensions in: mm [inch]



Dimensional Drawings, cont

FIG 12: "h" Reducing Tee, 3 Position

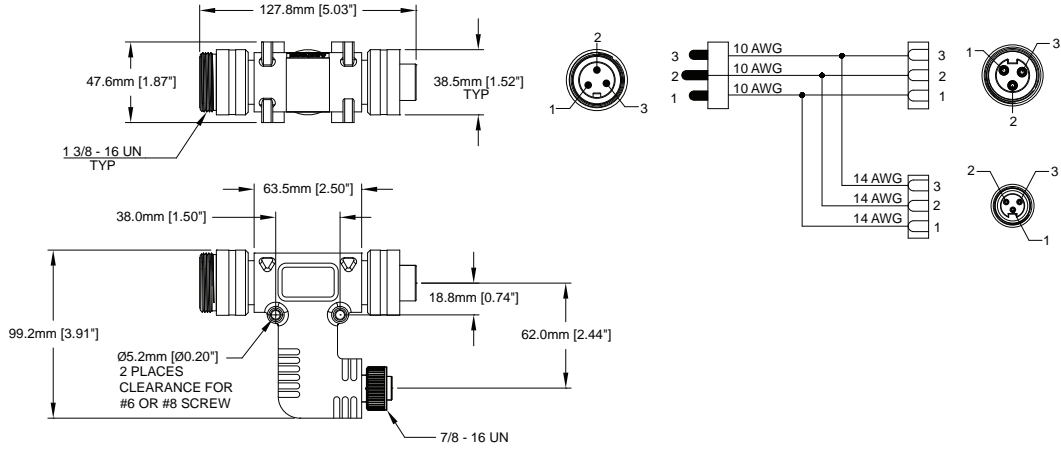

FIG 13: WYE Tee, 3 Position

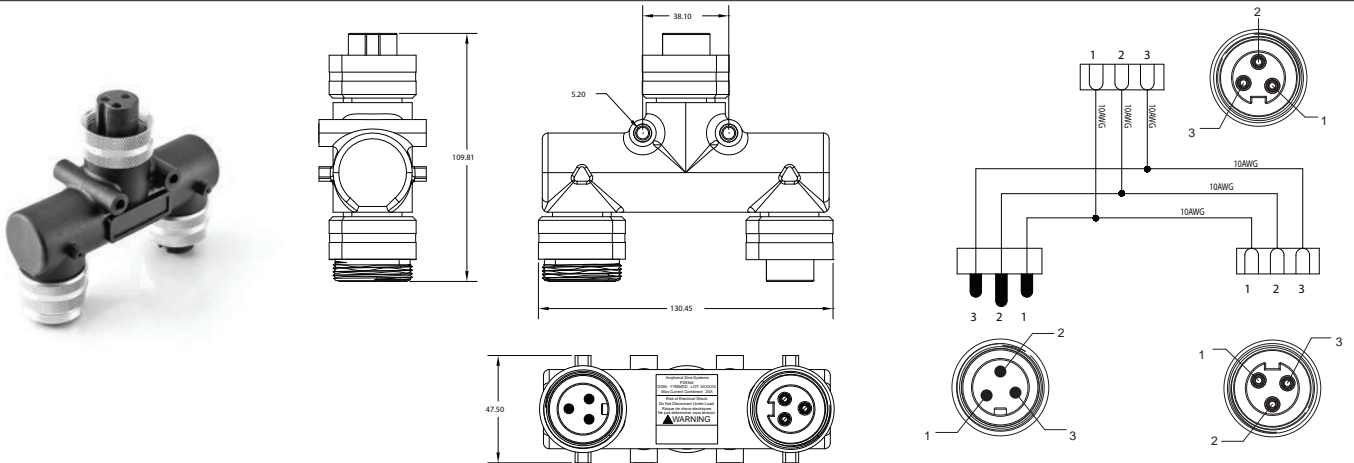
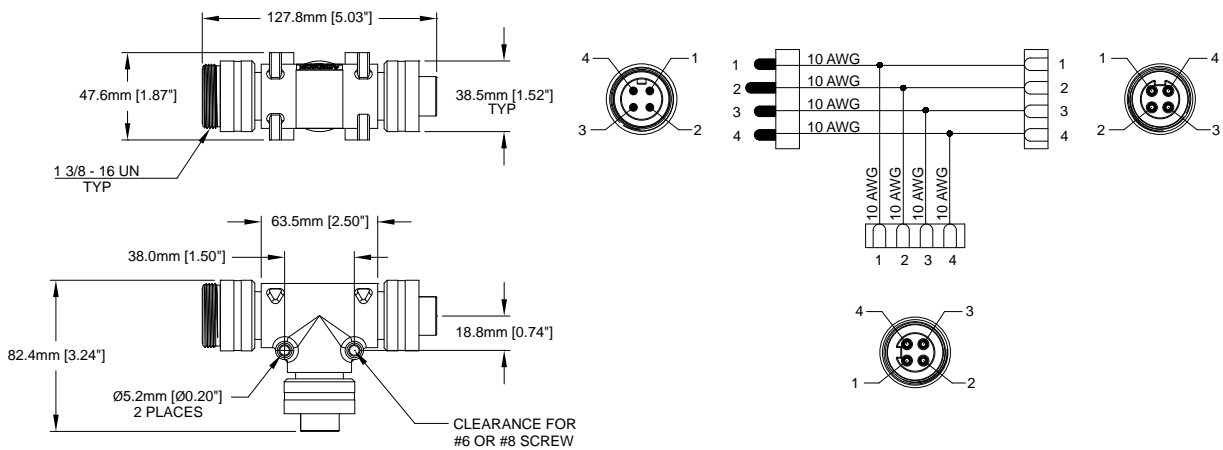

FIG 14: Tee, 4 Position



All Dimensions in: mm [inch]

Dimensional Drawings, cont

FIG 15: Reducing Tee, 4 Position

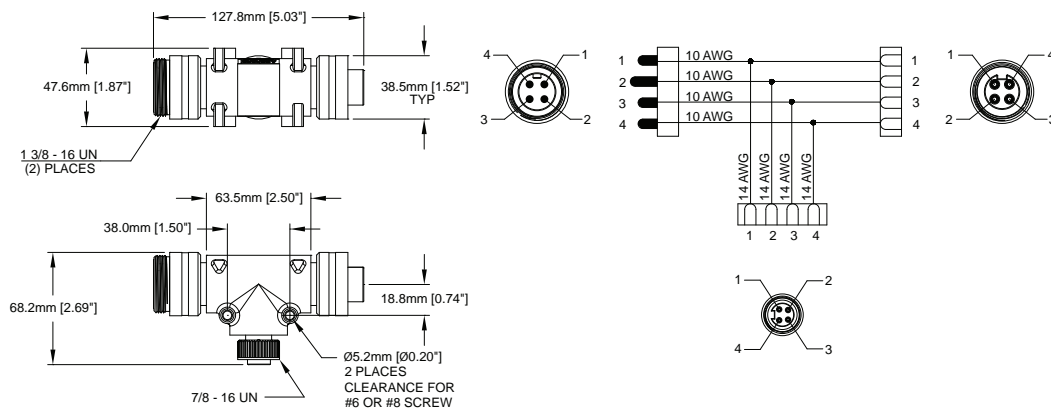

FIG 16: "h" Tee, 4 Position

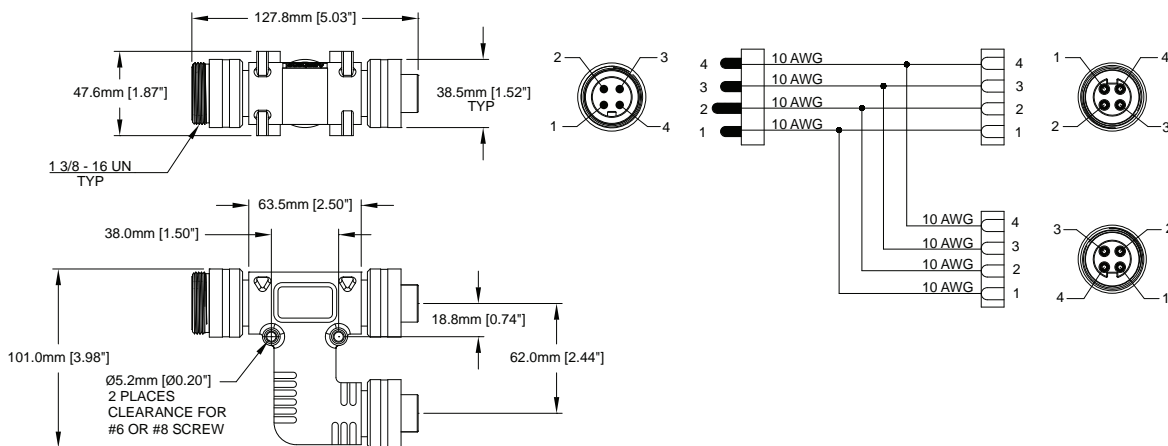
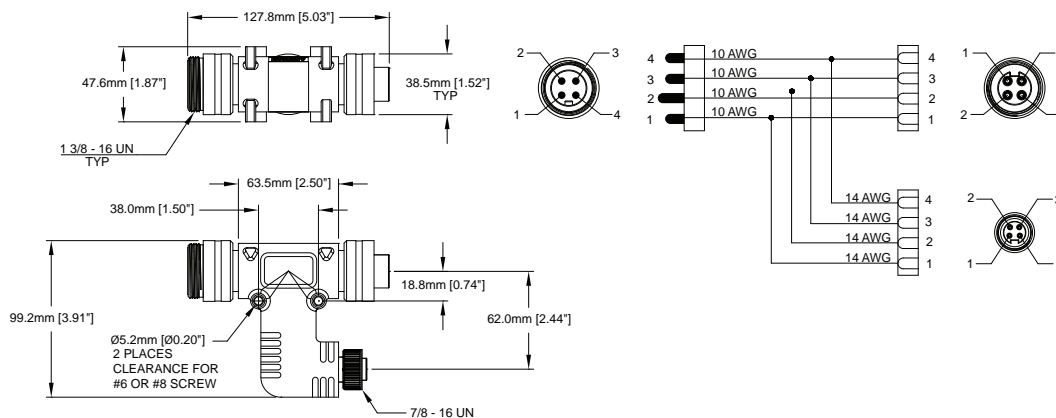

FIG 17: "h" Reducing Tee, 4 Position



All Dimensions in: mm [inch]

Dimensional Drawings, cont

FIG 18: WYE Tee, 4 Position

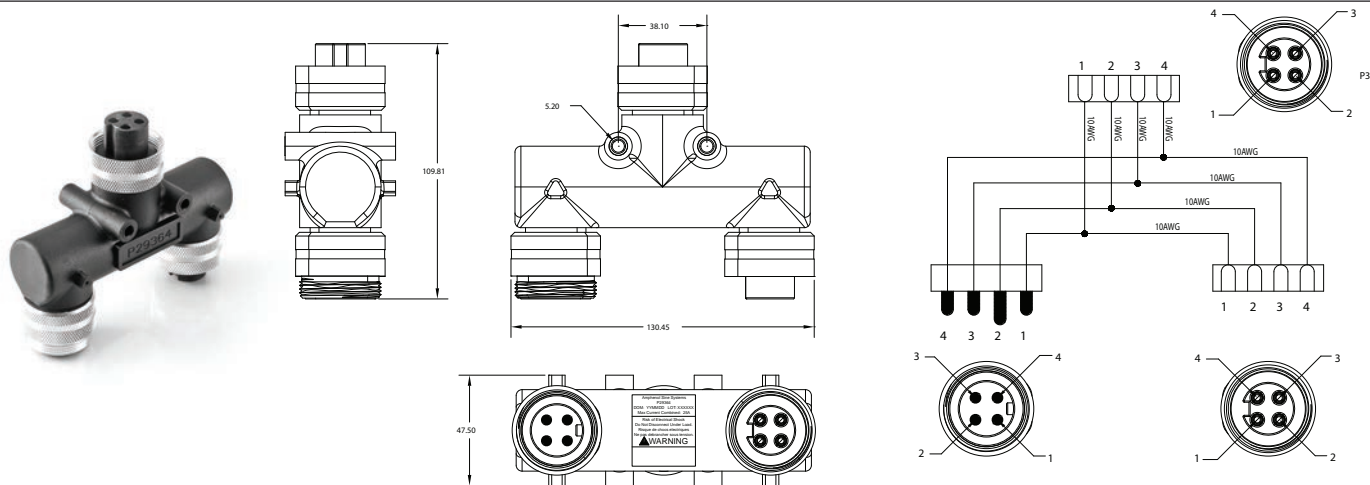

All Dimensions in: mm [inch]

This page intentionally left blank.

# PowerBOSSlite™ M22

Power Distribution System



# PowerBOSSlite™ M22

















## PowerBOSSlite™ M22 (7/8") Specifications

Temperature Range	-20°C to +90°C Single-rated/-20°C to +105°C Dual-rated	Contact Plating	5µ" (min) Gold over 25µ" (min) Nickel
Body	Oil resistant PVC	Connector Face	PVC
Contacts	Copper Alloy	Coupler Housing	Machined Aluminum, Anodized
Protection	IP67, NEMA 6P	Receptacle Housing	Machined Aluminum, Anodized



















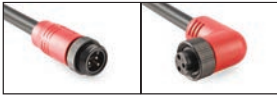



Single and Dual Rating Specifications				
Cable Drop - <b>Single-rated</b>	PVC insulated #14AWG stranded copper (41 x 30)	<b>TC-ER Only:</b> UL Listed; FT-4 Flame Rating	600V, 90°C Dry/Wet	Black TPE Cable Jacket
Cable Drop - <b>Dual-rated</b>	PVC insulated #14AWG stranded copper (105 x 34)	<b>TC-ER/STOOW;</b> UL listed; FT2; CSA certified type STOOW	600V, 90°C Dry/75°C Wet (TC-ER), 105°C (STOOW)	Black PVC Cable Jacket

## M22 (7/8") - 3 and 4 Position Drop/Branch Cable Assemblies

Mxxx = length in meters

	3 Pos. (Drop/Branch); 600V; 15A; 14AWG		4 Pos. (Drop/Branch); 600V; 15A; 14AWG
Cable Diameter	0.37" (9.4mm) Single-rated 0.53" (13.5mm) Dual-rated		0.40" (10.2mm) Single-rated 0.57" (14.5mm) Dual-rated
Color Code	1-Green, 2-Black, 3-White		1-Black, 2-White, 3-Red, 4-Green
Overmold Colors	Black	Red	Black
Male Straight, Single-rated (See FIG 1, Pg 30)	 P30776-Mxxx	 P30890-Mxxx	 P30760-Mxxx
Male 90, Single-rated (See FIG 3, Pg 30)	 P30777-Mxxx	 P30893-Mxxx	 P30761-Mxxx
Female Straight, Single-rated (See FIG 2, Pg 30)	 P30778-Mxxx	 P30891-Mxxx	 P30762-Mxxx
Female 90, Single-rated (See FIG 4, Pg 30)	 P30779-Mxxx	 P30894-Mxxx	 P30763-Mxxx
Male Straight, Dual-rated (See FIG 1, Pg 30)	 P29020-Mxxx		 P29016-Mxxx
Male 90, Dual-rated (See FIG 3, Pg 30)	 P29021-Mxxx		 P29017-Mxxx

M22 (7/8") - 3 and 4 Position Drop/Branch Cable Assemblies, cont. Mxxx = length in meters

	3 Pos. (Drop/Branch); 600V; 15A; 14AWG		4 Pos. (Drop/Branch); 600V; 15A; 14AWG
Cable Diameter	0.37" (9.4mm) Single-rated 0.53" (13.5mm) Dual-rated		0.40" (10.2mm) Single-rated 0.57" (14.5mm) Dual-rated
Color Code	1-Green, 2-Black, 3-White		1-Black, 2-White, 3-Red, 4-Green
Overmold Colors	Black	Red	Black
Female Straight, Dual-rated (See FIG 2, Pg 30)	 P29022-Mxxx		 P29018-Mxxx
Female 90, Dual-rated (See FIG 4, Pg 30)	 P29023-Mxxx		 P29019-Mxxx
Male Straight/ Female Straight, Single-rated (See FIG 1 and 2, Pg 30)	 P30772-Mxxx	 P30889-Mxxx	 P30756-Mxxx
Male Straight/ Female 90, Single-rated (See FIG 1 AND 4, Pg 30)	 P30773-Mxxx	 P30895-Mxxx	 P30757-Mxxx
Male 90/ Female Straight, Single-rated (See FIG 2 and 3, Pg 30)	 P30774-Mxxx	 P30896-Mxxx	 P30758-Mxxx
Male 90/ Female 90, Single-rated (See FIG 3 and 4, Pg 30)	 P30775-Mxxx	 P30892-Mxxx	 P30759-Mxxx
Male Straight/ Female Straight, Dual-rated (See FIG 1 and 2, Pg 30)	 P29012-Mxxx	 P30254-Mxxx	 P29008-Mxxx
Male Straight/ Female 90, Dual-rated (See FIG 1 and 4, Pg 30)	 P29013-Mxxx		 P29009-Mxxx
Male 90/ Female Straight, Dual-rated (See FIG 2 and 3, Pg 30)	 P29014-Mxxx		 P29010-Mxxx

# PowerBOSSlite™ M22



## M22 (7/8") - 3 & 4 Position Drop/Branch Cable Assemblies, cont. Mxxx = length in meters

	3 Pos. (Drop/Branch); 600V; 15A; 14AWG	4 Pos. (Drop/Branch); 600V; 15A; 14AWG
Cable Diameter	0.37" (9.4mm) Single-rated 0.53" (13.5mm) Dual-rated	0.40" (10.2mm) Single-rated 0.57" (14.5mm) Dual-rated
Color Code	1-Green, 2-Black, 3-White	
Overmold Colors	Black	Red
Male 90/ Female 90, Dual-rated  (See FIG 3 and 4, Pg 30)	 P29015-Mxxx	 P29011-Mxxx
M-Str/F-HAN Q4/2, Dual-rated (See FIG 1, Pg 30)  *UL Approval Pending As An Assembly		 P30746-Mxxx

## M22 (7/8") - 3 & 4 Position Drop/Branch Receptacles Mxxx = length in meters

	3P Drop/Branch	4P Drop/Branch
Voltage/Current	600V/15A	600V/15A
Conductor	14AWG	14AWG
Color Code	1-Green, 2-Black, 3-White	1-Black, 2-White, 3-Red, 4-Green
Male, External Threading  (See FIG 5, Pg 30)	 P29038-Mxxx	 P29036-Mxxx
Female, Internal Threading  (See FIG 6, Pg 30)	 P29039-Mxxx	 P29037-Mxxx
Male, M20 Threading  (See FIG 7, Pg 30)		 P30727-Mxxx

## M22 (7/8") - Accessories

All Dimensions in: mm [inch]

M22, Dustcap, Metal, Male Drop w Internal Threads	P29044	M22, Dustcap, Metal, Female Drop w External Threads	P29045	M22, Locking Clip, Drop	P29041



## Dimensional Drawings

FIG 1: Male, Plug, Straight, Drop/Branch, 3 and 4 Position

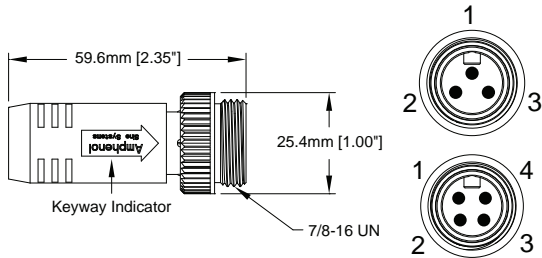

FIG 2: Female, Plug, Straight, Drop/Branch, 3 and 4 Position

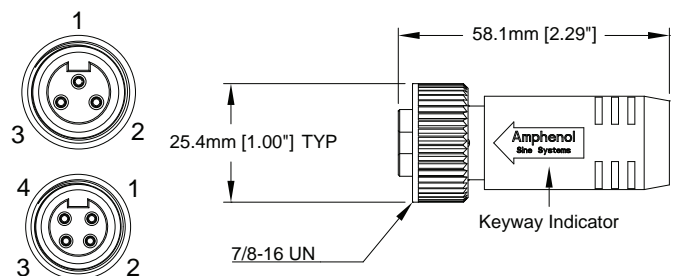

FIG 3: Male, Plug, 90°, Drop/Branch, 3 and 4 Position

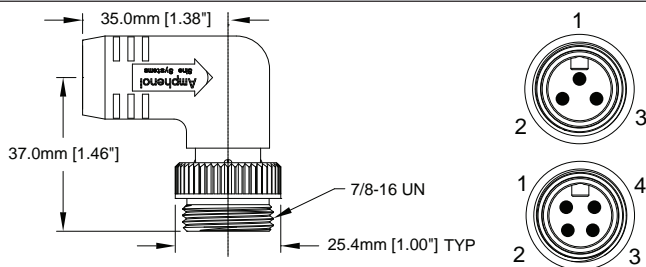

FIG 4: Female, Plug, 90°, Drop/Branch, 3 and 4 Position

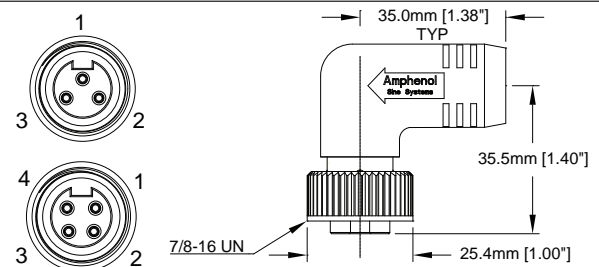

FIG 5: Male, Receptacle, Straight, Drop, 3 and 4 Position

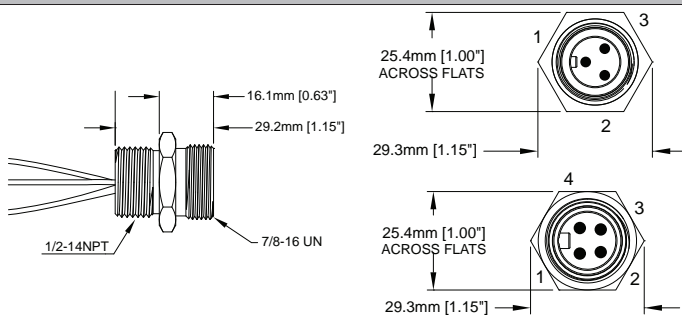

FIG 6: Female, Receptacle, Straight, Drop, 3 and 4 Position

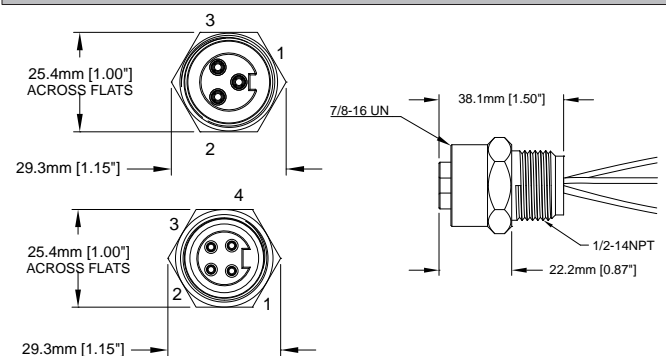
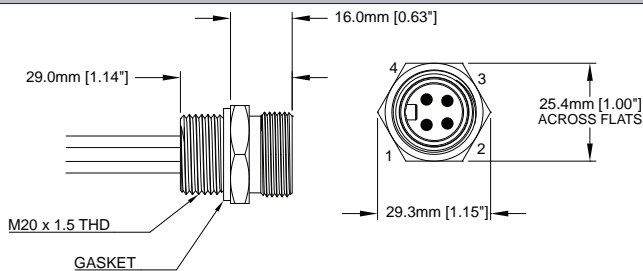

FIG 7: Male, Receptacle, M20 Threading, Straight, Drop, 4 Position



All Dimensions in: mm [inch]

This page intentionally left blank.

# PowerBOSS™ M40

featuring



Easy 'Plug & Play' Installation • Scalable • Easy to Repeat  
 Faster Install & Labor Times • Faster to Market Time • Less Downtime  
 Increased Worker Productivity • Elimination of Specialized Tooling  
 Reduced Maintenance, Manufacturing and Labor Costs

(This layout includes our VersaBOSS™ product line. Please reference pages 68-84 for product specifics.)



Trunk **TEE** connectors provide 'plug & play' daisy-chained connectivity which is ideal for splitting main power trunk.



**TERMINATOR PLUGS** provide a convenient, safe way to seal the end of a line, or "stop point", which complete the "safety circuit".



Color-coded **VersaBOSS™ RECEPTACLES** offer quick-connect interface to the device or cabinet.



Color-coded, crush-resistant, overmolded **VersaBOSS™ CONNECTORS** with standard 3 Power + PE/5 Signal contacts. Allows up to 20A while controlling Signal, Brake or Thermal at 5A.



Crush-resistant 'Trunk' and 'Drop' **CONNECTORS** provide quick disconnects for fast installations and contain accessories to prevent accidental disconnection.

Tray-rated, exposed-run cable meets code requirements and replaces hard-wiring and conduit.



Traditional **RECEPTACLES** offer quick-connect interface to the device or cabinet.

### Custom Solutions

We offer custom solutions to meet your specific needs. Contact one of our Sales Representatives at +1 800 394 7732.

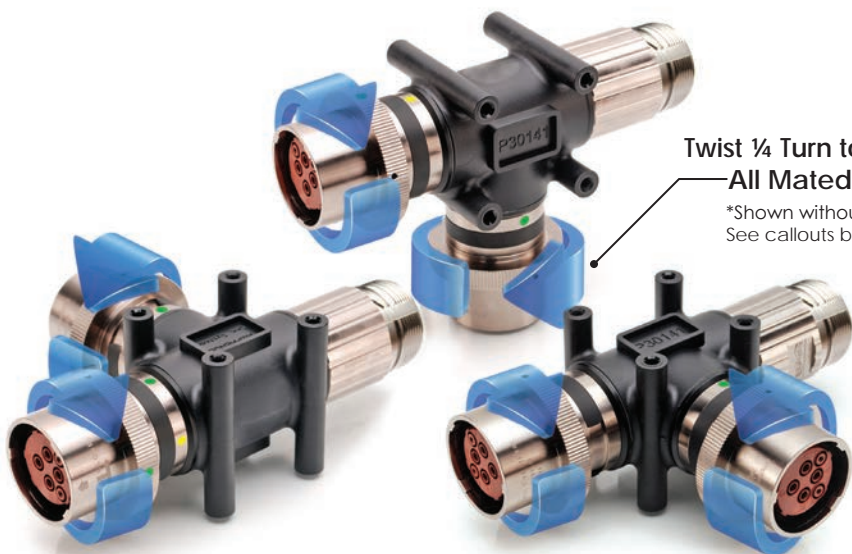

Twist ¼ Turn to Lock/Unlock  
All Mated Connections\*

\*Shown without GuardSafe™ Clips or Safety Sleeves for clarity.  
See callouts below.



**OPEN/CLOSE Indicator**

**Alignment Indicators**

Assists with Positive & Rapid Mating

**4 + 2  
Connector Layout**

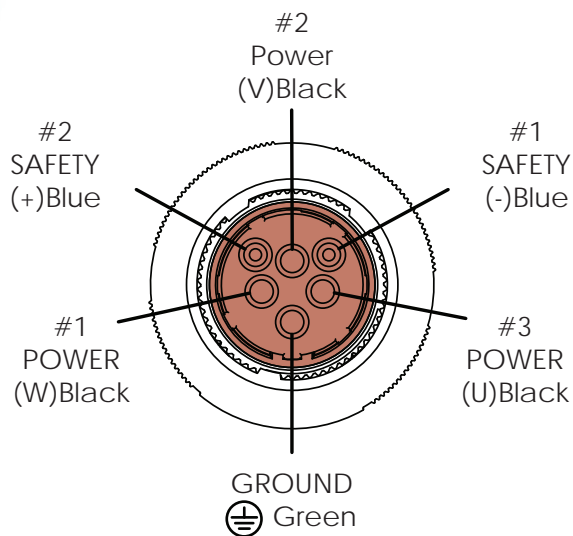

**GuardSafe™ Clip Assemblies (PN:10-80249)**  
Standard on Checkmate™ Products  
(To Prevent Accidental Unmating  
of Connections.)



**Safety Sleeves (PN:10-80249)**  
Are Standard on Checkmate™ Products  
(To Prevent Damage to Connector Threads.)

This page intentionally left blank.

## M40 featuring Checkmate™ - 6 Position Specifications











Temperature Range	-20°C to 105°C	Dielectric Test Voltage	2200V
Coupling Nut	Machined Aluminum, Anodized	Protection	IP67 (Mated Condition)
Insulation Insert	Thermoplastic, UL 94/V-0	Mating Cycles	>500
Contact	Gold Flash Plating over Copper Alloy	Vibration Resistance	Per MIL-STD-202 Method 204
Bend Radius Limiter	Thermoplastic, Black	Thermal Shock	Per MIL-STD-202 Method 207
Cable Jacket Material	Available in PVC or TPE	48 Hour Salt Spray	Per MIL-STD-202 Method 101
Insulation Resistance	5000M OHMS	Short Circuit Rating	65kA
NFPA-79	Meets standards for motor/branch circuits		

Cable Trunk Rating Specifications				
Single-rated	PVC insulated, 10AWG stranded copper (105 x 30)	TC-ER Only UL Listed; FT-4 Flame Rating	600V, 90°C Dry/Wet	Black TPE Cable Jacket
	PVC insulated, 14AWG stranded copper (105 x 34)			
	PVC insulated, 8AWG stranded copper (7 x 19 x 29)			
Dual-rated	PVC insulated, 14AWG stranded copper (105 x 34)	TC-ER Only UL Listed; FT-4 Flame Rating	600V, 90°C Dry/Wet	Black TPE Cable Jacket
	PVC insulated, 10AWG stranded copper (105 x 30)			
	PVC insulated, 14AWG stranded copper (105 x 34)			
	PVC insulated, 8AWG stranded copper (7 x 19 x 29)			
High Flex	PVC insulated, 10AWG stranded copper (105 x 30)	TC-ER/STOOW; UL listed; FT2; CSA certified type STOOW	600V, 90°C Dry/75°C Wet (TC-ER) 105°C (STOOW)	Black PVC Cable Jacket
	PVC insulated, 14AWG stranded copper (105 x 34)			
	PVC insulated, 8AWG stranded copper (7 x 19 x 29)			
High Flex	PVC insulated, 10AWG stranded copper (105 x 30)	TC-ER/STOOW; UL listed; FT2; CSA certified type STOOW	600V, 90°C Dry/75°C Wet (TC-ER) 105°C (STOOW)	Black PVC Cable Jacket
	PVC insulated, 16AWG stranded copper (65 x 34)			

The Industrial@Amphenol products found within this section are UL 2237 Listed for the amperage ratings provided. However, for higher amperage requirements with governances outside of this specific UL listing, please consult your salesperson as higher amperage values may be applicable.

## M40 featuring Checkmate™ - 6 Position Cable Assemblies

Mxxx = length in meters





	6 Pos.; 600V; Power 32A, Signal 5A	6 Pos.; 600V; Power 25A, Signal 5A
Color Code (Ref. Pg 34)	U - Black, V - Black, W - Black, Ground - Green, "+" - Blue, "-" - Blue, Shield	
Number of Contacts	4C <b>8AWG</b> x 1 Shielded 14AWG Pair	4C <b>10AWG</b> x 1 Shielded 14AWG Pair
Male Straight, TPE Jacket, Single-rated, Black (See FIG 1, Pg 39)	 P30668-Mxxx	 P30671-Mxxx
Female Straight, TPE Jacket, Single-rated, Black (See FIG 2, Pg 39)	 P30669-Mxxx	 P30672-Mxxx
Male Straight, TPE Jacket, Single-rated, High Flex Cable, Yellow (See FIG 1, Pg 39)		 P30241-Mxxx
Female Straight, TPE Jacket, Single-rated, High Flex Cable, Yellow (See FIG 2, Pg 39)		 P30242-Mxxx
Male Straight, PVC Jacket, Dual-rated, Black (See FIG 1, Pg 39)	 P30237-Mxxx	 P30239-Mxxx
Female Straight, PVC Jacket, Dual-rated, Black (See FIG 2, Pg 39)	 P30238-Mxxx	 P30240-Mxxx

M40 featuring Checkmate™ - 6 Position Cable Assemblies, cont. Mxxx = length in meters



	6 Pos.; 600V; Power 32A, Signal 5A	6 Pos.; 600V; Power 25A, Signal 5A
Color Code (Ref. Pg 34)	U - Black, V - Black, W - Black, Ground - Green, "+" - Blue, "-" - Blue, Shield	
Number of Contacts	4C <b>8AWG</b> x 1 Shielded 14AWG Pair	4C; <b>10AWG</b> x 1 Shielded 14AWG Pair
Male/Female Straight, TPE Jacket, Single-rated, Black (See FIG 3, Pg 39)	 P30667-Mxxx	 P30670-Mxxx
Male/Female Straight, TPE Jacket, Single-rated, High Flex Cable, Yellow (See FIG 3, Pg 39)		 P30189-Mxxx
Male/Female Straight, PVC Jacket, Dual-rated, Black (See FIG 3, Pg 39)	 P30142-Mxxx	 P30143-Mxxx

M40 featuring Checkmate™ - 6 Position Receptacles

Mxxx = length in meters

	6 Pos.; 600V; 32A Power, 5A Signal		
Color Code (Ref. Pg 34)	U - Black, V - Black, W - Black, Ground - Green, "+" - Blue, "-" - Blue, Shield		
Number of Contacts	4C <b>8AWG</b> x 2 Conductor 14AWG	4C <b>10AWG</b> x 2 Conductor 14AWG	4C <b>10AWG</b> x 2 Conductor 14AWG (w/ M25 Adapter)
Male Straight (See FIG 4, Pg 39)	 P30256-Mxxx	 P30257-Mxxx	 P30163-Mxxx
Female Straight (See FIG 5, Pg 39)	 P30146-Mxxx	 P30147-Mxxx	



M40 featuring Checkmate™ - 6 Position Tees

	Standard	Angled Leg
Voltage/Current	600V/32A	
Trunk to Trunk (See FIG 7 and 8, Pg 40)	 P30141	 P30715

All Dimensions in: mm [inch]

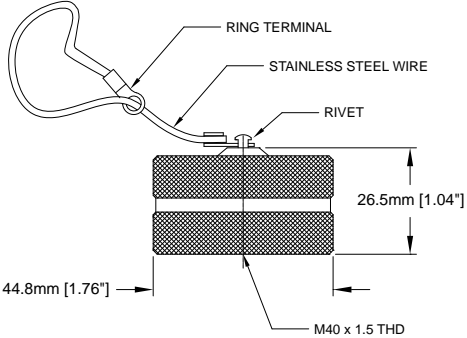
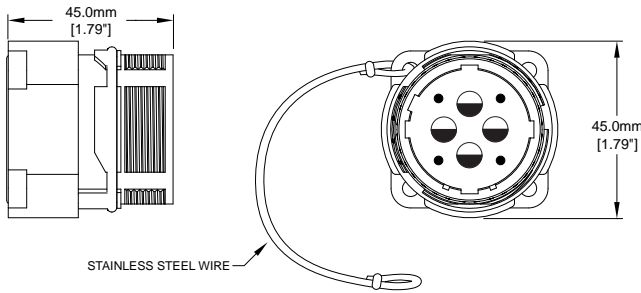
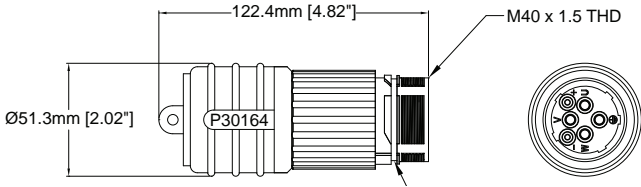
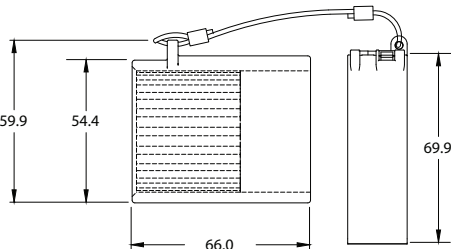
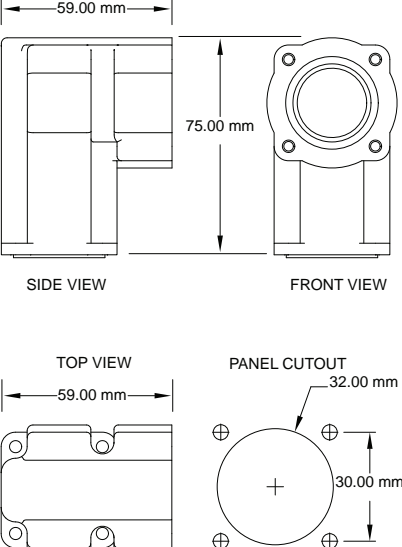

## M40 featuring Checkmate™ - Accessories

<p>M40, Checkmate™, Dustcap for Male Connector</p>	<p>P29851</p>	<p>M40, Checkmate™, "Potted" Dustcap for Female Connector</p>	<p>P30510</p>
			
<p>M40, Checkmate™, 6 Pos., Terminator Plug, O-Ring</p>	<p>P30164</p>	<p>M40, Checkmate™, Safety Sleeve and Clip Assembly</p>	<p>10-80249</p>
			
<p>M40, Checkmate™, 90° Mounting Adapter</p>	<p>34-80289</p>		
			

All Dimensions in: mm [inch]

## Dimensional Drawings

**FIG 1: Male, Plug, Straight, 6 Position**

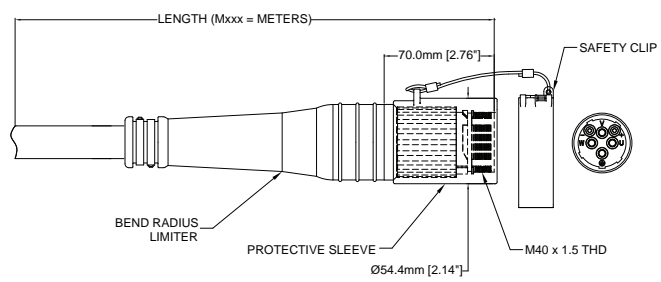

**FIG 2: Female, Plug, Straight, 6 Position**

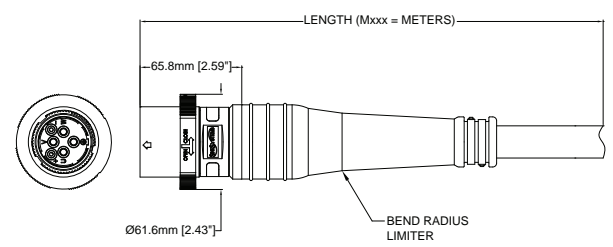

**FIG 3: Male to Female, Plug, Straight, 6 Position**

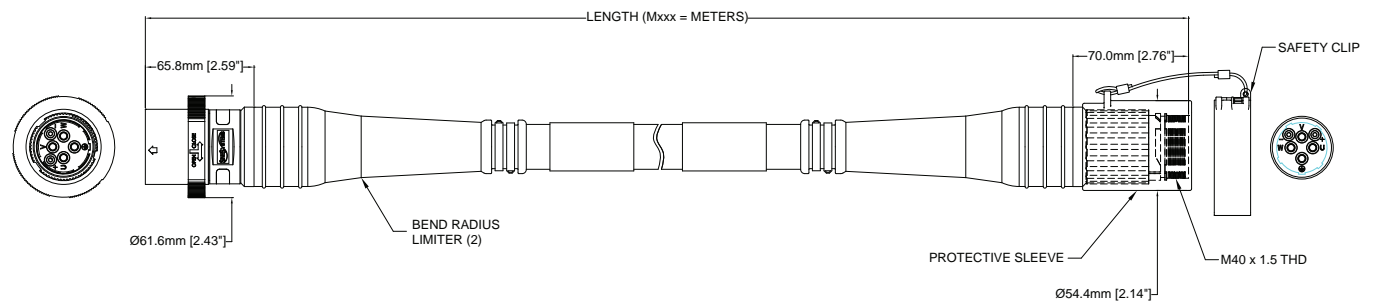

**FIG 4: Male, Straight, Receptacle**

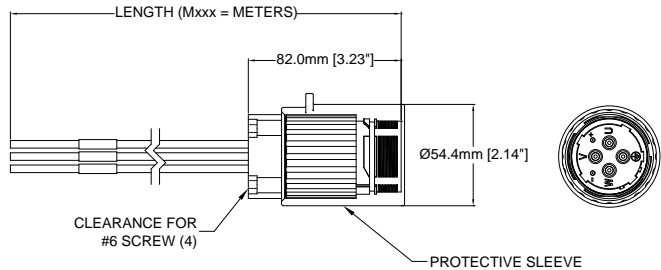

**FIG 5: Female, Straight, Receptacle**

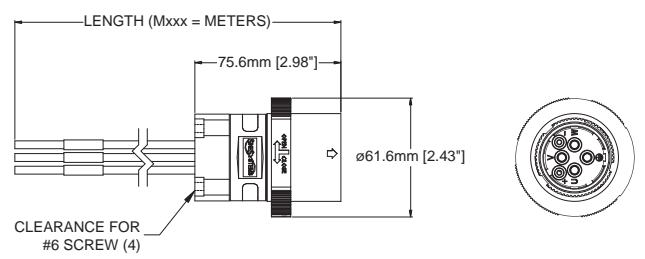

**FIG 6: Male, 10AWG, Receptacle w/ M25 Threaded Adapter**

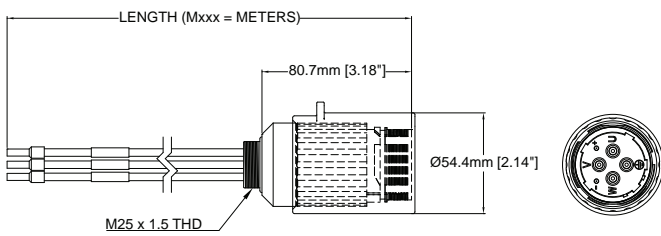

All Dimensions in: mm [inch]

## Dimensional Drawings, cont.

FIG 7: Tee, Standard, Black

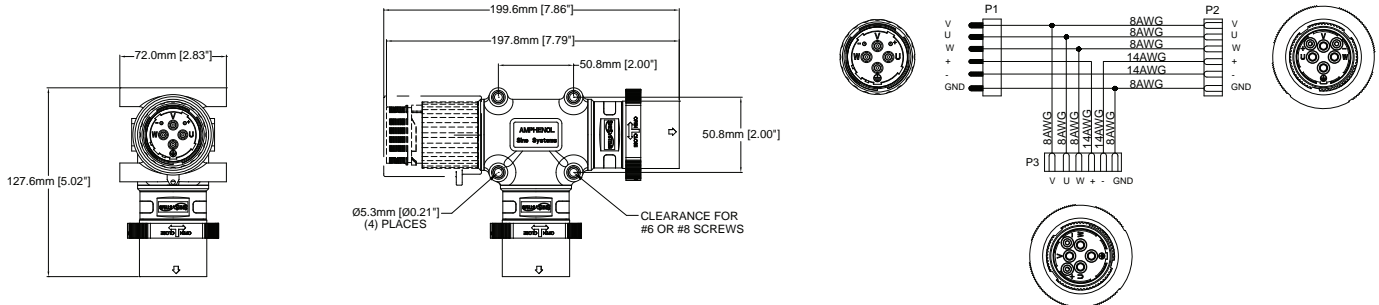
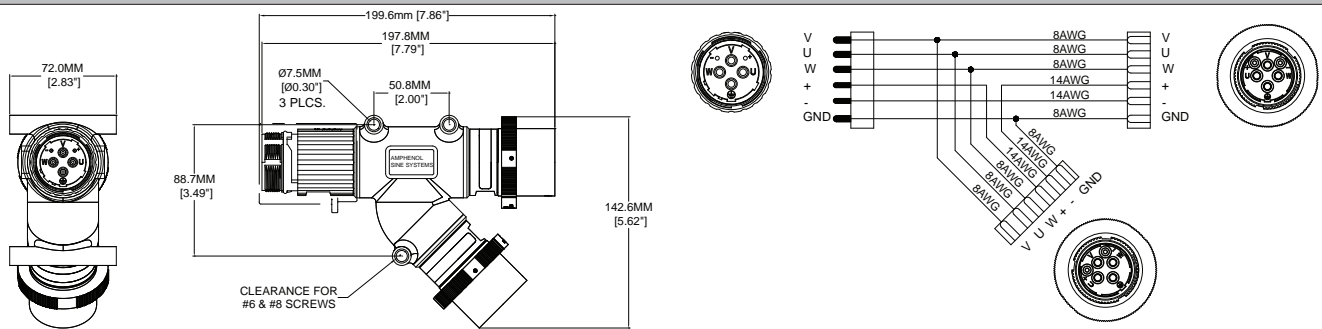

FIG 8: Tee, Angled Leg, Black



All Dimensions in: mm [inch]

This page intentionally left blank.

## M40 - 6 Position Specifications



Temperature Range	-20°C to 105°C	Dielectric Test Voltage	2200V
Coupling Nut	Machined Aluminum, Anodized	Protection	IP67 (Mated Condition)
Insulation Insert	Thermoplastic, UL 94/V-0	Mating Cycles	>500
Contact	Gold Flash Plating over Copper Alloy	Vibration Resistance	Per MIL-STD-202 Method 204
Bend Radius Limiter	Thermoplastic, Black	Thermal Shock	Per MIL-STD-202 Method 207
Cable Jacket Material	Available in PVC or TPE (See below)	48 Hour Salt Spray	Per MIL-STD-202 Method 101
Insulation Resistance	5000M OHMS	Short Circuit Rating	65kA
NFPA-79	Meets standards for motor/branch circuits		

Cable Trunk Rating Specifications				
Single-rated	PVC insulated, 10AWG stranded copper (105 x 30)	TC-ER Only UL Listed; FT-4 Flame Rating	600V, 90°C Dry/Wet	Black TPE Cable Jacket
	PVC insulated, 14AWG stranded copper (105 x 34)			
Dual-rated	PVC insulated, 8AWG stranded copper (7 x 19 x 29)	TC-ER Only UL Listed; FT-4 Flame Rating	600V, 90°C Dry/Wet	Black TPE Cable Jacket
	PVC insulated, 14AWG stranded copper (105 x 34)			
Dual-rated	PVC insulated, 10AWG stranded copper (105 x 30)	TC-ER/STOOW; UL listed; FT2; CSA certified type STOOW	600V, 90°C Dry/75°C Wet (TC-ER) 105°C (STOOW)	Black PVC Cable Jacket
	PVC insulated, 14AWG stranded copper (105 x 34)			
Dual-rated	PVC insulated, 8AWG stranded copper (7 x 19 x 29)	TC-ER/STOOW; UL listed; FT2; CSA certified type STOOW	600V, 90°C Dry/75°C Wet (TC-ER) 105°C (STOOW)	Black PVC Cable Jacket
	PVC insulated, 14AWG stranded copper (105 x 34)			

The Industrial@Amphenol products found within this section are UL 2237 Listed for the amperage ratings provided. However, for higher amperage requirements with governances outside of this specific UL listing, please consult your salesperson as higher amperage values may be applicable.

## M40 - 6 Position Cable Assemblies

Mxxx = length in meters

	6 Pos.; 600V; Power 32A, Signal 5A	6 Pos.; 600V; Power 25A, Signal 5A	6 Pos.; 600V; Power 20A, Signal 5A
Color Code (Ref. Pg 34)	U - Black, V - Black, W - Black, Ground - Green, "+" - Blue, "-" - Blue, Shield		
Number of Contacts	4C <b>8AWG</b> x 1 Shielded 14AWG Pair	4C <b>10AWG</b> x 1 Shielded 14AWG Pair	4C <b>12AWG</b> x 1 Shielded 14AWG Pair
Cable O.D.	27.7 (1.09)	24.0 (0.945)	11.7 (.46)
Male Straight, Female Straight, Dual-rated (See FIG 1, Pg 44)	 P29844-Mxxx	 P29950-Mxxx	
Male Straight/Female HAN Q4/2, Single-rated (See FIG 2, Pg 44)  *UL Approval Pending As An Assembly			 P30066-Mxxx

## M40 - 6 Position Receptacles

Mxxx = length in meters

	6 Po.; 600V; 32A Power, 5A Signal	
Color Code (Ref. Pg 34)	U - Black, V - Black, W - Black, Ground - Green, "+" - Blue, "-" - Blue, Shield	
Number of Contacts	4C <b>8AWG</b> x 2 Conductor 14AWG	4C <b>8AWG</b> x 2 Conductor 14AWG (w/ 8AWG Leads)
Female Straight (See FIG 3, Pg 44)	 P29848-Mxxx	 P29954-Mxxx

## M40 - 6 Position Tees

	6 Pos.; 600V; 32A Power, 5A Signal
Standard, Black (See FIG 4, Pg 44)	 P29841

M40 - Accessories

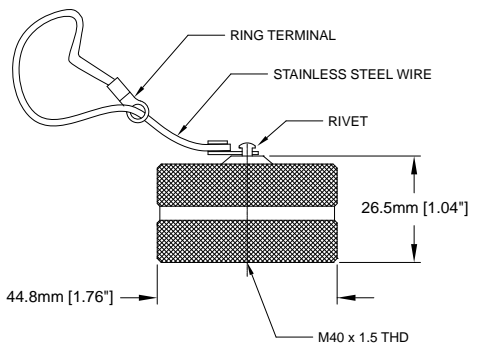
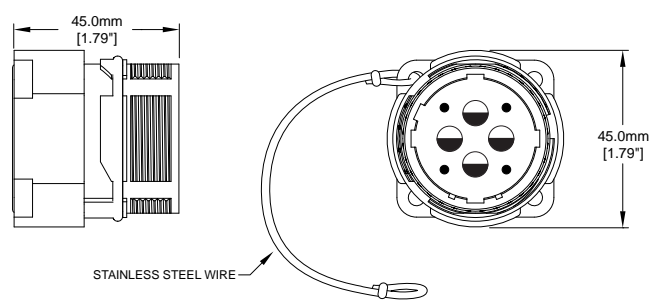
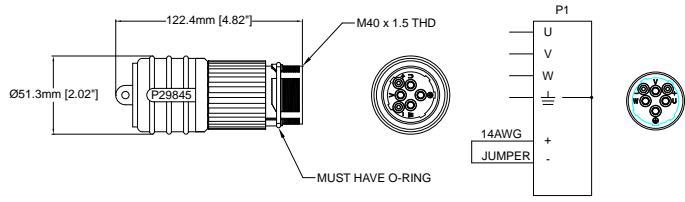
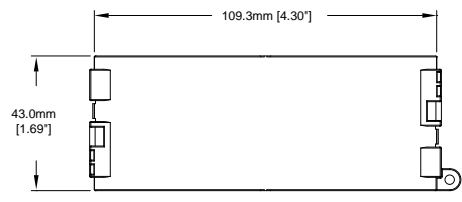
M40, Dustcap for Male Connector	P29851	M40, "Potted" Dustcap for Female Connector	P30510
			
M40, 6 Pos., Terminator Plug	P29845	M40, Locking Ring w/ Lanyard	P29850
			

All Dimensions in: mm [inch]

## Dimensional Drawings

**FIG 1: Male to Female, Plug, Straight, 6 Position**

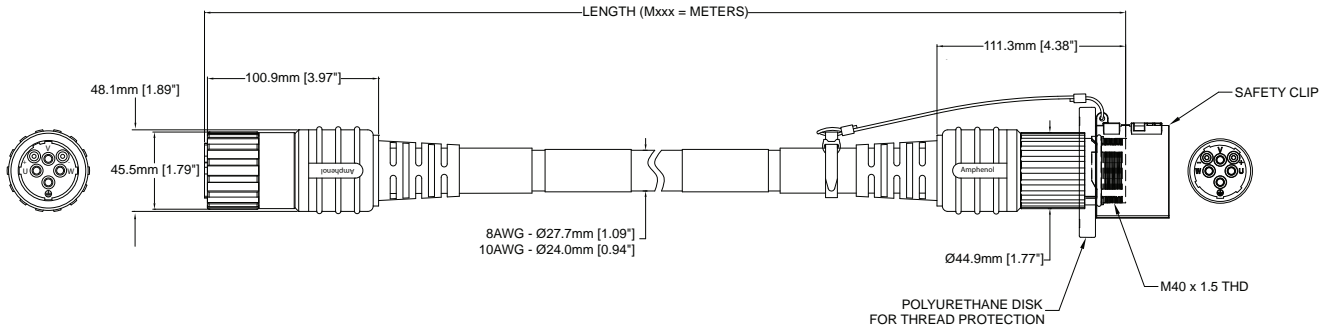

**FIG 2: Male Plug to HAN Q4/2 Female Plug**

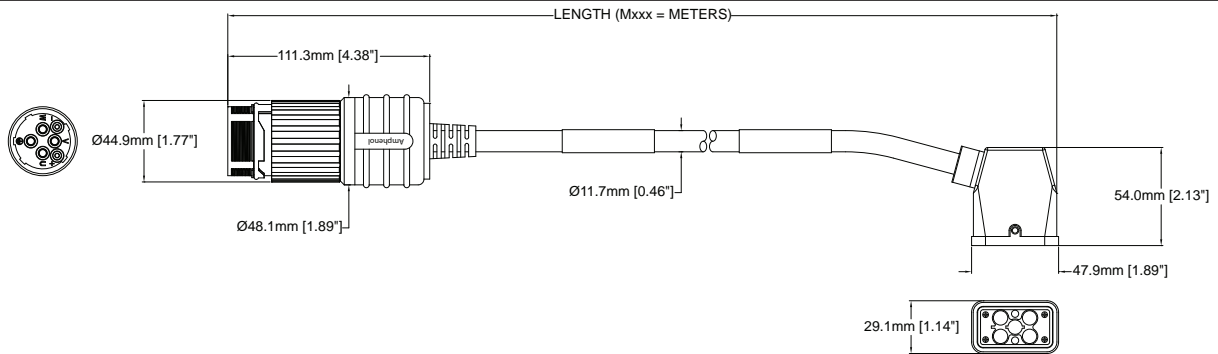

**FIG 3: Female, Straight, Receptacle**

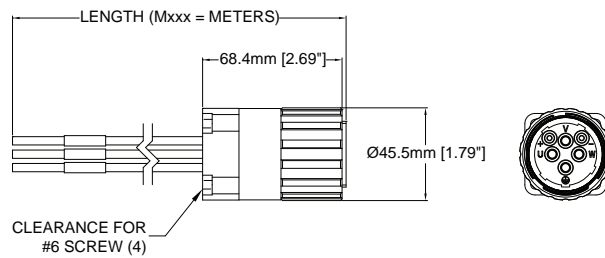

**FIG 4: Tee, Standard, Black**

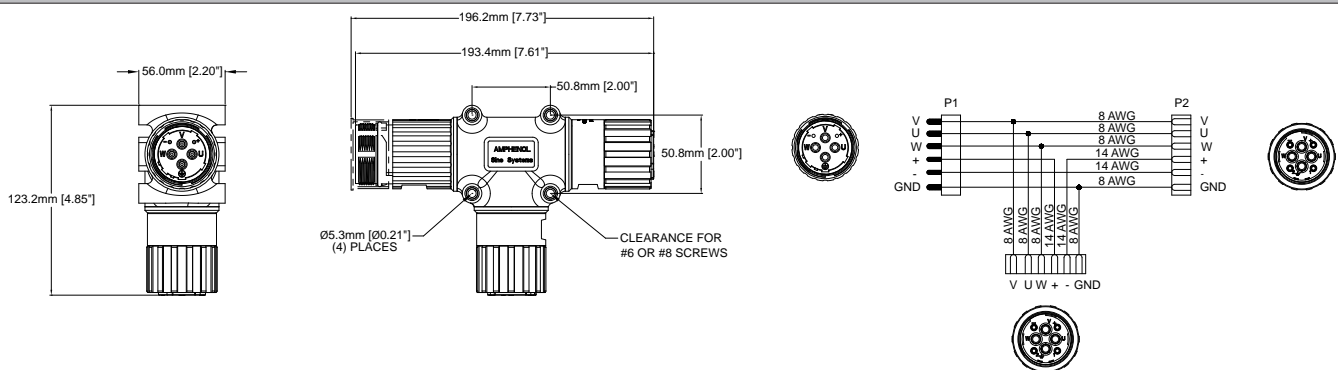

All Dimensions in: mm [inch]

This page intentionally left blank.



# PowerBOSS™

Power & Control Distribution System



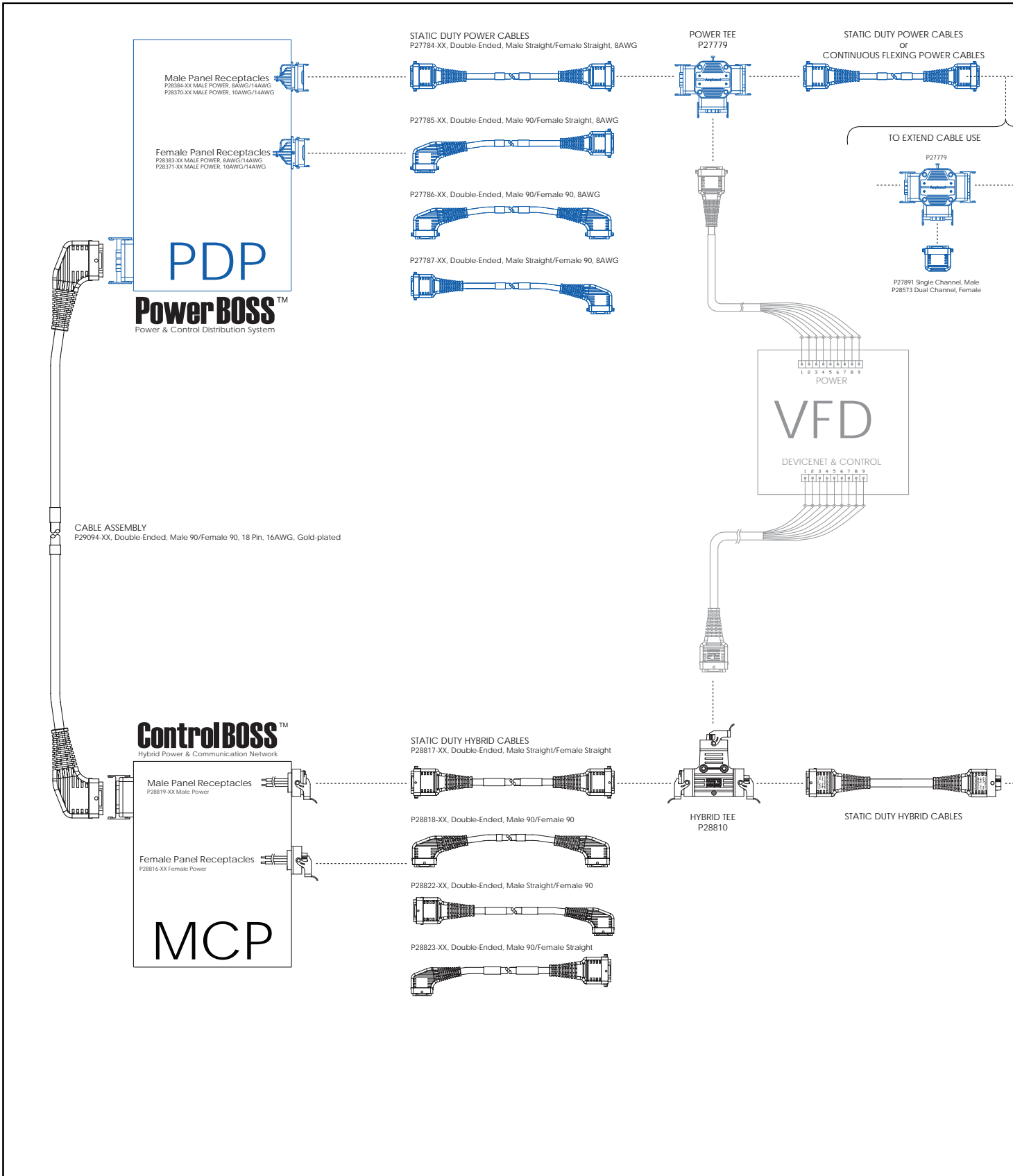

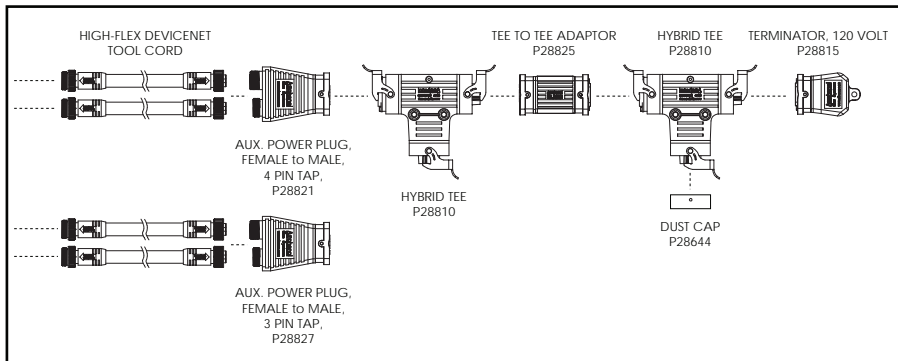
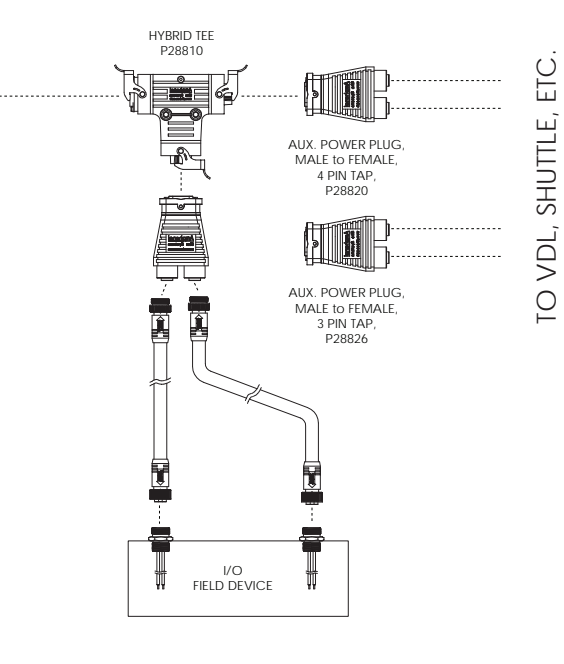
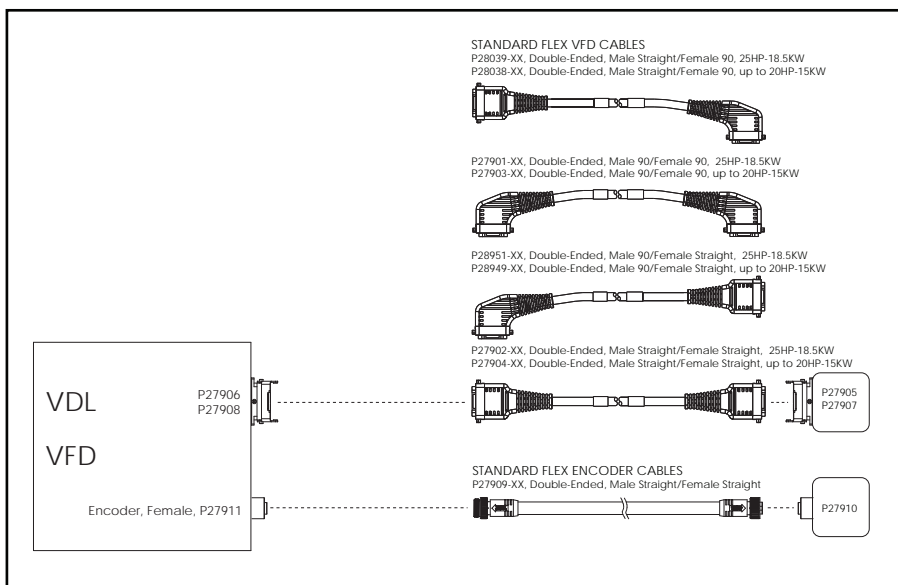
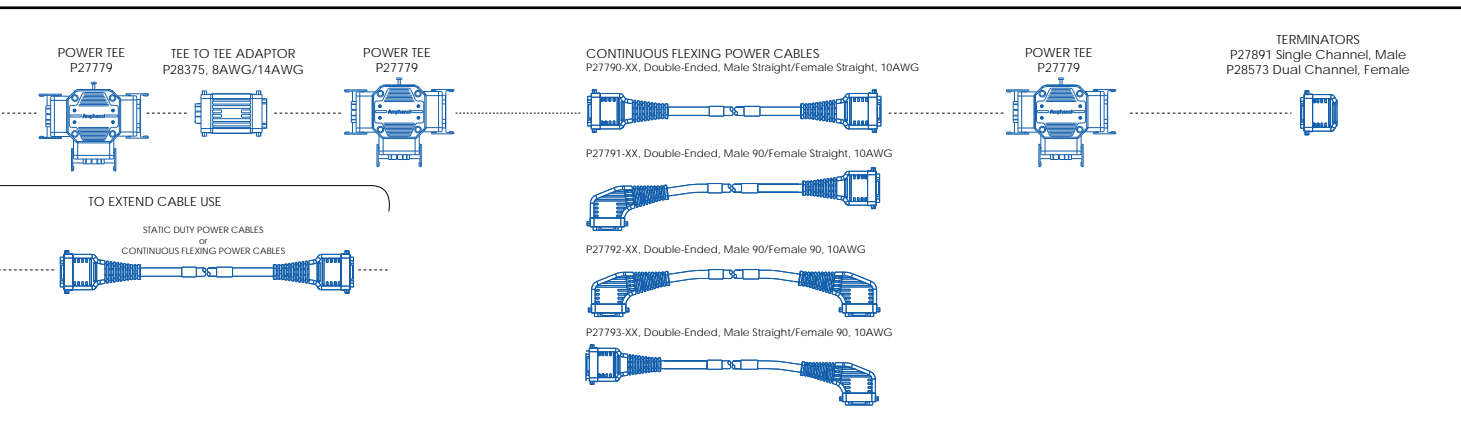

PowerBOSS™ and ControlBOSS™  
Typical Architecture

**INDUSTRIAL@AMPHENOL**  
TRUSTED GLOBALLY

Amphenol Sine Systems

# PowerBOSS™



The PowerBOSS™ System includes 4 primary conductors and 2 individually shielded pairs of 14AWG. One pair is typically used as a cable connection monitor and is connected to a single channel safety relay which controls redundant contactors in case someone has removed the locking device and disconnects the cable. The safety relay will de-energize the cable before the power contacts are open ensuring no arc flash occurs.

The second pair of conductors are typically used for dual-channel safety operations, or can be defined by the user. Both pairs are 100% shielded from the power so that no induction can occur.

- 600V/40A • Easy 'Plug & Play' Installation • Scalable • Easy to Repeat
- Faster Install & Labor Times • Faster to Market Time • Less Downtime
- Increased Worker Productivity • Elimination of Specialized Tooling
- Reduced Maintenance, Manufacturing and Labor Costs
- Delivers power through buss and drop connectors in 8-12AWG

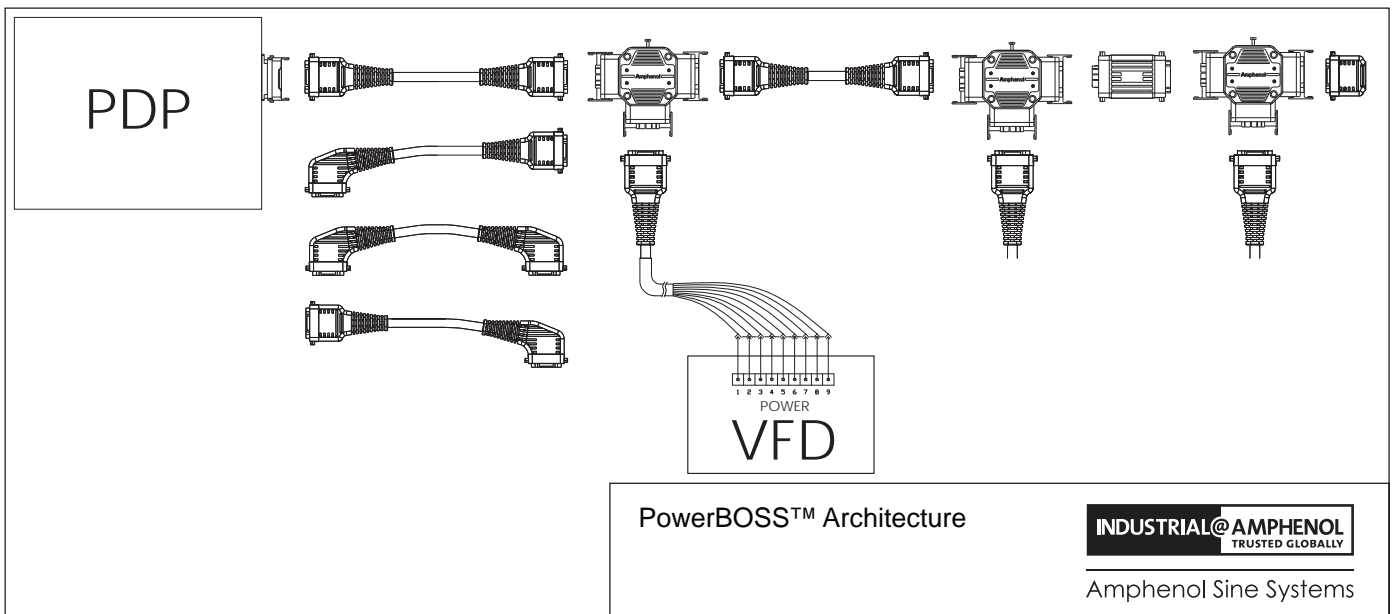

PowerBOSS™ Architecture



Amphenol Sine Systems

## PowerBOSS™ Specifications

Two stage over-molded cable assemblies	Strong Thermoplastic 9 Pin contact housing
Oil and chemical resistant PVC jacket and molding compounds	UL and CSA listed; UL Type TC-ER
IP65 fluid resistant	CSA AWM I/II A/B, 600 Volt FT4
Uni-Directional cable strain relief	600 Volt AC
Vibration resistant coupling system	Open wiring rated
Silver and gold plated contact offering	Operating temperature - 25°C to 90°C
Heavy duty aluminum die cast shell	Stationary and continuous flexing cable options



## 9 Position Cable Assemblies and Receptacles

Exxx = length in feet  
Mxxx = length in meters

9 Pos.; 600V; 40A Power, 10A Signal	
Wiring Diagram	
Number of Contacts	3/4 + PE + Shield
Cavities 6-9	Cavities 6-9 contacts are last mate/first break. Cavity 2 contact is first mate/last mate ground

Static Plugs	See FIG/Page	8-14AWG	10-14AWG
Male Str/Female Str	FIG 1, Pg 52	P27784-Mxxx	P28559-Mxxx
Male 90°/Female Str	FIG 2, Pg 52	P27785-Mxxx	P28560-Mxxx
Male Str/Female 90°	FIG 3, Pg 52	P27787-Mxxx	P28562-Mxxx
Male 90°/Female 90°	FIG 4, Pg 52	P27786-Mxxx	P28561-Mxxx

Continuous Flex Plugs	See FIG/Page	8-14AWG	10-14AWG
Male Str/Female Str	FIG 1, Pg 52	-	P27790-Mxxx
Male 90°/Female Str	FIG 2, Pg 52	-	P27791-Mxxx
Male Str/Female 90°	FIG 3, Pg 52	-	P27793-Mxxx
Male 90°/Female 90°	FIG 4, Pg 52	-	P27792-Mxxx

Panel Receptacles	See FIG/Page	8-14AWG	10-14AWG
Male Power	FIG 5, Pg 52	P27797-Mxxx	P28572-Mxxx
Female Power	FIG 6, Pg 52	P27796-Mxxx	P28571-Mxxx



### Tees

Description	See FIG/Page	Part Number
Power Tee, 9 Pos., 600V	FIG 7, Pg 53	P27779
Dual Channel Tee, 9 Pos., 600V	FIG 8, Pg 54	P28574



### Tea to Tee Adaptor

Description	See FIG/Page	Part Number
Male to Female, 9 Pos., 8/14AWG	FIG 9, Pg 55	P28375



### 9 Position Terminators

Description	See FIG/Page	Part Number
Single Channel, Male, 9 Pos.	FIG 10, Pg 55	P27891
Dual Channel, Male, 9 Pos.	FIG 11, Pg 55	P28573



### Dimensional Drawings

P28625, Male Straight Plug to Cord Grip, 10AWG, Static, 9 Position

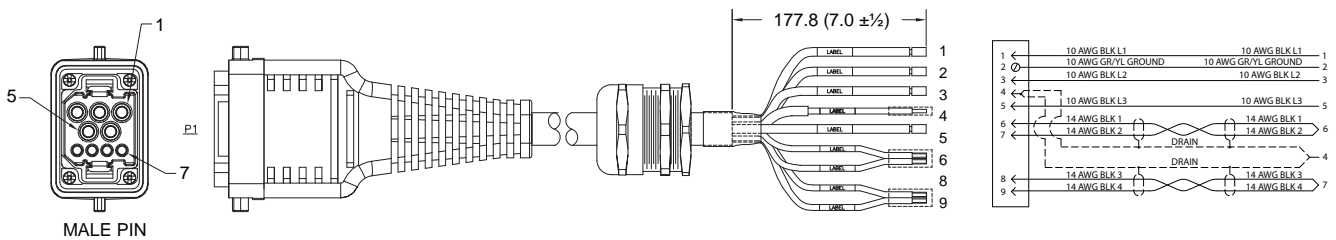

Dimensional Drawings, cont.

FIG 1: Male Straight to Female Straight, Plug, 9 Position

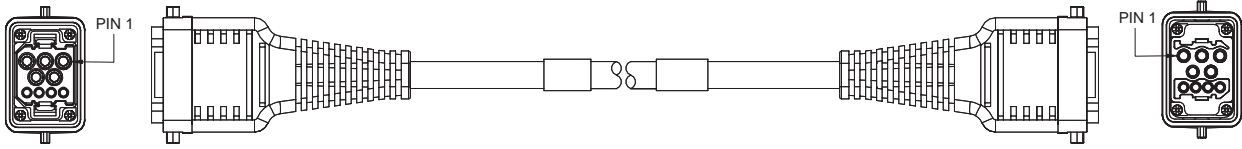

FIG 2: Male 90° to Female Straight, Plug, 9 Position

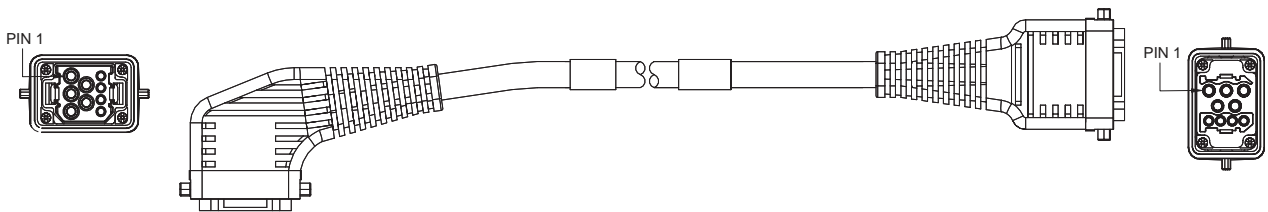

FIG 3: Male Straight to Female 90°, Plug, 9 Position

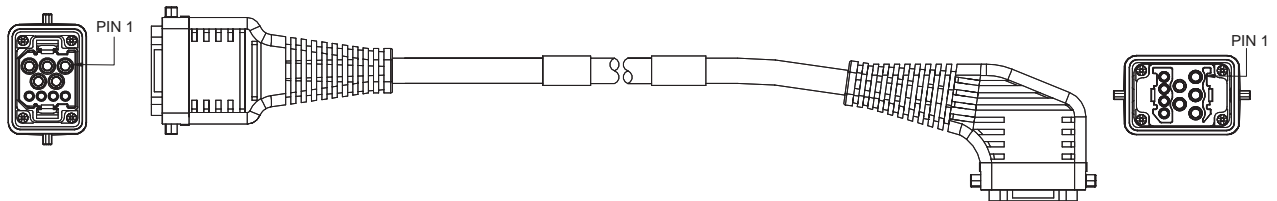

FIG 4: Male 90° to Female 90°, Plug, 9 Position

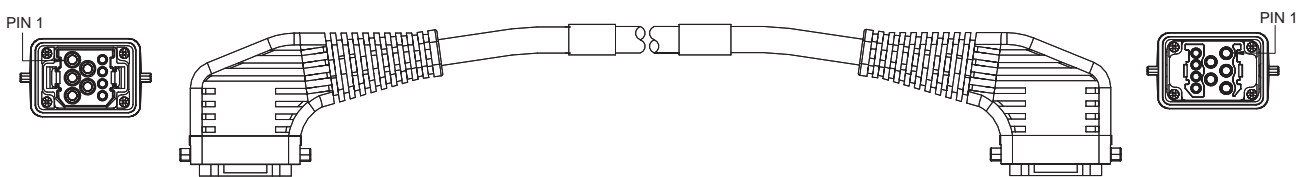

FIG 5: Male Power, Straight, Receptacle

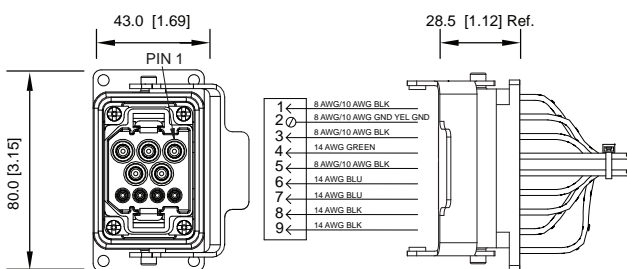
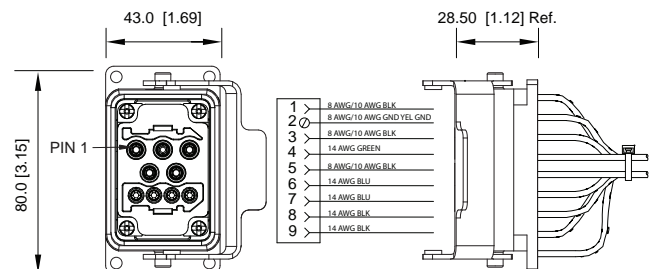

FIG 6: Female Power, Straight, Receptacle



All Dimensions in: mm [inch]

Dimensional Drawings, cont.

FIG 7: Power Tee, 600V, 9 Position

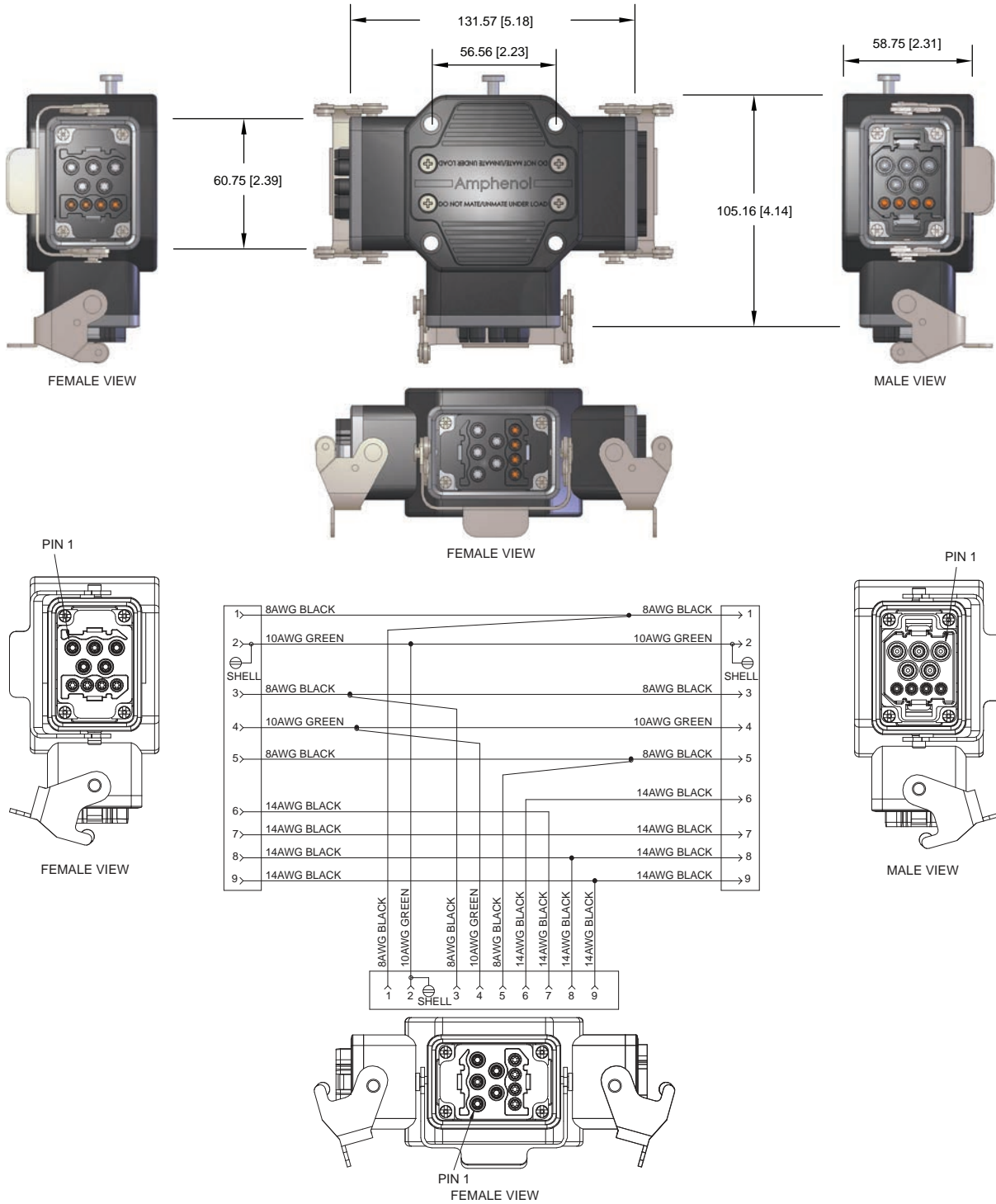

All Dimensions in: mm [inch]



Dimensional Drawings, cont.

FIG 8: Dual Channel Tee, 600V, 9 Position

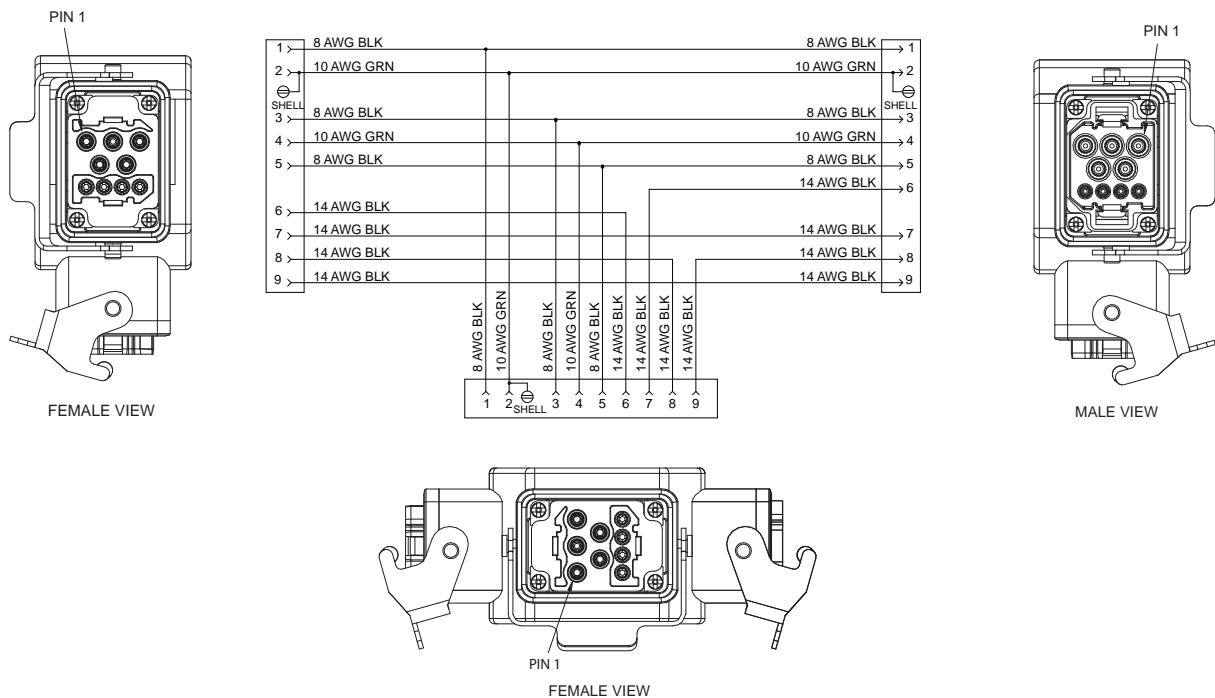
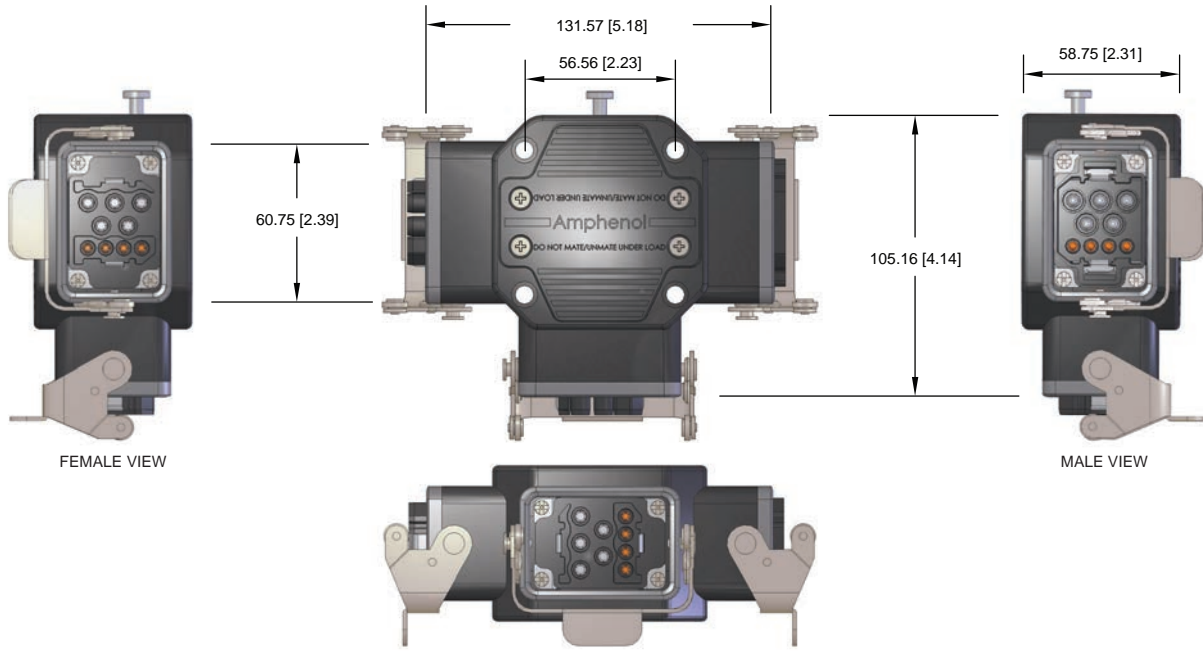

All Dimensions in: mm [inch]

Dimensional Drawings, cont.

FIG 9: Tee to Tee Adaptor, 9 Position

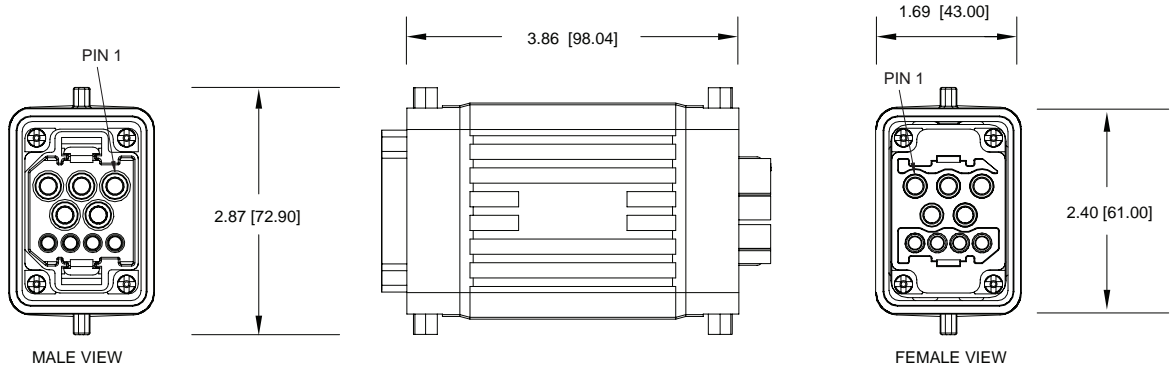

FIG 10: Male, Single Channel, Terminator, 9 Position

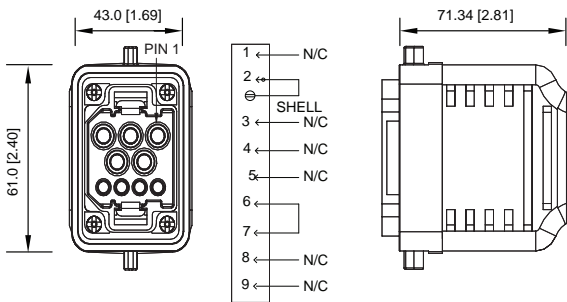
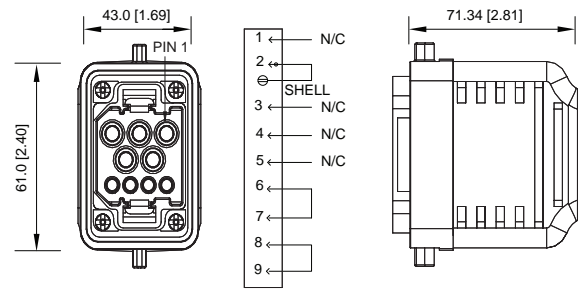

FIG 11: Male, Dual Channel, Terminator, 9 Position



## Cable Specifications and Part Numbers

8 and 10AWG Static Cable	10AWG High Flex Cable

**Applications:**

- Factory Equipment Interconnects
- Machine Tools
- Control Panels
- Conveyor Systems
- Automotive Assembly Equipment
- Stationary Track/Tray

**Specifications:**

- UL Type TC-ER (600V)
- CSA AWM II A/B 600V FT4

**Characteristics:**

- Operating Temperature Range: -25°C to 90°C
- Voltage Rating: 600V
- Conductor: **8 AWG**
  - 4 x 8 AWG
  - 4 x 14 AWG + Shield
- 10 AWG**
  - 4 x 10 AWG
  - 4 x 14 AWG + Shield

**Applications:**

- High Flexibility/High Bend Applications
- Factory Equipment Interconnects
- Machine Tools
- Flex and Static Track
- Transfer Shuttles

**Specifications:**

- UL Type TC (600V)
- CSA AWM II A/B 600V FT4

**Characteristics:**

- Operating Temperature Range: -10°C to 70°C
- Voltage Rating: 1000V
- Conductor: **10 AWG**
  - 4 x 10 AWG
  - 4 x 16 AWG + Shield

Description	Part Number	*Nominal O.D.	*Minimum Bend Radius
PowerBOSS™ Power Cable 8AWG	KA-53136	0.971	6.80
PowerBOSS™ Power Cable 10AWG	KA-56149	0.810	5.67
PowerBOSS™ Power Cable 10AWG High Flex	KA-56293	0.88	6.6

\* Measurements In Inches.

This page intentionally left blank.

# ControlBOSS™

Hybrid Power & Communication Network

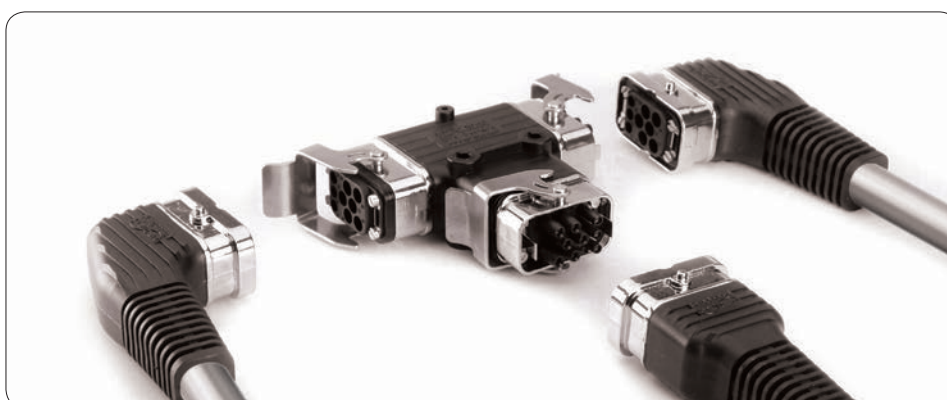
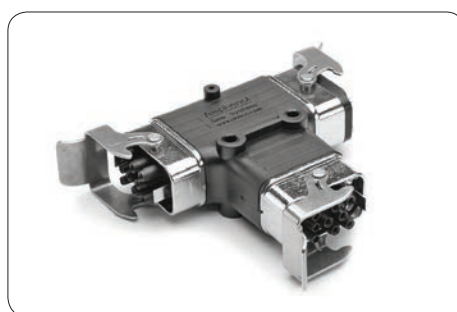

# ControlBOSS™

ControlBOSS™

ControlBOSS™ is the compilation of the industry standard DeviceNet™ and 2 additional circuits. These circuits can be used as additional power to the current DeviceNet™ node power or can be user definable. As an example, the additional circuits could be used to refresh the DeviceNet™ node power or provide additional field input/output power. With this approach, both the DeviceNet™ communication network and additional control can be installed at the same time within one cable thus reducing field installation time and money.

- 600V/15A (Power), 5A (Signal) • 'Plug & Play' Installation • Scalable • Easy to Repeat
- Faster Install & Labor Times • Faster to Market Time • Less Downtime
- Increased Worker Productivity • Elimination of Specialized Tooling
- Reduced Maintenance, Manufacturing and Labor Costs
- Delivers power through buss and drop connectors in 8-12AWG

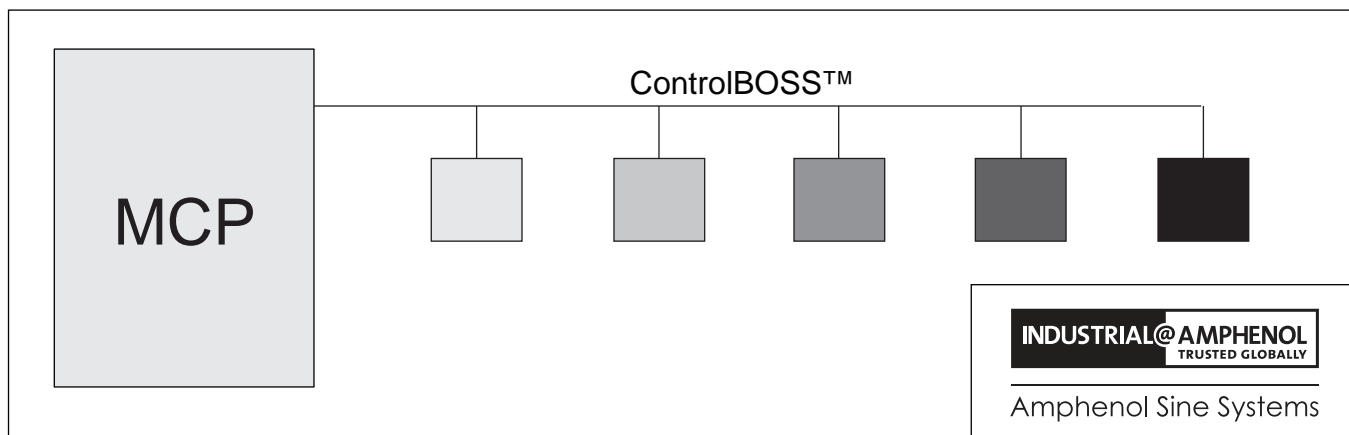
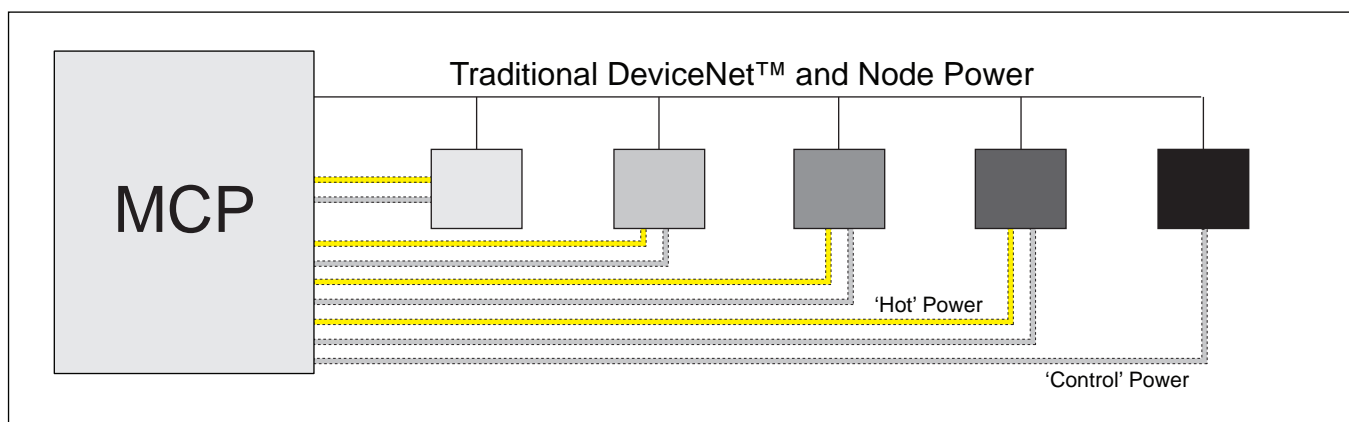

## ControlBOSS™ Specifications

Two stage over-molded cable assemblies	Strong Thermoplastic contact housing
Oil and chemical resistant PVC jacket and molding compounds	UL and CSA listed; UL Type TC-ER
IP65 fluid resistant	UL Type TC-ER 600V Class I
Uni-Directional cable strain relief	Open wiring rated, compliant to NEC sec. 725.61 (0)(4) and NEC sec. 336.10
Vibration resistant coupling system	Operating temperature – 25°C to 90°C
Gold-plated contacts	Unlimited custom length options
Heavy duty nickel-plated aluminum die cast shell	



## 9 Position Cable Assemblies and Receptacles

Exxx = length in feet  
Mxxx = length in meters

		9 Position; 600V; 15A Power, 2A Signal	
Wiring Diagram			
Number of Contacts		6/3 + PE	
Cavities 6-9		Cavities 6-9 contacts are last mate/first break. Cavity 2 contact is first mate/last mate ground	

Static Hybrid Cables	See FIG/Page	14-18AWG
Male Str/Female Str	FIG 1, Pg 62	P28817-Mxxx
Male 90°/Female Str	FIG 2, Pg 62	P28823-Mxxx
Male Str/Female 90°	FIG 3, Pg 62	P28822-Mxxx
Male 90°/Female 90°	FIG 4, Pg 62	P28818-Mxxx

Panel Receptacles	See FIG/Page	14-18AWG
Male Power	FIG 5, Pg 62	P28819-Mxxx
Female Power	FIG 6, Pg 62	P28816-Mxxx

### Hybrid Tee

Description	See FIG/Page	Part Number
Hybrid Tee, 9 Pos., 600V	FIG 7, Pg 63	P28810

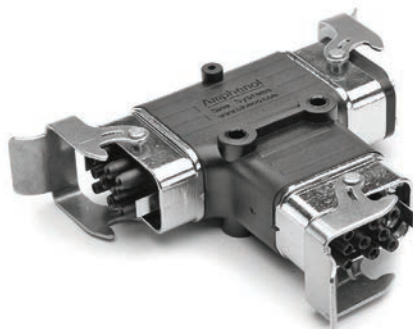

### Tee to Tee Adaptor

Description	See FIG/Page	Part Number
Male to Female, 9 Pos., 14/18AWG	FIG 8, Pg 64	P28825



### Auxilliary Power Plugs

Description	See FIG/Page	Part Number - 3 Pos.	See FIG/Page	Part Number - 4 Pos.
Male/Female	FIG 10, Pg 64	P28826	FIG 12, Pg 65	P28820
Female/Male	FIG 11, Pg 64	P28827	FIG 13, Pg 65	P28821



### Terminator Plug

Description	See FIG/Page	Part Number
Terminator, Male, 120V	FIG 9, Pg 64	P28815





## Dimensional Drawings

FIG 1: Male Straight to Female Straight, Plug, 9 Position

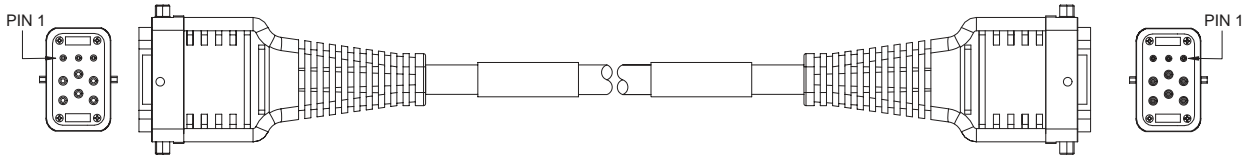

FIG 2: Male 90° to Female Straight, Plug, 9 Position

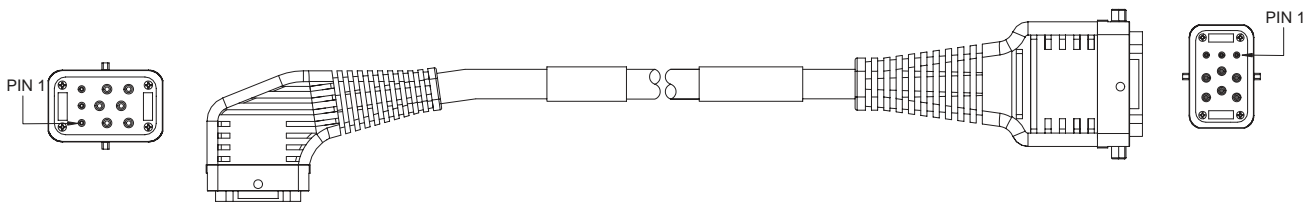

FIG 3: Male Straight to Female 90°, Plug, 9 Position

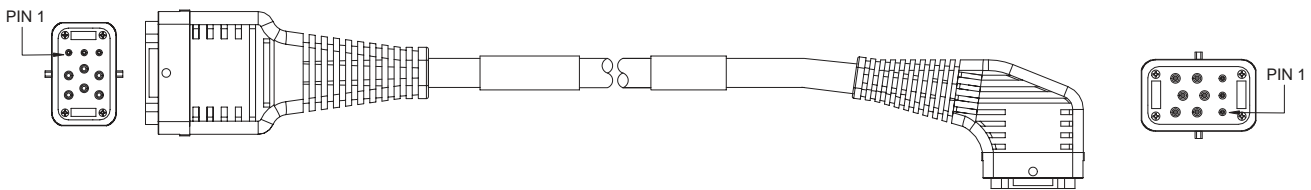

FIG 4: Male 90° to Female 90°, Plug, 9 Position

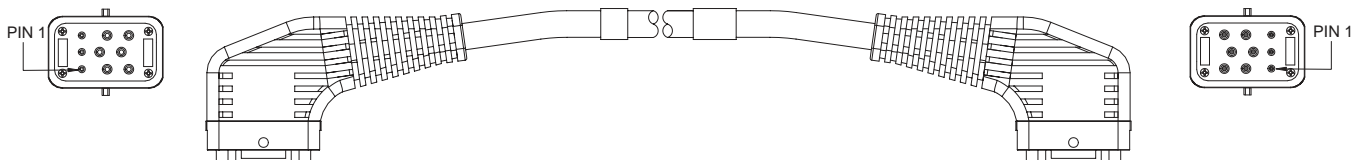

FIG 5: Male Power, Receptacle, Straight, 9 Position

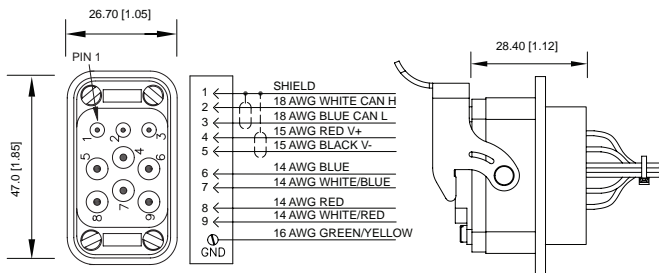
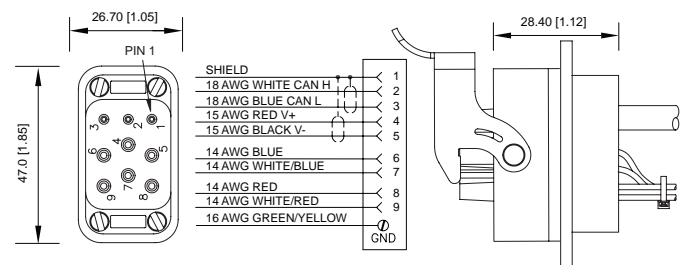

FIG 6: Female Power, Receptacle, Straight, 9 Position



All Dimensions in: mm [inch]

Dimensional Drawings, cont.

FIG 7: Hybrid Tee, 600V, 9 Position

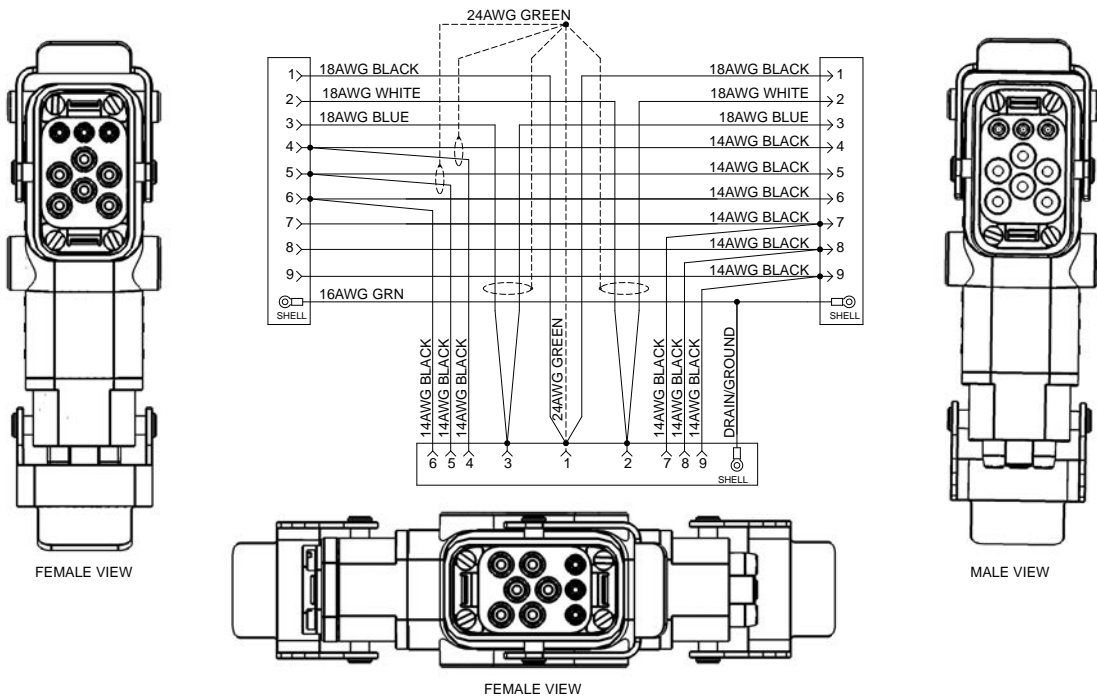
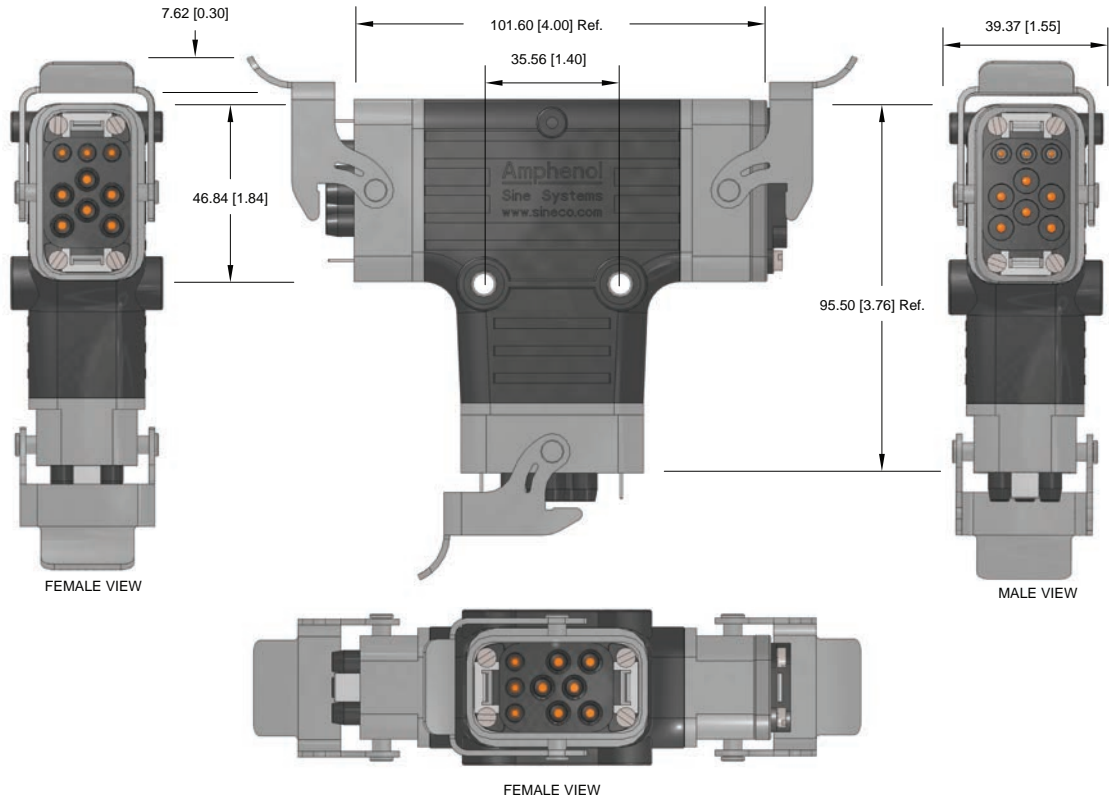

All Dimensions in: mm [inch]

Dimensional Drawings, cont.

FIG 8: Tee to Tee Adaptor, 9 Position

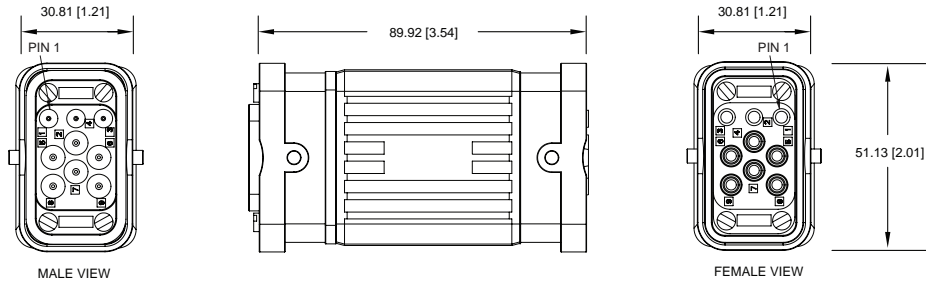

FIG 9: Male, 120V, Terminator, 9 Position

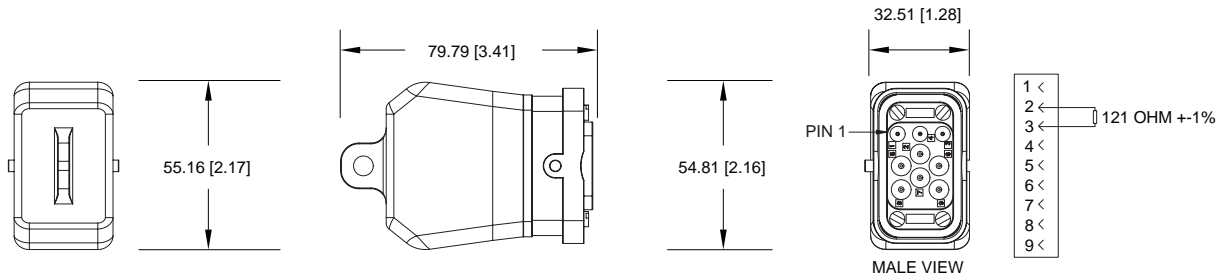

FIG 10: Male to Female, 3 Pin Tap, 9 Position

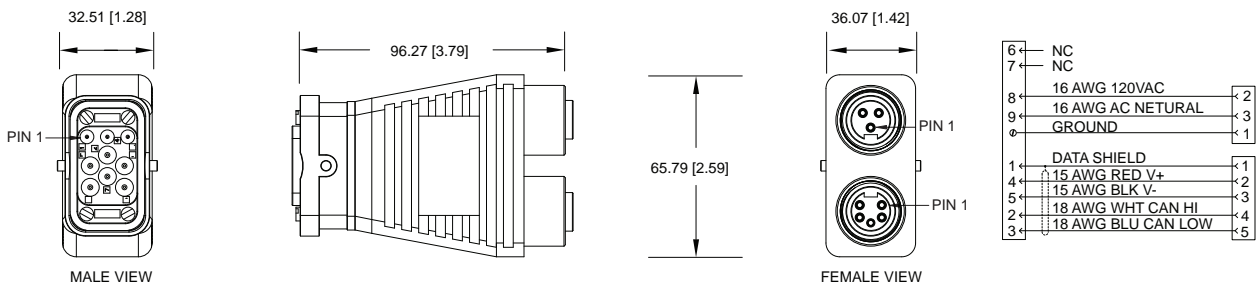
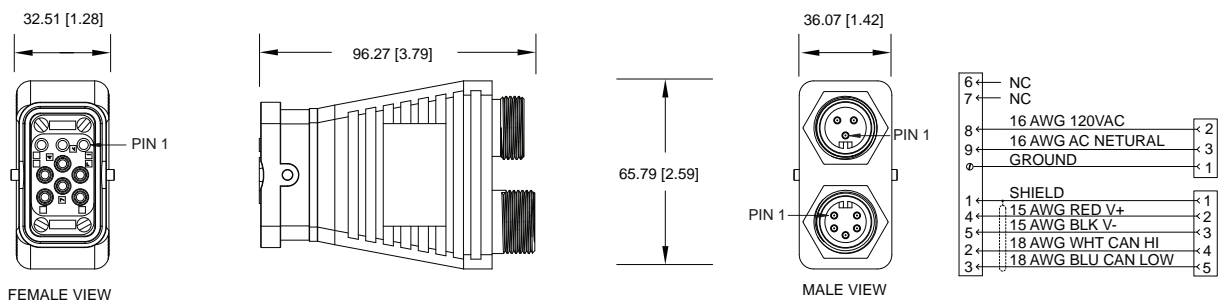

FIG 11: Female to Male, 3 Pin Tap, 9 Position



All Dimensions in: mm [inch]

Dimensional Drawings. cont.

FIG 12: Male to Female, 9 Pos., 4 Pin Tap

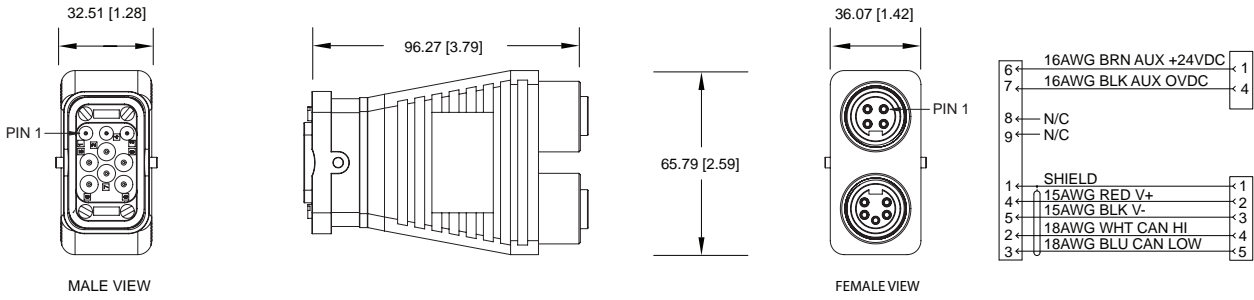
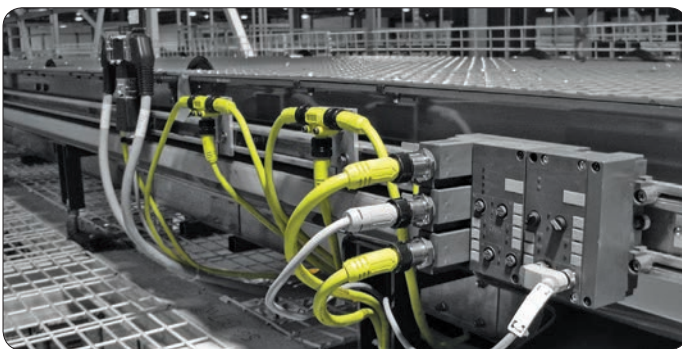
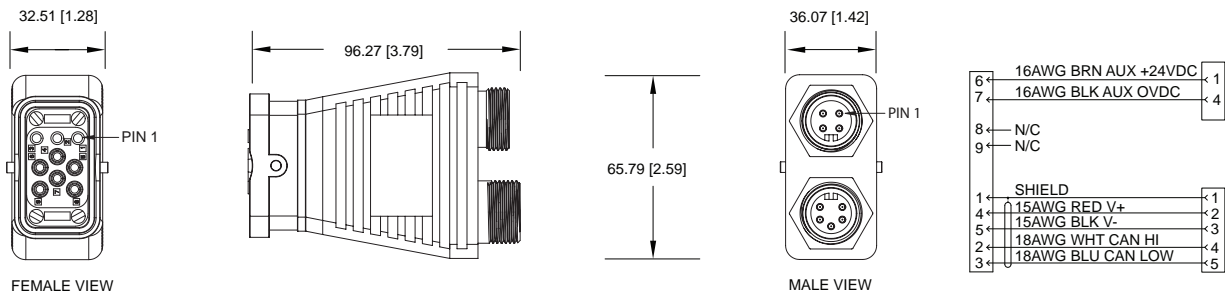

FIG 13: Female to Male, 9 Pos., 4 Pin Tap



All Dimensions in: mm [inch]

## Cable Specifications and Part Numbers

### Hybrid Cable

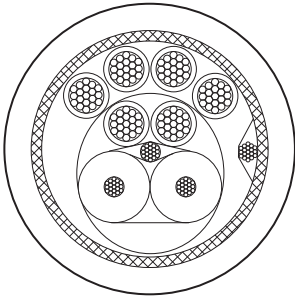

**Applications:**

- Factory Equipment Interconnects
- Machine Tools
- Control Panels
- Conveyor Systems
- Automotive Assembly Equipment

**Characteristics:**

- Operating Temperature Range: -25°C to 90°C
- Voltage Rating: 600V
- Conductor: 6 x 14AWG  
2 x 18AWG DATA + Shield

**Specifications:**

- UL Type TC-ER (600V)
- CSA AWM II A/B 600V FT4

Description	Part Number	*Nominal O.D.	*Minimum Bend Radius
ControlBOSS™ Hybrid Cable	KA-56267	0.710	7.10

\* Measurements In Inches.

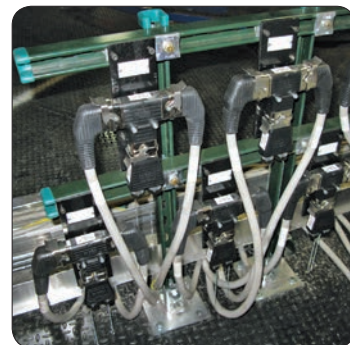

This page intentionally left blank.

# VersaBOSS™

Connector & Cable Assemblies



## VersaBOSS™

What's in a VersaBOSS™ cable? Let's start with specifically designed VFD cable which maintains outstanding radiated and conductive noise mitigation properties. The "high-strand" conductor construction not only provides greatly enhanced flexibility but also maintains robust shield and ground designs. Industrial grade PVC & TPE jackets combined with an ER rating in a "Turn-Key" system and the motor horsepower tables have now been turned in your favor. Meet VersaBOSS™.

Want more? The VersaBOSS™ has the capacity to exceed the rigors of UL 2237 "short-circuit" Withstand Test and "Distributed Branch Circuit" criteria, an ever increasing requirement from those who demand more from their VFD.

But we didn't stop there. VersaBOSS™ takes your VFD's capabilities to a different level by effectively eliminating the guesswork and subsequent missteps so common in a myriad of electrical cable options available today.

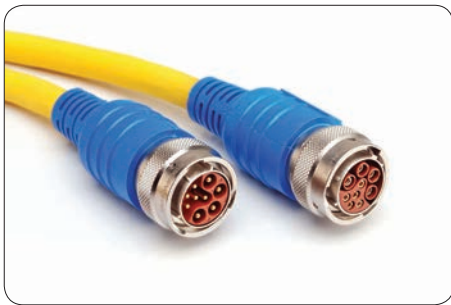

Available in High-Flex/TPE Yellow and Static/PVC Black Cable. Available in Blue, Black or Yellow overmolds.

VersaBOSS™ offers "first of its kind" connector technology in conjunction with advanced cable designs for the multifaceted demands of today's Variable Frequency Drives (VFDs). This factory-terminated and test-certified, sealed and molded cable assembly combines a world-class connector, capable of delivering up to 20A of power in tandem with available signal options in a rapid mating & compact circular design.



Color-coded thermoplastic bands for visual verification.



GuardSafe™ Clip Assemblies to prevent unmating.



- **UL cUL Approved as an Assembly:** Quickly Achieve Standard Compliance Requirements while ensuring Installation safety.
- **Sealed Cable Connections:** Prevents ingress of Dust, liquid & various other contaminants
- **Factory Installed Molded Ends:** No need for field terminations, tools, shield kits or cable gland considerations.
- **Speed of “Plug & Play” Design:** Eliminates “Hard-wiring” & costly skilled labor installation costs while increasing plant flexibility.
- **Factory Conductor Terminations:** Eliminates improper shielding techniques, mis-wires & conductor damage as a result of improper tools. While ensuring thermal stability at connection points.
- **TC “Tray Cable” & ER “Exposed Run”:** Eliminates the need for Conduit, Inter-locked or Armored cable designs.
- **Power & Signal in One:** Optimal designed integrated shielded signal pair & triad options, eliminates multiple cable pulls and mitigates subsequent cable isolation considerations.
- **Superior Performance Shielding:** Effectively control EMI/RFI radiated noise and interference to surrounding electronic devices.
- **High Conductor Stranding:** Increased vibration resistance results in stable electrical performance & flexibility within the cable race way or as exposed cable runs dressed along the structure.
- **Shell to Ground Connector Design:** Inherent features specifically designed for the VFDs grounding requirements ensure low impedance ground path which reduces potential voltage differences & potentially extends service life.
- **Industrial Grade Insulation:** Ensures lower cable capacitance & maximizes power transfer. Higher reliability reduces downtime due to cable failure.
- **Bottom-line Benefits:** System designers & integrators will save time and money through the versatility which is VersaBOSS™. Through faster commissioning and lower installed cost at start-up, residual maintenance savings and your resulting total cost of ownership will result in rapid ROI.

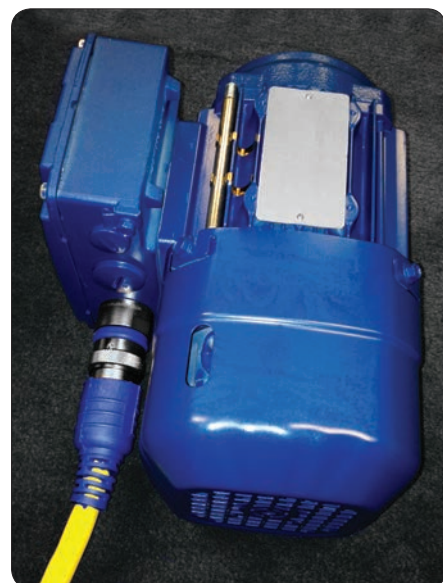

This page intentionally left blank.

## FC Hybrid - 9 Position Specifications

Housing Body	Zinc Die-cast, Nickel-plated	Insulation Resistance (Min.)	5000M OHMS
Coupling Nut	Aluminum Alloy, Nickel-plated	Dielectric Test Voltage	2200V
Wave Springs	Stainless Steel	Temperature Range	-40°C to 105°C
Insulation Insert	Thermoplastic, UL 94/V-0	Protection	IP67 (Mated Condition)
Contacts	Gold Flash-plating over Copper Alloy	Mating Cycles	>500
Seal and O-Rings	NBR (Nitrile Butadiene Rubber)	Vibration Resistance	Per MIL-STD-202 Method 204
Overmold Material	Polyurethane	Thermal Shock	Per MIL-STD-202 Method 207
Cable Jacket Material	High Flex: TPE, Yellow; Static: PVC, Black	48 Hour Salt Spray	Per MIL-STD-202 Method 101



## FC Hybrid - 9 Position Cable Assemblies

Mxxx= length in meters

9 Position; 600V Power; 30V Signal (Up to 20A Power, 5A Signal); Keying Position - W	
Wiring Diagram	<p><b>Wiring Diagram</b></p> <p><b>MALE FACE VIEW</b></p> <p><b>FEMALE FACE VIEW</b></p> <p>Pin A: BLACK 16AWG                  Pin B: BLACK 16AWG                  Pin C: BLACK 16AWG                  Pin D: GREEN/YELLOW 16AWG                  Pin E: BLUE 16AWG                  Pin H: WHITE 16AWG                  Pin L: RED 16AWG                  Pin G: BLACK 18AWG                  Pin F: BLACK 18AWG                  SHIELD: SHIELD</p>
Number of Contacts	(7) 16AWG, (2) 18AWG
Cable Type	High-Flex, TPE, Yellow Jacket      Static, PVC, Black Jacket
Male Straight, Single-rated, Blue Overmold <i>(See FIG 1, Pg 75)</i>	<p>P30710-Mxxx      P30712-Mxxx</p>
Female Straight, Single-rated, Blue Overmold <i>(See FIG 2, Pg 75)</i>	<p>P30711-Mxxx      P30713-Mxxx</p>
Male/Female Straight, Single-rated, Blue Overmold <i>(See FIG 3, Pg 75)</i>	<p>P30538-Mxxx      P30619-Mxxx</p>

## FC Hybrid - 9 Position Receptacles

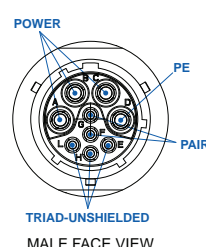
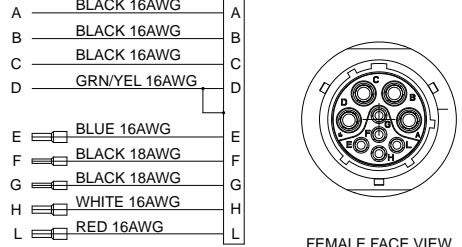
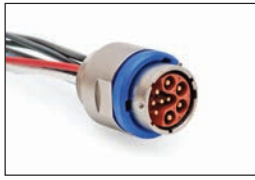
Exxx = length in feet, Hxxx = length in inches

9 Position: 600V Power; 30V Signal (Up to 20A Power, 5A Signal); Keying Position - W	
Wiring Diagrams	 
Number of Contacts	(7) 16AWG, (2) 18AWG
Type	Male <span style="margin-left: 200px;">Female</span>
Blue Color Band <i>(See FIG 4 and 5, Pg 76)</i>	 <span style="margin-left: 200px;"></span>
	<p style="text-align: center;">P30540- (Select either -Exxx or -Hxxx)</p> <p style="text-align: center;">P30539- (Select either -Exxx or -Hxxx)</p>

## Dimensional Drawings

**FIG 1: Male, Plug, Straight, 9 Position**

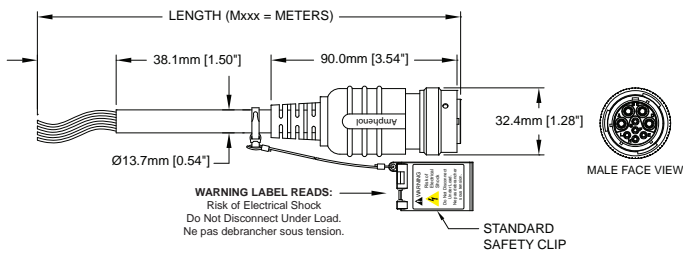

**FIG 2: Female, Plug, Straight, 9 Position**

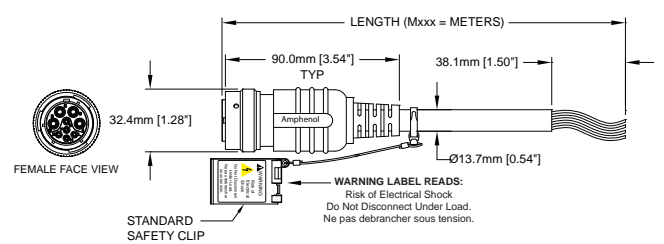

**FIG 3: Male to Female, Plug, Straight, 9 Position**

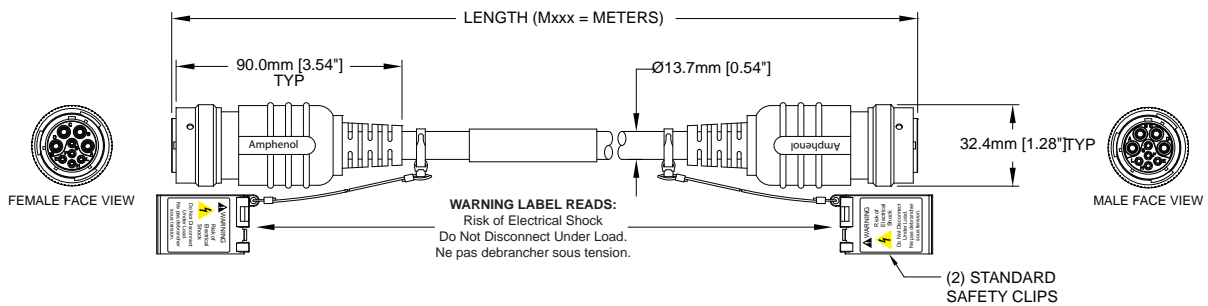

All Dimensions in: mm [inch]

Dimensional Drawings, cont.

FIG 4: Male, Receptacle, Straight, 9 Position

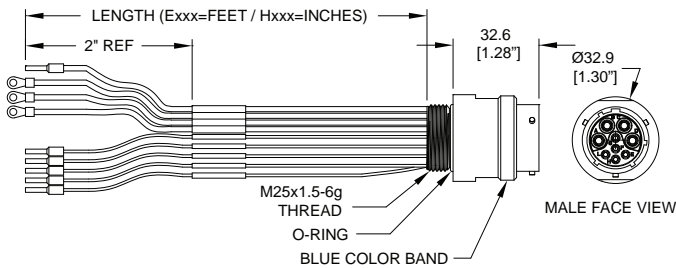
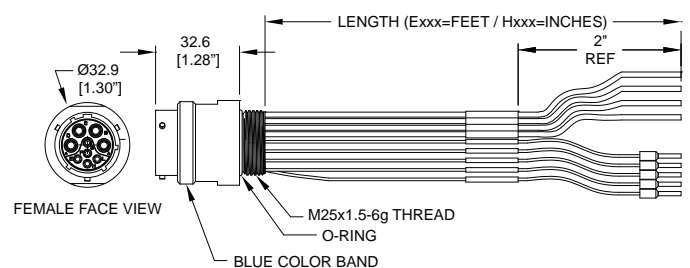
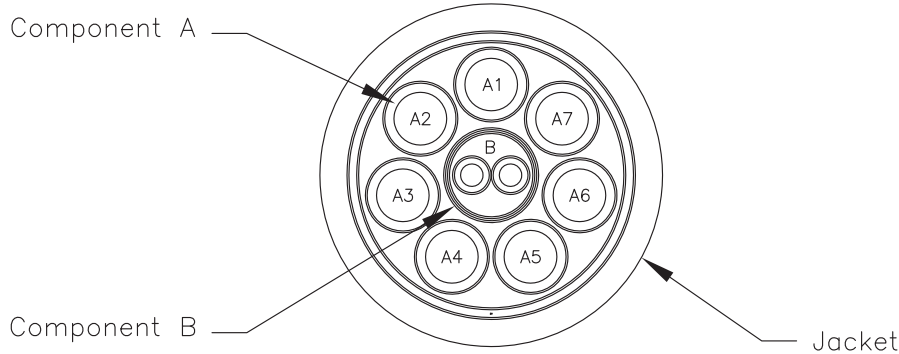

FIG 5: Female, Receptacle, Straight, 9 Position



All Dimensions in: mm [inch]



**1.0 Component A – 16 AWG**

16 AWG: Bare Copper  
Insulation: PVC  
Jacket: Clear Nylon

**2.0 Component B – Shielded Pair – 18 AWG**

18 AWG: Bare Copper  
Insulation: PVC  
Jacket: Clear Nylon  
Pair: (2) Conductors Cabled Together  
Binder: PTFE Tape  
Shield: Tinned Copper Braided Shield, 90% Coverage  
Separator: PTFE Tape

**3.0 Construction**

Core: (1) Component B  
Layer 1: (7) Component A and Fillers as required for roundness.  
Binder: PTFE Tape  
Shield: Tinned Copper Braided Shield, 90% Coverage  
Binder: PTFE Tape  
Jacket: TPE, Color: Yellow  
Diameter: .520" Nominal

**4.0 Print Legend**

AMPHENOL SINE SYSTEMS KA-56639 (UL File #)  
7/C 16 AWG + 1/PR 18 AWG (UL) TYPE TC-ER  
90C DRY 75C WET 600V SUN RES DIR BUR ---  
(CSA FILE #) CSA AWM I/II A/B 90C 600V FT4

**COLOR CODE**

Component	COLOR
A1	Black and printed "U1"
A2	Black and printed "V1"
A3	Black and printed "W1"
A4	Green/Yellow
A5	Blue and printed "15"
A6	White and printed "14"
A7	Red and printed "13"
B1	Black printed "TH1"
B2	Black printed "TH2"

**5.0 Physical & Electrical Characteristics**

Temperature Rating: 90°C  
Voltage Rating: 600V

Design Intended to Meet:

10M cycles @ 10x O.D.  
Torsional – 100K cycles ±180° @ 1 Meter

**6.0 Standards**

UL: TYPE TC-ER  
CSA: AWM I/II A/B FT4  
RoHS COMPLIANT

VersaBOSS™ FC  
Cable Specifications



Amphenol Sine Systems







This page intentionally left blank.

## MC - 9 Position Specifications

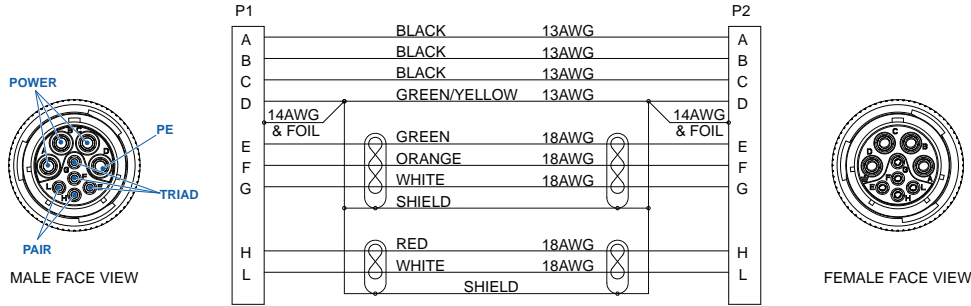
Housing Body	Zinc Die-cast, Nickel-plated	Insulation Resistance (Min.)	5000M OHMS
Coupling Nut	Aluminum Alloy, Nickel-plated	Dielectric Test Voltage	2200V
Wave Springs	Stainless Steel	Temperature Range	-40°C to 105°C
Insulation Insert	Thermoplastic, UL 94/V-0	Protection	IP67 (Mated Condition)
Contacts	Gold Flash-plating over Copper Alloy	Mating Cycles	>500
Seal and O-Rings	NBR (Nitrile Butadiene Rubber)	Vibration Resistance	Per MIL-STD-202 Method 204
Overmold Material	Polyurethane	Thermal Shock	Per MIL-STD-202 Method 207
Cable Jacket Material	High Flex: TPE, Yellow; Static: PVC, Black	48 Hour Salt Spray	Per MIL-STD-202 Method 101



## MC - 9 Position Cable Assemblies

Mxxx = length in meters

9 Position: 600V Power; 30V Signal (Up to 20A Power, 5A Signal): Keying Position - N	
Wiring Diagram	
Number of Contacts	(4) 13AWG, (5) 18AWG
Cable Type	High-Flex, TPE, Yellow Jacket
	Static, PVC, Black Jacket
Male Straight, Single-rated, Black Overmold <i>(See FIG 1, Pg 79)</i>	 <p>P30552-Mxxx</p>  <p>P30664-Mxxx</p>
Female Straight, Single-rated, Black Overmold <i>(See FIG 2, Pg 79)</i>	 <p>P30553-Mxxx</p>  <p>P30665-Mxxx</p>
Male/Female Straight, Single-rated, Black Overmold <i>(See FIG 3, Pg 79)</i>	 <p>P30165-Mxxx</p>  <p>P30648-Mxxx</p>

## MC - 9 Position Receptacles

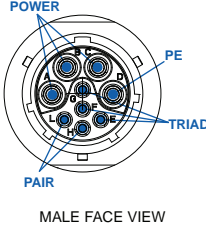
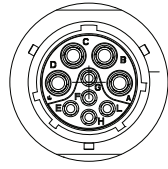
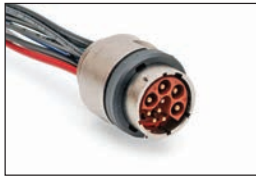
Exxx = length in feet, Hxxx = length in inches

9 Position; 600V Power; 30V Signal (Up to 20A Power, 5A Signal); Keying Position - N																																																							
Male Face View	 <table border="0" style="display: inline-table; vertical-align: top;"> <tr><td>A</td><td>BLACK 14AWG</td><td>A</td></tr> <tr><td>B</td><td>BLACK 14AWG</td><td>B</td></tr> <tr><td>C</td><td>BLACK 14AWG</td><td>C</td></tr> <tr><td>D</td><td>GREEN/YELLOW 14AWG</td><td>D</td></tr> <tr><td>E</td><td>GREEN 18AWG</td><td>E</td></tr> <tr><td>F</td><td>ORANGE 18AWG</td><td>F</td></tr> <tr><td>G</td><td>WHITE 18AWG</td><td>G</td></tr> <tr><td>H</td><td>RED 18AWG</td><td>H</td></tr> <tr><td>L</td><td>WHITE 18AWG</td><td>L</td></tr> </table> <table border="0" style="display: inline-table; vertical-align: top; margin-left: 20px;"> <tr><td>A</td><td>BLACK 14AWG</td><td>A</td></tr> <tr><td>B</td><td>BLACK 14AWG</td><td>B</td></tr> <tr><td>C</td><td>BLACK 14AWG</td><td>C</td></tr> <tr><td>D</td><td>GREEN/YELLOW 14AWG</td><td>D</td></tr> <tr><td>E</td><td>GREEN 18AWG</td><td>E</td></tr> <tr><td>F</td><td>ORANGE 18AWG</td><td>F</td></tr> <tr><td>G</td><td>WHITE 18AWG</td><td>G</td></tr> <tr><td>H</td><td>RED 18AWG</td><td>H</td></tr> <tr><td>L</td><td>WHITE 18AWG</td><td>L</td></tr> </table> 	A	BLACK 14AWG	A	B	BLACK 14AWG	B	C	BLACK 14AWG	C	D	GREEN/YELLOW 14AWG	D	E	GREEN 18AWG	E	F	ORANGE 18AWG	F	G	WHITE 18AWG	G	H	RED 18AWG	H	L	WHITE 18AWG	L	A	BLACK 14AWG	A	B	BLACK 14AWG	B	C	BLACK 14AWG	C	D	GREEN/YELLOW 14AWG	D	E	GREEN 18AWG	E	F	ORANGE 18AWG	F	G	WHITE 18AWG	G	H	RED 18AWG	H	L	WHITE 18AWG	L
A	BLACK 14AWG	A																																																					
B	BLACK 14AWG	B																																																					
C	BLACK 14AWG	C																																																					
D	GREEN/YELLOW 14AWG	D																																																					
E	GREEN 18AWG	E																																																					
F	ORANGE 18AWG	F																																																					
G	WHITE 18AWG	G																																																					
H	RED 18AWG	H																																																					
L	WHITE 18AWG	L																																																					
A	BLACK 14AWG	A																																																					
B	BLACK 14AWG	B																																																					
C	BLACK 14AWG	C																																																					
D	GREEN/YELLOW 14AWG	D																																																					
E	GREEN 18AWG	E																																																					
F	ORANGE 18AWG	F																																																					
G	WHITE 18AWG	G																																																					
H	RED 18AWG	H																																																					
L	WHITE 18AWG	L																																																					
Number of Contacts	(4) 13AWG, (5) 18AWG																																																						
Type	Male																																																						
Black Color Band (See FIG 4 and 5, Pg 80)	 <p>P30167- (Select either Exxx or Hxxx)</p>																																																						
	Female																																																						
	 <p>P30166- (Select either Exxx or Hxxx)</p>																																																						

## Dimensional Drawings

FIG 1: Male, Plug, Straight, 9 Position

FIG 2: Female, Plug, Straight, 9 Position

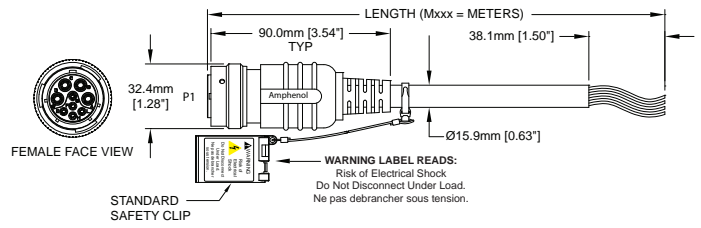
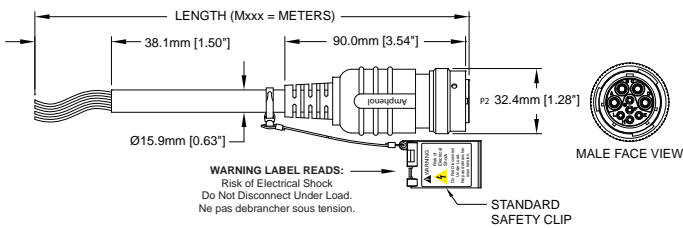
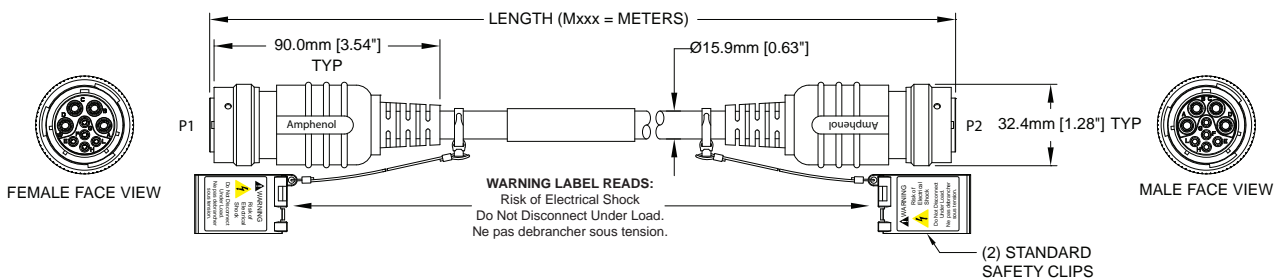

FIG 3: Male Plug to Female Plug, Straight, 9 Position



All Dimensions in: mm [inch]



Dimensional Drawings, cont.

FIG 4: Male, Receptacle, Straight, 9 Position

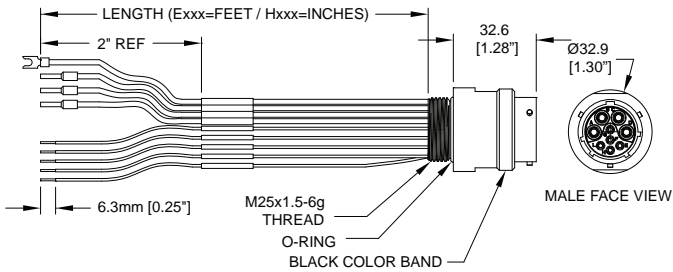
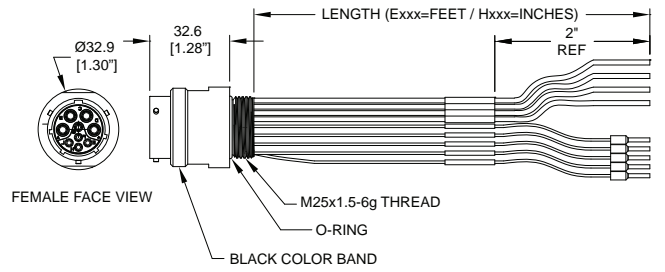
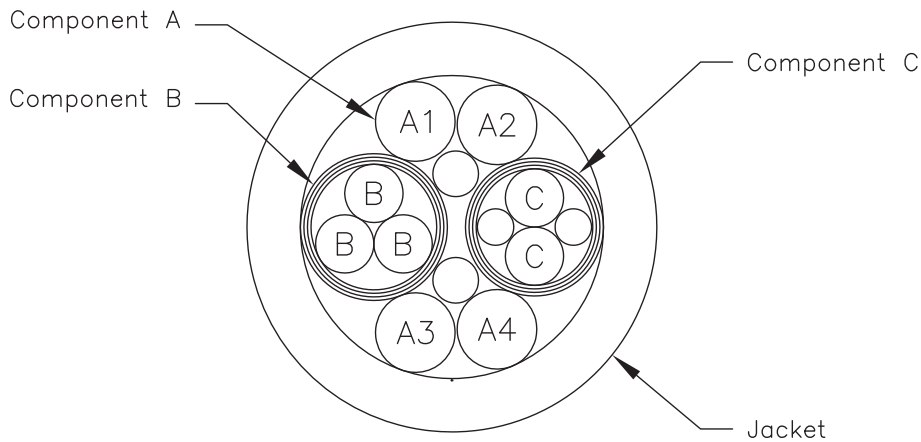

FIG 5: Female, Receptacle, Straight, 9 Position



All Dimensions in: mm [inch]



**1.0 Component A – 13 AWG**

13 AWG: Bare Copper  
Insulation: PVC/Nylon

**2.0 Component B – Shielded Triad – 18 AWG**

18 AWG: Bare Copper  
Insulation: PVC/Nylon  
Triad: (3) Conductors Cabled Together  
Binder: PTFE Tape  
Shield: Tinned Copper Spiral Shield, 95% Coverage  
Separator: PTFE Tape

**3.0 Component C – Shielded Pair – 18 AWG**

18 AWG: Bare Copper  
Insulation: PVC/Nylon  
Fillers: Solid PVC  
Pair: (2) Conductors Cabled Together with Fillers  
Binder: PTFE Tape  
Shield: Tinned Copper Spiral Shield, 95% Coverage  
Separator: PTFE Tape

**4.0 Construction**

Core: (4) Component A, (1) Component B, (1) Component C and Solid Fillers as required for roundness.

Jacket: .070" TPE, Color: Yellow  
Diameter: .631" Nominal  
Print Legend: AMPHENOL SINE SYSTEMS KA-56576 (UL File #)  
4/C 13 AWG + 5/C 18 AWG (UL) TYPE TC-ER  
90C DRY 75C WET 600V SUN RES DIR BUR ---  
(CSA FILE #) CSA AWM I/II A/B 90C 600V FT4

COLOR CODE

Component	COLOR
A1	Black and printed "L1"
A2	Black and printed "L2"
A3	Black and printed "L3"
A4	Green/Yellow
B	White, Orange and Green
C	White and Red

**6.0 Physical & Electrical Characteristics**

Temperature Rating: 90°C  
Voltage Rating: 600V  
  
Design Intended to Meet:  
10M cycles @ 10x O.D.  
Torsional – 100K cycles ±180° @ 1 Meter

**7.0 Standards**

UL: TYPE TC-ER  
CSA: AWM I/II A/B FT4  
RoHS COMPLIANT

VersaBOSS™ MC  
Cable Specifications



Amphenol Sine Systems







This page intentionally left blank.

## Powerflex - 9 Position Specifications

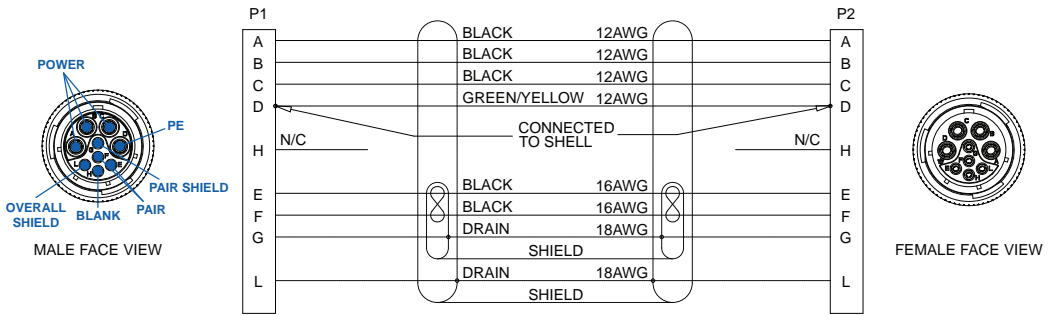
Housing Body	Zinc Die-cast, Nickel-plated	Insulation Resistance (Min.)	5000M OHMS
Coupling Nut	Aluminum Alloy, Nickel-plated	Dielectric Test Voltage	2200V
Wave Springs	Stainless Steel	Temperature Range	-40°C to 105°C
Insulation Insert	Thermoplastic, UL 94/V-0	Protection	IP67 (Mated Condition)
Contacts	Gold Flash-plating over Copper Alloy	Mating Cycles	>500
Seal and O-Rings	NBR (Nitrile Butadiene Rubber)	Vibration Resistance	Per MIL-STD-202 Method 204
Overmold Material	Polyurethane	Thermal Shock	Per MIL-STD-202 Method 207
Cable Jacket Material	High Flex: TPE, Yellow; Static: PVC, Black	48 Hour Salt Spray	Per MIL-STD-202 Method 101





## Powerflex - 9 Position Cable Assemblies

Mxxx = length in meters

9 Position; 600V Power; 30V Signal (Up to 20A Power, 5A Signal); Keying Position - X	
Wiring Diagram	 <p>MALE FACE VIEW</p> <p>FEMALE FACE VIEW</p>
Number of Contacts	(4) 12AWG, (2 Pair) 16AWG VFD Cables are 9 pin insert configurations that utilize only 8 pins.
Cable Type	High-Flex, TPE, Yellow Jacket   Static, PVC, Black Jacket
Male Straight, Single-rated, Yellow Overmold <i>(See FIG 1, Pg 83)</i>	 <p>P30706-Mxxx</p>  <p>P30708-Mxxx</p>
Female Straight, Single-rated, Yellow Overmold <i>(See FIG 2, Pg 83)</i>	 <p>P30707-Mxxx</p>  <p>P30709-Mxxx</p>
Male/Female Straight, Single-rated, Black Overmold <i>(See FIG 3, Pg 83)</i>	 <p>P30412-Mxxx</p>  <p>P30618-Mxxx</p>

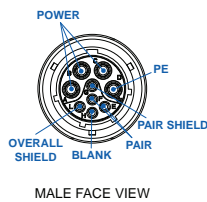
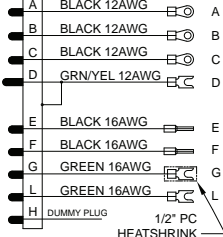
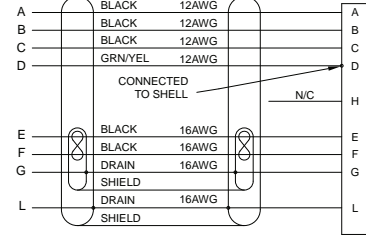
## Powerflex - 9 Position Receptacles

Exxx = length in feet, Hxxx = length in inches

9 Position; 600V Power; 30V Signal (Up to 20A Power, 5A Signal); Keying Position - X	
Male Face View	   
Number of Contacts	(4) 12AWG, (2) 16AWG, (2) 18AWG VFD Receptacles are 9 pin insert configurations that utilize only 8 pins.
Type	Male <span style="margin-left: 200px;">Female</span>
Yellow Color Band <i>(See FIG 4 and 5, Pg 84)</i>	 <span style="margin-left: 100px;"></span>
	P30545- (Select either Exxx or Hxxx) <span style="margin-left: 200px;">P30544- (Select either Exxx or Hxxx)</span>

## Dimensional Drawings

FIG 1: Male, Plug, Straight, 9 Position

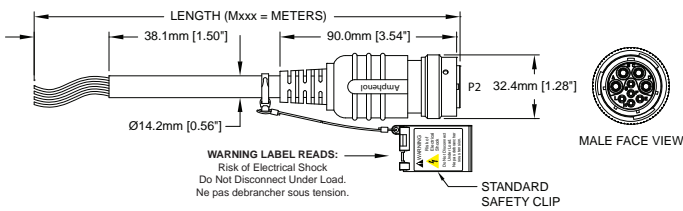

FIG 2: Female, Plug, Straight, 9 Position

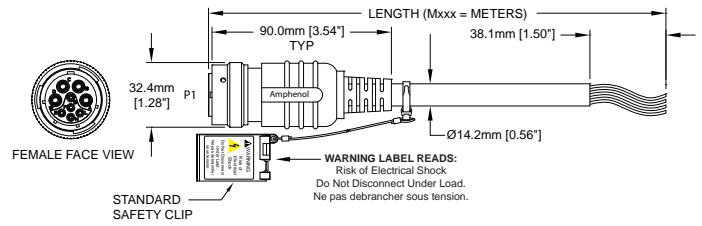
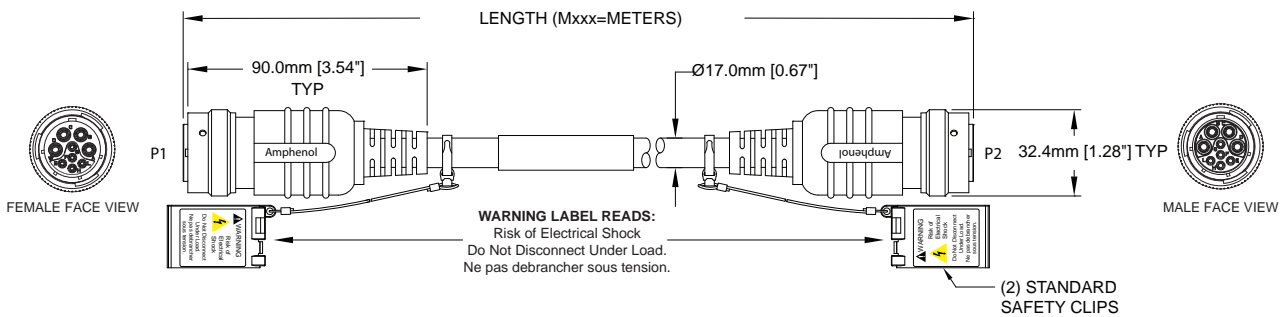

FIG 3: Male Plug to Female Plug, Straight, 9 Position



All Dimensions in: mm [inch]

Dimensional Drawings, cont.

FIG 4: Male, Receptacle, Straight, 9 Position

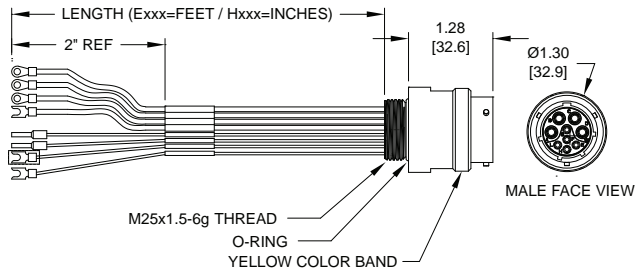
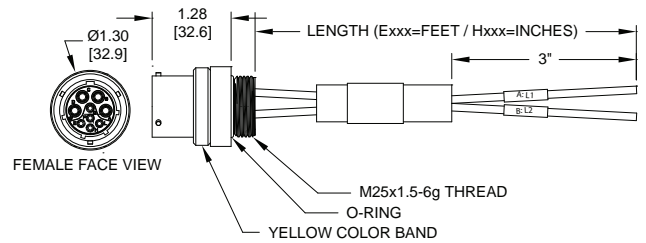
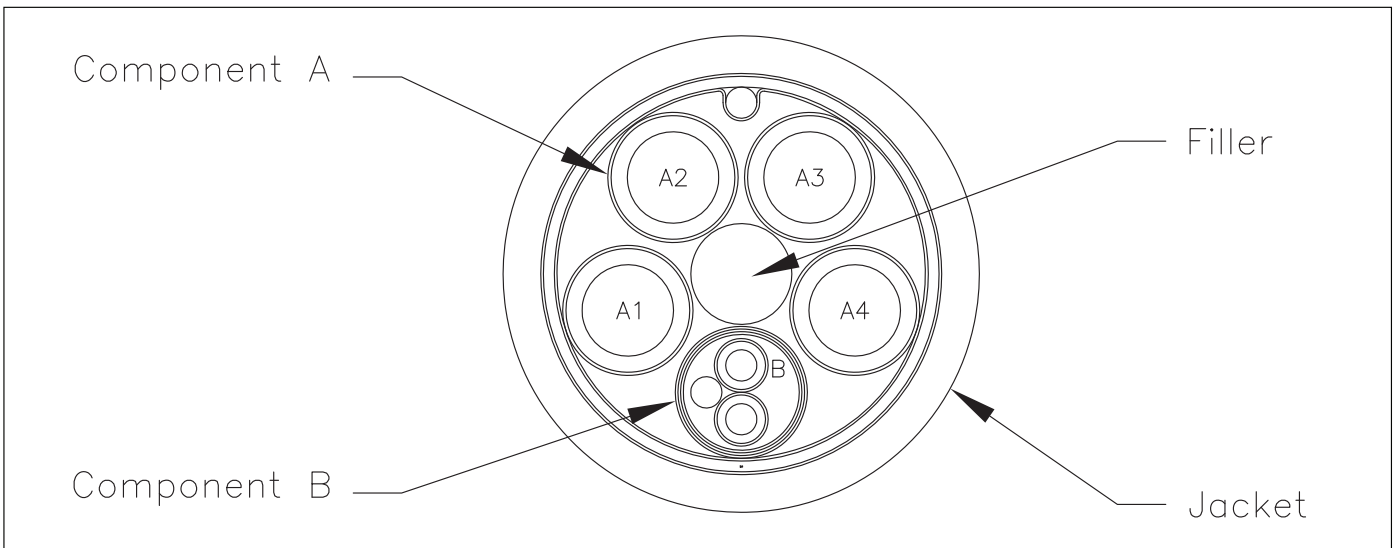

FIG 5: Female, Receptacle, Straight, 9 Position



All Dimensions in: mm [inch]



1.0 Component A – 12 AWG

12 AWG: Bare Copper  
Insulation: PVC/Nylon

2.0 Component B – Shielded Pair – 16 AWG

16 AWG: Bare Copper  
Insulation: PVC/nylon  
Pair: (2) Conductors Cabled Together  
Binder: Tape  
Drain Wire: 18 AWG Tinned Copper  
Shield: Alum–Mylar Tape, Alum Facing In  
Separator: Tape

3.0 Construction

Core: (4) Component A, (1) Component B and Fillers as required for roundness.  
Binder: Tape  
Drain Wire: 18 AWG Tinned Copper  
Shield: Foil, Alum–Mylar–Alum  
Shield: Tinned Copper Braided Shield, 95% Coverage  
Binder: Tape  
Jacket: .070" TPE, Color: Yellow  
Diameter: 0.680" Nominal

4.0 Print Legend

AMPHENOL SINE SYSTEMS KA-56628 (UL File #)  
4/C 12 AWG + 1/PR 16 AWG (UL) TYPE TC-ER  
90C DRY 75C WET 600V SUN RES DIR BUR ---  
(CSA FILE #) CSA AWM 1/II A/B 90C 600V FT4

COLOR CODE

Component	COLOR
A1	Black and printed "L1"
A2	Black and printed "L2"
A3	Black and printed "L3"
A4	Green/Yellow
B	Black #5 and Black #6

5.0 Physical & Electrical Characteristics

Temperature Rating: 90°C  
Voltage Rating: 600V

Design Intended to Meet:  
5M cycles @ 10x O.D.

6.0 Standards

UL: TYPE TC-ER  
CSA: AWM 1/II A/B FT4  
RoHS COMPLIANT

VersaBOSS™ Powerflex  
Cable Specifications



Amphenol Sine Systems

This page intentionally left blank.

# ControlPower™

The **ControlPower™** line is a 6 pin/5 use option to support the ongoing requests from our customers seeking alternatives from other cable assembly providers. This system utilizes UL Dual-rated TC-ER STOOW and CSA STOOW cable.



## 6 Position/5 Used Specifications

Temperature Range	-20°C to +105°C	Cable Jacket Material	PVC, Black
Housing Body/Face	Oil-resistant PVC	Cable Rating	UL listed, Dual-Rated TC-ER/STOOW
Coupling Nut	Machined Aluminum, Anodized	Cable Voltage	600V, 90°C dry and 75°C wet (TC-ER), 105°C (STOOW)
Receptacle Housing	Machined Aluminum, Anodized	Cable Certification	CSA certified type STOOW
Contacts	Copper Alloy	Cable Insulation	PVC insulated #16AWG stranded copper (65x34)
Contact Plating	5µ inches (min) Gold, over 25µ inches (min) Nickel	Cable Diameter	.49" (12.5mm)

## 6 Position/5 Used Cable Assemblies and Receptacles

Mxxx = length in meters

6 Position/5 Used; 600VAC; 600VDC; 10A; 16AWG	
Male Face View	<p style="text-align: center;">Plug                      Receptacle</p>
Color Code	1 - Red, 2 - Black, 3 - Green, 4 - Not Used, 5 - Blue, 6 - White

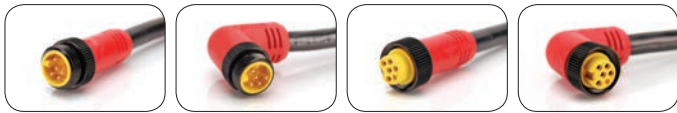

Plug - Description	See FIG/Pg	Part Number
Male Straight	FIG 1, Pg 88	MN657AC07-Mxxx
Male 90°	FIG 3, Pg 88	MN657BC07-Mxxx
Female Straight	FIG 2, Pg 88	MN654AC07-Mxxx
Female 90°	FIG 4, Pg 88	MN654BC07-Mxxx
Male Straight/Female Straight	FIG 1 and 2, Pg 88	MN657A4AC07-Mxxx
Male 90°/Female Straight	FIG 2 and 3, Pg 88	MN657B4AC07-Mxxx
Male Straight/Female 90°	FIG 1 and 4, Pg 88	MN657A4BC07-Mxxx
Male 90°/Female 90°	FIG 3 and 4, Pg 88	MN657B4BC07-Mxxx

Receptacle - Description	See FIG/Pg	Part Number
Male Straight, External Threading	FIG 5, Pg 89	MN651PW02-Mxxx
Female Straight, Internal Threading	FIG 6, Pg 89	MN654PW02-Mxxx





### 6 Position/5 Used - Tees

Tee - Description	See FIG/Pg	Part Number
Tee, E-Stop In, Black	FIG 7, Pg 89	P29313
Tee, E-Stop Out, Red	FIG 8, Pg 89	P29328
Tee, 4 Pos., Mini, Black	FIG 9, Pg 89	P30965



### 6 Position/5 Used - Shorting Plugs

Shorting Plug - Description	See FIG/Pg	Part Number
Plug, E-Stop Out, Black	FIG 10, Pg 89	P29326
Plug, E-Stop In, Red	FIG 11, Pg 89	P29325



### Dustcaps

Dustcap - Description	See FIG/Pg	Part Number
Male, Internal Threads	FIG 12, Pg 89	P29044
Female, External Threads	FIG 13, Pg 89	P29045



### Dimensional Drawings

Mxxx = length in meters

**FIG 1: Male, Plug, Straight, 6P/5U**

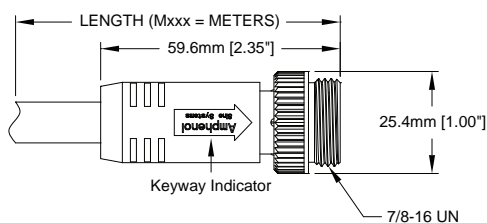

**FIG 2: Female, Plug, Straight, 6P/5U**

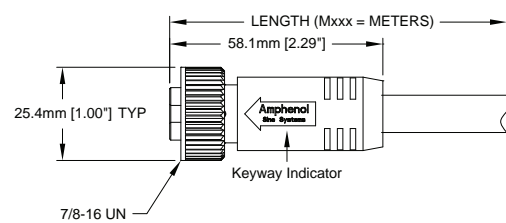

**FIG 3: Male, Plug, 90°, 6P/5U**

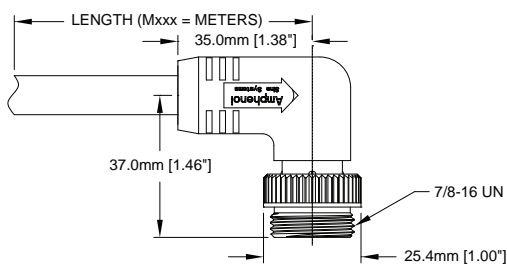

**FIG 4: Female, Plug, 90°, 6P/5U**

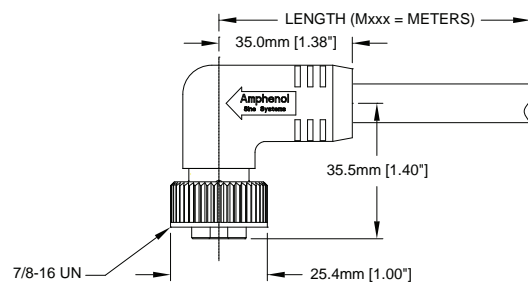

All Dimensions in: mm [inch]

Dimensional Drawings, cont.

Mxxx = length in meters

FIG 5: Male, Receptacle, Straight, 6P/5U

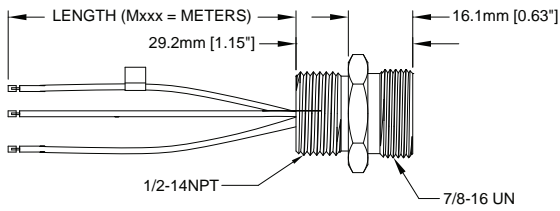

FIG 6: Female, Receptacle, Straight, 6P/5U

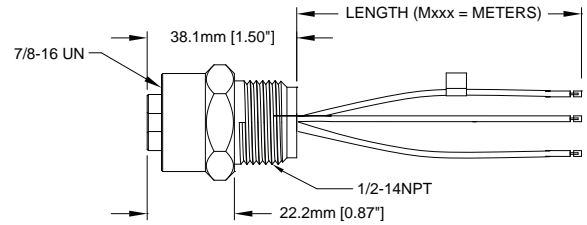

FIG 7: Tee, E-Stop In, Black, 6P/5U

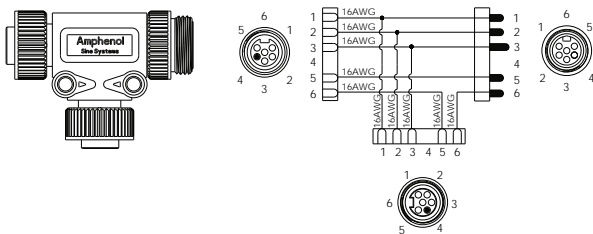

FIG 8: Tee, E-Stop Out, Red, 6P/5U

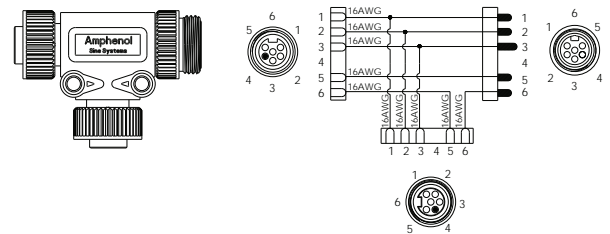

FIG 9: Tee, Mini, Black, 4 Pos.

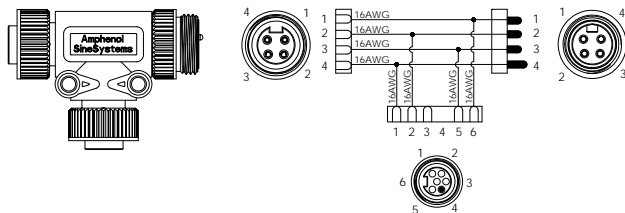

FIG 10: Shorting Plug, E-Stop In, Black, 6P/5U

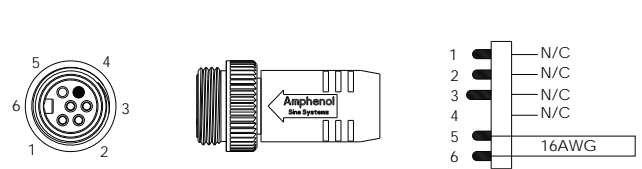

FIG 11: Shorting Plug, E-Stop Out, Red, 6P/5U

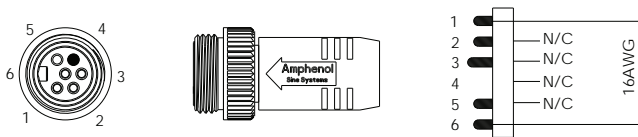

FIG 12: Male, Dustcap, Internal Threads

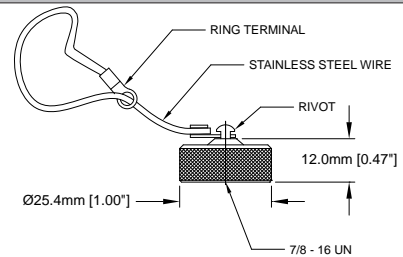
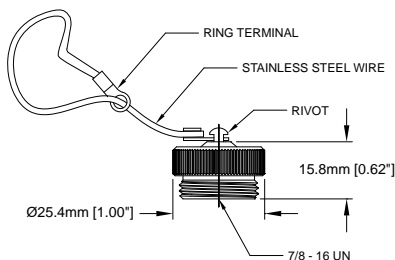

FIG 13: Female, Dustcap, External Threads



All Dimensions in: mm [inch]

# miniBOSS™ M22

Power Distribution System

The miniBOSS™ M22 system is offered in 2, 3, 4, 5 and 6 position configurations. This system allows for cost-effective power and signal distribution, utilizing UL ST00W/CSA Type ST cable, as well as High Flex TPE jacketed UL Listed TC-ER cable.



# miniBOSS™ M22 (7/8")



## 2, 3, 4, 5 and 6 Position Specifications

Temperature Range	-20°C to +105°C	Cable Jacket	PVC, Yellow
Housing Body/Face	Oil-resistant PVC	Cable Rating	UL Listed Type STOOW
Coupling Nut	Machined Aluminum, Anodized	Cable Voltage	600V, 105°C
Receptacle Housing	Machined Aluminum, Anodized	Cable Certification	CSA certified type ST
Contacts	Copper Alloy	Cable Insulation	PVC insulated #16AWG stranded copper (65x34)
Contact Plating	5µ inches (min) Gold, over 25µ inches (min) Nickel	Cable Diameter	2/C - .37" (9.4mm); 3/C - .41" (10.4mm) 4/C - .42" (10.7mm); 5/C - .50" (12.7mm) 6/C - .54" (13.7mm)

## 2, 3, 4, 5 and 6 Position Cable Assemblies and Receptacles

Mxxx = length in meters

	2P	3P	4P	5P	6P
Male Face View					
Color Code	1-White, 2-Black	1-Green, 2-Black, 3-White	1-Black, 2-White, 3-Red, 4-Green	1-White, 2-Red, 3-Green, 4-Orange, 5-Black	1-White, 2-Red, 3-Green, 4-Orange, 5-Black, 6-Blue
Current	13A		10A		8A
Voltage	600V				
Conductor	16AWG				
Receptacle Wire Style	MTW and AWM 1015				

Plug - Description	See FIG/Pg	2P	3P	4P	5P	6P
M-Str., Int. Thread	FIG 1, Pg 92	MN23AC01Mxxx	MN33AC01Mxxx	MN43AC01Mxxx	MN53AC01Mxxx	MN63AC01Mxxx
M-90°, Ext. Thread	FIG 5, Pg 92	MN23BC01Mxxx	MN33BC01Mxxx	MN43BC01Mxxx	MN53BC01Mxxx	MN63BC01Mxxx
F-Str, Int. Thread	FIG 2, Pg 92	MN24AC01Mxxx	MN34AC01Mxxx	MN44AC01Mxxx	MN54AC01Mxxx	MN64AC01Mxxx
F-90°, Int. Thread	FIG 4, Pg 92	MN24BC01Mxxx	MN34BC01Mxxx	MN44BC01Mxxx	MN54BC01Mxxx	MN64BC01Mxxx
M-Str, Ext. Thread/ F-Str, Internal Thread	FIG 3, Pg 92/ FIG 2, Pg 92	MN27A4AC01Mxxx	MN37A4AC01Mxxx	MN47A4AC01Mxxx	MN57A4AC01Mxxx	MN67A4AC01Mxxx
M-90°, Ext. Thread/ F-Str, Internal Thread	FIG 5, Pg 92/ FIG 2, Pg 92	MN27B4AC01Mxxx	MN37B4AC01Mxxx	MN47B4AC01Mxxx	MN57B4AC01Mxxx	MN67B4AC01Mxxx
M-Str, Ext. Thread/ F-90°, Int. Thread	FIG 3, Pg 92/ FIG 4, Pg 92	MN27A4BC01Mxxx	MN37A4BC01Mxxx	MN47A4BC01Mxxx	MN57A4BC01Mxxx	MN67A4BC01Mxxx
M-90°, Ext. Thread/ F-90°, Int. Thread	FIG 5, Pg 92/ FIG 4, Pg 92	MN27B4BC01Mxxx	MN37B4BC01Mxxx	MN47B4BC01Mxxx	MN57B4BC01Mxxx	MN67B4BC01Mxxx

Receptacle - Description	See FIG/Pg	2P	3P	4P	5P	6P
M, Ext. Thread	FIG 5, Pg 93	MN21PW02Mxxx	MN31PW02Mxxx	MN41PW02Mxxx	MN51PW02Mxxx	MN61PW02Mxxx
F, Ext. Thread	FIG 6, Pg 93	MN22PW02Mxxx	MN32PW02Mxxx	MN42PW02Mxxx	MN52PW02Mxxx	MN62PW02Mxxx
F, Int. Thread	FIG 7, Pg 93	MN24PW02Mxxx	MN34PW02Mxxx	MN44PW02Mxxx	MN54PW02Mxxx	MN64PW02Mxxx



### 3, 4 and 5 Position - Tees

Description	See FIG/Pg	Part Number
3 Pos., 600V, 13A	FIG 8, Pg 93	P29309
4 Pos., 600V, 10A	FIG 9, Pg 93	P29310
5 Pos., 600V, 8A	FIG 10, Pg 93	P29311



### Dustcaps and Threaded Unions

Description	See FIG/Pg	Part Number
Male, Internal Threads	FIG 11, Pg 93	P29044
Female External Threads	FIG 12, Pg 93	P29045
Aluminum Threaded Union (for male and female connectors)	FIG 13, Pg 93	10-54938



### Dimensional Drawings

Mxxx = length in meters

FIG 1: Male, Plug, Straight, Internal Threads

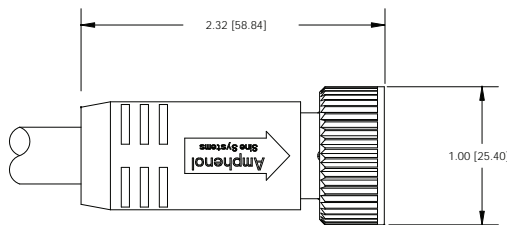

FIG 2: Female, Plug, Straight, Internal Threads

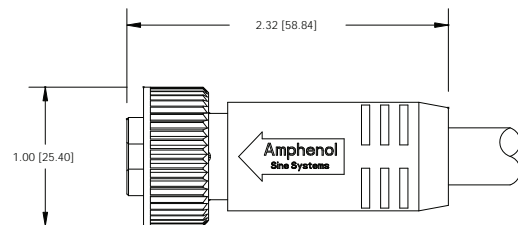

FIG 3: Male, Plug, Straight, External Threads

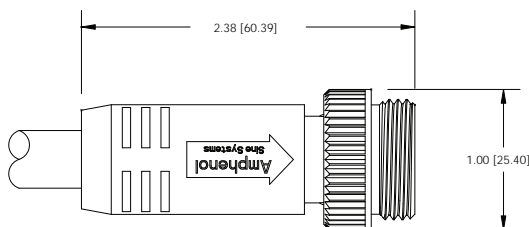
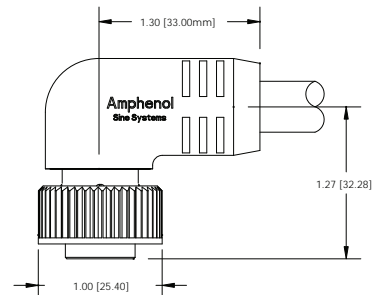

FIG 4: Female, Plug, 90°, Internal Threads



All Dimensions in: mm [inch]

# miniBOSS™ M22 (7/8")

## Dimensional Drawings, cont.

Mxxx = length in meters

**FIG 5: Male, Plug, 90°, External Threads**

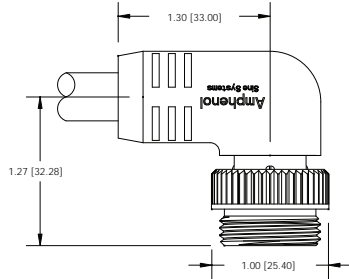

**FIG 6: Male/Female, Receptacle, External Threads**

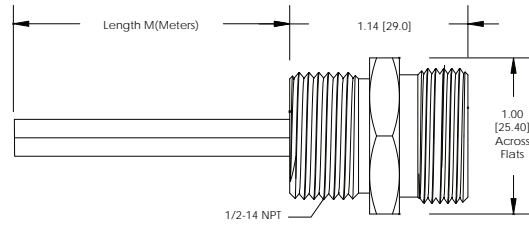

**FIG 7: Female, Receptacle, Internal Threads**

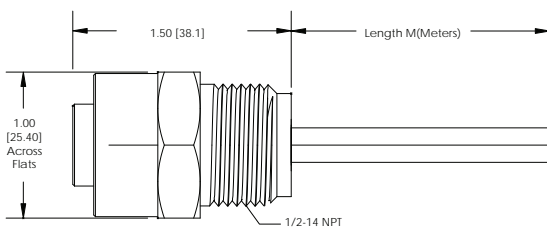

**FIG 8: Tee, 3 Position**

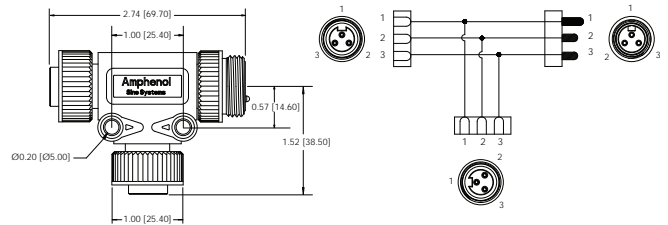

**FIG 9: Tee, 4 Position**

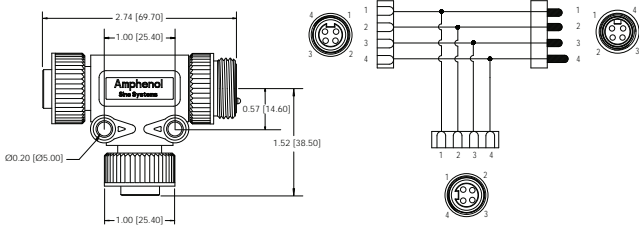

**FIG 10: Tee, 5 Position**

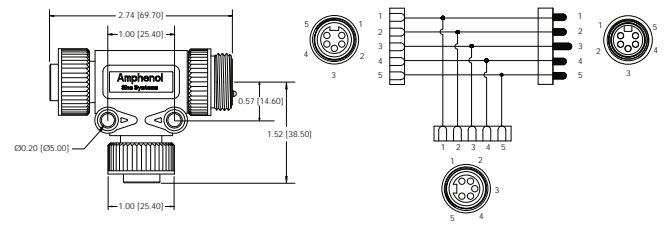

**FIG 11: Male, Dustcap, Internal Threads**

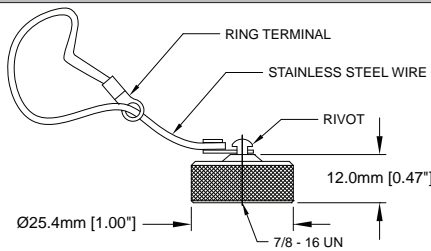

**FIG 12: Female, Dustcap, External Threads**

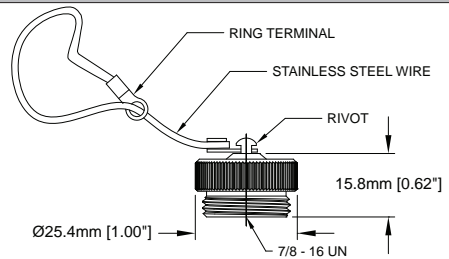

**FIG 13: Threaded Union**

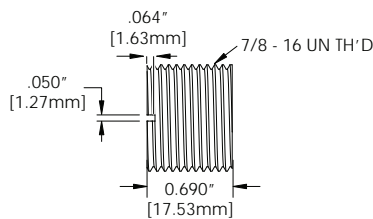

All Dimensions in: mm [inch]

# microBOSS™ M12

## Signal Distribution System

The microBOSS™ M12 system is offered in 3, 4, and 5 pin configurations that deliver signal to a wide variety of devices, utilizing both UL AWM-style 2661 and CSA AWM I/II A/B cable, as well as Flex and High Flex cable options.



# microBOSS™ M12 (1/2")



## 3, 4 and 5 Position Specifications

Temperature Range	-20°C to +105°C	Cable Rating	UL Listed Type STOOW
Housing Body/Face	Oil-resistant PVC/Nylon 6/6	Cable Voltage	600V, 105°C
Coupling Nut/O-Ring	Machined Aluminum, Anodized/Nitrile Rubber	Cable Insulation	PVC insulated #22AWG stranded copper (26x36)
Receptacle Housing	Machined Aluminum, Anodized	Cable Jacket	PVC, Yellow (22AWG); TPE, Yellow (18AWG)
Contacts	Copper Alloy	Contact Plating	5μ inches (min) Gold, over 25μ inches (min) Nickel
Cable Cert. 22AWG	UL AWM Style 2661, CSA AWM I/II A/B, 300V, 105°C; Jacket PVC	Cable Diameter	3/C - .18" (4.6mm); 4/C - .20" (5.1mm); 5/C - .23" (5.8mm)
Cable Cert. 18AWG	UL 18AWG/4C ITC 105°C or PLTC 105°C or CSA AWM I/II AB 90°C 300V FT4; Jacket TPE		

## 3, 4 and 5 Position Cable Assemblies and Receptacles

Mxxx = length in meters

	3P	4P	5P
Male Face View			
Color Code	1-Brown, 2-Not Used, 3-Blue, 4-Black, 5-Not Used	1-Brown, 2-White, 3-Blue, 4-Black, 5-Not Used	1-Brown, 2-White, 3-Blue, 4-Black, 5-Green
Current	4A	4A	4A
Voltage	300V	300V	300V

Plug Description	See FIG/Pg	3P	4P		5P	
Plug Wire Style	-	AWM UL 2661	AWM UL 2661	AWM UL 2661	AWM UL 2661	AWM UL 2661
Conductor	-	22AWG	22AWG	18AWG	22AWG	18AWG
Male Straight	FIG 1, Pg 96	MC37AC05Mxx	MC47AC05Mxx	MC47AC09Mxx	MC57AC05Mxx	MC57AC09Mxx
Male 90°	FIG 3, Pg 96	MC37BC05Mxx	MC47BC05Mxx	MC47BC09Mxx	MC57BC05Mxx	MC57BC09Mxx
Female Straight	FIG 2, Pg 96	MC34AC05Mxx	MC44AC05Mxx	MC44AC09Mxx	MC54AC05Mxx	MC54AC09Mxx
Female 90°	FIG 4, Pg 96	MC34BC05Mxx	MC44BC05Mxx	MC44BC09Mxx	MC54BC05Mxx	MC54BC09Mxx
Male Str/Female Str	FIG 1 and 2, Pg 92	MC37A4AC05Mxxx	MC47A4AC05Mxxx	MC47A4AC09Mxxx	MC57A4AC05Mxxx	MC57A4AC09Mxxx
Male 90°/Female Str	FIG 3 and 2, Pg 92	MC37B4AC05Mxxx	MC47B4AC05Mxxx	MC47B4AC09Mxxx	MC57B4AC05Mxxx	MC57B4AC09Mxxx
Male Str/Female 90°	FIG 1 and 4, Pg 92	MC37A4BC05Mxxx	MC47A4BC05Mxxx	MC47A4BC09Mxxx	MC57A4BC05Mxxx	MC57A4BC09Mxxx
Male 90°/Female 90°	FIG 3 and 4, Pg 92	MC37B4BC05Mxxx	MC47B4BC05Mxxx	MC47B4BC09Mxxx	MC57B4BC05Mxxx	MC57B4BC09Mxxx

Receptacle Description	See FIG/Pg	3P	4P		5P	
Receptacle Wire Style	-	UL1061	UL1061	-	UL1061	-
Conductor	-	22AWG	22AWG	18AWG	22AWG	18AWG
Male, External Threads	FIG 5, Pg 96	MC31PW03Mxx	MC41PW03Mxx	-	MC51PW03Mxx	-
Female, Internal Threads	FIG 6, Pg 96	MC34PW03Mxx	MC44PW03Mxx	-	MC54PW03Mxx	-





## M12 Splitters



Description	See FIG/Pg	(1) 4 Pos. to (2) 3 Pos.	(1) 4 Pos. to (2) 4 Pos.
Male/Female Straight	FIG 7 and 8, Pg 97	P29332	P29333
Male Straight, Female 90	FIG 9, Pg 97	-	P29334

## Dimensional Drawings

FIG 1: Male, Plug, Straight, External Threads

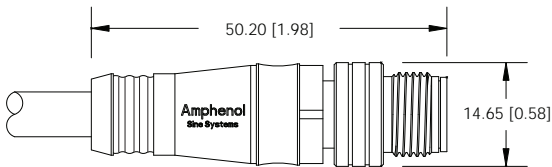

FIG 2: Male, Plug, Straight, Internal Threads

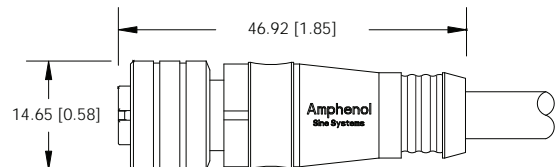

FIG 3: Male, Plug, 90°, External Threads

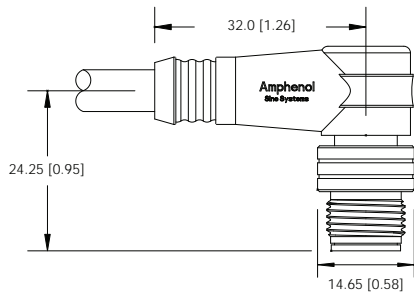

FIG 4: Female, Plug, 90°, Internal Threads

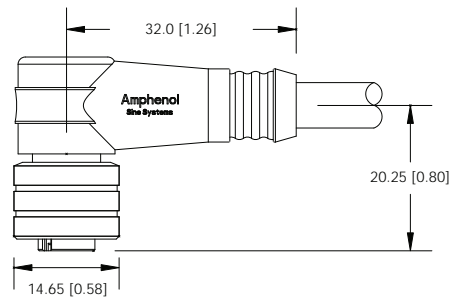

FIG 5: Male, Receptacle, Straight, External Threads

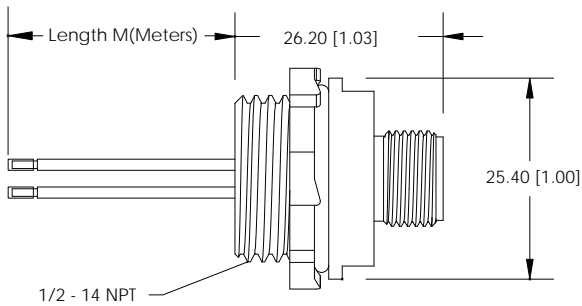
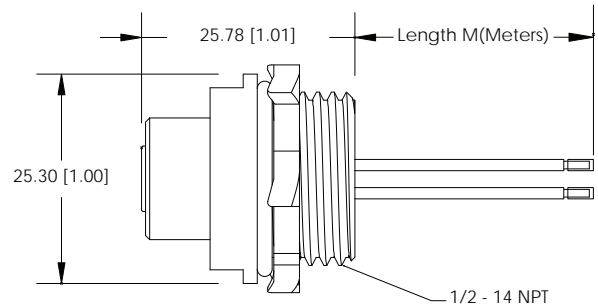

FIG 6: Female, Receptacle, Straight, Internal Threads



All Dimensions in: mm [inch]

# microBOSS™ M12 (1/2")

## Dimensional Drawings, cont.

Mxxx = length in meters

**FIG 7: Male to Female, Splitter, Straight - (1) 4 Pos. to (2) 3 Pos.**

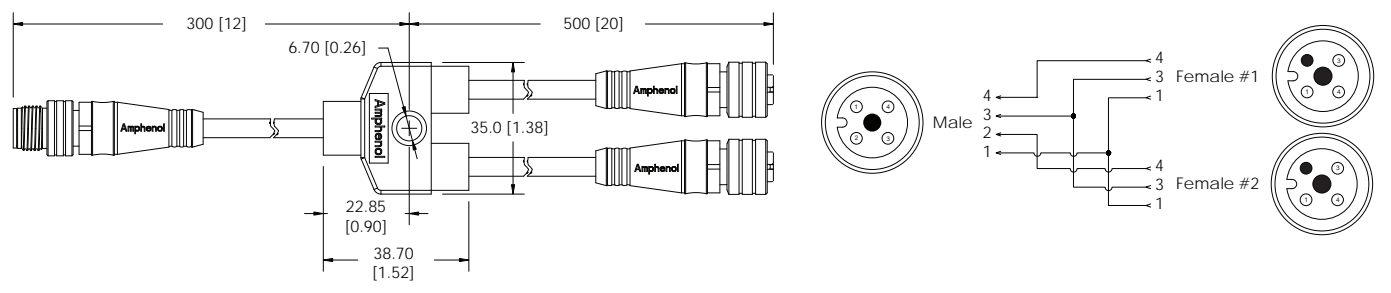

**FIG 8: Male to Female, Splitter, Straight - (1) 4 Pos. to (2) 4 Pos.**

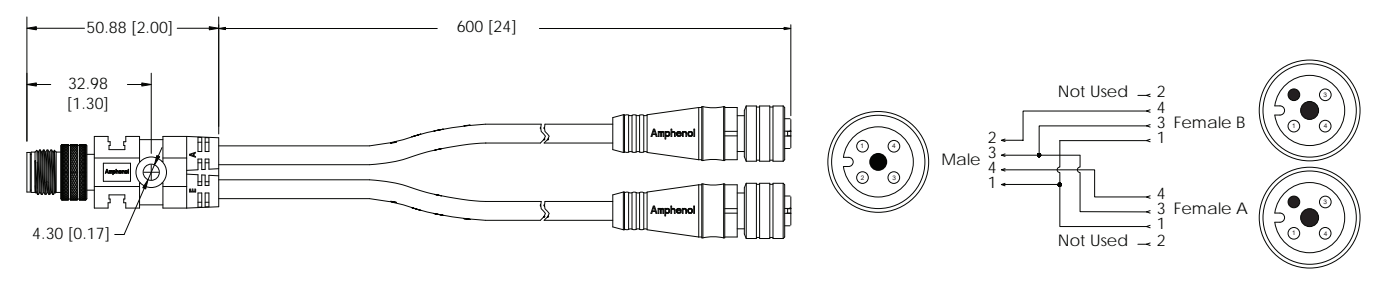

**FIG 9: Male Straight to Female 90°, Splitter - (1) 4 Pos. to (2) 4 Pos.**

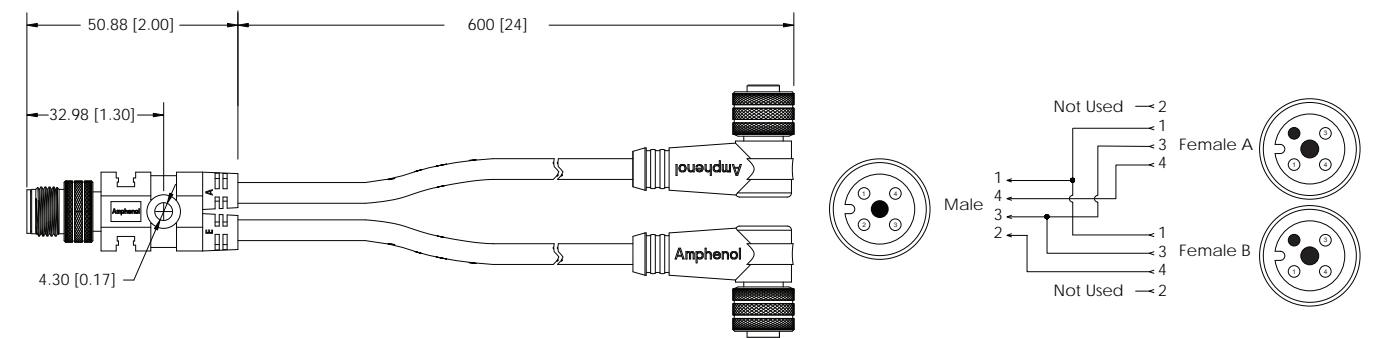

All Dimensions in: mm [inch]

# DeviceNet™

DeviceNet™ cables are available in Mini Thick, Mini Thin and Micro Thin sizes, set to cover the many different demands in the field, utilizing UL Type CL2 or PLTC and CSA AWM I/II A/B FT4 cable, as well as Flex and High Flex cable options.





## 5 Position Specifications

Temperature Range	-20°C to +105°C	Cable Jacket	PVC, Gray
Housing Body/Face	Oil-resistant PVC/PVC (Mini), Nylon 6/6 (Micro)	Contacts	Copper Alloy
Coupling Nut	Aluminum, Anodized	Contact Plating	<b>Mini:</b> 5μ inches (min) Gold, over 25μ inches (min) Nickel; <b>Micro:</b> 5μ inches (min) Gold, over 5μ inches (min) Nickel
Receptacle Housing	Aluminum, Anodized		

Cable: Thick Static - 12.07mm (.457")	Cable: Thin Static - 6.86mm (.270")
Two individually shielded pair inner conductors	Two individually shielded pair inner conductors
Power pair PVC insulated 2 x #15 AWG stranded copper (19 x #28)	Power pair PVC insulated 2 x #22 AWG stranded copper (19 x #34)
Data pair PVC insulated 2 x #18 AWG stranded copper (19 x #30)	Data pair PVC insulated 2 x #24 AWG stranded copper (19 x #36)
Drain wire #18 AWG stranded copper (19 x #30)	Drain wire #22 AWG stranded copper (19 x #34)
UL type CL2 or PLTC; CSA AWM I/II A/B FT4; 300 V, 80° C	UL type CL2 or PLTC; CSA AWM I/II A/B FT4; 300 V, 105° C

## 5 Position Cable Assemblies and Receptacles

Mxxx = length in meters

	5P Mini - Thick	5P Mini - Thin	5P Micro - Thin
Male Face View			
Conductor	15/18AWG	22/24AWG	22/24AWG
Color Code	1-Drain, 2-Red, 3-Black, 4-White, 5-Blue		
Current	See cable		
Voltage	300VAC/VDC		

Plug - Description	See FIG/Pg	5P Mini - Thick	See FIG/Pg	5P Mini - Thin	See FIG/Pg	5P Micro - Thin
Male Straight	FIG 1, Pg 98	MN57AD01Mxx	FIG 1, Pg 98	MN57AD02Mxx	FIG 5, Pg 99	MC57AD02Mxx
Male 90°	FIG 3, Pg 98	MN57BD01Mxx	FIG 3, Pg 98	MN57BD02Mxx	FIG 7, Pg 99	MC57BD02Mxx
Female Straight	FIG 2, Pg 98	MN54AD01Mxx	FIG 2, Pg 98	MN54AD02Mxx	FIG 6, Pg 99	MC54AD02Mxx
Female 90°	FIG 4, Pg 98	MN54BD01Mxx	FIG 4, Pg 98	MN54BD02Mxx	FIG 8, Pg 99	MC54BD02Mxx
Male/Female Straight	FIG 1 and 2, Pg 98	MN57A4AD01Mxx	FIG 1 and 2, Pg 98	MN57A4AD02Mxx	FIG 5 and 6, Pg 99	MC57A4AD02Mxx
Male 90°/ Female Straight	FIG 2 and 3, Pg 98	MN57B4AD01Mxx	FIG 2 and 3, Pg 98	MN57B4AD02Mxx	FIG 6 and 7, Pg 98	MC57B4AD02Mxx
Male Straight/Female 90°	FIG 1 and 4, Pg 98	MN57A4BD01Mxx	FIG 1 and 4, Pg 98	MN57A4BD02Mxx	FIG 5 and 8, Pg 98	MC57A4BD02Mxx
Male/Female 90°	FIG 3 and 4, Pg 98	MN57B4BD01Mxx	FIG 3 and 4, Pg 98	MN57B4BD02Mxx	FIG 7 and 8, Pg 98	MC57B4BD02Mxx

Receptacle - Description	See FIG/Pg	5P Mini - Thick	See FIG/Pg	5P Mini - Thin	See FIG/Pg	5P Micro - Thin
Male, External Threads	FIG 9, Pg 99	MN51PD01Mxx	FIG 10, Pg 99	MN51PD02Mxx	FIG 11, Pg 99	MC51PD02Mxx
Female, Internal Threads	FIG 12, Pg 99	MN54PD01Mxx	FIG 13, Pg 99	MN54PD02Mxx	FIG 14, Pg 99	MC54PD02Mxx

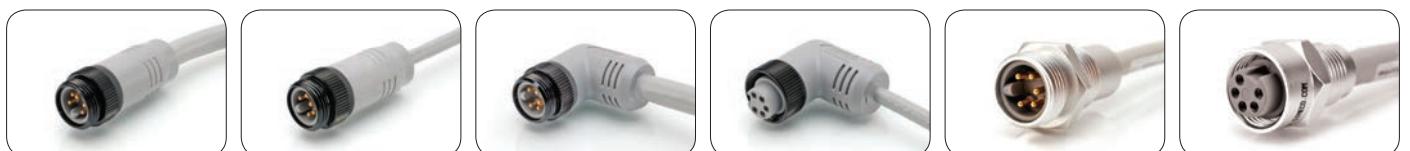

### 5 Position - Terminating Plugs

Description	See FIG/Pg	Part Number
Male, Plug, 121 OHM	FIG 15, Pg 99	P29319
Female, Plug, 121 OHM	FIG 16, Pg 99	P29318



### 5 Position - Tees

Description	See FIG/Pg	Part Number
5 Pos., 300V, 8A	FIG 17, Pg 100	P29312
5 Pos., 300V, 8A, w/ Diode	FIG 18, Pg 100	P29329



### Dustcaps

Description	See FIG/Pg	Part Number
Male, Internal Threads	FIG 19, Pg 100	P29044
Female, External Threads	FIG 20, Pg 100	P29045



### Dimensional Drawings

FIG 1: Male, Mini, Plug, Straight, External Threads

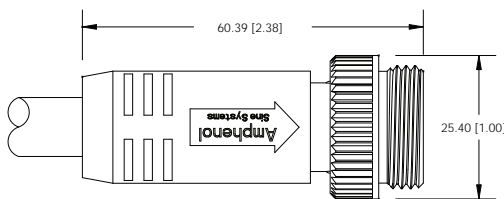

FIG 2: Female, Plug, Mini, Straight, Internal Threads

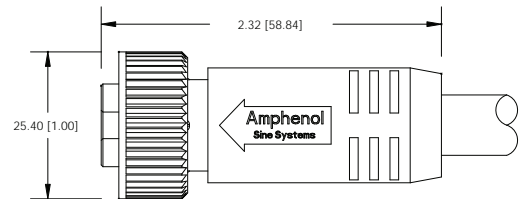

FIG 3: Male, Mini, Plug, 90°, External Threads

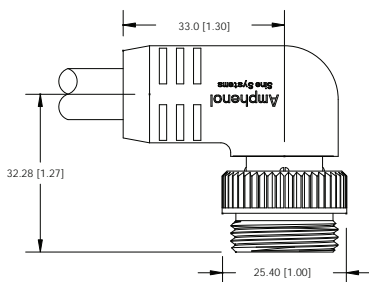
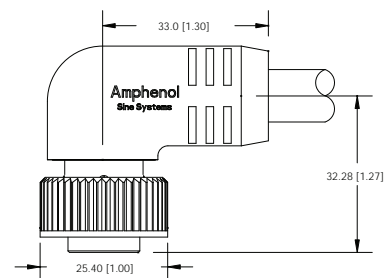

FIG 4: Female, Plug, Mini, 90°, Internal Threads



All Dimensions in: mm [inch]

# DeviceNet™ System



## Dimensional Drawings, cont.

**FIG 5: Male, Plug, Micro, Straight, External Threads**

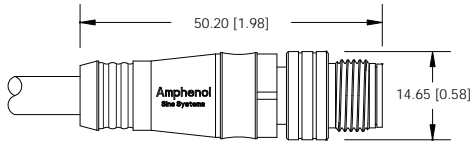

**FIG 6: Female, Micro, Plug, Straight, Internal Threads**

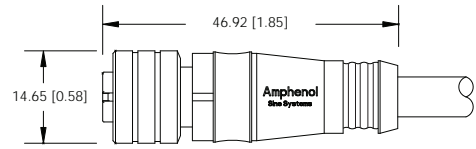

**FIG 7: Male, Micro, Plug, 90°, External Threads**

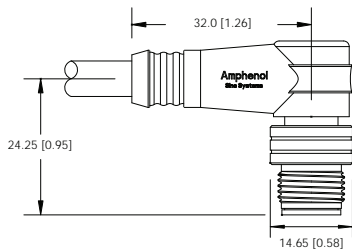

**FIG 8: Female, Micro, Plug, 90°, Internal Threads**

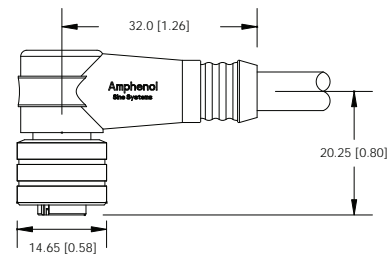

**FIG 9: Male, Mini, Receptacle, Thick, External Threads**

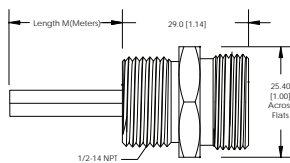

**FIG 10: Male, Mini, Receptacle, Thin, External Threads**

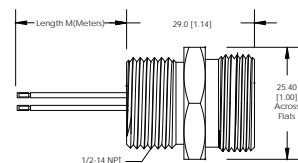

**FIG 11: Male, Micro, Receptacle, Thin, External Threads**

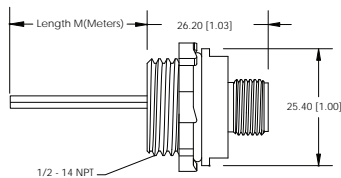

**FIG 12: Female, Mini, Receptacle, Thick, Internal Threads**

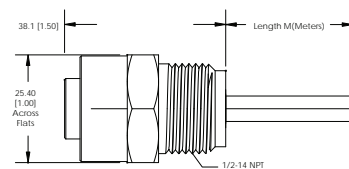

**FIG 13: Female, Mini, Receptacle, Thin, Internal Threads**

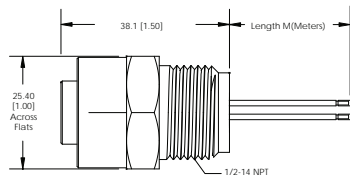

**FIG 14: Female, Micro, Receptacle, Thin, Internal Threads**

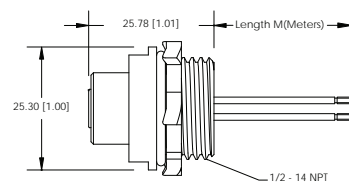

**FIG 15: Male, Terminating Plug, Straight, 5 Position**

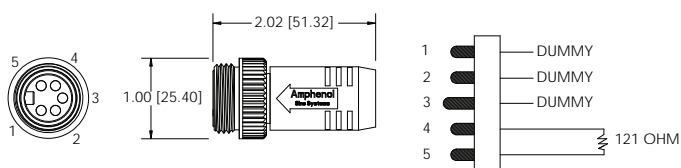

**FIG 16: Female, Terminating Plug, Straight, 5 Position**

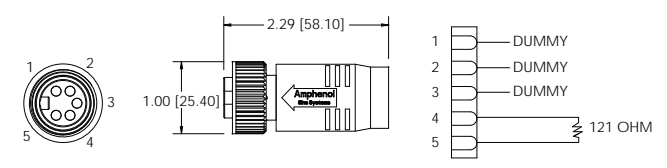

Dimensional Drawings, cont.

FIG 17: Tee, 300V, 8A, 5 Position

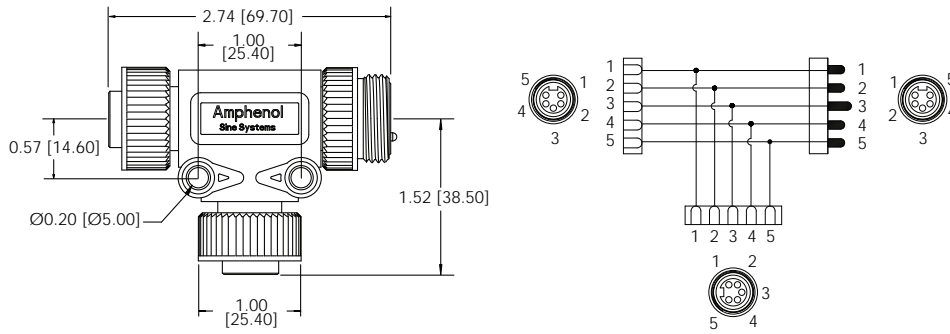

FIG 18: Tee, 300V, 8A, 5 Position, w/ Diode

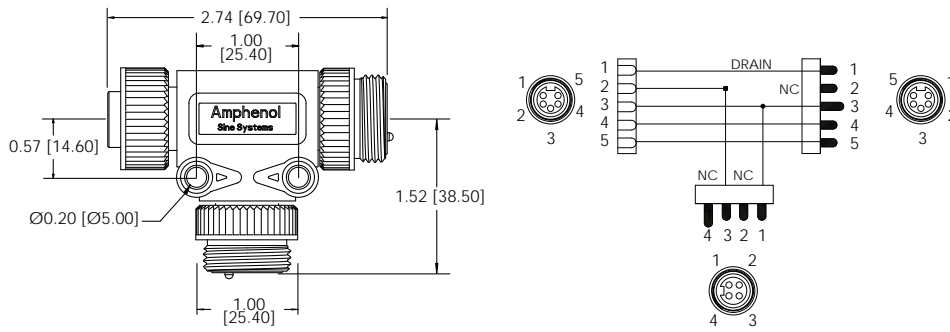

FIG 19: Male, Dustcap, Internal Threads

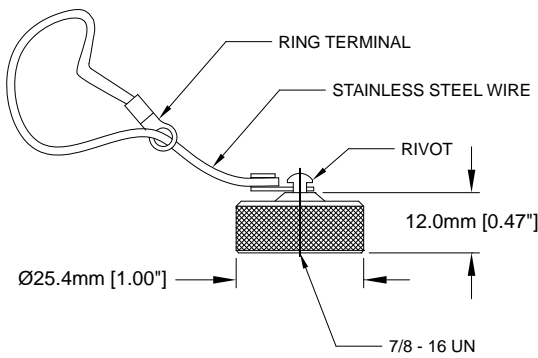
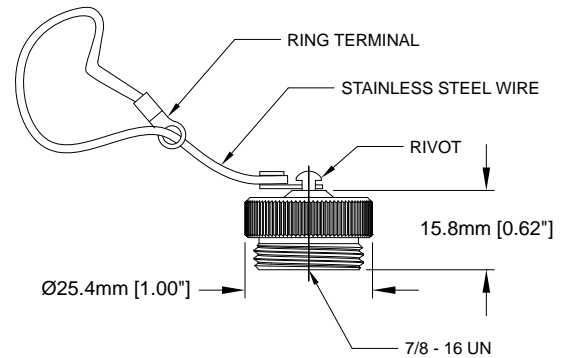

FIG 20: Female, Dustcap, External Threads



All Dimensions in: mm [inch]

This page intentionally left blank.



# Ethernet M12

The **Ethernet M12** product line is a Cat 5e cable available in 24AWG/2 pair, in both M12 and RJ45 combinations, TPE jacketing along with a High Flex option. This jacket material is resistant to abrasion, crush and chemical influences, making it suitable for use in conveyors, sorting, automated storage/retrieval, packaging, overhead transport, palletizing, or your specific application requirements.

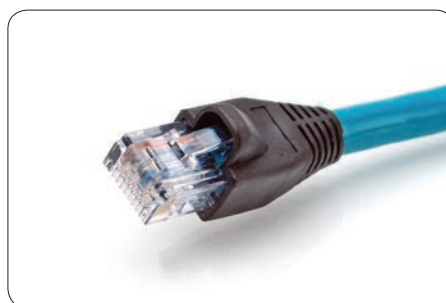

# Ethernet M12



## Specifications

Temperature Range	-25°C to +75°C	Coding	D-Coded (M12 Plugs/Receptacles)
Molded Body/Housing	PUR, Black, Nickel-plated over Copper Alloy	Protection	IP67
Contacts	Brass, Gold over Nickel-plating	Coupling	Brass, Nickel-plated
Inserts	UL Approved Nylon 6/6 (Plugs/Receptacles) Clear Polycarbonate (RJ45)	Approvals	UL 1863, c(UL) CAN/CSA-C22.2

	4 Pos, Male, M12, Plug	4 Pos, Female, M12, Receptacle	8 Pos, RJ45, Plug
Face Views			
Cable Characteristics	CAT 5E, 4 wire/2 pair, unshielded 24AWG (7x32) stranded wires, patch, FT-4, sunlight and oil resistant, RoHS, Jacket TPE		



Plug - Description	Part Number	
RJ45 to RJ45 Male, Blue (See FIG 1, Pg 104)	P29932-Mxxx	
RJ45 to RJ45 Male, Teal (See FIG 2, Pg 104)	P29933-Mxxx	
Ethernet M12, Male to Male, Blue (See FIG 3, Pg 104)	P29934-Mxxx	
Ethernet M12, Male to Male, Teal (See FIG 4, Pg 104)	P29935-Mxxx	
Ethernet M12, Male to Male, Orange (See FIG 5, Pg 104)	P29936-Mxxx	

Receptacle - Description	Part Number	
Ethernet M12, Female to RJ45, Blue (See FIG 6, Pg 105)	P29930-Mxxx	
Ethernet M12, Female to Female, Orange (See FIG 7, Pg 105)	P29931-Mxxx	

Dimensional Drawings

Mxxx = length in meters

FIG 1: P29932-Mxxx, RJ45 to RJ45, Male, Blue

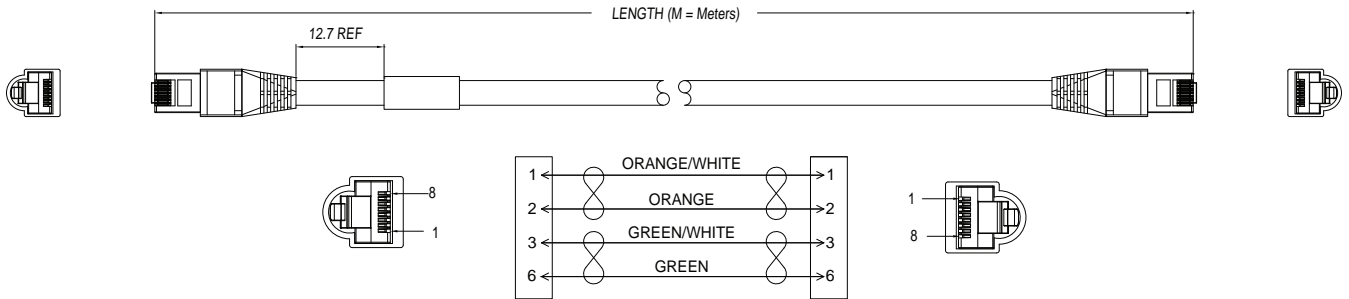

FIG 2: P29933-Mxxx, RJ45 to RJ45, Male, Teal

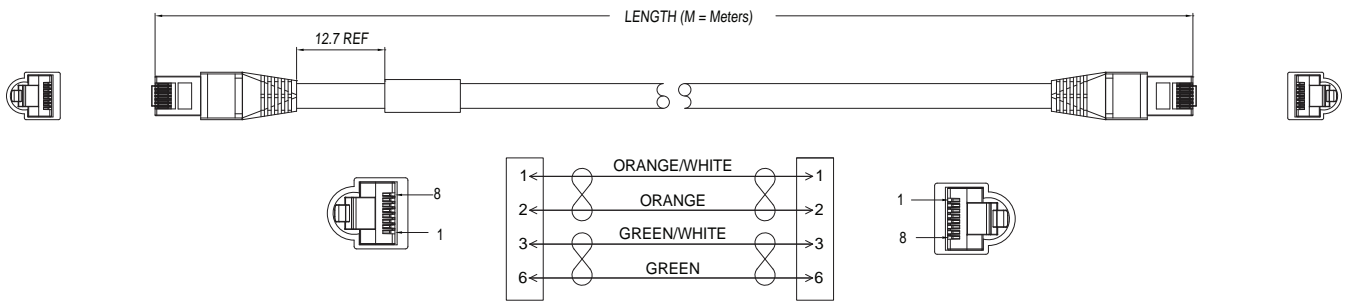

FIG 3: P29934-Mxxx, Ethernet M12, Male to Male, Plug, Blue

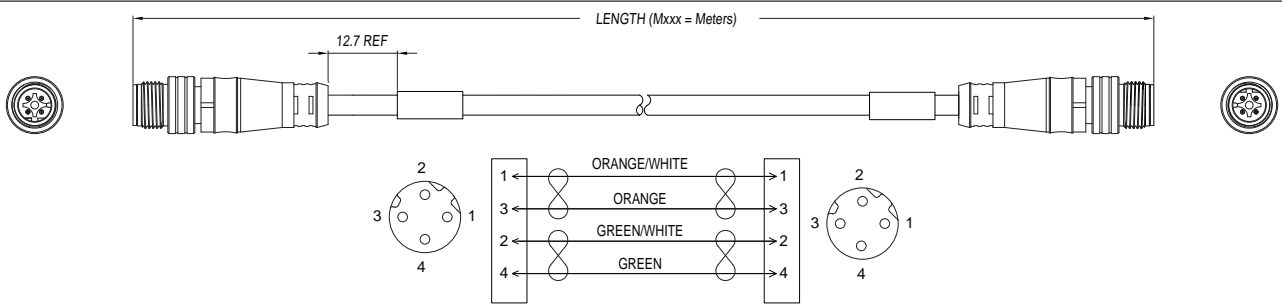
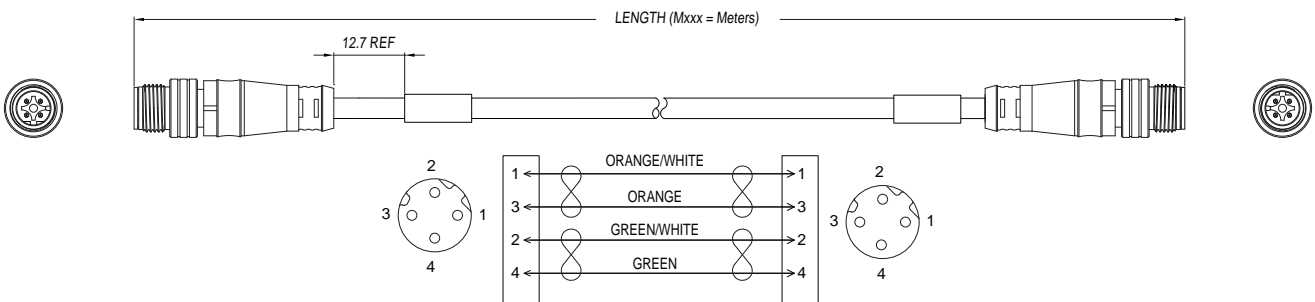

FIG 4: P29935-Mxxx, Ethernet M12, Male to Male, Plug, Teal



All Dimensions in: mm [inch]

# Ethernet M12



## Dimensional Drawings

Mxxx = length in meters

**FIG 5:** P29936-Mxxx, Ethernet M12, Male to Male, Plug, Orange

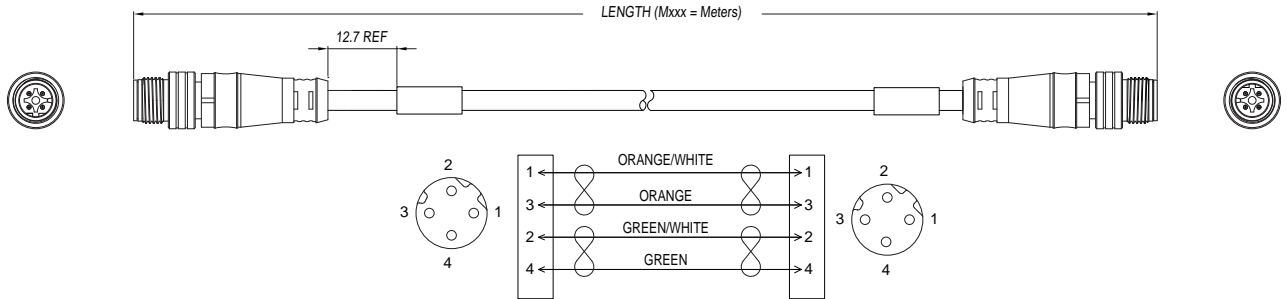

**FIG 6:** P29930-Mxxx, Ethernet M12, Female Receptacle to RJ45, Blue

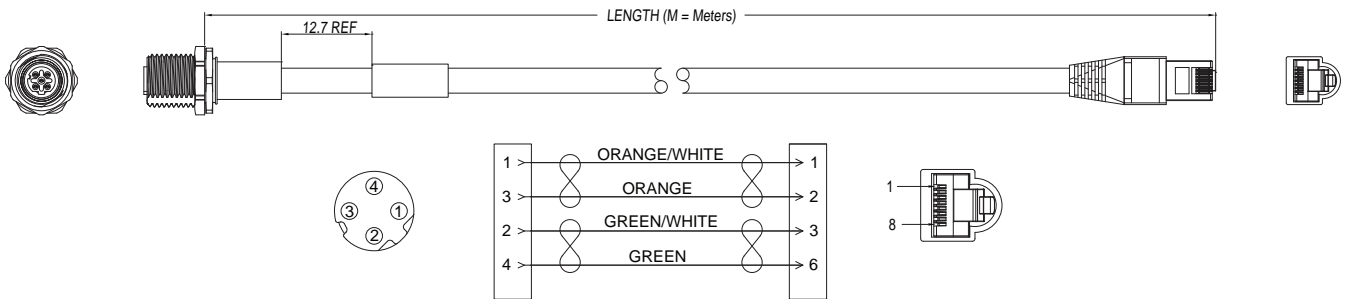

**FIG 7:** P29931-Mxxx, Ethernet M12, Female to Female, Receptacle, Orange

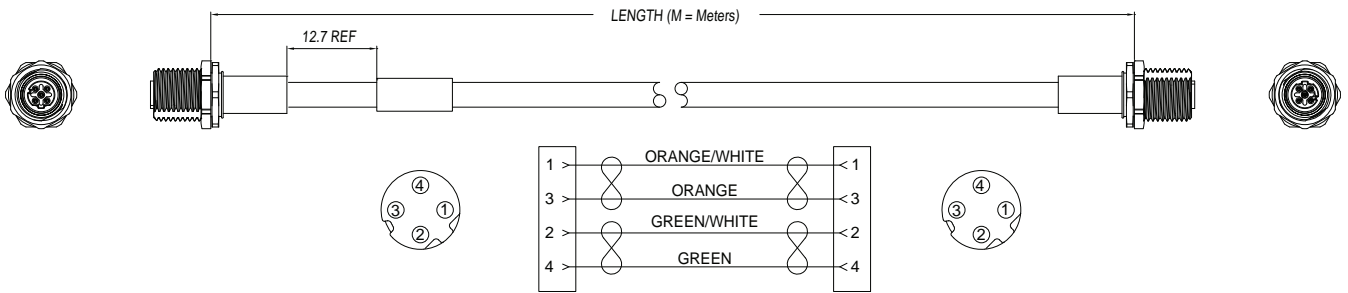

## Part Number Index

10-54938.....	90	MC57A4BD02Mxx .....	97	MN51PD01Mxx .....	97
10-80249.....	38	MC57AC05Mxx .....	93	MN51PD02Mxx .....	97
34-80289.....	38	MC57AC09Mxx .....	93	MN51PW02Mxxx .....	89
MC31PW03Mxx .....	93	MC57AD02Mxx.....	97	MN52PW02Mxxx .....	89
MC34AC05Mxx .....	93	MC57B4AC05Mxxx .....	93	MN53AC01Mxxx .....	89
MC34BC05Mxx .....	93	MC57B4AC09Mxxx .....	93	MN53BC01Mxxx .....	89
MC34PW03Mxx .....	93	MC57B4AD02Mxx .....	97	MN54AC01Mxxx .....	89
MC37A4AC05Mxxx .....	93	MC57B4BC05Mxxx .....	93	MN54AD01Mxx .....	97
MC37A4BC05Mxxx .....	93	MC57B4BC09Mxxx .....	93	MN54AD02Mxx .....	97
MC37AC05Mxx .....	93	MC57B4BD02Mxx .....	97	MN54BC01Mxxx .....	89
MC37B4AC05Mxxx .....	93	MC57BC05Mxx .....	93	MN54BD01Mxx .....	97
MC37B4BC05Mxxx .....	93	MC57BC09Mxx .....	93	MN54BD02Mxx .....	97
MC37BC05Mxx.....	93	MC57BD02Mxx .....	97	MN54PD01Mxx .....	97
MC41PW03Mxx .....	93	MN21PW02Mxxx.....	89	MN54PD02Mxx .....	97
MC44AC05Mxx .....	93	MN22PW02Mxxx .....	89	MN54PW02Mxxx .....	89
MC44AC09Mxx .....	93	MN23AC01Mxxx .....	89	MN57A4AC01Mxxx .....	89
MC44BC05Mxx.....	93	MN23BC01Mxxx .....	89	MN57A4AD01Mxx .....	97
MC44BC09Mxx .....	93	MN24AC01Mxxx .....	89	MN57A4AD02Mxx .....	97
MC44PW03Mxx .....	93	MN24BC01Mxxx .....	89	MN57A4BC01Mxxx .....	89
MC47A4AC05Mxxx .....	93	MN24PW02Mxxx .....	89	MN57A4BD01Mxx .....	97
MC47A4AC09Mxxx .....	93	MN27A4AC01Mxxx .....	89	MN57A4BD02Mxx .....	97
MC47A4BC05Mxxx .....	93	MN27A4BC01Mxxx .....	89	MN57AD01Mxx .....	97
MC47A4BC09Mxxx .....	93	MN27B4AC01Mxxx .....	89	MN57AD02Mxx .....	97
MC47AC05Mxx .....	93	MN27B4BC01Mxxx .....	89	MN57B4AC01Mxxx .....	89
MC47AC09Mxx .....	93	MN31PW02Mxxx .....	89	MN57B4AD01Mxx .....	97
MC47B4AC05Mxxx .....	93	MN32PW02Mxxx .....	89	MN57B4AD02Mxx .....	97
MC47B4AC09Mxxx .....	93	MN33AC01Mxxx .....	89	MN57B4BC01Mxxx .....	89
MC47B4BC05Mxxx .....	93	MN33BC01Mxxx .....	89	MN57B4BD01Mxx .....	97
MC47B4BC09Mxxx .....	93	MN34AC01Mxxx .....	89	MN57B4BD02Mxx .....	97
MC47BC05Mxx .....	93	MN34BC01Mxxx .....	89	MN57BD01Mxx .....	97
MC47BC09Mxx.....	93	MN34PW02Mxxx .....	89	MN57BD02Mxx .....	97
MC51PD02Mxx .....	97	MN37A4AC01Mxxx .....	89	MN61PW02Mxxx .....	89
MC51PW03Mxx .....	93	MN37A4BC01Mxxx .....	89	MN62PW02Mxxx .....	89
MC54AC05Mxx .....	93	MN37B4AC01Mxxx .....	89	MN63AC01Mxxx .....	89
MC54AC09Mxx .....	93	MN37B4BC01Mxxx .....	89	MN63BC01Mxxx .....	89
MC54AD02Mxx.....	97	MN41PW02Mxxx.....	89	MN64AC01Mxxx .....	89
MC54BC05Mxx.....	93	MN42PW02Mxxx.....	89	MN64BC01Mxxx .....	89
MC54BC09Mxx.....	93	MN43AC01Mxxx.....	89	MN64PW02Mxxx.....	89
MC54BD02Mxx .....	97	MN43BC01Mxxx .....	89	MN67A4AC01Mxxx .....	89
MC54PD02Mxx .....	97	MN44AC01Mxxx .....	89	MN67A4BC01Mxxx .....	89
MC54PW03Mxx .....	93	MN44BC01Mxxx .....	89	MN67B4AC01Mxxx .....	89
MC57A4AC05Mxxx .....	93	MN44PW02Mxxx.....	89	MN67B4BC01Mxxx .....	89
MC57A4AC09Mxxx .....	93	MN47A4AC01Mxxx .....	89	MN651PW02-Mxxx.....	85
MC57A4AD02Mxx.....	97	MN47A4BC01Mxxx .....	89	MN654AC07-Mxxx.....	85
MC57A4BC05Mxxx .....	93	MN47B4AC01Mxxx .....	89	MN654BC07-Mxxx .....	85
MC57A4BC09Mxxx .....	93	MN47B4BC01Mxxx .....	89	MN654PW02-Mxxx.....	85

## Part Number Index

MN657A4AC07-Mxxx.....	85	P28974.....	19	P29042.....	19
MN657A4BC07-Mxxx.....	85	P28976-Mxxx.....	17	P29043.....	19
MN657AC07-Mxxx.....	85	P28977-Mxxx.....	17	P29044.....	19
MN657B4AC07-Mxxx.....	85	P28978-Mxxx.....	18	P29044.....	29
MN657B4BC07-Mxxx.....	85	P28979-Mxxx.....	18	P29044.....	86
MN657BC07-Mxxx.....	85	P28984-Mxxx.....	17	P29044.....	90
P27779.....	51	P28985-Mxxx.....	17	P29044.....	98
P27784-Mxxx.....	50	P28986-Mxxx.....	18	P29045.....	19
P27785-Mxxx.....	50	P28987-Mxxx.....	18	P29045.....	29
P27786-Mxxx.....	50	P28992-Mxxx.....	16	P29045.....	86
P27787-Mxxx.....	50	P28993-Mxxx.....	16	P29045.....	90
P27790-Mxxx.....	50	P28996-Mxxx.....	17	P29045.....	98
P27791-Mxxx.....	50	P28997-Mxxx.....	17	P29057-Mxxx.....	18
P27792-Mxxx.....	50	P29000-Mxxx.....	16	P29059-Mxxx.....	18
P27793-Mxxx.....	50	P29001-Mxxx.....	16	P29309.....	90
P27796-Mxxx.....	50	P29004-Mxxx.....	17	P29310.....	90
P27797-Mxxx.....	50	P29005-Mxxx.....	17	P29311.....	90
P27891.....	51	P29008-Mxxx.....	28	P29312.....	98
P28375.....	51	P29009-Mxxx.....	28	P29313.....	86
P28559-Mxxx.....	50	P29010-Mxxx.....	28	P29318.....	98
P28560-Mxxx.....	50	P29011-Mxxx.....	29	P29319.....	98
P28561-Mxxx.....	50	P29012-Mxxx.....	28	P29325.....	86
P28562-Mxxx.....	50	P29013-Mxxx.....	28	P29326.....	86
P28571-Mxxx.....	50	P29014-Mxxx.....	28	P29328.....	86
P28572-Mxxx.....	50	P29015-Mxxx.....	29	P29329.....	98
P28573.....	51	P29016-Mxxx.....	27	P29332.....	94
P28574.....	51	P29017-Mxxx.....	27	P29333.....	94
P28625.....	51	P29018-Mxxx.....	28	P29334.....	94
P28810.....	61	P29019-Mxxx.....	28	P29359-Mxxx.....	18
P28815.....	61	P29020-Mxxx.....	27	P29360-Mxxx.....	18
P28816-Mxxx.....	60	P29021-Mxxx.....	27	P29361-Mxxx.....	18
P28817-Mxxx.....	60	P29022-Mxxx.....	28	P29364.....	18
P28818-Mxxx.....	60	P29023-Mxxx.....	28	P29841.....	42
P28819-Mxxx.....	60	P29024-Mxxx.....	18	P29844-Mxxx.....	42
P28820.....	61	P29026-Mxxx.....	18	P29845.....	43
P28821.....	61	P29028-Mxxx.....	18	P29848-Mxxx.....	42
P28822-Mxxx.....	60	P29030-Mxxx.....	18	P29850.....	43
P28823-Mxxx.....	60	P29032-Mxxx.....	18	P29851.....	38
P28825.....	61	P29034-Mxxx.....	18	P29851.....	43
P28826.....	61	P29036-Mxxx.....	29	P29855.....	18
P28827.....	61	P29037-Mxxx.....	29	P29858.....	19
P28964.....	18	P29038-Mxxx.....	29	P29930-Mxxx.....	103
P28966.....	18	P29039-Mxxx.....	29	P29931-Mxxx.....	103
P28968.....	19	P29040.....	19	P29932-Mxxx.....	103
P28970.....	19	P29041.....	19	P29933-Mxxx.....	103
P28972.....	19	P29041.....	29	P29934-Mxxx.....	103

## Part Number Index

P29935-Mxxx	103	P30672-Mxxx	36	P30862	18
P29936-Mxxx	103	P30706-Mxxx	80	P30863	19
P29950-Mxxx	42	P30707-Mxxx	80	P30864	18
P29954-Mxxx	42	P30708-Mxxx	80	P30865	19
P30066-Mxxx	42	P30709-Mxxx	80	P30866	18
P30141	37	P30710-Mxxx	72	P30867	19
P30142-Mxxx	37	P30711-Exxx/Mxxx	72	P30868	19
P30143-Mxxx	37	P30712-Mxxx	72	P30869	18
P30146-Mxxx	37	P30713-Mxxx	72	P30870	19
P30147-Mxxx	37	P30715	37	P30871	19
P30163-Mxxx	37	P30716	18	P30881-Mxxx	17
P30164	38	P30717	19	P30882-Mxxx	16
P30165-Mxxx	76	P30727-Mxxx	29	P30883-Mxxx	16
P30166-Exxx/Hxxx	77	P30746-Mxxx	29	P30884-Mxxx	17
P30167-Exxx/Hxxx	77	P30748-Mxxx	17	P30885-Mxxx	16
P30189-Mxxx	37	P30749-Mxxx	17	P30886-Mxxx	16
P30237-Mxxx	36	P30750-Mxxx	17	P30887-Mxxx	17
P30238-Mxxx	36	P30751-Mxxx	17	P30888-Mxxx	17
P30239-Mxxx	36	P30752-Mxxx	16	P30889-Mxxx	28
P30240-Mxxx	36	P30753-Mxxx	16	P30890-Mxxx	27
P30241-Mxxx	36	P30754-Mxxx	16	P30891-Mxxx	27
P30242-Mxxx	36	P30755-Mxxx	16	P30892-Mxxx	28
P30253-Mxxx	17	P30756-Mxxx	28	P30893-Mxxx	27
P30254-Mxxx	28	P30757-Mxxx	28	P30894-Mxxx	27
P30256-Mxxx	37	P30758-Mxxx	28	P30895-Mxxx	28
P30257-Mxxx	37	P30759-Mxxx	28	P30896-Mxxx	28
P30412-Mxxx	80	P30760-Mxxx	27	P30965	86
P30510	38	P30761-Mxxx	27	P31000	18
P30510	43	P30762-Mxxx	27	P31001	18
P30538-Mxxx	72	P30763-Mxxx	27	P31002	18
P30539-Exxx/Hxxx	73	P30764-Mxxx	17		
P30540-Exxx/Hxxx	73	P30765-Mxxx	17		
P30544-Exxx/Hxxx	81	P30766-Mxxx	17		
P30545-Exxx/Hxxx	81	P30767-Mxxx	17		
P30552-Mxxx	76	P30768-Mxxx	16		
P30553-Mxxx	76	P30769-Mxxx	16		
P30618-Mxxx	80	P30770-Mxxx	16		
P30619-Mxxx	72	P30771-Mxxx	16		
P30648-Mxxx	76	P30772-Mxxx	28		
P30664-Mxxx	76	P30773-Mxxx	28		
P30665-Mxxx	76	P30774-Mxxx	28		
P30667-Mxxx	37	P30775-Mxxx	28		
P30668-Mxxx	36	P30776-Mxxx	27		
P30669-Mxxx	36	P30777-Mxxx	27		
P30670-Mxxx	37	P30778-Mxxx	27		
P30671-Mxxx	36	P30779-Mxxx	27		

www.amphenol-sine.com

## USA

**Amphenol Sine Systems**  
44724 Morley Drive  
Clinton Township, MI 48036  
Toll-Free: 1-800-394-7732  
Fax: 1-586-465-1216  
Email: [csr@amphenol-sine.com](mailto:csr@amphenol-sine.com)  
[www.amphenol-sine.com](http://www.amphenol-sine.com)

## Germany

**Amphenol Tüchel GmbH**  
August-Haeusser-Strasse 10  
Heilbronn, Germany 74080  
Phone: 49(0)-7131-929-0  
Fax: 49(0)-7131-929-486  
Email: [info@amphenol.de](mailto:info@amphenol.de)  
[www.amphenol.de](http://www.amphenol.de)

## China

**Amphenol Sine Systems**  
Building 21, 1st Liao Keng Industrial Zone,  
Shi Yan Street, Bao An District  
Shenzhen, China 518180  
Tel: 86-755-8173-8000 ext. 8098  
Fax: 86-755-8173-8180  
[www.amphenol-sine.com.cn](http://www.amphenol-sine.com.cn)

## USA

**Amphenol Corporation**  
**Corporate Headquarters**  
358 Hall Ave  
Wallingford Ct 06492  
Phone: (877) 267-4366  
[www.amphenol.com](http://www.amphenol.com)

## Mexico

**Prolongacion Reforma 61-6 B2**  
Col. Paseo de las Lomas  
C.P. 01330 Mexico DF, Mexico  
Phone: 52-55-5258-9984  
Fax: 52-55-5081-6890  
Email: [info@amphenolmexico.com](mailto:info@amphenolmexico.com)  
[www.amphenolmexico.com](http://www.amphenolmexico.com)

## Argentina

**Amphenol ARGENTINA**  
Avenida Callao 930  
2nd floor Office B Plaza  
C1023AAP Buenos Aires, Argentina  
Phone: 54-11-4815-6886  
Fax: 54-11-4814-5779  
Email: [info@amphenol.com.ar](mailto:info@amphenol.com.ar)  
[amphenol.com.ar](http://amphenol.com.ar)

## Brazil

**Amphenol do Brasil Ltda**  
Rua Diogo Moreira, 132  
20 Andar, Rooms 2001-2-3  
CEP 05423-101  
Sao Paulo- SP, Brazil  
Phone: 55-11-3815-1003  
Fax: 55-11-3815-1629  
[www.amphenol.com.br](http://www.amphenol.com.br)

## France

**Amphenol SOCAPEX**  
948, Promenade de l'Arve - BP 29  
74311 Thyez CEDEX, France  
Phone: 33(0)4-50-89-28-40  
Fax: 33(0)4-50-96-29-75  
[www.amphenol-socapex.com](http://www.amphenol-socapex.com)

## United Kingdom

**Amphenol LIMITED**  
Thanet Way, Whitstable  
Kent CT5 3JF, United Kingdom  
Phone: 44-1-227-773200  
Fax: 44-1-227-276571  
[www.amphenol.co.uk](http://www.amphenol.co.uk)

## Australia

**Amphenol AUSTRALIA PTY LIMITED**  
2 Fiveways Blvd., Keysborough  
Melbourne, Victoria 3173 Australia  
Phone: 613-8796-8888  
Fax: 613-8796-8801  
[www.amphenol.com.au](http://www.amphenol.com.au)

## Turkey

**Amphenol International Ltd Turkey**  
Sun Plaza Kat. 15  
Maslak Mah. Bilim Sok. No. 5  
34398 Sisli / Istanbul – Turkey  
Tel: + 90 212 367.92.20  
Fax: + 90 212 367.92.21  
[www.amphenol.com.tr](http://www.amphenol.com.tr)

## South Africa

**Amphenol International Ltd**  
**South Africa**  
30 Impala Road  
2196 Sandton, Chislehurst  
South Africa  
Phone: 27-11-783-9517  
Fax: 27-11-783-9519  
Email: [sales@amphenolafrica.com](mailto:sales@amphenolafrica.com)  
[www.amphenol.com.za](http://www.amphenol.com.za)

## India

**Amphenol INTERCONNECT INDIA PVT LTD**  
105 Bhosari Industrial Area  
Pune 411 026, India  
Phone: +91 20 67360304  
Fax: +91 20 67360321  
[www.amphenol-in.com](http://www.amphenol-in.com)

## Korea

**Amphenol DAESHIN**  
558. Songnae-2 Dong. SoSa-Gu  
Bucheon City, Gyeonggi-do,  
Korea 422-818  
Phone: 81-32-610-3800  
Fax: 81-32-673-2507  
Email: [info@amphenol.co.kr](mailto:info@amphenol.co.kr)  
[www.amphenol.co.kr](http://www.amphenol.co.kr)

## Japan

**Amphenol JAPAN**  
471-1, Deba, Ritto-city  
shiga 520-3041, Japan  
Phone: 81-77-553-8501  
Fax: 81-77-551-2200  
[www.amphenol.co.jp](http://www.amphenol.co.jp)

## Russia

**Amphenol RUSSIA**  
8 Yaroslavskaja Street  
129164 Moscow, Russia  
Phone: 7495-937-6341  
Fax: 7495-937-6319  
[www.amphenol.ru](http://www.amphenol.ru)



## X-ON Electronics

Largest Supplier of Electrical and Electronic Components

*Click to view similar products for [AC Power Leads](#) category:*

*Click to view products by [Amphenol](#) manufacturer:*

Other Similar products are found below :

[62500-1774](#) [1300000023](#) [312033-01](#) [YP-61+YC12](#) [P28818-M2](#) [YP21A+YC13](#) [FTP-629Y603](#) [1702002600](#) [1700001947](#) [J2014004L001-CC](#)  
[SHELF](#) [IL13-EU1-H05-3100-300-S](#) [P28976-M45](#) [BB-3271V86](#) [W-97277](#) [W-97278](#) [W-97279](#) [W-97204](#) [W-97895](#) [W-98437](#) [W-98452](#) [W-](#)  
[98453](#) [MWOC-PCA-3-3-2](#) [P29844-M5](#) [P29844-M10](#) [CP152](#) [CP154](#) [W-99245](#) [W-99246](#) [W-99249](#) [W-99251](#) [W-99252](#) [W-99253](#) [W-99254](#)  
[W-99257](#) [W-99260](#) [W-99262](#) [W-99265](#) [W-99267](#) [W-99269](#) [W-99270](#) [W-99272](#) [W-99280](#) [W-99282](#) [S144720002](#) [S002020062](#)  
[S007220315](#) [S007220344](#) [S007220303](#) [S007220307](#) [P28818-M6](#)