

THIS DOCUMENT IS SUBJECT TO CHANGE WITHOUT NOTICE. IT IS CONFIDENTIAL AND A PROPERTY OF Amphenol LTW. DISCLOSURE TO THIRD PARTY HAS TO BE AUTHORIZED BY Amphenol LTW.

REV.	ECN NO.	DATE	SIGN	DESCRIPTION

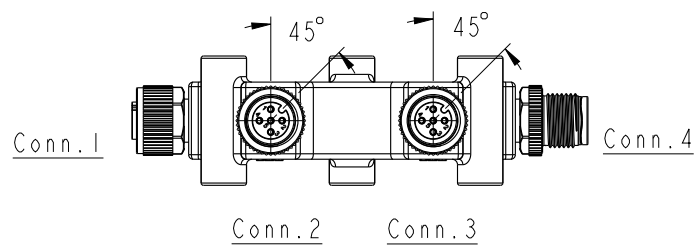

**ALTW**  
**CONFIDENTIAL**  
 2016-01-05  
**R&D DEPT.**

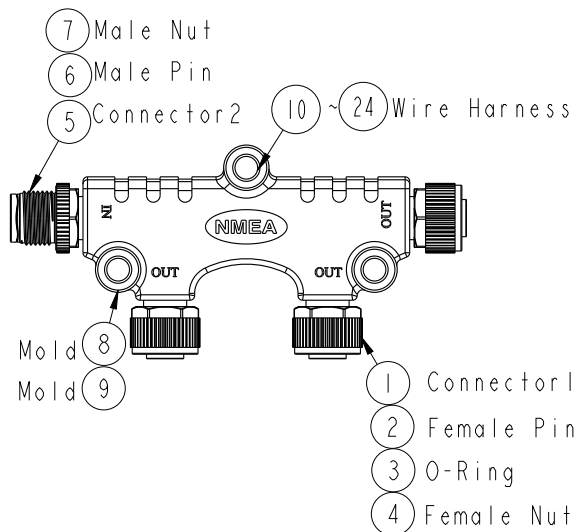
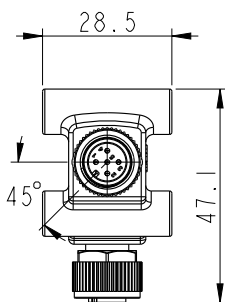
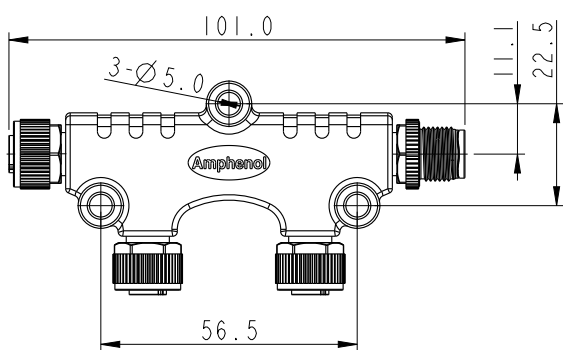
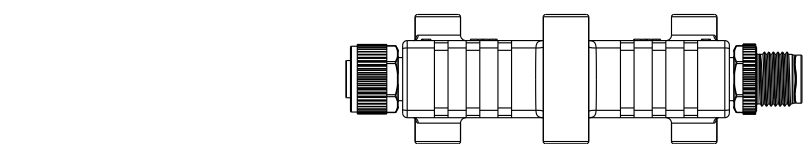
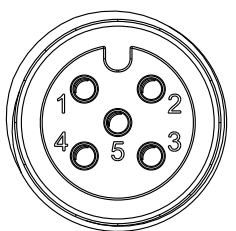

Conn.1&2&3  
Pin Assignments  
Front View

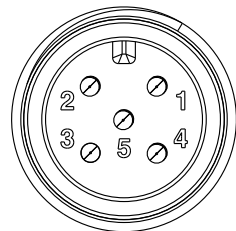

Conn.4  
Pin Assignments  
Front View

Blue 藍	5	5	5	5
White 白	4	4	4	4
Black 黑	3	3	3	3
Red 紅	2	2	2	2
Green 綠	1	1	1	1
Wire Color	Conn.1	Conn.2	Conn.3	Conn.4
	Pin Out			

Note:  
 \*  $\varnothing$  Important Dimension To Check.  
 \* Waterproof Rate: IP68  
 In 1 meter water within 24 hours  
 \* Connector: Pu, Black  
 \* Nut: PA66, Black  
 \* Pin: Copper Alloy, Gold Plated 30u"  
 \* Outer Mold: PU, Blue  
 \* Wire Harness: UL1061, 22AWG

UNIT:mm   
 TOLERANCE  
 ±0.50mm

TITLE NMEA2000 Micro-C 2-WAY TEE			
SCALE 1:1	SIZE A4	SHEET 1 OF 1	
REV. A	WC-REV. A.1	$\varnothing$ : Inspection item	

**Amphenol LTW**  
 安費諾亮泰企業股份有限公司

ITEM NO P-555500-FFFM00-S001	DRAWN BY Cary	DATE 2016-01-05
DWG NO P-555500-FFFM00-S001	CHECKED BY Yulong	DATE 2016-01-05
CUSTOMER ALTW	APPROVED BY Jerry	DATE 2016-01-05

## X-ON Electronics

Largest Supplier of Electrical and Electronic Components

*Click to view similar products for [Standard Circular Connector](#) category:*

*Click to view products by [Amphenol](#) manufacturer:*

Other Similar products are found below :

[5M2530B10P](#) [600259N006](#) [600273N007](#) [6134-336-13149](#) [6134-337-11149](#) [6134-337-2390](#) [6134-341-17149](#) [6280-4SG-516](#) [6280-7SG-3DC](#)  
[6290](#) [6291A](#) [66200A-10](#) [680-SMG](#) [681-PMG](#) [CXS3102A14S2P](#) [CXS3102A181S](#) [7251-6SG-300](#) [7271-6SG-300](#) [7282-3PG-300-CH3](#) [75-](#)  
[474014-05S](#) [75-474618-01S](#) [75-474618-04P](#) [75-474618-04S](#) [799539-000](#) [MI8-SE](#) [805-005-07NF11-19PC](#) [805-005-07NF15-7PA](#) [8280-4PG-](#)  
[516](#) [8280-7PG-519](#) [8282-5PG-519](#) [836783-1](#) [MP-4102-25P-C](#) [862256-1](#) [864019-2](#) [866857-1](#) [867865-1](#) [PT01SP-14-18P](#) [PT08P-14-5S](#)  
[PTSF06SE-14-12S](#) [120-1833-000](#) [QCM019PC2DC012B](#) [1-2069279-1](#) [121583-0217](#) [121667-0020](#) [129591AU](#) [1000B BULK](#) [RD10A16-19-](#)  
[P6CS051/1](#) [RD10A20-31-P8CS051/1](#) [RD16A14-12-S6CS051/2](#) [1301240290](#) [1301240347](#)