

THIS DRAWING IS SUPPLIED FOR INFORMATION ONLY. DESIGN FEATURES, SPECIFICATIONS AND PERFORMANCE DATA SHOWN HEREON ARE THE PROPERTY OF THE AMPHENOL CORPORATION. NO RIGHTS OF REPRODUCTION ARE IMPLIED. ALL DIMENSIONS ARE SUBJECT TO NORMAL MANUFACTURING VARIATIONS.

Customer Drawing

REVISIONS						
REV	ZONE	ECO	DESCRIPTION	DATE	BY	APPR
1	--	--	INITIAL RELEASE	11/21/13	RW	EC
A1	--	--	Updated Spec.	07/17/14	RW	EC
A2	--	--	Updated Back Cover	11/21/14	RW	EC
B	--	--	Change The Color of Press Key & Recommended Wire OD	03/04/15	RW	EC
B1	--	--	Add dimension of terminal	04/28/15	RW	EC
C	--	--	Add key abridged general view	09/17/15	RW	TS
D	--	--	Change pin for 4mm2 wire	11/03/15	RW	TS
E	--	--	Updated Spec.	11/08/16	SW	TS

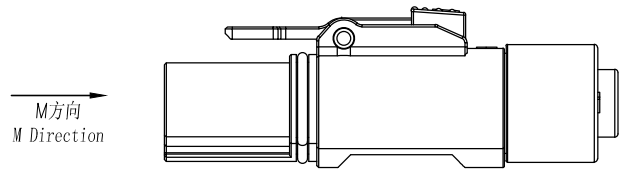
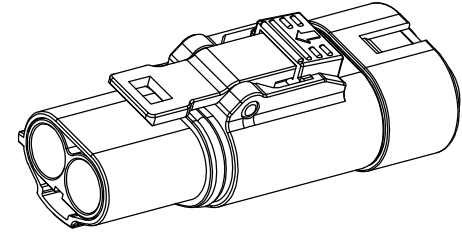
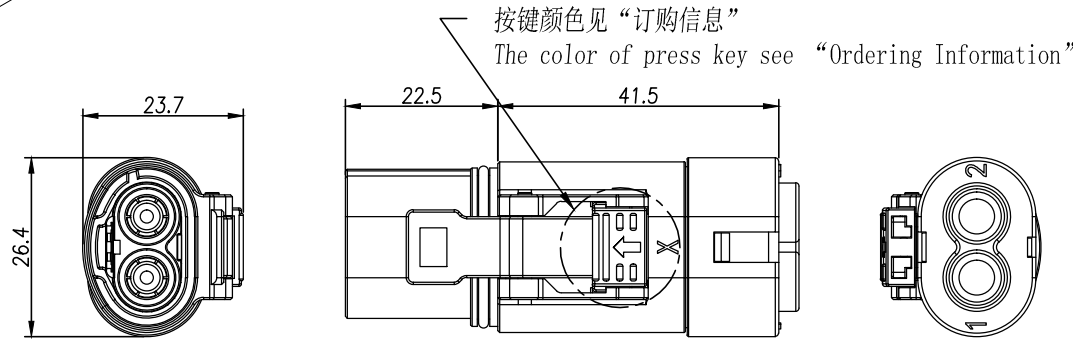

Standard Part List (With HVIL)

P/N	Model NO.	Recommended Wire OD	Dimension "A"	Mating Rcpt Model NO.
AC-HA000743	PL182X-61-2.5	5.0~5.4mm	φ4.00mm	PL082X-61-2.5
AC-HA000744	PL182Y-61-2.5			PL082Y-61-2.5
AC-HA000745	PL182U-61-2.5			PL082U-61-2.5
AC-HA000919	PL182X-61-4	5.6~6.0mm	△ φ4.57mm	PL082X-61-4
AC-HA000920	PL182Y-61-4			PL082Y-61-4
AC-HA000921	PL182U-61-4			PL082U-61-4

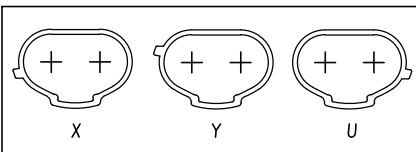

M方向键位示意图
Key Abridged General View of M Direction

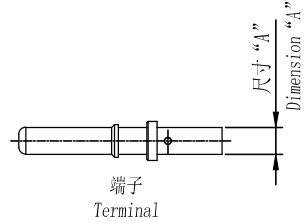

Standard Part List

P/N	Model NO.	Recommended Wire OD	Dimension "A"	Mating Rcpt Model NO.
AC-HA000746	PL182X-60-2.5	5.0~5.4mm	φ4.00mm	PL082X-60-2.5
AC-HA000747	PL182Y-60-2.5			PL082Y-60-2.5
AC-HA000748	PL182U-60-2.5			PL082U-60-2.5
AC-HA000922	PL182X-60-4	5.6~6.0mm	△ φ4.57mm	PL082X-60-4
AC-HA000923	PL182Y-60-4			PL082Y-60-4
AC-HA000924	PL182U-60-4			PL082U-60-4

规格参数 (Spec.):

1. 工作温度 Operating temperature: -40° C~+125° C.
2. 额定电流 Current rating (Connector Only): 60 A.
3. 额定电压 Operating voltage: 1000 VDC.
4. 耐电压 Dielectric withstanding voltage: 5000 VDC.
5. 防护等级 Protection class: IP67 & IP2X. △
6. 电磁屏蔽 Shielding.
7. 机械寿命 Mating cycle: 100 Min. △
8. 带自动二次锁扣 Automatic secondary lock.
9. 带高压互锁 Electrical interlock (HVIL).
10. 对插座见图纸 Mating receptacle see drawing: "PL082-60".

订购信息 Ordering Information

PL18 2 X - 6 1 - 4

键位及颜色 Key & Color "X", 橙色 Orange "Y", 黑色 Black "U", 黄色 Yellow	高压互锁 HVIL 0, 不带互锁 No HVIL 1, 带互锁 With HVIL	线缆大小 Cable Size "4"=4mm ² "2.5"=2.5mm ²
--	--	---

AMPHENOL TP	Amphenol Technical Products International GZ					PART NAME: PwrLok 4mm 2POS Plug Conn
	第三角投影 THIRD ANGLE PROJECTION	页面 SHEET	幅面 SIZE	版次 REV.	比例 SCALE	
签名 SIGNATURE	日期 DATE	UNLESS OTHERWISE SPECIFIED			DWG NO:	
制图 DRAWN	SW	1) All dimensions are in metric (mm). 2) Tolerances are as follows: 0 PL DEC ±1.00 1 PL DEC ±0.50 2 PL DEC ±0.20			PL182-60	
审核 CHECKED		Angles ±1°			CUST PART #: N/A	
批准 APPROVAL					CUST REV. -	

THIS DRAWING IS SUPPLIED FOR INFORMATION ONLY. DESIGN FEATURES, SPECIFICATIONS AND PERFORMANCE DATA SHOWN HEREON ARE THE PROPERTY OF THE AMPHENOL CORPORATION. NO RIGHTS OF REPRODUCTION ARE IMPLIED. ALL DIMENSIONS ARE SUBJECT TO NORMAL MANUFACTURING VARIATIONS.

Customer Drawing

REVISIONS						
REV	ZONE	ECO	DESCRIPTION	DATE	BY	APPR
1	--	--	INITIAL RELEASE	11/21/13	RW	EC
A1	--	--	Updated Spec.	07/17/14	RW	EC
A2	--	--	Updated Back Cover	11/21/14	RW	EC
B	--	--	Change The Color of Press Key & Recommended Wire OD	03/04/15	RW	EC
B1	--	--	Add dimension of terminal	04/28/15	RW	EC
C	--	--	Add key abridged general view	09/17/15	RW	TS
D	--	--	Change pin for 4mm2 wire	11/03/15	RW	TS
E	--	--	Updated Spec.	11/08/16	SW	TS

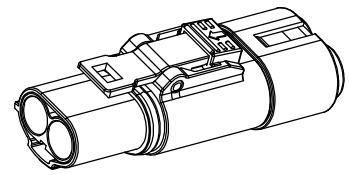
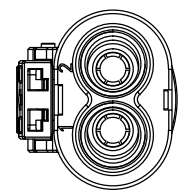
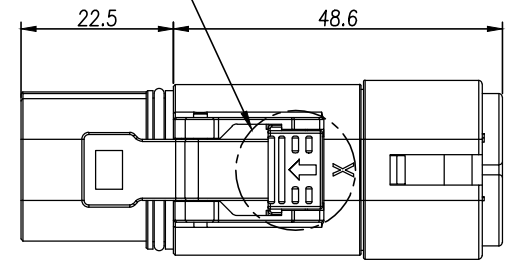
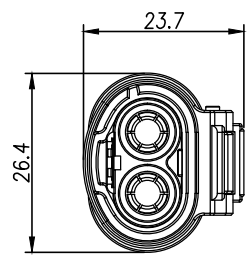

M方向
M Direction

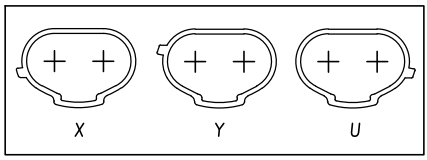
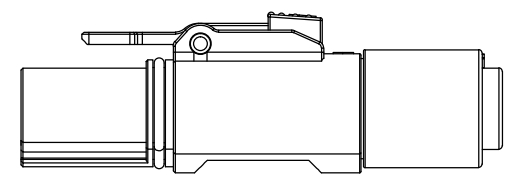

M方向键位示意图
Key Abridged General View of M Direction

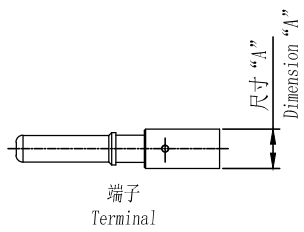

端子
Terminal

Standard Part List (With HVIL)

P/N	Model NO.	Recommended Wire OD	Dimension "A"	Mating Rept Model NO.
AC-HA000925	PL182X-61-6	6.4~7.0mm	φ5.80mm	PL082X-61-6
AC-HA000926	PL182Y-61-6			PL082Y-61-6
AC-HA000927	PL182U-61-6			PL082U-61-6
AC-HA001076	PL182X-61-10	8.3~8.9mm	φ7.40mm	PL082X-61-10
AC-HA001077	PL182Y-61-10			PL082Y-61-10
AC-HA001078	PL182U-61-10			PL082U-61-10

Standard Part List (Without HVIL)

P/N	Model NO.	Recommended Wire OD	Dimension "A"	Mating Rept Model NO.
AC-HA000928	PL182X-60-6	6.4~7.0mm	φ5.80mm	PL082X-60-6
AC-HA000929	PL182Y-60-6			PL082Y-60-6
AC-HA000930	PL182U-60-6			PL082U-60-6
AC-HA001079	PL182X-60-10	8.3~8.9mm	φ7.40mm	PL082X-60-10
AC-HA001080	PL182Y-60-10			PL082Y-60-10
AC-HA001081	PL182U-60-10			PL082U-60-10

规格参数 (Spec.):

1. 工作温度 Operating temperature: -40° C~+125° C.
2. 额定电流 Current rating (Connector Only): 60 A.
3. 额定电压 Operating voltage: 1000 VDC.
4. 耐电压 Dielectric withstanding voltage: 5000 VDC.
5. 防护等级 Protection class: IP67 & IP2X.
6. 电磁屏蔽 Shielding.
7. 机械寿命 Mating cycle: 100 Min.
8. 带自动二次锁扣 Automatic secondary lock.
9. 带高压互锁 Electrical interlock (HVIL).
10. 对配插座见图纸 Mating receptacle see drawing: "PL082-60".

订购信息 Ordering Information

PL18 2 X - 6 1 - 10

键位及颜色 Key & Color "X", 橙色 Orange "Y", 黑色 Black "U", 黄色 Yellow	高压互锁 HVIL 0, 不带互锁 No HVIL 1, 带互锁 With HVIL	线缆大小 Cable Size "10"=10mm ² "6"=6mm ²
--	--	---

	Amphenol Technical Products International GZ				
	第三角投影 THIRD ANGLE PROJECTION	页面 SHEET	幅面 SIZE	版次 REV.	比例 SCALE
签名 SIGNATURE	日期 DATE	UNLESS OTHERWISE SPECIFIED			DWG NO: PL182-60
制图 DRAWN	SW	1) All dimensions are in metric(mm). 2) Tolerances are as follows:			CUST PART #: N/A
审核 CHECKED		0 PL DEC ±1.00 1 PL DEC ±0.50 2 PL DEC ±0.20			CUST REV. -
批准 APPROVAL		Angles ±1°			

X-ON Electronics

Largest Supplier of Electrical and Electronic Components

Click to view similar products for [Heavy Duty Power Connectors](#) category:

Click to view products by [Amphenol](#) manufacturer:

Other Similar products are found below :

[6646058-2](#) [6646137-1](#) [6646138-1](#) [6646940-1](#) [6651091-1](#) [6651525-1](#) [6651529-1](#) [696475-1](#) [702-32-01109](#) [73080255059](#) [73080965046](#)
[7310205040001](#) [765-16-0080B](#) [765-18-0080D](#) [902-77-02113](#) [PS00/A0620/6300](#) [AN0024023](#) [154-42B7WM250](#) [MS3117-14AC](#) [1643543-1](#)
[1766966-1](#) [1791340000](#) [NLDFT-3-BL-L-S120-M40A](#) [NLDFT-N-W-L-C240-M40B](#) [1926015-1](#) [NLS-3-BL-C240-M40B](#) [NLS-N-W-C240-](#)
[M40B](#) [NPS-3-BL-T6](#) [2-1589900-8](#) [9300480317](#) [294-0091-01100](#) [296-0040-01100](#) [1-6609148-0](#) [A32595-0049](#) [1766249-1](#) [19000005132](#)
[1926016-1](#) [1-966831-8](#) [AN0024202](#) [AN0264023](#) [279-0841-10100A](#) [281-0334-00100A](#) [RMSB4](#) [419-2083-301](#) [LCDX4/0-14B-X](#) [075-8519-](#)
[001](#) [078238-1613](#) [07.470.3256.0](#) [09000005288](#) [09140240311](#)