

Amphenol PT/PT-SE MIL-DTL-26482 Series I

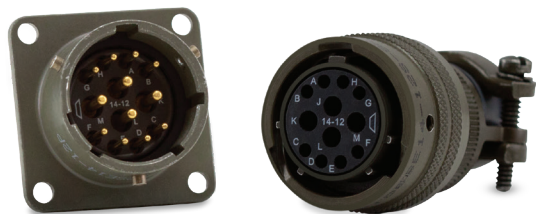

MATES WITH ITT CANNON AND SOURIAU MIL-DTL-26482

The Amphenol MIL-DTL-26482 Series I PT/PT-SE offers high-density contact arrangements in a circular shell. PT offers solder contacts, PT-SE offers high-performance crimp contacts, and PT-CE offers a commercial crimp option. These circular connectors provide quick-disconnect bayonet coupling for rapid mating and unmating, and several mounting styles and shell sizes.

- Intermateable, intermountable and interchangeable with all MIL-DTL-26482 connectors

APPLICATIONS

- Power generators
- Engines
- Sensors
- Motion control
- Off-road vehicles
- Earth-moving equipment
- Ships
- Mobile equipment
- Industrial machinery
- Telecommunications
- Traffic control

FEATURES

RUGGED SHELL

Aluminum alloy shell and hardware create a rugged connector with minimal weight. These connectors have been used extensively in commercial, military, and aerospace environments. Standard shells accept all MIL-DTL-26482 accessories.

ENVIRONMENTALLY-SEALED

Complete moisture sealing is achieved by combining four seals: shell, peripheral, interfacial, and wire. Wire seal is accomplished by multiple ripple design, exceeding the wire sealing requirements of MIL-DTL-26482.

RESISTANT TO MILITARY ENVIRONMENTS

These connectors will operate in temperatures from -67°F to +257°F (-55°C to +125°C) under the harshest possible conditions.

WIDE RANGE OF WIRE GAUGES AND CURRENT-CARRYING CAPACITY

Up to 23 amps with wire gauges from 24 to 12 AWG wire.

RESILIENT INSULATOR & GROMMET

A resilient neoprene insulator and integrated rear wire sealing grommet guarantees a liquid-tight assembly. Crimp contacts that can be inserted from the rear of the connector are available. Solder contacts are permanently bonded into the insulator.

SOLDER OR CRIMP GOLD-PLATED CONTACTS

PT connector contacts are gold-plated per MIL-G-45204 type II. PT-CE commercial crimp contacts are not military-approved, but the PT-SE crimp contacts are built in accordance to MIL-C-39029. Both types of contacts are crimped with the standard M22520/1 crimp tool. Socket contacts are closed to eliminate damage from test probes and to help prevent misaligned pins during engagement. Contact insertion is from the rear of the connector. When the contact is fully inserted, it snaps securely into retention tines embedded in the insulator. Contact extraction is accomplished from the front with the proper extraction tool. Pressing the tool plunger pushes the contact out through the rear of the connector.

AGENCY APPROVALS

- MIL-DTL-26482
- UL#E115497, for solder contacts only

**TECHNICAL
SPECIFICATIONS**
MATERIALS & FINISHES

Shell	Aluminum alloy
Plating	Anodic coating (alumilite), olive drab chromate over cadmium over nickel, electroless nickel, olive drab zinc, non-conductive black zinc, conductive black zinc and gray zinc nickel
Contacts	Copper alloy
Platings	Gold-plated, 50 microinches minimum per MIL-G-45204 type II.
Insulator	Resilient neoprene. PT-SE and PT-CE insulators encase a tough plastic wafer with contact retention tines for high-reliability retention of crimp contacts.

ELECTRICAL DATA

Operating Voltage & Test Voltage

SERVICE RATING*	TEST ALTITUDE	MAXIMUM OPERATING VOLTAGE		TEST VOLTAGE	
		DC	AC (RMS)	DC	AC (RMS)
1	Sea Level	850	600	2,100	1,500
2		1,400	1,000	3,200	2,300
1	70,000 feet	400	300	535	375
2		600	450	700	500

*Each insulator layout has a specific "service rating." The service ratings for each layout are listed on [pages 127, 129-131](#).

Current Rating

CONTACT SIZE	RATED CURRENT AMPS (MAX.)	TEST CURRENT AMPS (WORKING)	POTENTIAL DROP (MILLIVOLTS) INITIAL
20	13	7.5	< 55
16	22	13	< 50
12	41	23	< 42

Wire Range Sizes 24 to 12 AWG (and coax)

Contact Resistance When tested to MIL-STD-1344 Method 3004, will not exceed voltage drops listed in table. Consult MIL-DTL-26482, 3.6.4 for details.

Insulation Resistance 5,000 megohms minimum at 77°F (25°C)

MECHANICAL

Operating Temperature -67°F to +257°F (-55°C to +125°C)

Sealing 48 hours in 6 feet of water per MIL-DTL-26482 4.6.14.
Meets 10- and 20-day 50-95% humidity testing per MIL-STD-1344 Method 1002.2 per MIL-DTL-26482.

Wire Sealing Range: Per MIL-DTL-26482 1.4

CONTACT SIZE	AWG WIRE SIZE	INSULATION OUTSIDE DIAMETER LIMITS: INCHES (MM)		
		MIN. (PT)	MIN. (PT-SE/PT-CE)	MAX. (PT/PT-SE/PT-CE)
20	24, 22, and 20	.047 (1.19)	.047 (1.19)	.083 (2.11)
16	20, 18, and 16	.066 (1.68)	.066 (1.68)	.109 (2.77)
12	12 and 14	.097 (2.46)	.097 (2.46)	.142 (3.61)

Insulation Strip Lengths

CONTACT SIZE	WIRE SIZE (AWG)	STRIP LENGTH INCHES (MM)
20	20-24	.275 (7.0)
16	16-20	.250 (6.4)
12	12-14	.250 (6.4)

Mating Life	500 cycles minimum per MIL-DTL-26482 3.6.17
Salt Spray	Unmated connectors and protective covers meet 48-hour exposure to MIL-STD-1344 Method 1001 per MIL-DTL-26482. (Cadmium plating) Olive drab/black zinc, electroless nickel meets 48-hour salt spray test, gray zinc nickel meets 500-hour salt spray test.
Heat	+221°F (+105°C) for 1,000 hours per MIL-DTL-26482
Chemical Resistance	20-hour full-immersion unmated in hydraulic fluid and lubricating oil per MIL-DTL-26482.
Vibration	10 to 2,000Hz (15g's) 10 microseconds maximum discontinuity. To MIL-STD-1344 Method 2005 per MIL-DTL-26482.
Shock	50g's, 11ms duration, three major axes. 10 microseconds maximum discontinuity. To MIL-STD-1344 Method 2004 per MIL-DTL-26482.
Contact Type	Solder, crimp, printed circuit, thermocouple, coax
Number of Circuits	PT: 1 to 61; PT-SE & PT-CE: 2 to 61
Contact Insertion (Crimp)	Insertion from the rear of connector with simple hand-tool. Front release with appropriate extraction tool.
Contact Retention	To MIL-STD-1344 Method 2007 per MIL-DTL-26482.

CONTACT SIZE	AXIAL LOAD MIN. LBS (NEWTONS)
20	15 (66.7)
12 and 16	25 (111.2)

Polarization	Five keyway, three-point bayonet with optional rotational polarization. ↪ See pages 127, 129.
Approvals	<ul style="list-style-type: none"> MIL-DTL-26482H UL#E115497 (PT solder only)

EXCERPT FROM MIL-DTL-26482H

3.7.4 **JAN and J marking.** The United States Government has adopted and is exercising legitimate control over the certification marks "JAN" and "J", respectively, to indicate that items so marked or identified are manufactured to, and meet all the requirements of specifications. Accordingly, items acquired to, and meeting all of the criteria specified herein and in applicable specifications shall bear the certification mark "JAN" except that items too small to bear the certification mark "JAN" shall bear the letter "J". The "JAN" or "J" shall be placed immediately before the PIN except that if such location would place a hardship on the manufacturer in connection with such marking, the "JAN" or "J" may be located on the first line above or below the PIN. Items furnished under contracts or orders which either permit or require deviation from the conditions or requirements specified herein or in applicable specifications shall not bear "JAN" or "J". In the event an item fails to meet the requirements of this specification and the applicable specification sheets, the manufacturer shall remove completely the military PIN and the "JAN" or the "J" from the sample tested and also from all items represented by the sample. The "JAN" or "J" certification mark shall not be used on products acquired to contractor drawings or specification. The United States Government has obtained Certificate of Registration Number 504,860 for the certification mark "JAN" and Registration Number 1,586,261 for the certification mark "J".

PIN = Part Identification Number

CREATE YOUR **SOLDER** PART NUMBER USING THESE SIX STEPS

1	2	3	4	5
MS3116°	F°	16-26	P	W

SHELL STYLE **ENDBELL** **LAYOUT** **CONTACT** **ROTATION**
 (military part number example)

1	2	3	4	5	6
PT06*	E*	16-26	P	W	-SR

SHELL STYLE **ENDBELLS** **LAYOUT** **CONTACT** **ROTATION** **MODIFIER**
 (commercial part number example)

STEP 1: SELECT SHELL STYLE, PLUG OR RECEPTACLE

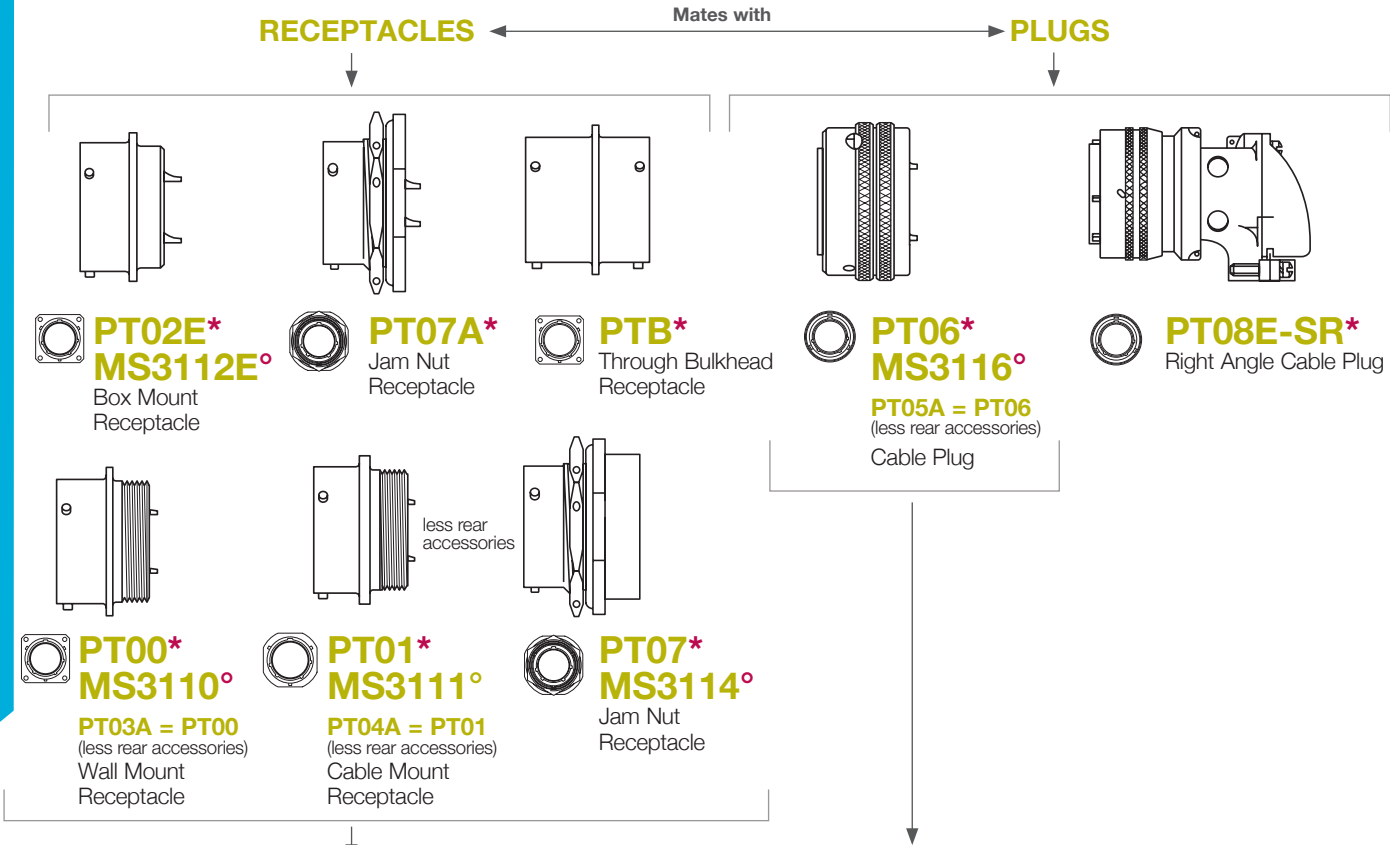

STEP 2: SELECT ENDBELL

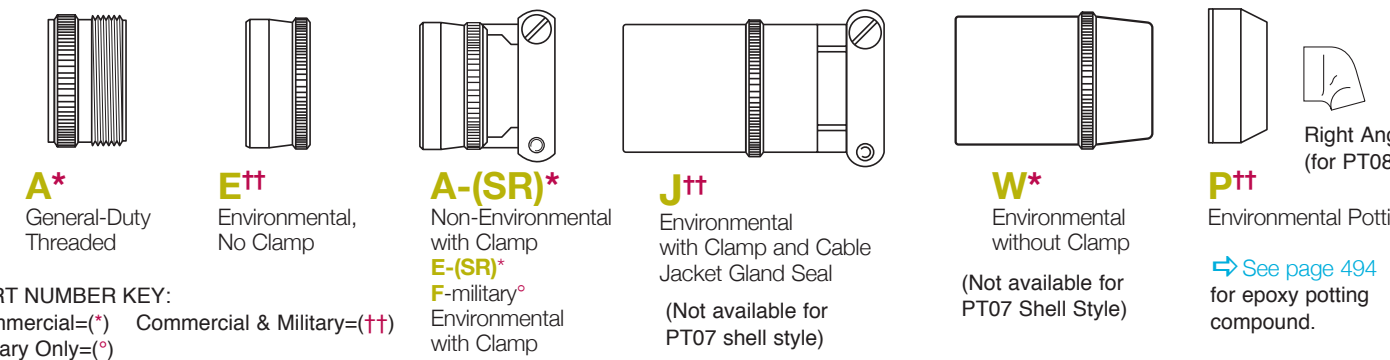

PART NUMBER KEY:
 Commercial=(*) Commercial & Military=(††)
 Military Only=(°)

STEP 3: SELECT LAYOUT

LAYOUT	SERVICE RATING	CONTACTS					ROTATIONS			
		TOTAL	20	16	12	COAX	W	X	Y	Z
6-1*	I	1	1				-	-	-	-
8-2 ^{††}	I	2	2				58	122	-	-
8-3 ^{††}	I	3	3				60	210	-	-
8-4 ^{††}	I	4	4				45	97 [#]	184 [#]	-
8-33*	I	3	3				90	-	-	-
8-98*	I	3	3				-	-	-	-
10-2*	I	2		2			45	90	315	-
10-5*	I	5	5				45	151	180	270
10-6 ^{††}	I	6	6				90	-	-	-
10-98 ^{††}	I	6	6				90	180	240	270
12-3 ^{††}	II	3		3			-	-	180	-
12-4*	I	4		4			38	-	-	-
12-8 ^{††}	I	8	8				90	112	203	292
12-10 ^{††}	I	10	10				60	155	270	295
12-14 A*	I	14	14				-	-	-	-
14-4 AS*	I	4			4		45	-	-	-
14-AA*U	I	4			4		45	-	-	-
14-5 ^{††}	II	5		5			40	92	184	273
14-12 ^{††}	I	12	8	4			43	90	-	-
14-15 ^{††}	I	15	14	1			17	110	155	234
14-18 ^{††}	I	18	18				15	90	180	270
14-19 ^{††}	I	19	19				30	165	315	-
14-91*	HV 5k	3	3				-	60	-	-
16-8 ^{††}	II	8		8			54	152	180	331
16-23 ^{††}	I	23	22	1			158	270	-	-
16-26 ^{††}	I	26	26				60	-	275	338
16-70	Coax	15	14			1	-	-	-	-
16-99 ^{††}	I	23	21	2			66	156	223	340
18-5*	II	5			5		55	97	263	315
18-11 ^{††}	II	11		11			62	119	241	340
18-30 ^{††}	I	30	29	1			180	193	285	350
18-32 ^{††}	I	32	32				85	138	222	265
20-16 ^{††}	II	16		16			238	318	333	347
20-24 ^{††}	I	24	24				70	145	215	290
20-25*	I	25	25				72	144	216	288
20-27 ^{††}	I	27	27				72	144	216	288
20-39 ^{††}	I	39	37	2			63	144	252	333
20-41 ^{††}	I	41	41				45	126	225	-
20-90*	HV	7	7				45	135	225	315
22-21 ^{††}	II	21		21			16	135	175	349
22-32 ^{††}	I	32	32				72	145	215	288
22-34*	I	34	34				62	142	218	298
22-36*	I	36	36				72	144	216	288
22-41 ^{††}	I	41	27	14			39	135	264	-
22-55 ^{††}	I	55	55				30	142	226	314
24-31A*	I	31		31			90	225	255	-
24-61 ^{††}	I	61	61				90	180	270	324

STEP 4: SELECT CONTACT

P = Pin S = Socket

STEP 5: SELECT ROTATION

See chart at left (Omit for normal)

W, X, Y, Z

STEP 6: SELECT MODIFIER

Default plating: Olive drab cadmium

- SR*** = F-Style Strain Relief (*not military*)
- 002*** = Black Anodized
- 005*** = Anodic Coating (*Alumilite*)
- 014*** = Olive Drab Chromate over Cadmium over Nickel (*500-hour salt spray*)
- 023*** = Electroless Nickel (*RoHS*)
- 024*** = Olive Drab Zinc Alloy
- 025*** = Black Alloy (*RoHS*)
- 027*** = Conductive Black Alloy (*RoHS*)
- 072** = Gray Zinc Nickel (*RoHS*)
- 424*** = Electroless Nickel and Strain Relief (*SR & 023*) (*RoHS*)
- 466*** = Olive Drab Zinc Alloy with Strain Relief (*SR & 024*)
- 470*** = Black Alloy with Strain Relief (*SR & 025*) (*RoHS*)
- 476*** = Conductive Black Alloy with Strain Relief (*SR & 027*) (*RoHS*)
- SCC*** = Self-Closing Cap Box Mount (*02*)
Shell sizes 8, 10, 12 & 18 only

PART NUMBER KEY:

Commercial=(*) Commercial & Military=(^{††})

= Commercial Rotation Only (Not Military)

A = A-Class Only

S = Socket Insert Only

U = 14-AA Insert Follows 14-4 MIL-STD-1669A contact spacing

CREATE YOUR **CRIMP** PART NUMBER USING THESE SIX STEPS

1	2	3	4	5
MS3126°	F°	16-26	P	W

SHELL STYLE

FINISH

LAYOUT

CONTACT

ROTATION

(military part number example)

1	2	3	4	5	6
PT06*	SE*	16-26	P	W	-SR

SHELL STYLE

ENDBELLS

LAYOUT

CONTACT

ROTATION

MODIFIER

(commercial part number example)

STEP 1: SELECT SHELL STYLE, PLUG OR RECEPTACLE

RECEPTACLES

Mates with

PLUGS

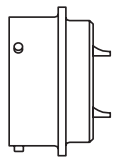

PT02SE*
PT02CE
MS3122E°
Box Mount Receptacle



PT00*
MS3120°
PT03SE = PT00SE
(less rear accessories)
Wall Mount Receptacle

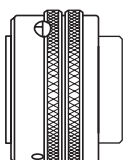

PT06*
MS3126°
PT05SE = PT06SE
(less rear accessories)
Cable Plug

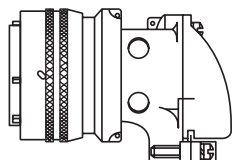

PT08SE-SR*
Right Angle Cable Plug

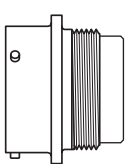

PT01*
MS3121°
PT04SE = PT01SE
(less rear accessories)
Cable Mount Receptacle

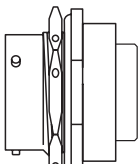

PT07*
MS3124°
Jam Nut Receptacle

STEP 2: SELECT ENDBELL



SE*
E°
Environmental No Clamp
CE††
Proprietary

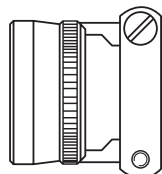

SE-(SR)*
CE-(SR)††
Add SR modifier to end of part number to call out the F-style endbell
F°
Environmental with Clamp

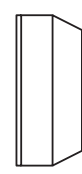

SP*
CP††
P°
Environmental Potting → See page 494 for epoxy potting compound.
Right Angle (for PT08SP)

PART NUMBER KEY:
SE=(*) CE=(††) Military=(°)

STEP 3: SELECT LAYOUT

LAYOUT	SERVICE RATING	TOTAL	CONTACTS					INSERT ROTATIONS			
			20	16	12	12 COAX	8 COAX	W	X	Y	Z
8-2††	I	2	2					58	122	-	-
8-3††	I	3	3					60	210	-	-
8-4††	I	4	4					45	97#	184#	-
8-33°	I	3	3					90	-	-	-
10-6††°	I	6	6					90	-	-	-
10-98††	I	6	6					90	180	240	270
12-3††°	II	3		3				-	-	180	-
12-8††°	I	8	8					90	112	203	292
12-10††°	I	10	10					60	155	270	295
14-5††°	II	5		5				40	92	184	273
14-12††°	I	12	8	4				43	90	-	-
14-15††°	I	15	14	1				17	110	155	234
14-18††°	I	18	18					15	90	180	270
14-19††°	I	19	19					30	165	315	-
14-22*	I	5	1		4			45	-	-	-
14-91*	HV 5k	3	3					-	60	-	-
16-8††°	II	8		8				54	152	180	331
16-23††°	I	23	22	1				158	270	-	-
16-26††°	I	26	26					60	-	275	338
16-76*	Coax	14	8		1	5		-	-	-	-
16-99°	I	23	21	2				66	156	223	340
18-5††*	II	5			5			55	97	263	315
18-11††*	II	11		11				62	119	241	340
18-30††°	I	30	29	1				180	193	285	350
18-32††°	I	32	32					85	138	222	265
18-80††	I/Coax	8	6				2	45	90	135	160
18-91††*	HV 5k	6	6					90	180	240	270
20-16††°	II	16		16				238	318	333	347
20-27††	I	27	27					72	144	216	288
20-39††°	I	39	37	2				63	144	252	333
20-41††°	I	41	41					45	126	225	-
22-7*	Coax	7					7	19	41	-	-
22-21††°	II	21		21				16	135	175	349
22-25*	I	25		25				60	125	211	336
22-32††	I	32	32					72	145	215	288
22-34††	I	34	34					62	142	218	298
22-36††	I	36	36					72	144	216	288
22-41††°	I	41	27	14				39	135	264	-
22-55††°	I	55	55					30	142	226	314
22-78*	Coax	7					7	19	41	-	-
22-96*	II	7			7			19	41	-	-
24-31††	I	31		31				90	225	255	-
24-38	I	38		38				85	138	222	265
24-51*	I/Coax	51	47		4			22	171	313	-
24-61††°	I	61	61					90	180	270	324

PART NUMBER KEY:

SE=(*) CE=(††) Military=(°)

= Commercial Rotation Only (Not Military)

STEP 4: SELECT CONTACT

P = Pin **S** = Socket

STEP 5: SELECT ROTATION

See chart at left (Omit for normal)

W, X, Y, Z

STEP 6: SELECT MODIFIER

Default plating: Olive Drab Cadmium

- SR*** = F-Style Strain Relief *not military*)
- 002*** = Black Anodized
- 005*** = Anodic Coating (*Alumilite*)
- 014*** = Olive Drab Chromate over Cadmium over Nickel (*500-hour salt spray, call for details*)
- 023*** = Electroless Nickel (*RoHS*)
- 024*** = Olive Drab Zinc Alloy
- 025*** = Non-Conductive Black Zinc Black Alloy (*RoHS*)
- 027*** = Conductive Black Alloy (*RoHS*)
- 072** = Gray Zinc Nickel (*RoHS*)
- 424*** = Electroless Nickel and Strain Relief (*SR & 023*) (*RoHS*)
- 466*** = Olive Drab Alloy with Strain Relief (*SR & 024*)
- 470*** = Black Alloy with Strain Relief (*SR & 025*) (*RoHS*)
- 476*** = Conductive Black Alloy with Strain Relief (*SR & 027*) (*RoHS*)
- SCC*** = Self-Closing Cap Box Mount (*02*)
Shell sizes 8,10, 12 & 18 only
- LC** = Less Contacts

LAYOUTS BY NUMBER OF CONTACTS

CONTACT LEGEND ○ =20 ● =16 ◐ =HV ◑ =12 ⊙ =coax
 Mating face view of pin inserts

SERIES LEGEND ▲ = PT-Solder △ = Solder: Military & PT ■ = PT-CE
 ◆ = PT-SE Crimp ◇ = Crimp: Military & PT-SE S = Socket only
 U = 14-44

CONTACTS	1	2	3			4					
SHELL SIZE/LAYOUT	6-1	8-2	10-2	8-3	8-33	8-98	12-3	14-91	8-4	12-4	14-4S
# OF CONTACTS	1-#20	2-#20	2-#16	3-#20	3-#20	3-#20	3-#16	3-HV	4-#20	4-#16	4-#12
SERIES	▲	■△	▲	■△	◆▲	▲	■◆△	▲	■△	▲	▲
SERVICE RATING	I	I	I	I	I	I	II	HV5k	I	I	I
CONTACTS	4			5			6				
SHELL SIZE/LAYOUT	14-AAU	18-76	10-5	14-5	14-22	18-5	10-6	10-98	18-91		
# OF CONTACTS	4-#12	4(coax)	5-#20	5-#16	4-#12; 1-#20	5-#12	6-#20	6-#20	6-HV		
SERIES	▲	■	▲	■◆◇	◆	■◆▲	■◆△	■△	■◆		
SERVICE RATING	I	(coax)	I	II	I	II	I	I	HV5k		
CONTACTS	7					8					
SHELL SIZE/LAYOUT	20-90	22-7	22-78	22-96	12-8	16-8					
# OF CONTACTS	7-HV	7(coax)	7(coax)	7-#12	8-#20	8-#16					
SERIES	▲	◆	◆	◆	■◆△	■◆△					
SERVICE RATING	I	II	II	HV5k	I	I					
CONTACTS	8	9	10	11	12						
SHELL SIZE/LAYOUT	18-80	22-71	12-10	18-11	14-12						
# OF CONTACTS	6-#20; 2(coax)	2-#20; 7(coax)	10-#20	11-#16	4-#16; 8-#20						
SERIES	■	■	■◆△	■◆△	■◆△						
SERVICE RATING	II(coax)	(coax)	I	II	I						
CONTACTS	14			15	16	18					
SHELL SIZE/LAYOUT	12-14	16-76	20-70	14-15	16-70	20-16	14-18				
# OF CONTACTS	14-#20	5-#12; 8-#20; 1(coax)	10-#20; 4(coax)	1-#16; 14-#20	1-#12(coax); 14-#20	16-#16	18-#20				
SERIES	▲	◆	■	■◆△	■▲	■◆△	■◆△				
SERVICE RATING	I	Size 12 (coax) User-Defined	I	II	not rated	I	I				

LAYOUTS BY NUMBER OF CONTACTS

CONTACT LEGEND ○ =20 ● =16 ◐ =HV ◑ =12 ⊙ =coax
Mating face view of pin inserts

SERIES LEGEND ▲ = PT-Solder △ = Solder: Military & PT
■ = PT-CE ◆ = PT-SE Crimp ◇ = Crimp: Military & PT-SE

CONTACTS	19	21	23	24	25
SHELL SIZE/LAYOUT	14-19	22-21	16-23	20-24	20-25
# OF CONTACTS	19-#20	21-#16	1-#16; 22-#20	24-#20	25-#20
SERIES	■ ◆ △	■ ◆ △	■ ◆ △	△	▲
SERVICE RATING	I	II	I	I	I



CONTACTS	25	26	27	30	31
SHELL SIZE/LAYOUT	22-25	16-26	20-27	18-30	24-31
# OF CONTACTS	25-#16	26-#20	27-#20	1-#16; 29-#20	31-#16
SERIES	◆	■ ◆ △	■ ◆ △	■ ◆ △	■ ▲
SERVICE RATING	I	I	I	I	I

CONTACTS	32	34	36	38	39
SHELL SIZE/LAYOUT	18-32	22-32	22-34	22-36	24-38
# OF CONTACTS	32-#20	32-#20	34-#20	36-#20	38-#16
SERIES	■ ◆ △	■ △	■ ▲	■ ▲	◆
SERVICE RATING	I	I	I	I	I

CONTACTS	41	51	55	61
SHELL SIZE/LAYOUT	20-41	22-41	24-51	22-55
# OF CONTACTS	41-#20	14-#16; 27-#20	4-#12(coax); 47-#20	55-#20
SERIES	■ ◆ △	■ ◆ △	◆	■ ◆ △
SERVICE RATING	I	I	I	I

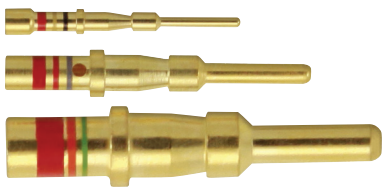
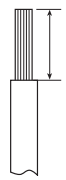
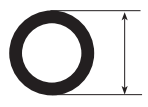
PIN & SOCKET CRIMP CONTACTS

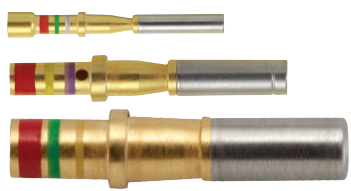
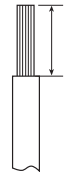
CONTACT & WIRE SIZE		PIN CONTACT & COLOR BANDS				WIRE STRIP LENGTH	WIRE SEALING RANGE	
								
CONTACT SIZE	WIRE SIZE AWG	PIN CONTACT PART NUMBER	COLOR BANDS			WIRE STRIP LENGTH	WIRE SEALING RANGE	
			1	2	3		MIN.	MAX.
SE CRIMP CONTACTS								
20	20-24	M39029/31-240	Red	Yellow	Black	.275 (7.0)	.047 (1.2)	.083 (2.1)
16	16-20	M39029/31-228	Red	Red	Grey	.250 (6.4)	.066 (1.7)	.109 (2.7)
12	12-14	M39029/31-235	Red	Orange	Green	.250 (6.4)	.097 (2.5)	.142 (3.6)
20 Chromel	20-24	10-330940-01P	-	-	-			
20 Alumel	20-24	10-330940-02P	-	-	-			
20 Iron	20-24	10-330940-03P	-	-	-	.250 (6.4)	.047 (1.2)	.083 (2.1)
20 Constantan	20-24	10-330940-04P	-	-	-			
CE CRIMP CONTACTS								
20	20-24	10-189000-20F	-	-	-	.275 (7.0)	.047 (1.2)	.083 (2.1)
20	16-20	10-195962-20F	-	-	-	.275 (7.0)	.047 (1.2)	.083 (2.1)
16	16-20	10-189004-16F	-	-	-	.250 (6.4)	.066 (1.7)	.109 (2.7)
20 Chromel	20-24	10-252900-01P	-	-	-			
20 Alumel	20-24	10-252900-02P	-	-	-			
20 Iron	20-24	10-252900-03P	-	-	-	.275 (7.0)	.047 (1.2)	.083 (2.1)
20 Constantan	20-24	10-252900-04P	-	-	-			

CONTACT & WIRE SIZE		SOCKET CONTACT & COLOR BANDS				WIRE STRIP LENGTH	WIRE SEALING RANGE	
								
CONTACT SIZE	WIRE SIZE AWG	SOCKET CONTACT PART NUMBER	COLOR BANDS			WIRE STRIP LENGTH	WIRE SEALING RANGE	
			1	2	3		MIN.	MAX.
SE CRIMP CONTACTS								
20	20-24	M39029/32-259	Red	Green	White	.275 (7.0)	.047 (1.2)	.083 (2.1)
16	16-20	M39029/32-247	Red	Yellow	Violet	.250 (6.4)	.066 (1.7)	.109 (2.7)
12	12-14	M39029/32-254	Red	Green	Yellow	.250 (6.4)	.097 (2.5)	.142 (3.6)
20 Chromel	20-24	10-330940-01S	-	-	-			
20 Alumel	20-24	10-330940-02S	-	-	-			
20 Iron	20-24	10-330940-03S	-	-	-	.250 (6.4)	.047 (1.2)	.083 (2.1)
20 Constantan	20-24	10-330940-04S	-	-	-			
CE CRIMP CONTACTS								
20	20-24	10-597817-351	-	-	-	.275 (7.0)	.047 (1.2)	.083 (2.1)
20	16-20	10-195963-20F	-	-	-	.275 (7.0)	.047 (1.2)	.083 (2.1)
16	16-20	10-189006-16F	-	-	-	.250 (6.4)	.066 (1.7)	.109 (2.7)
20 Chromel	20-24	10-252900-01S	-	-	-			
20 Alumel	20-24	10-252900-02S	-	-	-			
20 Iron	20-24	10-252900-03S	-	-	-	.275 (7.0)	.047 (1.2)	.083 (2.1)
20 Constantan	20-24	10-252900-04S	-	-	-			

All dimensions in inches (millimeters in parenthesis)

PIN & SOCKET CRIMP CONTACTS

WIRE HOLE FILLER		CRIMP TOOLS				INSERTION TOOL	EXTRACTION TOOL
		 <p>M22520/1-01 WA27F TH1A M22520/1-02</p>					
PART NUMBER	COLOR	HAND-CRIMP TOOL	POWER-CRIMP TOOL	TURRET HEAD	COLOR USE LOCATOR	INSERTION TOOL	EXTRACTION TOOL
SE CRIMP CONTACTS							
MS27488-20-2	Red	AF8 or M22520/1-01	WA27F*	TH1A or M22520/1-02	Red	M81969/17-03	M81969/19-07
MS27488-16-2	Blue				Blue	M81969/17-04	M81969/19-08
MS27488-12-2	Yellow				Yellow	M81969/17-05	M81969/19-09
MS27488-20-2	Red				Red	M81969/17-03	M81969/19-07
CE CRIMP CONTACTS							
MS27488-20-2	Red	AF8 or M22520/1-01	WA27F*	TH254	Red	11-6782	11-6900
MS27488-20-2	Red				Red	11-6782	
MS27488-16-2	Blue				Blue	11-6781	
MS27488-20-2	Red				Red	11-6782	
WIRE HOLE FILLER		CRIMP TOOLS				INSERTION TOOL	EXTRACTION TOOL
		 <p>AF8 WA27F TH1A M22520/1-02</p>					
PART NUMBER	COLOR	HAND-CRIMP TOOL	POWER-CRIMP TOOL	TURRET HEAD	COLOR USE LOCATOR	INSERTION TOOL	EXTRACTION TOOL
SE CRIMP CONTACTS							
MS27488-20-2	Red	AF8 or M22520/1-01	WA27F*	TH1A or M22520/1-02	Red	M81969/17-03	M81969/19-07
MS27488-16-2	Blue				Blue	M81969/17-04	M81969/19-08
MS27488-12-2	Yellow				Yellow	M81969/17-05	M81969/19-09
MS27488-20-2	Red				Red	M81969/17-03	M81969/19-07
CE CRIMP CONTACTS							
MS27488-20-2	Red	AF8 or M22520/1-01	WA27F*	TH254	Red	11-6782	11-6900
MS27488-20-2	Red				Red	11-6782	
MS27488-16-2	Blue				Blue	11-6781	
MS27488-20-2	Red				Red	11-6782	

*Contact us for more tool accessories.

PIN & SOCKET SOLDER COAX CONTACTS

CABLE	CONTACT PART #		FITS IN SHELL SIZE	OUTER SHELL CRIMP FERRULE		CLAMP NUT WRENCH
	PIN	SOCKET		MIL-C_22520/5-01 USE WITH DIE PART # (LOCATOR CAVITY)	MIL-C22520/10-01 USE WITH DIE PART# (LOCATOR CAVITY)	
CONTACT SIZE 12						
RG-161/U	21-033020-032	21-033019-032	10-18	M22520/5-03 (A)	M22520/10-05 (A)	11-8676-1
RG-174A/U				M22520/5-08 (A)		
RG-179B/U				M22520/5-35 (B)		
RG-187A/U				M22520/5-03 (B)	M22520/10-05 (B)	
RG-188A/U						
RG-316/U						
RG-196A/U	21-033020-031+	21-033061-031+				
"Thermatics 2929-29"	21-033020-033	21-033061-033		M22520/5-37 (B)		
CONTACT SIZE 8						
RG-58C/U	21-033020-002	21-033019-002	10-18	M22520/5-05 (B)	M22520/10-07 (B)	11-8676-2
RG-141A/U				M22520/5-41 (B)		
RG-303/U				21-033020-003	21-033019-003	
RG-59B/U	M22520/5-43 (B)	-	11-8676-2			
RG-62A/U						
RG-62B/U						
RG-210/U	21-033020-007*	21-033019-007*	10-18	M22520/5-03 (B)	M22520/10-05 (B)	11-8676-2
RG-142B/U				M22520/5-33 (B)		
Times MI51115	21-033020-004	21-033019-004	10-18	M22520/5-05 (B)	M22520/10-07 (B)	11-8676-2
RG-178B/U				M22520/5-41 (B)		
RG-180B/U				21-033020-005*	21-033019-005*	
RG-195A/U	M22520/5-41 (B)					
Raychem - 5022D1312-9	21-033020-006*	21-033019-006*	10-18	M22520/5-05 (B)	M22520/10-07 (B)	11-8676-2
Raychem - 5021D1331-9				M22520/5-41 (B)		
RG-59B/U	21-033020-001	21-033019-001	20-24	M22520/5-45 (B)	-	11-8676-3
RG-62A/U						
RG-62B/U						
RG-210/U						

Note: Solder contacts are supplied with outer contact body bonded into the insert (insulator). Contact us for wire strip lengths and assembly instructions

- * Please check availability
- + Only mate with one another

SOLDER (PT)

CRIMP (PT-SE)

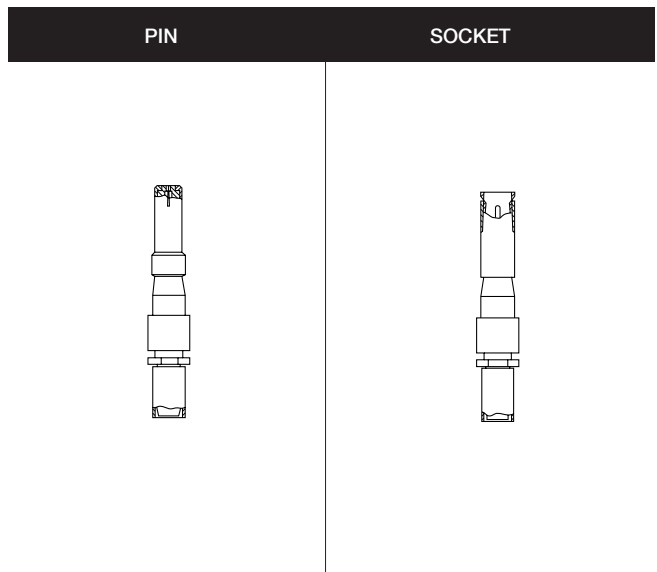
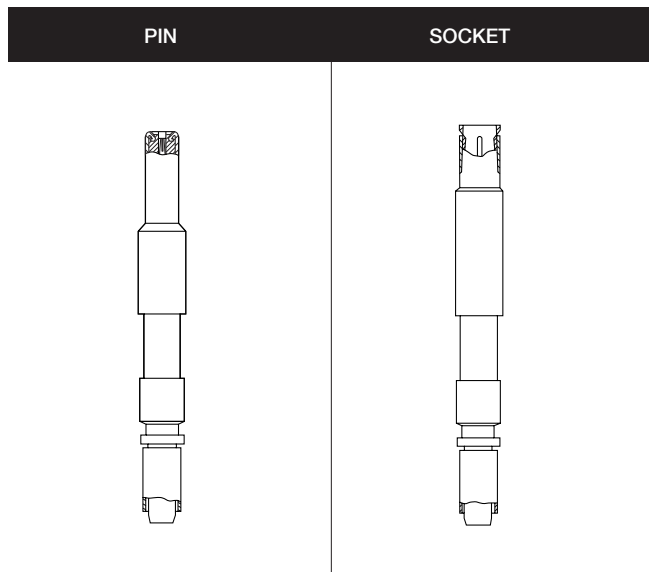

Note: Illustrations are for chart above.

Note: Illustrations are for chart on [page 135](#).

PIN & SOCKET SE CRIMP COAX CONTACTS

CABLE	INNER SOLDER CONTACT				HAND-CRIMP TOOL OUTER SHELL		CLAMP NUT WRENCH	INSERTION TOOL	EXTRACTION TOOL
	PINS		SOCKET		MIL-C22520/5-01	MIL-C22520/10-01			
	.00005 GOLD OVER SILVER	.00010 GOLD OVER COPPER	.00005 GOLD OVER SILVER	.00010 GOLD OVER COPPER	USE WITH DIE PART # (LOCATOR CAVITY)	USE WITH DIE PART # (LOCATOR CAVITY)			
CONTACT SIZE 12									
RG-161/U RG-174A/U RG-179B/U RG-187A/U RG-188A/U RG-316/U	21-033012-001 <i>21-033012-004</i>	21-033038-001 <i>21-033038-004</i>	21-033011-001 <i>21-033011-004</i>	21-033037-001 <i>21-033037-004</i>	-	M22520/10-05 (A)	11-8676-1	11-8369-2 11-8660-2	11-7880-12 11-8154-2
RG-178B/U RG-196A/U	21-033012-003* <i>21-033012-005</i>	21-033038-003* <i>21-033038-005</i>	21-033011-003* <i>21-033011-005</i>	21-033037-003* <i>21-033037-005</i>	-	M22520/10-05 (A)	11-8676-1	11-8369-1 11-8660-1	11-7880-12 11-8154-2
RG-188 or RG-316 Double Braid	21-033012-006* <i>21-033012-007</i>	21-033038-006* <i>21-033038-007</i>	21-033011-006* <i>21-033011-007</i>	21-033037-006* <i>21-033037-007</i>	M22520/5-37 (B)	-	11-8676-1	11-8369-2 11-8660-2	11-7880-12 11-8154-2
Westrex 199-49-1 Tensolite 30850/87T-1	N/A <i>21-033012-043</i>	N/A <i>21-033038-043</i>	N/A <i>21-033011-043</i>	N/A <i>21-033037-043</i>	-	M22520/10-05 (B)	11-8676-1	11-8369-1 11-8660-1	11-7880-12 11-8154-2
CONTACT SIZE 8									
RG-55B/U RG-142A/U RG-142B/U RG-223/U	21-033012-21 <i>21-033012-25</i>	21-033038-21 <i>21-033038-25</i>	21-033011-21 <i>21-033011-25</i>	21-033037-21 <i>21-033037-25</i>	-	M22520/10-07 (A)	11-8676-2	11-8369-5 11-8660-5	11-7880-8 11-8154-1
RG-58C/U RG-141A/U RG-303/U	21-033012-022 <i>21-033012-026</i>	21-033038-022* <i>21-033038-026*</i>	21-033011-022 <i>21-033011-026</i>	21-033037-022 <i>21-033037-026*</i>	-	M22520/10-07 (B)	11-8676-2	11-8369-4 11-8660-4	11-7880-8 11-8154-1
RG-59B/U RG-62A/U RG-62B/U RG-210/U	N/A <i>21-033012-036</i>	N/A <i>21-033038-036*</i>	N/A <i>21-033011-036</i>	N/A <i>21-033037-036</i>	M22520/5-45 (B)	-	11-8676-2	11-8369-5 11-8660-5	11-7880-8 11-8154-1
RG-140/U RG-302/U	N/A <i>21-033012-037*</i>	N/A <i>21-033038-037*</i>	N/A <i>21-033011-037*</i>	N/A <i>21-033037-037*</i>	-	M22520/10-07 (A)	11-8676-2	11-8369-5 11-8660-5	11-7880-8 11-8154-1
RG-161/U RG-174A/U RG-179B/U RG-187A/U RG-188A/U RG-316/U	21-033012-034 <i>21-033012-030</i>	21-033038-034 <i>21-033038-030</i>	21-033011-034 <i>21-033011-030</i>	21-033037-034 <i>21-033037-030</i>	-	M22520/10-05 (A)	11-8676-2	11-8369-2 11-8660-2	11-7880-8 11-8154-1
RG-178B/U RG-196A/U	21-033012-035 <i>N/A</i>	21-033038-035 <i>N/A</i>	21-033011-035 <i>N/A</i>	21-033037-035 <i>N/A</i>	-	M22520/10-05 (A)	11-8676-2	11-8369-1 11-8660-1	11-7880-8 11-8154-1
RG-180B/U RG-195A/U	N/A <i>21-033012-046*</i>	N/A <i>21-033038-046*</i>	21-033011-024 <i>21-033011-046*</i>	21-033037-024 <i>21-033037-046*</i>	-	M22520/10-07 (B)	11-8676-2	11-8369-4 11-8660-4	11-7880-8 11-8154-1
Thermax 50C25ADS1	N/A <i>21-033012-044</i>	N/A <i>21-033038-044*</i>	N/A <i>21-033011-044</i>	N/A <i>21-033037-044*</i>	M22520/05-37 (B)	-	11-8676-2	11-8369-5 11-8660-5	11-7880-8 11-8154-1
RG-195 Double Braid	21-033012-028 <i>N/A</i>	21-033038-028* <i>N/A</i>	21-033011-028 <i>N/A</i>	21-033037-028* <i>N/A</i>	M22520/05-43 (B)	-	11-8676-2	11-8369-4 11-8660-4	11-7880-8 11-8154-1
RG-122/U Tyco 5022E5111	21-033012-023 <i>21-033012-027</i>	21-033038-023* <i>21-033038-027</i>	21-033011-023 <i>21-033011-027</i>	21-033037-023* <i>21-033037-027</i>	-	M22520/10-07 (B)	11-8676-2	11-8369-4 11-8660-4	11-7880-8 11-8154-1
Tyco 9530D5314	21-033012-031 <i>N/A</i>	21-033038-031 <i>N/A</i>	21-033011-031 <i>N/A</i>	21-033037-031 <i>N/A</i>	-	M22520/10-07 (B)	11-8676-2	11-8369-4 11-8660-4	11-7880-8 11-8154-1
Tyco 9527A1317	N/A <i>21-033012-039</i>	N/A <i>21-033038-039*</i>	N/A <i>21-033011-039</i>	N/A <i>21-033037-039*</i>	-	M22520/10-07 (B)	11-8676-2	11-8369-4 11-8660-4	11-7880-8 11-8154-1
Tyco 7527A1318	N/A <i>21-033012-040*</i>	N/A <i>21-033038-040*</i>	N/A <i>21-033011-040</i>	N/A <i>21-033037-040*</i>	-	M22520/10-05 (A)	11-8676-2	11-8369-2 11-8660-2	11-7880-8 11-8154-1

Italicized = Matched impedance contacts. *Contact us for availability.
Availability of coax contacts varies widely. Contact us for strip lengths and assembly instructions.

COMPONENTS

PLUGS

RECEPTACLES

PT

PTSE

PT

PTSE

O-Ring



Barrel/Shell



Wave Spring



Coupling Nut



Insert/Insulator



Contacts



Wire Sealing Grommet



Ferrule/
Compression Ring



Endbell/
Cable Clamp



PRINTED CIRCUIT BOARD

BOX MOUNT
PT02

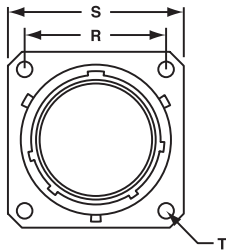

PT02PCB

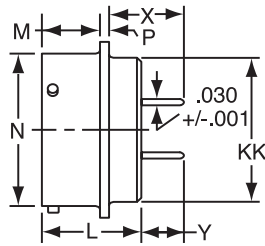

JAM NUT
PT07

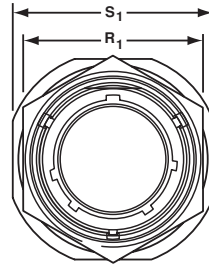

PT07PCB

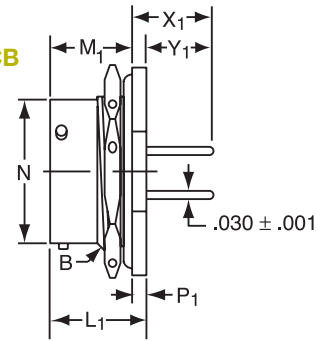

BOX MOUNT

SHELL SIZE	PART NUMBER PT02 WITH PCB CONTACTS	M	N +.001 -.055	P	R	S	T	L MAX.	KK DIA. MAX.	Y +.040 -.050	X +.040 -.050
6	71-570120*	0.431 (10.9)	0.348 (8.8)	0.062 (1.6)	0.469 (11.9)	0.688 (17.5)	0.120 (3.0)	0.774 (19.7)	0.323 (8.2)	0.380 (9.7)	0.661 (16.8)
8	71-570121*	0.431 (10.9)	0.473 (12.0)	0.062 (1.6)	0.594 (15.1)	0.812 (20.6)	0.120 (3.0)	0.774 (19.7)	0.449 (11.4)	0.380 (9.7)	0.661 (16.8)
10	71-570122*	0.431 (10.9)	0.590 (15.0)	0.062 (1.6)	0.719 (18.3)	0.938 (23.8)	0.120 (3.0)	0.774 (19.7)	0.573 (14.6)	0.380 (9.7)	0.661 (16.8)
12	71-570123*	0.431 (10.9)	0.750 (19.1)	0.062 (1.6)	0.812 (20.6)	1.031 (26.2)	0.120 (3.0)	0.774 (19.7)	0.699 (17.8)	0.380 (9.7)	0.661 (16.8)
14	71-570124*	0.431 (10.9)	0.875 (22.2)	0.062 (1.6)	0.906 (23.0)	1.125 (28.6)	0.120 (3.0)	0.774 (19.7)	0.823 (20.9)	0.380 (9.7)	0.661 (16.8)
16	71-570125*	0.431 (10.9)	1.000 (25.4)	0.062 (1.6)	0.969 (24.6)	1.219 (31.0)	0.120 (3.0)	0.774 (19.7)	0.949 (24.1)	0.380 (9.7)	0.661 (16.8)
18	71-570126*	0.431 (10.9)	1.125 (28.6)	0.062 (1.6)	1.062 (27.0)	1.312 (33.3)	0.120 (3.0)	0.774 (19.7)	1.073 (27.3)	0.380 (9.7)	0.661 (16.8)
20	71-570127*	0.556 (14.1)	1.250 (31.8)	0.094 (2.4)	1.156 (29.4)	1.438 (36.5)	0.120 (3.0)	1.025 (26.0)	1.199 (30.5)	0.286 (7.3)	0.661 (16.8)
22	71-570128*	0.556 (14.1)	1.375 (34.9)	0.094 (2.4)	1.250 (31.8)	1.561 (39.6)	0.120 (3.0)	1.025 (26.0)	1.323 (33.6)	0.286 (7.3)	0.661 (16.8)
24	71-570129*	0.589 (14.9)	1.500 (38.1)	0.094 (2.4)	1.375 (34.9)	1.688 (42.9)	0.147 (3.7)	1.058 (26.9)	1.449 (36.8)	0.253 (6.4)	0.628 (16.0)

JAM NUT

SHELL SIZE	PART NUMBER PT07 WITH PCB CONTACTS	B THREAD CLASS 2A UNEF	M1	N +.001 -.055	P1	R1	S1	PANEL THICKNESS		L1	Y1	X1
								MIN.	MAX.			
6	71-533720*	0.4375-28	0.696 (17.7)	0.348 (8.8)	0.125 (3.2)	0.625 (15.9)	0.812 (20.6)	0.062 (1.6)	0.125 (3.2)	0.821 (20.9)	0.376 (9.6)	0.501 (12.7)
8	71-533721*	0.5625-24	0.696 (17.7)	0.473 (12.0)	0.125 (3.2)	0.750 (19.1)	0.938 (23.8)	0.062 (1.6)	0.125 (3.2)	0.821 (20.9)	0.376 (9.6)	0.501 (12.7)
10	71-533722*	0.6875-24	0.696 (17.7)	0.590 (15.0)	0.125 (3.2)	0.875 (22.2)	1.062 (27.0)	0.062 (1.6)	0.125 (3.2)	0.821 (20.9)	0.376 (9.6)	0.501 (12.7)
12	71-533723*	0.8750-20	0.696 (17.7)	0.750 (19.1)	0.125 (3.2)	1.062 (27.0)	1.250 (31.8)	0.062 (1.6)	0.125 (3.2)	0.821 (20.9)	0.376 (9.6)	0.501 (12.7)
14	71-533724*	1.0000-20	0.696 (17.7)	0.875 (22.2)	0.125 (3.2)	1.188 (30.2)	1.375 (34.9)	0.062 (1.6)	0.125 (3.2)	0.821 (20.9)	0.376 (9.6)	0.501 (12.7)
16	71-533725*	1.1250-18	0.696 (17.7)	1.000 (25.4)	0.125 (3.2)	1.312 (33.3)	1.500 (38.1)	0.062 (1.6)	0.125 (3.2)	0.821 (20.9)	0.376 (9.6)	0.501 (12.7)
18	71-533726*	1.2500-18	0.696 (17.7)	1.125 (28.6)	0.125 (3.2)	1.438 (36.5)	1.625 (41.3)	0.062 (1.6)	0.125 (3.2)	0.821 (20.9)	0.376 (9.6)	0.501 (12.7)
20	71-533727*	1.3750-18	0.884 (22.5)	1.250 (31.8)	0.156 (4.0)	1.562 (39.7)	1.812 (46.0)	0.062 (1.6)	0.250 (6.4)	1.040 (26.4)	0.367 (9.3)	0.523 (13.3)
22	71-533728*	1.5000-18	0.884 (22.5)	1.375 (34.9)	0.156 (4.0)	1.688 (42.9)	1.938 (49.2)	0.062 (1.6)	0.250 (6.4)	1.040 (26.4)	0.367 (9.3)	0.523 (13.3)
24	71-533729*	1.6250-18	0.917 (23.3)	1.500 (38.1)	0.156 (4.0)	1.812 (46.1)	2.062 (52.4)	0.062 (1.6)	0.250 (6.4)	1.073 (27.2)	0.334 (8.5)	0.490 (12.4)

Part number prefix codes:
 58 = Conductive Black Alloy (027) RoHS
 71 = Olive Drab Chromate over Cadmium (typical)
 72 = Anodic Coating (005)

91 = Electroless Nickel (023) RoHS
 93 = Non-Conductive Black Alloy (025) RoHS
 FL = Grey Zinc Nickel (072) RoHS

*See [page 127, 129](#) for insert arrangement (layout) codes.

DIMENSIONS

RECEPTACLE STYLES

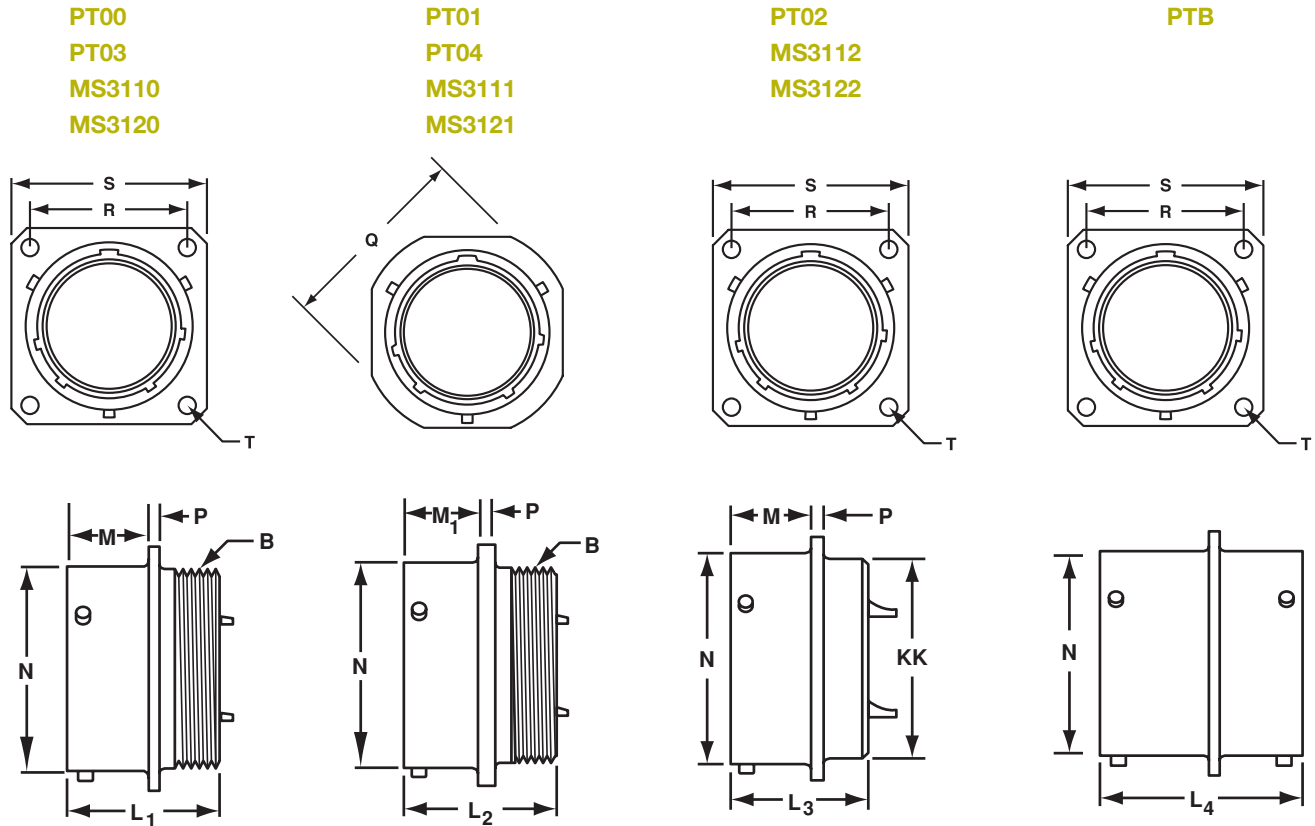

SHELL SIZE	PT00/PT02/PTB			PT01			PT00/PT02/PTB			PT00	PT02		PTB	PT00/PT01	
	M +0.010 -0.000	N +0.001 -0.005	MS31_0 MS31_2 P	MS31_1 P	M1 MAX.	Q.	R	S	T	L1 MAX.	L3 MAX.	KK DIA. MAX.	L4 MAX.	L2 MAX.	B THREAD CLASS 2A
6	0.431 (10.9)	0.348 (8.8)	0.062 (1.6)	0.093 (2.4)	0.400 (10.1)	0.812 (20.6)	0.469 (11.9)	0.688 (17.5)	0.120 (3.0)	0.906 (23.0)	0.825 (21.0)	0.323 (8.2)	1.050 (26.7)	0.906 (23.0)	.3125-32 NEF
8	0.431 (10.9)	0.473 (12.0)	0.062 (1.6)	0.093 (2.4)	0.400 (10.1)	0.938 (23.8)	0.594 (15.1)	0.812 (20.6)	0.120 (3.0)	0.906 (23.0)	0.825 (21.0)	0.449 (11.4)	1.050 (26.7)	0.906 (23.0)	.4375-28 UNEF
10	0.431 (10.9)	0.590 (15.0)	0.062 (1.6)	0.093 (2.4)	0.400 (10.1)	1.062 (27.0)	0.719 (18.3)	0.938 (23.8)	0.120 (3.0)	0.906 (23.0)	0.825 (21.0)	0.573 (14.6)	1.050 (26.7)	0.906 (23.0)	.5625-24 NEF
12	0.431 (10.9)	0.750 (19.1)	0.062 (1.6)	0.093 (2.4)	0.400 (10.1)	1.156 (29.4)	0.812 (20.6)	1.031 (26.2)	0.120 (3.0)	0.906 (23.0)	0.825 (21.0)	0.699 (17.8)	1.050 (26.7)	0.906 (23.0)	.6875-24 NEF
14	0.431 (10.9)	0.875 (22.2)	0.062 (1.6)	0.093 (2.4)	0.400 (10.1)	1.250 (31.8)	0.906 (23.0)	1.125 (28.6)	0.120 (3.0)	0.906 (23.0)	0.825 (21.0)	0.823 (20.9)	1.050 (26.7)	0.906 (23.0)	.8125-20 UNEF
16	0.431 (10.9)	1.000 (25.4)	0.062 (1.6)	0.093 (2.4)	0.400 (10.1)	1.344 (34.1)	0.969 (24.6)	1.219 (31.0)	0.120 (3.0)	0.906 (23.0)	0.825 (21.0)	0.949 (24.1)	1.050 (26.7)	0.906 (23.0)	.9375-20 UNEF
18	0.431 (10.9)	1.125 (28.6)	0.062 (1.6)	0.093 (2.4)	0.400 (10.1)	1.438 (36.5)	1.062 (27.0)	1.312 (33.3)	0.120 (3.0)	0.906 (23.0)	0.825 (21.0)	1.073 (27.3)	1.050 (26.7)	0.906 (23.0)	1.0625-18 NEF
20	0.556 (14.1)	1.250 (31.8)	0.094 (2.4)	0.115 (2.9)	0.535 (13.6)	1.562 (39.7)	1.156 (29.4)	1.438 (36.5)	0.120 (3.0)	1.125 (28.6)	1.076 (27.3)	1.199 (30.5)	1.330 (33.8)	1.125 (28.6)	1.1875-18 NEF
22	0.556 (14.1)	1.375 (34.9)	0.094 (2.4)	0.115 (2.9)	0.535 (13.6)	1.688 (42.9)	1.250 (31.8)	1.562 (39.6)	0.120 (3.0)	1.125 (28.6)	1.076 (27.3)	1.323 (33.6)	1.330 (33.8)	1.125 (28.6)	1.3125-18 NEF
24	0.589 (14.9)	1.500 (38.1)	0.094 (2.4)	0.115 (2.9)	0.568 (14.4)	1.812 (46.0)	1.375 (34.9)	1.688 (42.9)	0.147 (3.7)	1.188 (30.2)	1.109 (28.2)	1.449 (36.8)	1.330 (33.8)	1.188 (30.2)	1.4375-18 NEF

All dimensions in inches (millimeters in parenthesis)

ENDBELL STYLES

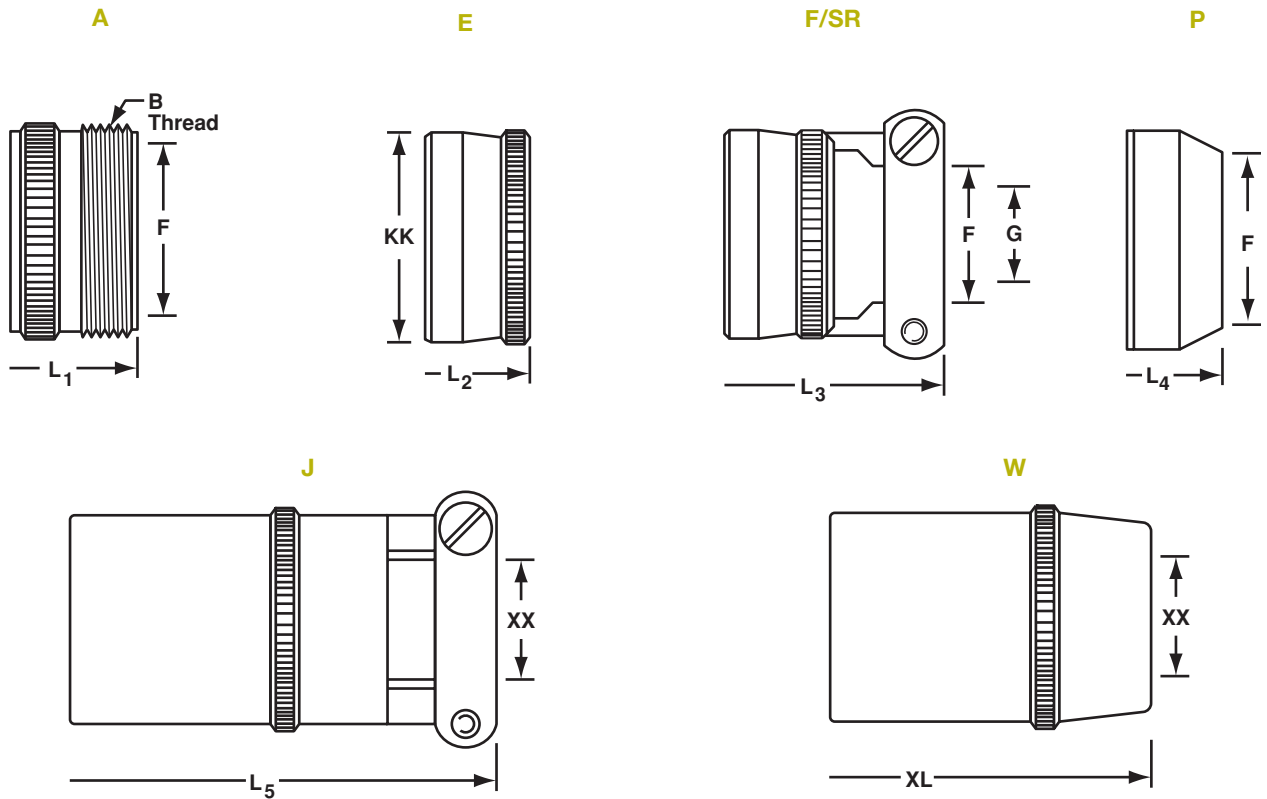

SHELL SIZE	A ENDBELL			E ENDBELL		F/SR ENDBELL			P ENDBELL		W	J	W/J ENDBELL	
	F MAX.	L1	B THREAD CLASS 2A	L2	KK MAX.	F	G	L3 MAX.	F	L4 MAX.	XL	L5 MAX.	XX MIN.	XX MAX.
6	0.175	1.553	.3750-32	1.266	0.440	-	-	-	0.192	1.438	-	-	-	-
	(4.4)	(39.4)	NEF	(32.2)	(11.2)	-	-	-	(4.9)	(36.5)	-	-	-	-
8	0.297	1.553	.5000-28	1.266	0.560	0.240	0.125	1.922	0.317	1.438	1.705	2.271	0.168	0.230
	(7.5)	(39.4)	UNEF	(32.2)	(14.2)	(6.1)	(3.2)	(48.8)	(8.1)	(36.5)	(43.3)	(57.7)	(4.3)	(5.8)
10	0.421	1.553	.6250-24	1.266	0.685	0.302	0.188	1.922	0.434	1.438	1.705	2.271	0.205	0.312
	(10.7)	(39.4)	NEF	(32.2)	(17.3)	(7.7)	(4.8)	(48.8)	(11.0)	(36.5)	(43.3)	(57.7)	(5.2)	(7.9)
12	0.546	1.553	.7500-20	1.266	0.813	0.428	0.312	1.922	0.548	1.438	1.848	2.411	0.338	0.442
	(13.9)	(39.4)	UNEF	(32.2)	(20.7)	(10.9)	(7.9)	(48.8)	(13.9)	(36.5)	(46.9)	(61.2)	(8.6)	(11.2)
14	0.663	1.553	.8750-20	1.266	0.930	0.552	0.375	1.922	0.673	1.438	2.040	2.599	0.416	0.539
	(16.8)	(39.4)	UNEF	(32.2)	(23.6)	(14.0)	(9.5)	(48.8)	(17.1)	(36.5)	(51.8)	(66.0)	(10.6)	(13.7)
16	0.787	1.553	1.0000-20	1.266	1.057	0.615	0.500	2.047	0.798	1.438	2.256	2.943	0.550	0.616
	(20.0)	(39.4)	UNEF	(32.2)	(26.8)	(15.6)	(12.7)	(52.0)	(20.3)	(36.5)	(57.3)	(74.8)	(14.0)	(15.6)
18	0.879	1.553	1.1875-18	1.266	1.175	0.740	0.625	2.078	0.899	1.438	2.486	3.172	0.600	0.672
	(22.3)	(39.4)	NEF	(32.2)	(29.8)	(18.8)	(15.9)	(52.8)	(22.8)	(36.5)	(63.1)	(80.6)	(15.2)	(17.1)
20	1.041	1.703	1.1875-18	1.516	1.301	0.740	0.625	2.344	1.024	1.656	2.922	3.610	0.635	0.747
	(26.4)	(43.3)	NEF	(38.5)	(33.0)	(18.8)	(15.9)	(59.5)	(26.0)	(42.1)	(74.2)	(91.7)	(16.1)	(19.0)
22	1.135	1.703	1.4375-18	1.516	1.430	0.928	0.750	2.344	1.149	1.656	3.086	3.766	0.670	0.846
	(28.8)	(43.3)	NEF	(38.5)	(36.3)	(23.6)	(19.1)	(59.5)	(29.2)	(42.1)	(78.4)	(95.7)	(17.0)	(21.5)
24	1.259	1.765	1.4375-18	1.578	1.555	0.990	0.800	2.406	1.274	1.717	3.310	3.985	0.740	0.894
	(32.0)	(44.8)	NEF	(40.1)	(39.5)	(25.1)	(20.3)	(61.1)	(32.4)	(43.6)	(84.1)	(101.2)	(18.8)	(22.7)

All dimensions in inches (millimeters in parenthesis)

DIMENSIONS

STRAIGHT PLUGS

PT06
PT05
MS3116
MS3126

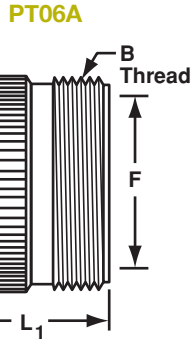
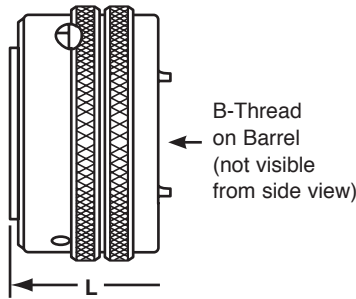
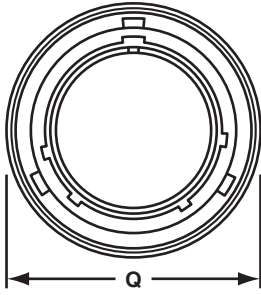

PT06E
MS3116E
MS3126E

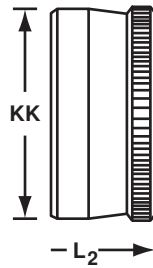

PT06E-SR
PT06SE-SR
PT06CE-SR
MS3116F
MS3126F

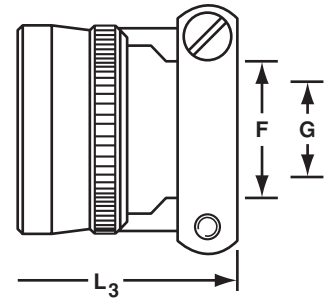

SHELL SIZE	PT06			PT06A			PT06E		PTSE06E	PT06E/SR			PTSE06/SR
	Q	L MAX.	B THREAD CLASS 2A	F	L ¹ MAX.	B THREAD CLASS 2A	L ² MAX.	KK	L ² MAX.	F	G	L ³ MAX.	L ³ MAX.
6	0.625 (15.9)	0.906 (23.0)	.3125-32 NEF	0.175 (4.4)	1.553 (39.4)	.3750-32 NEF	1.266 (32.2)	0.440 (11.2)	-	-	-	-	-
8	0.750 (19.1)	0.906 (23.0)	.4375-28 UNEF	0.297 (7.5)	1.553 (39.4)	.5000-28 UNEF	1.266 (32.2)	0.560 (14.2)	1.328 (33.7)	0.240 (6.1)	0.125 (3.2)	1.906 (48.4)	2.413 (61.3)
10	0.859 (21.8)	0.906 (23.0)	.5625-24 NEF	0.421 (10.7)	1.553 (39.4)	.6250-24 NEF	1.266 (32.2)	0.685 (17.3)	1.328 (33.7)	0.302 (7.7)	0.188 (4.8)	1.906 (48.4)	2.413 (61.3)
12	1.013 (25.7)	0.906 (23.0)	.6875-24 NEF	0.546 (13.9)	1.553 (39.4)	.7500-20 UNEF	1.266 (32.2)	0.813 (20.7)	1.328 (33.7)	0.428 (10.9)	0.312 (7.9)	1.906 (48.4)	2.413 (61.3)
14	1.156 (29.4)	0.906 (23.0)	.8125-20 UNEF	0.663 (16.8)	1.553 (39.4)	.8750-20 UNEF	1.266 (32.2)	0.930 (23.6)	1.328 (33.7)	0.552 (14.0)	0.375 (9.5)	1.906 (48.4)	2.413 (61.3)
16	1.281 (32.5)	0.906 (23.0)	.9375-20 UNEF	0.787 (20.0)	1.553 (39.4)	1.0000-20 UNEF	1.266 (32.2)	1.057 (26.8)	1.328 (33.7)	0.615 (15.6)	0.500 (12.7)	2.047 (52.0)	2.528 (64.2)
18	1.319 (33.5)	0.906 (23.0)	1.0625-18 NEF	0.879 (22.3)	1.553 (39.4)	1.1875-18 NEF	1.266 (32.2)	1.175 (29.8)	1.328 (33.7)	0.740 (18.8)	0.625 (15.9)	2.078 (52.8)	2.528 (64.2)
20	1.531 (38.9)	1.062 (27.0)	1.1875-18 NEF	1.014 (25.8)	1.703 (43.3)	1.1875-18 NEF	1.438 (36.5)	1.301 (33.0)	1.297 (32.9)	0.740 (18.8)	0.625 (15.9)	2.250 (57.2)	2.753 (70.0)
22	1.656 (42.1)	1.062 (27.0)	1.3125-18 NEF	1.135 (28.8)	1.703 (43.3)	1.4375-18 NEF	1.438 (36.5)	1.430 (36.3)	1.297 (32.9)	0.928 (23.6)	0.750 (19.1)	2.250 (57.2)	2.753 (70.0)
24*	1.776 (45.1)	1.125 (28.6)	1.4375-18 NEF	1.259 (32.0)	1.765 (44.8)	1.4375-18 NEF	1.500 (38.1)	1.555 (39.5)	1.359 (34.5)	0.990 (25.1)	0.800 (20.3)	2.312 (58.7)	2.830 (71.9)

* Commercial

All dimensions in inches (millimeters in parenthesis)

STRAIGHT PLUGS

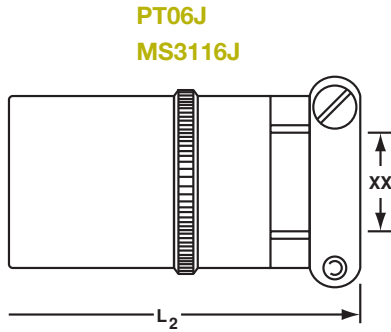

PT06P
PT06SP
PT06CP
MS3116P
MS3126P

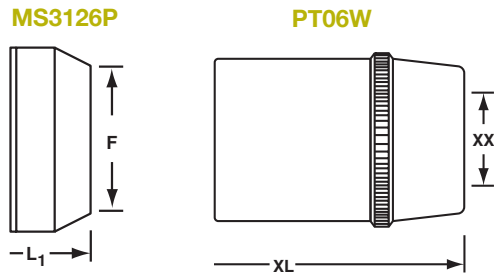

RIGHT ANGLE PLUGS

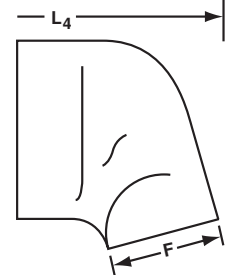
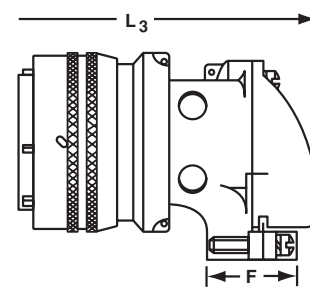
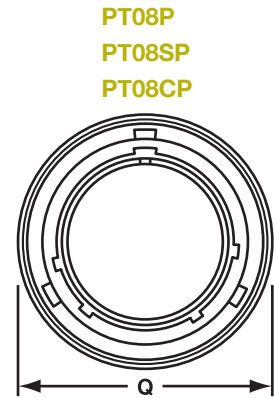
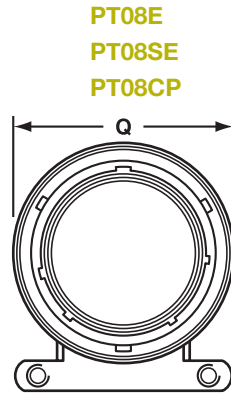

SHELL SIZE	PT06P		PT06W	PT06J	PT06W/J		PT08E			PTSE08E	PT08P		PTSE08P
	F DIA.	L ¹ MAX.	XL	L ² MAX.	XX MIN.	XX MAX.	Q	F ¹	L ³ MAX.	L ³ MAX.	F ²	L ⁴ MAX.	L ⁴ MAX.
6	0.192 (4.9)	1.526 (38.8)	-	-	-	-	-	-	-	-	-	-	-
8	0.317 (8.1)	1.526 (38.8)	1.705 (43.3)	2.271 (57.7)	0.168 (4.3)	0.230 (5.8)	0.796 (20.2)	0.169 (4.3)	1.786 (45.4)	-	0.312 (7.9)	1.656 (42.1)	-
10	0.434 (11.0)	1.526 (38.8)	1.705 (43.3)	2.271 (57.7)	0.205 (5.2)	0.312 (7.9)	0.921 (23.4)	0.170 (4.3)	1.880 (47.8)	2.137 (54.3)	0.438 (11.1)	1.781 (45.2)	2.031 (51.6)
12	0.548 (13.9)	1.526 (38.8)	1.848 (46.9)	2.411 (61.2)	0.338 (8.6)	0.442 (11.2)	1.046 (26.6)	0.264 (6.7)	1.965 (49.9)	2.222 (56.4)	0.516 (13.1)	1.743 (44.3)	2.093 (53.2)
14	0.673 (17.1)	1.526 (38.8)	2.040 (51.8)	2.599 (66.0)	0.416 (10.6)	0.539 (13.7)	1.171 (29.7)	0.310 (7.9)	2.113 (53.7)	2.370 (60.2)	0.625 (15.9)	1.953 (49.6)	2.203 (56.0)
16	0.798 (20.3)	1.526 (38.8)	2.256 (57.3)	2.943 (74.8)	0.550 (14.0)	0.616 (15.6)	1.297 (32.9)	0.330 (8.4)	2.315 (58.8)	2.572 (65.3)	0.656 (16.7)	2.000 (50.8)	2.250 (57.2)
18	0.899 (22.8)	1.526 (38.8)	2.486 (63.1)	3.172 (80.6)	0.600 (15.2)	0.672 (17.1)	1.422 (36.1)	0.444 (11.3)	2.423 (61.5)	2.680 (68.1)	0.703 (17.9)	2.046 (52.0)	2.296 (58.3)
20	1.024 (26.0)	1.546 (39.3)	2.844 (72.2)	3.610 (91.7)	0.635 (16.1)	0.747 (19.0)	1.562 (39.7)	0.510 (13.0)	2.695 (68.5)	2.753 (68.9)	0.766 (19.5)	2.218 (56.3)	2.343 (59.5)
22	1.149 (29.2)	1.546 (39.3)	3.000 (76.2)	3.766 (95.7)	0.670 (17.0)	0.846 (21.5)	1.672 (42.5)	0.515 (13.1)	2.742 (69.6)	2.799 (71.1)	0.812 (20.6)	2.265 (57.5)	2.390 (60.7)
24	1.274 (32.4)	1.656 (42.1)	3.210 (81.5)	3.985 (101.2)	0.740 (18.8)	0.894 (22.7)	1.797 (45.6)	0.656 (16.7)	2.980 (75.7)	3.037 (77.1)	0.918 (23.3)	2.624 (66.6)	2.624 (66.6)

All dimensions in inches (millimeters in parenthesis)

DIMENSIONS

JAM NUT RECEPTACLES

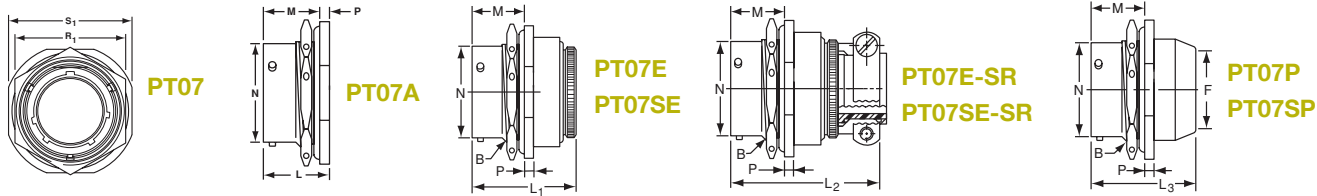

SHELL SIZE	B THREAD UNEF-2A	PT07							L	PT07A		PT07E-SR		PT07SE-SR		PT07P		L3 MAX.
		M	N	P	R	S	MIN.	MAX.		L1 MAX.	L2 MAX.	L1 MAX.	L2 MAX.	F	L3 MAX.			
		(mm)	(mm)	(mm)	(mm)	(mm)				(mm)	(mm)	(mm)	(mm)	(mm)	(mm)	(mm)		
6	.4375-28	0.696 (17.7)	0.348 (8.8)	0.125 (3.2)	0.625 (15.9)	0.812 (20.6)	0.062 (1.6)	0.125 (3.2)	0.821 (20.9)	1.282 (32.6)	-	-	-	-	0.202 (5.1)	1.289 (32.7)	-	
8	.5625-24	0.696 (17.7)	0.473 (12.0)	0.125 (3.2)	0.750 (19.1)	0.938 (23.8)	0.062 (1.6)	0.125 (3.2)	0.821 (20.9)	1.282 (32.6)	1.758 (44.7)	1.438 (36.5)	1.922 (48.8)	0.327 (8.3)	1.289 (32.7)	-		
10	.6875-24	0.696 (17.7)	0.590 (15.0)	0.125 (3.2)	0.875 (22.2)	1.062 (27.0)	0.062 (1.6)	0.125 (3.2)	0.821 (20.9)	1.282 (32.6)	1.758 (44.7)	1.438 (36.5)	1.922 (48.8)	0.444 (11.3)	1.289 (32.7)	1.656 (42.1)		
12	.8750-20	0.696 (17.7)	0.750 (19.1)	0.125 (3.2)	1.062 (27.0)	1.250 (31.8)	0.062 (1.6)	0.125 (3.2)	0.821 (20.9)	1.282 (32.6)	1.758 (44.7)	1.438 (36.5)	1.922 (48.8)	0.558 (14.2)	1.289 (32.7)	1.656 (42.1)		
14	1.0000-20	0.696 (17.7)	0.875 (22.2)	0.125 (3.2)	1.188 (30.2)	1.375 (34.9)	0.062 (1.6)	0.125 (3.2)	0.821 (20.9)	1.282 (32.6)	1.758 (44.7)	1.438 (36.5)	1.922 (48.8)	0.683 (17.3)	1.289 (32.7)	1.656 (42.1)		
16	1.1250-18	0.696 (17.7)	1.000 (25.4)	0.125 (3.2)	1.312 (33.3)	1.500 (38.1)	0.062 (1.6)	0.125 (3.2)	0.821 (20.9)	1.282 (32.6)	1.884 (47.9)	1.438 (36.5)	2.000 (50.8)	0.808 (20.5)	1.289 (32.7)	1.656 (42.1)		
18	1.2500-18	0.696 (17.7)	1.125 (28.6)	0.125 (3.2)	1.438 (36.5)	1.625 (41.3)	0.062 (1.6)	0.125 (3.2)	0.821 (20.9)	1.282 (32.6)	1.884 (47.9)	1.438 (36.5)	2.000 (50.8)	0.909 (23.1)	1.289 (32.7)	1.656 (42.1)		
20	1.3750-18	0.884 (22.5)	1.250 (31.8)	0.156 (4.0)	1.562 (39.7)	1.812 (46.0)	0.062 (1.6)	0.250 (6.4)	1.040 (26.4)	1.514 (38.5)	2.134 (54.2)	1.625 (41.4)	2.172 (55.2)	1.034 (26.3)	1.602 (40.7)	1.922 (48.8)		
22	1.5000-18	0.884 (22.5)	1.375 (34.9)	0.156 (4.0)	1.688 (42.9)	1.938 (49.2)	0.062 (1.6)	0.250 (6.4)	1.040 (26.4)	1.514 (38.5)	2.134 (54.2)	1.625 (41.4)	2.172 (55.2)	1.159 (29.4)	1.602 (40.7)	1.922 (48.8)		
24	1.6250-18	0.917 (23.3)	1.500 (38.1)	0.156 (4.0)	1.816 (46.1)	2.062 (52.4)	0.062 (1.6)	0.250 (6.4)	1.073 (27.2)	1.547 (39.3)	2.167 (55.0)	1.688 (48.8)	2.234 (56.7)	1.284 (32.6)	1.635 (41.5)	1.951 (49.6)		

PANEL CUTOUTS/THICKNESS

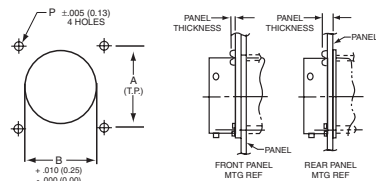

PT00/PT02/PTB

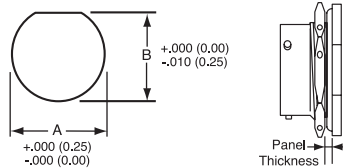

PT07

SHELL SIZE	B FRONT MOUNT	A	P ±.005 (±.125)	SCREW SIZE	PANEL THICKNESS		SHELL SIZE	A +.010-.000 (+.25-.00)	B +.000-.010 (+.00-.25)	PANEL THICKNESS	
					B PT00/PT02	B PTB				MIN.	MAX.
6	0.492 (12.5)	0.469 (11.9)	0.125 (3.2)	#4	0.087 (2.2)	0.218 (5.5)	6	0.447 (11.4)	0.420 (10.7)	0.062 (1.6)	0.125 (3.2)
8	0.618 (15.7)	0.594 (15.1)	0.125 (3.2)	#4	0.087 (2.2)	0.218 (5.5)	8	0.572 (14.5)	0.542 (13.8)	0.062 (1.6)	0.125 (3.2)
10	0.735 (18.7)	0.719 (18.3)	0.125 (3.2)	#4	0.087 (2.2)	0.218 (5.5)	10	0.697 (17.7)	0.669 (17.0)	0.062 (1.6)	0.125 (3.2)
12	0.859 (21.8)	0.812 (20.6)	0.125 (3.2)	#4	0.087 (2.2)	0.218 (5.5)	12	0.884 (22.5)	0.830 (21.1)	0.062 (1.6)	0.125 (3.2)
14	0.985 (25)	0.906 (23.0)	0.125 (3.2)	#4	0.087 (2.2)	0.218 (5.5)	14	1.007 (25.6)	0.955 (24.3)	0.062 (1.6)	0.125 (3.2)
16	1.113 (28.3)	0.969 (24.6)	0.125 (3.2)	#4	0.087 (2.2)	0.218 (5.5)	16	1.134 (28.8)	1.084 (27.5)	0.062 (1.6)	0.125 (3.2)
18	1.235 (31.4)	1.062 (27.0)	0.125 (3.2)	#4	0.087 (2.2)	0.218 (5.5)	18	1.259 (32.0)	1.208 (30.7)	0.062 (1.6)	0.125 (3.2)
20	1.361 (34.6)	1.156 (29.4)	0.125 (3.2)	#4	0.212 (5.4)	0.344 (8.7)	20	1.384 (35.2)	1.333 (33.9)	0.062 (1.6)	0.250 (6.4)
22	1.485 (37.7)	1.250 (31.8)	0.125 (3.2)	#4	0.212 (5.4)	0.344 (8.7)	22	1.507 (38.3)	1.459 (37.1)	0.062 (1.6)	0.250 (6.4)
24	1.611 (40.9)	1.375 (34.9)	0.155 (3.9)	#6	0.212 (5.4)	0.311 (7.9)	24	1.634 (41.5)	1.575 (40.0)	0.062 (1.6)	0.250 (6.4)

MS3057-C WATERPROOF CABLE CLAMP

FLANGE MOUNT RECEPTACLE ACCESSORIES

GASKET

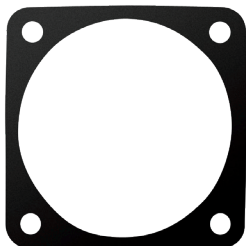

NUT PLATE

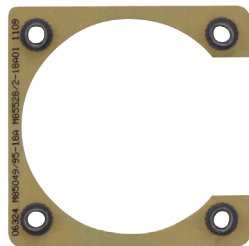

SEALING SCREWS



DUMMY RECEPTACLE

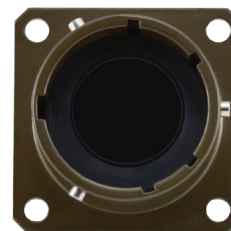

DUST CAPS

PLUG DUST CAP



RECEPTACLE FLANGE DUST CAP



RECEPTACLE JAM NUT DUST CAP



CABLE CLAMP



FLANGE MOUNT RECEPTACLE ACCESSORIES

DUST CAPS

SHELL SIZE	FLANGE MOUNT RECEPTACLE ACCESSORIES				DUST CAPS			
	GASKET	NUT PLATE	SEALING SCREWS	DUMMY RECEPTACLE	PLUGS	RECEPTACLES		CABLE CLAMP FOR A ENDBELLS
						FLANGED	JAM NUT	
8	10-101949-008 CMD02-8	M85049/95-8A	S440-1/2	MS3115-8	MS3180-8C*	MS3181-8C*	MS3181-8N*	MS3057-3A
10	10-101949-010 CMD02-10	M85049/95-10A	S440-1/2	MS3115-10	MS3180-10C*	MS3181-10C*	MS3181-10N*	MS3057-4A
12	10-101949-012 CMD02-12	M85049/95-12A	S440-1/2	MS3115-12	MS3180-12C*	MS3181-12C*	MS3181-12N*	MS3057-6A
14	10-101949-014 CMD02-14	M85049/95-14A	S440-1/2	MS3115-14	MS3180-14C*	MS3181-14C*	MS3181-14N*	MS3057-8A
16	10-101949-016 CMD02-16	M85049/95-16A	S440-1/2	MS3115-16	MS3180-16C*	MS3181-16C*	MS3181-16N*	MS3057-10A
18	10-101949-018 CMD02-18	M85049/95-18A	S440-1/2	MS3115-18	MS3180-18C*	MS3181-18C*	MS3181-18N*	MS3057-12A
20	10-101949-020 CMD02-20	M85049/95-20A	S440-1/2	MS3115-20	MS3180-20C*	MS3181-20C*	MS3181-20N*	MS3057-12A
22	10-101949-022 CMD02-22	M85049/95-22A	S440-1/2	MS3115-22	MS3180-22C*	MS3181-22C*	MS3181-22N*	MS3057-16A
24	10-101949-024 CMD02-24	M85049/95-24B	S632-1/2	MS3115-24	MS3180-24C*	MS3181-24C*	MS3181-24N*	MS3057-16A

*A = Anodized plating (omit A for olive drab)

All dimensions in inches (millimeters in parenthesis)

PT SOLDER CONTACTS

- STEP 1:** Slide the rear accessories over the wire bundle in the proper sequence for re-assembly: cable clamp and/or endbell first, then ferrule and, if used, coupling nut.
- STEP 2:** Insert individual wires through the proper holes in the grommet. Use isopropyl alcohol as a lubricant.
- STEP 3:** Solder wires to appropriate contacts on the rear of the connector. Information on standard soldering practices is available upon request. Please contact us.
- STEP 4:** Fixture the connector for reassembly using the endbell assembly tools on [page 146](#) or a mating connector with contacts installed.
- STEP 5:** Slide the grommet down the wires (lubricating the grommet with isopropyl alcohol will help).
- STEP 6:** Fill all unused grommet cavities with a wire hole filler to maintain the sealing integrity of the connector.
- STEP 7:** Slide coupling nut, ferrule, and endbell accessories over rear of the connector and tighten. For more information, [see page 146](#).

PTSE & PTCE CRIMP TOOL OPERATION

CONTACT SIZE	STRIP LENGTH
20	.275 (7.0)
16	.250 (6.4)
12	.250 (6.4)

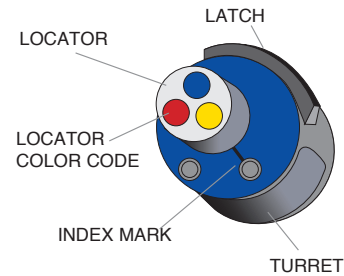
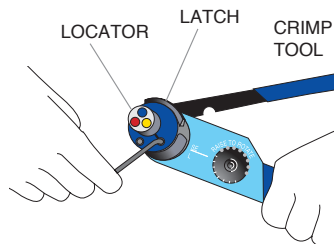

STEP 1: Strip the wires to the appropriate length.

STEP 2: Open the AF8 (M22520/1-01) crimp tool by squeezing the handles. Push the latch on TH1A (M22520/1-02) to pop up the locator on the turret. Attach the turret to the AF8 crimp tool using the two captive hex bolts in the turret.

STEP 3: Select the proper locator position for your contact by rotating the locator until the proper color is aligned with the index mark. Push locator back down until it snaps into position

CONTACT SIZE	LOCATOR COLOR
20	Red
16	Blue
12	Yellow

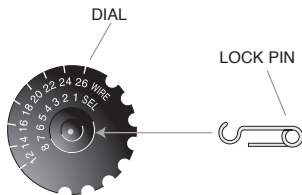

STEP 4: Adjust dial for proper wire gauge. To change the dial setting, remove the lock pin and lift center of dial. Turn to the desired wire gauge. Replace lock pin on dial.

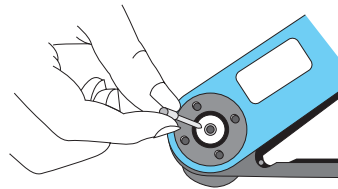

STEP 5: Cycle the tool before inserting the contact to be sure the tool is in the open position. Drop the contact, mating end first, into the crimp cavity of the tool. Squeeze the tool handle just enough to grip the contact without actually crimping it.

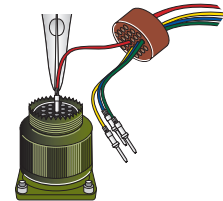

STEP 6: Insert the stripped wire into the contact with a slight twisting motion. Be sure all wire strands are inside the contact. Squeeze the handle to cycle the tool. The handle will not release until the contact is completely crimped.

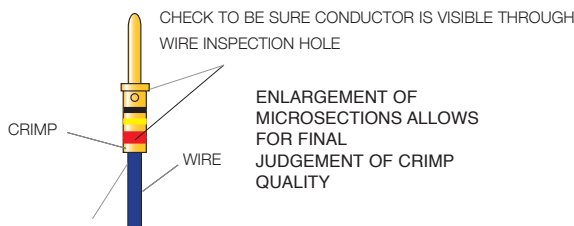

INSULATION SHOULD PRESS AGAINST THE END OF THE CONTACT.

STEP 7: Remove the crimped contact. Pull on the wire slightly to be sure it is properly crimped. Be sure the contact is not bent or damaged in any way. Visually inspect the crimp.

All dimensions in inches (millimeters in parenthesis)

INSERTION OF CONTACTS

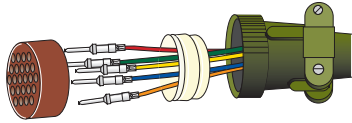

STEP 1: Slide the rear accessories over the wire bundle in the proper sequence for re-assembly: cable clamp and/or endbell first, then ferrule, and coupling nut.



STEP 2: Use the proper insertion tool from the Contact Selection Chart on [page 132](#), slide the tool over the wire side of the contact until the tool bottoms on the contact. The tool for size 16 contacts presses against the shoulder of the contact. The rear, or insulation support, of the size 20 contacts presses against an internal shoulder in the tool tip.

STEP 3: Dip the contact and tool tip in isopropyl alcohol (do not use any lubricant other than isopropyl alcohol). Hold the tool perpendicular to the rear of the connector. Beginning with the center cavity and working outwards in a circular pattern, insert the wired contact into the rear of the connector until the contact snaps into place. A light pull on the wire will ensure that the contact is locked securely.

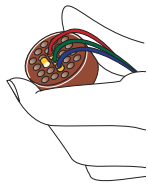

STEP 4: Fill any unused cavities with contacts. A wire hole filler must be inserted into the grommet behind the unused contacts to maintain the sealing integrity of the connector.



STEP 5: Check the mating face of the connector to ensure that all the same size contacts are on the same plane (fully inserted). If not, the contact is not fully inserted. Remove the contact using the proper extraction tool and procedure and re-insert. Do not attempt to reinsert the insertion tool to correct the problem.

STEP 6: Fixture the connector for re-assembly using the endbell assembly tools on [page 146](#) or a mating connector with contacts installed. Slide the connector accessories back down the cable over the rear of the connector and tighten. Torque as shown above.

EXTRACTION OF CONTACTS

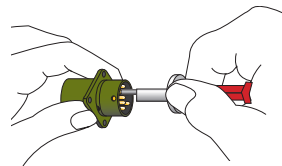
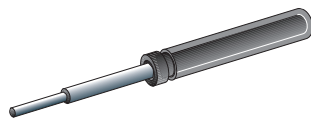

STEP 1: Remove the endbell accessories and slide them back over the wires.

STEP 2: Use the proper extraction tool from the chart on [page 133](#).

STEP 3: On the mating face of the connector, insert the tool over the contact and into the insulator until the tool bottoms. While keeping an even pressure against the tool, push the plunger on the tool shaft forward with your thumb and index finger. This will release the contact from the retention tine and push it toward the rear of the connector.

STEP 4: Carefully remove the extraction tool from the connector. Pull the wire by hand to completely remove the contact from the rear of the connector.

CONNECTOR TOOLS

TG70 STRAP WRENCH

The strap wrench is used to connect or disconnect coupling nuts in a confined space, or to tighten or loosen endbells without damaging the connector plating. A strap wrench also increases torque, allowing you to more easily mate or unmate a connector pair. Substitute tools, such as a pipe wrench or pliers, should never be used because of the high probability of severe damage to the connector plating or the coupling mechanism.



TG69P NON-MARRING ADJUSTABLE ENDBELL PLIERS FOR FIELD SERVICE

The TG69P pliers have resilient jaws and are used to tighten or remove endbells without damaging the connector plating. The pliers are adjustable and will accommodate all of the connector sizes in this catalog. Substitute tools, such as a pipe wrench or metal jaw pliers, should never be used due to the high probability of severe damage to the connector plating. Replacement jaws, part number G77015, are available.



The 600 series is a complete system for the proper assembly and torquing of connector endbells. The system includes a bench-mounted or hand-held torque wrench, plug and receptacle holders, and a range of endbell-tightening tools. When used together, these tools provide consistent endbell installations. Each item is shipped with detailed assembly instructions.



600-007
Bench-mounted torque wrench



600-004
Hand-held torque wrench

ROTATIONS	
PIN	SOCKET
W = G	W = H
X = I	X = J
Y = K	Y = L
Z = M	Z = N

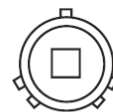

600D005-R

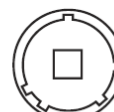

600D005-P

PLUG & RECEPTACLE HOLDERS		
SHELL SIZE	MIL-DTL-26482	
	FOR PT, PT-SE, MS311_, MS312_	
	RECEPTACLES	PLUGS
8	600D005-8R	600D005-8P
10	600D005-10R	600D005-10P
12	600D005-12R	600D005-12P
14	600D005-14R	600D005-14P
16	600D005-16R	600D005-16P
18	600D005-18R	600D005-18P
20	600D005-20R	600D005-20P
22	600D005-22R	600D005-22P
24	600D005-24R	600D005-24P

TORQUE VALUES

IMPORTANT NOTE:

If barrel/shell has three threads or less, torque to 30 to 35 inch/Lbs (3.4 to 4.0 NM) per L-725-2.

Endbell

SHELL SIZE	INCH-LBS.		N-M	
	MIN	MAX	MIN	MAX
6	20	26	2.3	2.9
8	20	26	2.3	2.9
10	26	32	2.9	3.6
12	30	36	3.4	4.1
14	40	46	4.5	5.2
16	50	55	5.6	6.2
18	60	65	6.8	7.3
20	75	80	8.5	9.0
22	85	90	9.6	10.2
24	100	110	11.3	12.4

Jam Nut

SHELL SIZE	INCH-LBS.		N-M	
	MIN	MAX	MIN	MAX
8	26	32	2.9	3.6
10	30	36	3.4	4.1
12	46	50	5.2	5.6
14	55	60	6.2	6.8
16	70	75	7.9	8.5
18	80	85	9.0	9.6
20	90	95	10.2	10.7
22	100	110	11.3	12.4
24	110	120	12.4	13.6

X-ON Electronics

Largest Supplier of Electrical and Electronic Components

Click to view similar products for [Circular MIL Spec Connector](#) category:

Click to view products by [Amphenol](#) manufacturer:

Other Similar products are found below :

[89075GULPR](#) [0025-262-542](#) [0025-264-3014](#) [58-570121-04S](#) [0134-213-1208](#) [0134-213-2209](#) [0025-258-000](#) [60-042022-07P](#) [60-042022-19P](#)
[60-042022-23P](#) [60-042217-10P](#) [0114-201-1278](#) [012-0467-000](#) [602GB06EG24-61SN](#) [0134-201-1207](#) [0134-213-1006](#) [6104-207-2302](#) [6104-](#)
[208-1902](#) [61-168211-04P](#) [61-168617-10P](#) [6131-202-19149P](#) [6131-204-21149P](#) [6131-208-13149P](#) [6131-209-17149P](#) [6131-210-11149P](#) [6131-](#)
[211-19149P](#) [6131-216-19149P](#) [6131-259-21149P](#) [6131-259-23149P](#) [6131-265-17149P](#) [6131-265-19149P](#) [CS3100A18-1P-472](#) [CS3100A-36-](#)
[77P](#) [CS3101A-16-55P](#) [CS3102A-10SL-55P](#) [CS3102A-14S-58P](#) [CS3102A-18-1P116](#) [CS3102A-32-17P](#) [CS3102A32-25S](#) [CS3102C18-4P-472](#)
[CS3106A10SL3S004](#) [CS3106A-18-73S](#) [CS3108A-14S-52S](#) [CS3108A-28-51S](#) [6162-233-1277](#) [6162-324-1231](#) [M243082296Z](#)
[M2884010AC1S1](#) [CT0-24-10SC](#) [CT0M20-7PCAU](#)