

THIS DOCUMENT IS SUBJECT TO CHANGE WITHOUT NOTICE. IT IS CONFIDENTIAL AND A PROPERTY OF AMPHENOL LTW. DISCLOSURE TO THIRD PARTY HAS TO BE AUTHORIZED BY AMPHENOL LTW.

REV.	ECN NO.	DATE	SIGN	DESCRIPTION
A	Initial Release	2016/06/30	Aric Ko	Rev. A
B	LEN1680169	2016/07/28	Aric Ko	Modify Drawing.

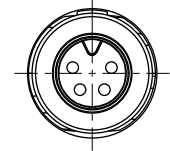
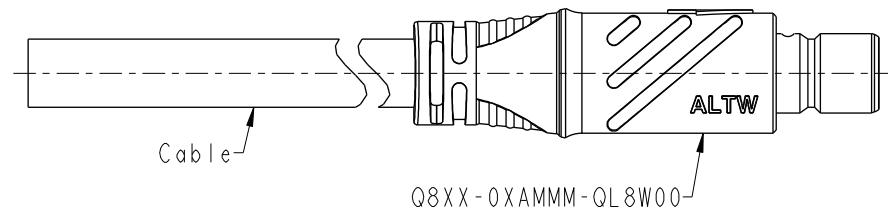
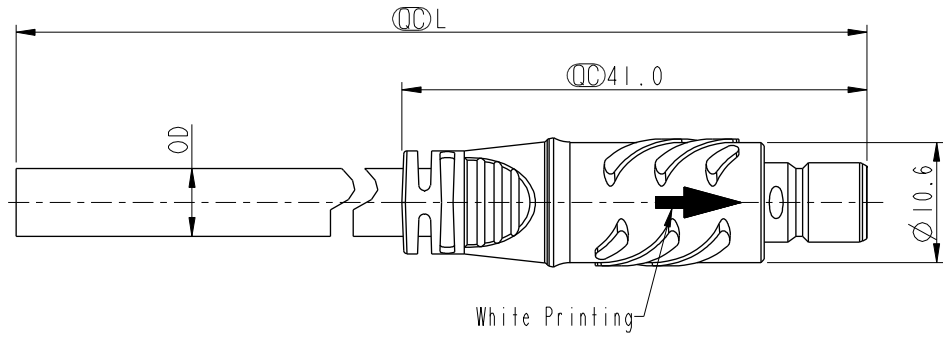
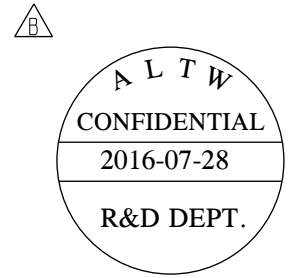

**Material Specification:**

- \* Connector: Thermoplastic
- \* Contacts: Copper Alloy, Gold Plated.
- \* UL Rated: UL 94V-0, fl
- \* Cable: UL Style, 24AWG(2A), 20AWG(5A), Sun Res., PVC Jacket, Black.
- \* RoHS Compliant

**Electrical Specification:**

- \* Contact Resistance: 10mΩ Max. (Without Cable)
- \* Insulation Resistance: 100MΩ Min.
- \* Dielectric Withstand Voltage: 1,000V Plus 2 Times the Rated Voltage.

**Mechanical Specification:**

- \* Durability: 2,000 Cycles
- \* Tensile Strength: 10 kgf

**Environmental Specification:**

- \* Waterproof Rating: IP68(Mated, 1M/24 Hours)
- \* Temperature Range: -40° C to 105° C
- \* Salt Spray: Mated, 500 Hours.
- \* Safety Compliance: UL 2238(Outdoor Use, UL 50e)

**Cable Length Tolerance:**

- 01M: ±40mm
- 02M~06M: ±60mm
- 06M~10M: ±100mm
- 11M~30M: ±200mm
- 31M~99M: ±500mm

UNIT:mm			TITLE SIZE 8, OVERMOLDED WITH CABLE HS-LOK, M CONN M PIN
TOLERANCE ±0.5 mm	SCALE 3:2	SIZE A4	SHEET 1 OF 2
	REV. B	WC-REV. A.6	QC: Inspection item

**Amphenol LTW**  
安費諾亮泰企業股份有限公司

ITEM NO	DRAWN BY Aric Ko	DATE 2016-07-29
DWG NO Q8XX-0XAMMM-QL8AXX	CHECKED BY Victor Hung	DATE 2016-07-29
CUSTOMER ALTW	APPROVED BY Kevin Hu	DATE 2016-07-29

THIS DOCUMENT IS SUBJECT TO CHANGE WITHOUT NOTICE. IT IS CONFIDENTIAL AND A PROPERTY OF Amphenol LTW. DISCLOSURE TO THIRD PARTY HAS TO BE AUTHORIZED BY Amphenol LTW.

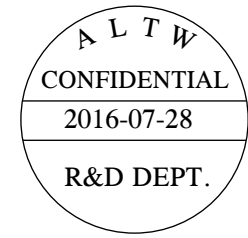

	5A, 300Vac/Vdc 2 Contacts(02) Cable OD 5.2mm; Wire Color Identification: 1.White, 2.Black
	5A, 300Vac/Vdc 3 Contacts(03) Cable OD 5.5mm; Wire Color Identification: 1.White, 2.Black, 3.Green
	5A, 300Vac/Vdc 4 Contacts(04) Cable OD 6.0mm; Wire Color Identification: 1.White, 2.Black, 3.Red, 4.Blue
	2A, 100Vdc 5 Contacts(05) Cable OD 5.5mm; Wire Color Identification: 1.White, 2.Black, 3.Red, 4.Blue, 5.Green
	2A, 100Vdc 6 Contacts(06) Cable OD 5.8mm; Wire Color Identification: 1.White, 2.Black, 3.Red, 4.Blue, 5.Green, 6.Brown
	5A, 300Vac + 2A, 100Vdc 2+3 Contacts(05) Cable OD 6.0mm; Wire Color Identification: 1.White, 2.Black, 3.Red, 4.Blue, 5.Green

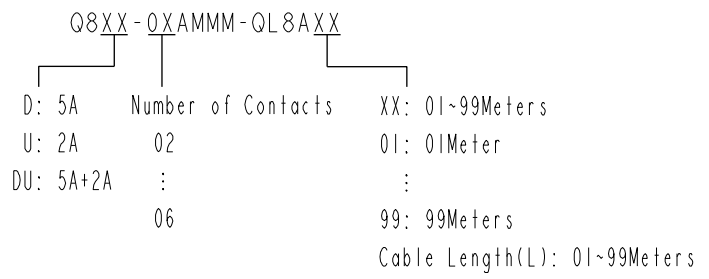

Pin Assignments, Front View

Ordering Information:



Mating Connector:

Overmolded with Cable: Q8XX-0XAFFM-QL8AXX

UNIT:mm			TITLE SIZE 8, OVERMOLDED WITH CABLE HS-LOK, M CONN M PIN
TOLERANCE ±0.5 mm			SCALE 3:2    SIZE A4    SHEET 2 OF 2
REV. B	WC-REV. A.6	QC: Inspection item	

**Amphenol LTW**  
安費諾亮泰企業股份有限公司

ITEM NO	DRAWN BY Aric Ko	DATE 2016-07-29
DWG NO Q8XX-0XAMMM-QL8AXX	CHECKED BY Victor Hung	DATE 2016-07-29
CUSTOMER ALTW	APPROVED BY Kevin Hu	DATE 2016-07-29

## X-ON Electronics

Largest Supplier of Electrical and Electronic Components

*Click to view similar products for [Sensor Cables / Actuator Cables](#) category:*

*Click to view products by [Amphenol](#) manufacturer:*

Other Similar products are found below :

[60963](#) [60964](#) [703000D02F2002](#) [703001D02F0602](#) [703001D02F300](#) [704000D02F120](#) [773032K02F030](#) [802027107404-1](#) [802027213811-1](#)  
[804001A09M150](#) [805001A09M0502](#) [84914-0235](#) [84914-0237](#) [885030A09M020](#) [8R4J30E03C3003](#) [1200651332](#) [1200651713](#) [1200660844](#)  
[1200660845](#) [1200661173](#) [1200680071](#) [1200720053](#) [1200720081](#) [1200720099](#) [1200720217](#) [1200800231](#) [1200860125](#) [1200870123](#)  
[1200980102](#) [1200650267](#) [1200650298](#) [1200660183](#) [1200660782](#) [1200660849](#) [1200661295](#) [1200661297](#) [1200661342](#) [1200661343](#)  
[1200670080](#) [1200670220](#) [1200680331](#) [1200720252](#) [1200730184](#) [1200860344](#) [1200870359](#) [1200870643](#) [1200980008](#) [1200980031](#)  
[1210502211](#) [1210400542](#)