

REVISIONS					
REV	ECD	DESCRIPTION	DATE	BY	APPR
01	-	CUSTOMER DRAWING	-	-	-

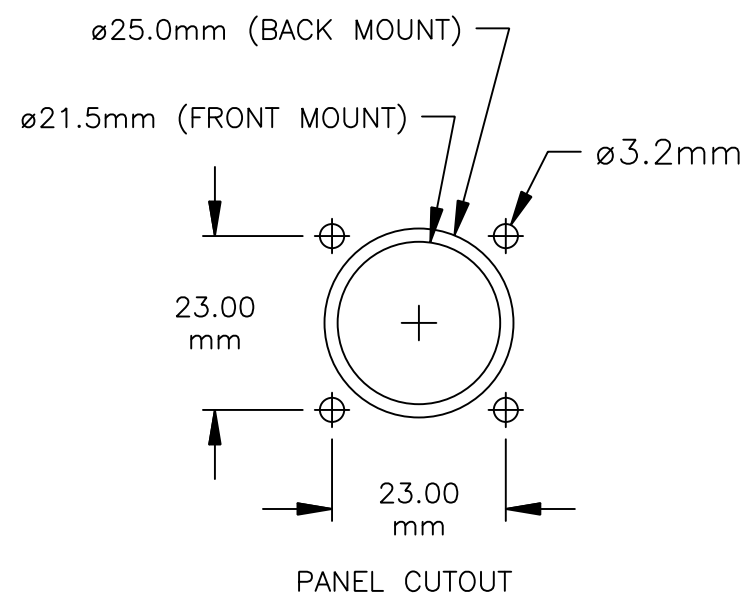
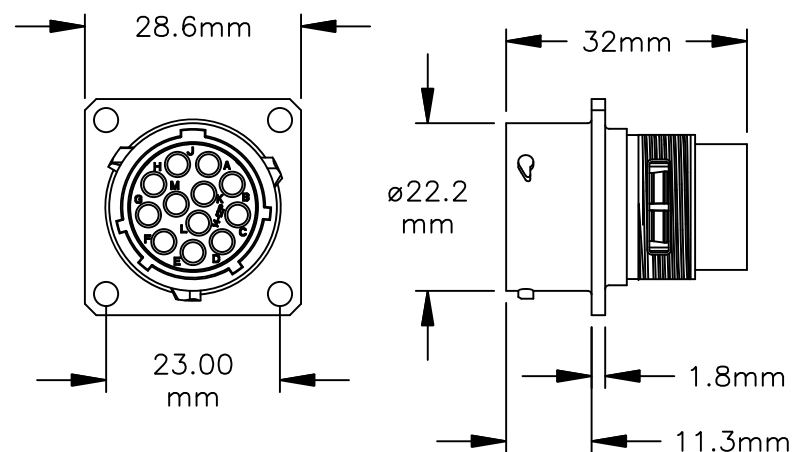
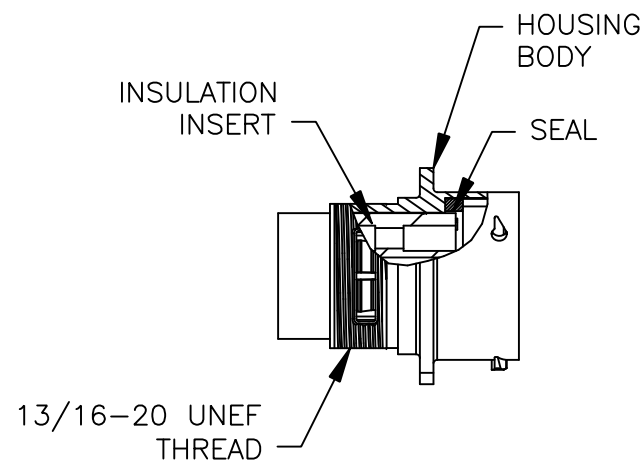
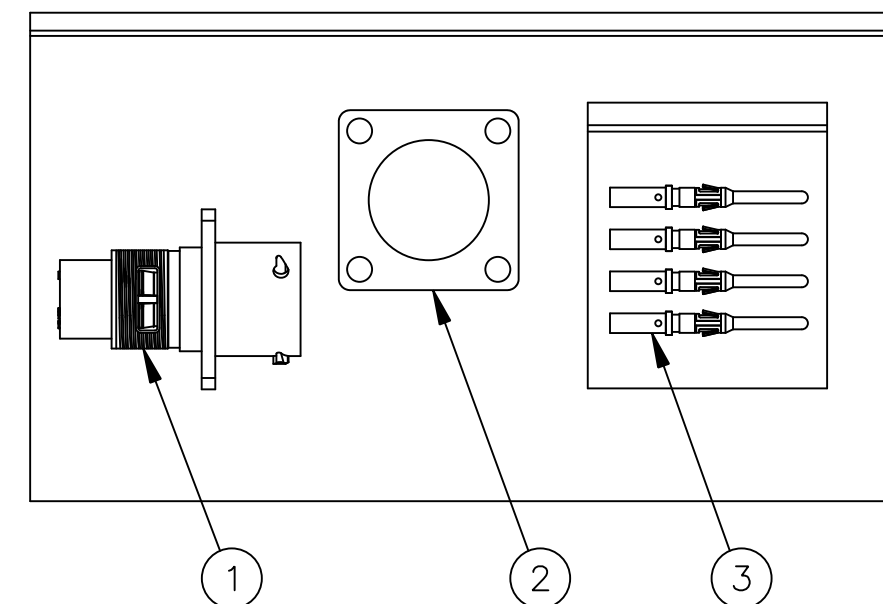

ILLUSTRATION: COMPLETE KIT



NOTES:

- 1) CONTACT BARREL RANGE: 16AWG TO 18AWG
- 2) RECOMMENDED CRIMP TOOLS:  
HAND CRIMPER: MFX-3959  
PNEUMATIC CRIMPER: MFX-3960
- 3) EXTRACTION TOOL: QXRT16
- 4) MATERIALS:  
HOUSING BODY: ZINC DIE CAST, NICKEL PLATED  
INSULATION INSERT: PA66, UL94/V-0  
CONTACT: BRASS, GOLD FLASH PLATED  
SEAL: NBR (NITRILE BUTADIENE RUBBER)
- 5) ELECTRICAL DATA:  
a) CURRENT (MAX): 13A  
b) VOLTAGE (MAX): 250V AC/DC  
c) INSULATION RESISTANCE (MIN): 5000M OHMS  
d) TEST VOLTAGE (BETWEEN CONTACTS): 3050V

6) TECHNICAL DATA:

- a) TEMPERATURE RANGE: -40°C TO 105°C
- b) PROTECTION: IP67 (MATED CONDITION)
- c) MATING CYCLES: >500
- d) VIBRATION RESISTANCE PER MIL-STD-202 METHOD 204
- e) THERMAL SHOCK PER MIL-STD-202 METHOD 207
- f) 48 HOUR SALT SPRAY PER MIL-STD-202 METHOD 101

7) RoHS COMPLIANT

QUANTITY	PART NUMBER	DESCRIPTION	ITEM
12	MP16M23F	CONTACT, PIN, SIZE 16	3
1	RTFD14B	GASKET	2
1	RT001412PNH	CONNECTOR	1

MATERIALS LIST			
UNLESS OTHERWISE SPECIFIED 1) All dimensions are in metric(mm). 2) Tolerances are as follows: 1 PL DEC ±0.30 2 PL DEC ±0.15 3 PL DEC ±0.08 Fractions ±1/64 Angles ±1° 3) Note reference =		SIGNATURES DRAWN: MRF CHECKED: ENGINEER: APPROVAL:	DATE 10SEP13
MATERIAL SPECIFICATIONS:		CUSTOMER:	
PROCESS SPECIFICATIONS:		THIS DRAWING IS SUPPLIED FOR INFORMATION ONLY. DESIGN FEATURES, SPECIFICATIONS AND PERFORMANCE DATA SHOWN HEREON ARE THE PROPERTY OF THE AMPHENOL CORPORATION. NO RIGHTS OF REPRODUCTION ARE IMPLIED. ALL DIMENSIONS ARE SUBJECT TO NORMAL MANUFACTURING VARIATIONS.	
NEXT ASSY:		SCALE: NONE	REVISION
		SIZE: B C-	DWG NO: RT001412PNH-K
			REVISION: 01
		SHEET 1 OF 1	

TITLE:

KIT, ECO-MATE

DWG NO:

REV: 01

SH: 1

DF: 1

## X-ON Electronics

Largest Supplier of Electrical and Electronic Components

*Click to view similar products for [Standard Circular Connector](#) category:*

*Click to view products by [Amphenol](#) manufacturer:*

Other Similar products are found below :

[5M2530B10P](#) [600259N006](#) [600273N007](#) [6134-336-13149](#) [6134-337-11149](#) [6134-337-2390](#) [6134-341-17149](#) [6280-4SG-516](#) [6280-7SG-3DC](#)  
[6290](#) [6291A](#) [66200A-10](#) [680-SMG](#) [681-PMG](#) [CXS3102A14S2P](#) [CXS3102A181S](#) [7251-6SG-300](#) [7271-6SG-300](#) [7282-3PG-300-CH3](#) [75-](#)  
[474014-05S](#) [75-474618-01S](#) [75-474618-04P](#) [75-474618-04S](#) [799539-000](#) [MI8-SE](#) [805-005-07NF11-19PC](#) [805-005-07NF15-7PA](#) [8280-4PG-](#)  
[516](#) [8280-7PG-519](#) [8282-5PG-519](#) [836783-1](#) [MP-4102-25P-C](#) [862256-1](#) [864019-2](#) [866857-1](#) [867865-1](#) [PT01SP-14-18P](#) [PT08P-14-5S](#)  
[PTSF06SE-14-12S](#) [120-1833-000](#) [QCM019PC2DC012B](#) [1-2069279-1](#) [121583-0217](#) [121667-0020](#) [129591AU](#) [1000B BULK](#) [RD10A16-19-](#)  
[P6CS051/1](#) [RD10A20-31-P8CS051/1](#) [RD16A14-12-S6CS051/2](#) [1301240290](#) [1301240347](#)