

This document is the property of Amphenol Corporation and is delivered on the express condition that it is not to be disclosed, reproduced or used, in whole or in part, for manufacture or sale by a person other than Amphenol Corporation without its prior approval. It shall not be lent, copied, distributed or be used in any manner without the written consent of Amphenol Corporation.

REVISIONS

SYM	ECN	DESCRIPTION	DATE	APPROVED
B	HC315D	REVISED Material Housing Thermoplastic WAF Material Housing PPA 2395 Glass filled	9/28/04	IP

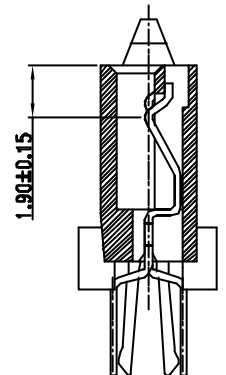
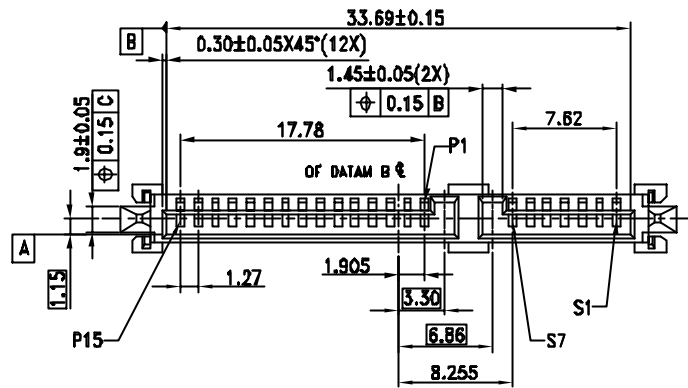

SECTION P-P 2:1

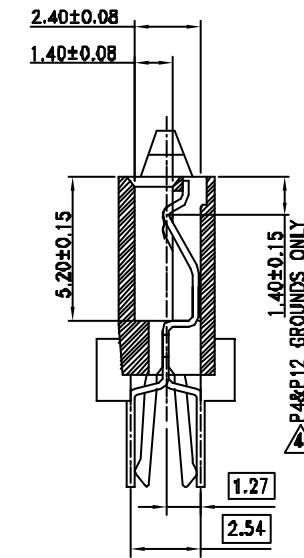
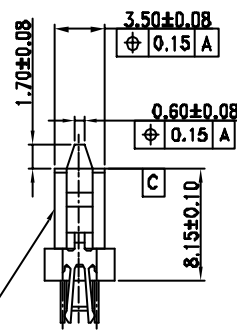
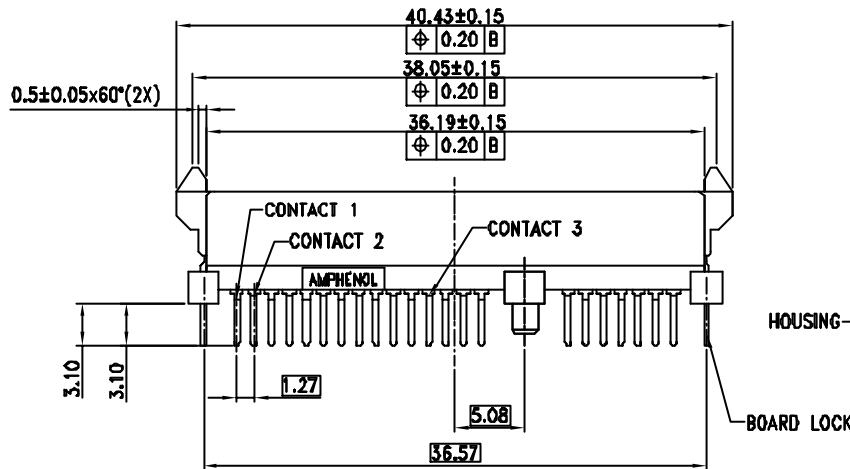

SECTION N-N 2:1

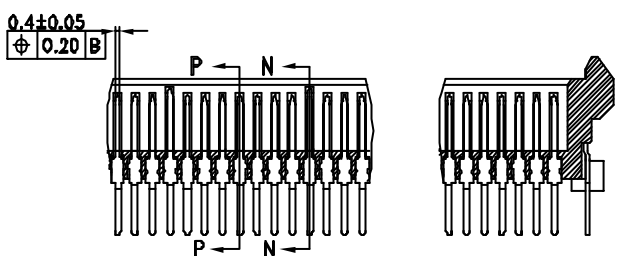
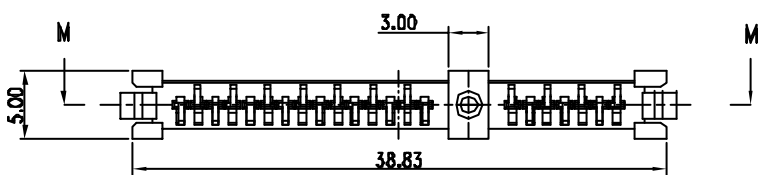

SECTION M-M

CUSTOMER DRAWING

- NOTES:
1. Material HOUSING: THERMOPLASTIC, UL94V-0
 COLOR: BLACK
 CONTACT: PHOSPHOR BRONZE
 PLATING: UNDER PLATING WITH NICKEL
 OVER PLATING WITH GOLD ON MATING AREA
 GOLD PLATING THICKNESS REFER TO P/N SYSTEM
 TIN/LEAD PLATING ON TERMINAL
 2. ELECTRICAL SPECIFICATION: OPERATION VOLTAGE: 100 V AC MAX.
 CURRENT RATING: 1.5A PER CONTACT
 CONTACT RESISTANCE: 30 MILLIOHMS MAX.
 INSULATOR RESISTANCE: 1000MEG OHM MIN.
 DIELECTRIC WITHSTANDING VOLTAGE: 500 V AC
 3. MATERIAL SHOULD BE FILLED AMPHENOL SPEC# SSSN01.
 4. PREMATING AT P4 & P12
 5. RECOMMENDED PCB THICKNESS 2.35±0.15
 6. ORDER P/N SYSTEM: SATA-112-014-X

MATING AREA PLATING
 1-Au 0.76um MIN.
 2-Au 0.38um MIN.
 A-Au FLASH 3u"

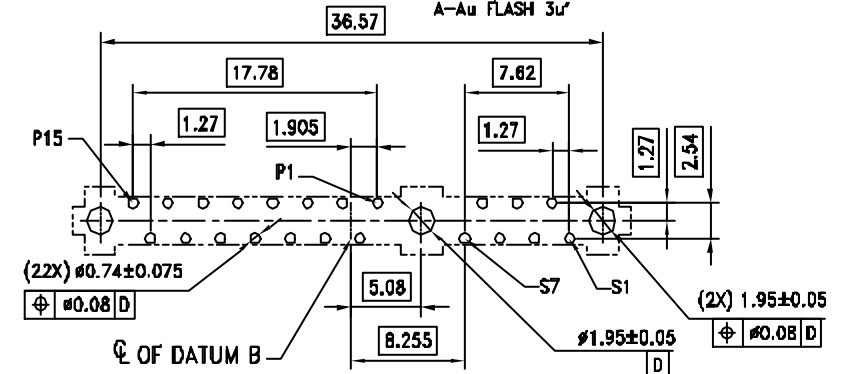

RECOMMENDED PCB LAYOUT

ITEM NO	PART OR IDENTIFICATION NO	NUMERICAL OR DESCRIPTION	QTY REQ'D
PARTS LIST			
UNLESS OTHERWISE SPECIFIED TOLERANCES		APPROVAL	DATE
U.S.		DRAWN	9/28/04
METRIC		CHECKED	9/28/04
.X		<div style="text-align: center;"> </div>	
.001			
.01			
FRACTIONS +/-		TITLE	
ANGLES +/-		SATA 7+15P 2IN1 FEMALE	
FOR MATERIALS AND FINISHES SEE SPEC		DRAWING FILE :	
REMOVE SHARP EDGES		SATA/CSATA112014C.DWG	
DIMENSIONS		ANGLE OF PROJECTION	
U.S. INCHES		<div style="text-align: center;"> </div>	
(METRIC) (MM)			
SIZE		DRAWING NO.	
A3		C-SATA-112-014-X	
SCALE		NONE	
SHEET		1 OF 1	

X-ON Electronics

Largest Supplier of Electrical and Electronic Components

Click to view similar products for [I/O Connectors](#) category:

Click to view products by [Amphenol](#) manufacturer:

Other Similar products are found below :

[571763P](#) [58098-0628](#) [72.250.1628.2](#) [72.250.2428.2](#) [74720-0505](#) [76.350.0729.0](#) [76871-1403](#) [FCN-244F080-G/1](#) [FCN-260A9920](#) [MP-5T180MUNNA-005](#) [PCR-E36PM](#) [PCS-XE26MA+](#) [G38A71314B](#) [1571250010](#) [157-22500-3](#) [MS3471L14-19P L/C](#) [192991-0703](#) [172501-4002](#) [172501-6002](#) [FCN-260C008-A/L0](#) [FCN-260C024-AL0](#) [FCN-261Z008](#) [2000314-1](#) [200331-1](#) [PCR-E36FC+](#) [PCS-E28FS+](#) [PCS-XE26SLFD+](#) [PCS-XE26SLFDT+](#) [G730VID08BDC24](#) [U90B2054081210](#) [UE86K842720321](#) [38113800006](#) [DP3AR020WQ1R200](#) [Z4.102.0680.0](#) [500-1040](#) [500-1052](#) [500-1054](#) [ZP-4008-66L](#) [0709821002](#) [DX40-20P\(55\)](#) [5554841-1](#) [MS3474W18-8P-LC*](#) [U90B3054061110](#) [U65-E04-4020](#) [ZPF000000000097891](#) [557-262M2-06C](#) [747360449](#) [10099439-003C-TRLF](#) [10137239-0021LF](#) [E9320-001-01](#)