

THIS DOCUMENT IS SUBJECT TO CHANGE WITHOUT NOTICE. IT IS CONFIDENTIAL AND A PROPERTY OF Amphenol LTW. DISCLOSURE TO THIRD PARTY HAS TO BE AUTHORIZED BY Amphenol LTW.

REV.	ECN NO.	DATE	SIGN	DESCRIPTION
F	LEN1750030~41	2017/04/25	Lingpeng	Add 5Pin
G	LEN1790175~90	2017-08-29	Lingpeng	Update The Note
H	NI80019	2019-03-14	Peng	Add All Seals Product

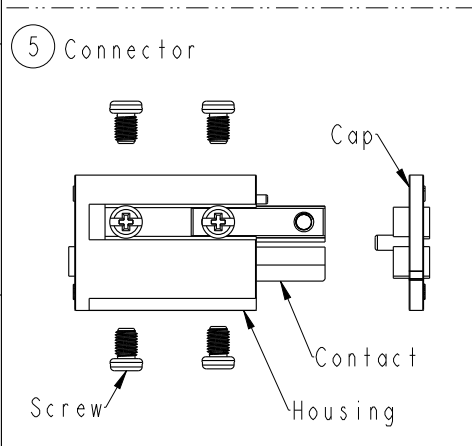

**ALTW**  
**CONFIDENTIAL**  
 2019-03-14  
**R&D DEPT.**

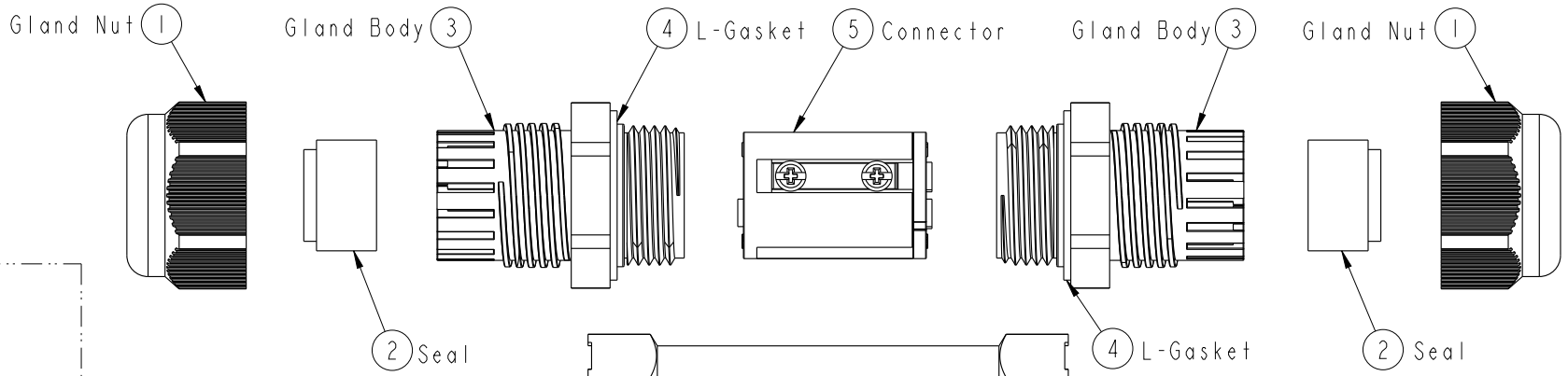
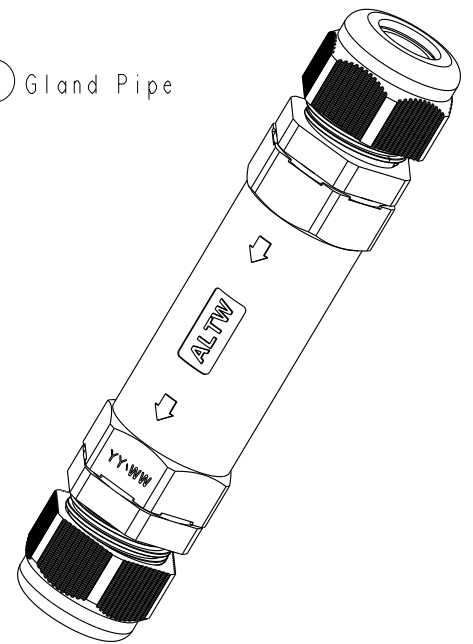
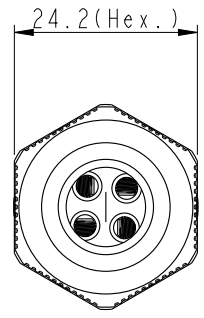
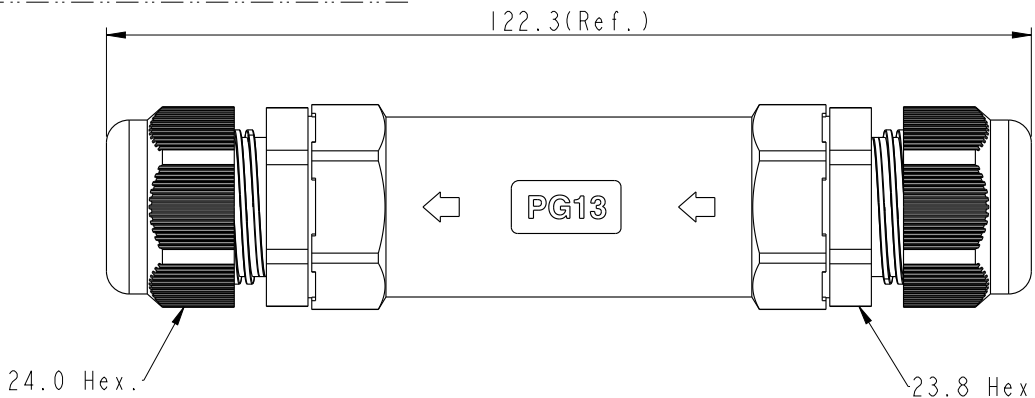
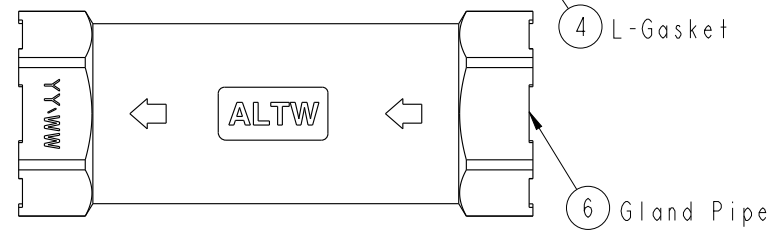

UNIT:mm	
TOLERANCE	±0.5mm

TITLE PG13 Cable Joiner Screw-in Type			
SCALE 1:1	SIZE A4	SHEET 1 OF 2	
REV. H	WC-REV. A.10	QC: Inspection item	

**Amphenol LTW**  
 安費諾亮泰企業股份有限公司

ITEM NO.	DRAWN BY Peng	DATE 2019-03-14
DWG NO. SC-L-PG13-XX-XX	CHECKED BY Ma Fei	DATE 2019-03-14
CUSTOMER ALTW	APPROVED BY Jerry	DATE 2019-03-14

THIS DOCUMENT IS SUBJECT TO CHANGE WITHOUT NOTICE. IT IS CONFIDENTIAL AND A PROPERTY OF Amphenol LTW. DISCLOSURE TO THIRD PARTY HAS TO BE AUTHORIZED BY Amphenol LTW.

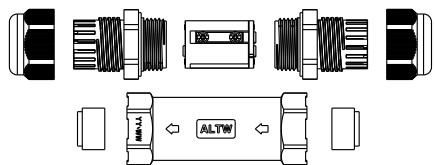

QTY: 1PCS

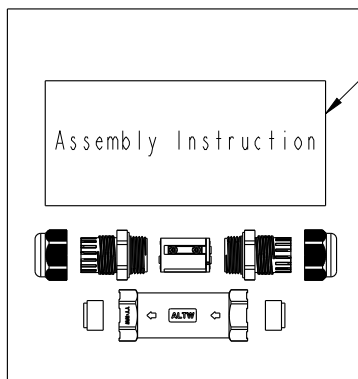
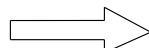

QTY: 105PCS

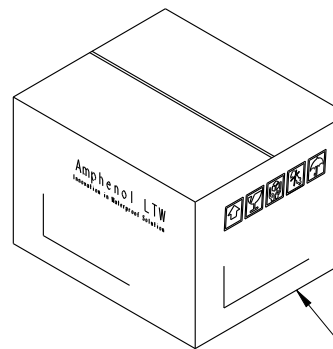
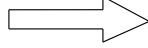

9 Carton

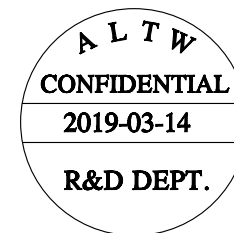

Both A Unassembled product And An Instruction Are In A PE Bag.  
(將一套未組裝的產品和說明書, 放置於一個PE袋, 並封口)

SC-L-PG13-XX-XX  
L: Cable Joiner  
Type: PG13

Seal's Color: BL-Blue(藍色) For Cable Range:  $\varnothing 4.5\sim\varnothing 6.5\text{mm}$   
 YW-Yellow(黃色) For Cable Range:  $\varnothing 6.5\sim\varnothing 8.5\text{mm}$   
 GN-Green(綠色) For Cable Range:  $\varnothing 8.5\sim\varnothing 10.5\text{mm}$   
 RD-Red(紅色) For Cable Range:  $\varnothing 10.5\sim\varnothing 11.5\text{mm}$   
 AA-All Seals For Cable Range:  $\varnothing 4.5\sim\varnothing 11.5\text{mm}$

No. of Conductor: 02-2Poles  
 03-3Poles  
 04-4Poles  
 05-5Poles

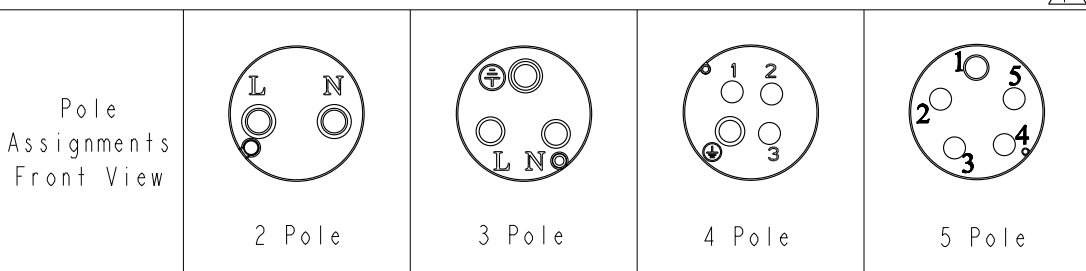

Note:  $\triangle G$   $\triangle H$

- \*  $\text{⌀}$  Important Dimension To Check.
- \* Waterproof Rate: IP68 (50M,24H)
- \* Housing & Cap: PA66+GF, Black.
- \* Gland Pipe: PA66, Black.
- \* Gland Body: PA66, Black.
- \* Gland Nut: PA6+GF, Black.
- \* Contact: Brass, Nickel Plated
- \* L-Gasket : Silicone, Yellow.
- \* Seal: Silicone, Blue & Yellow & Green & Red.
- \* Rated Voltage: 2~5 Pole 450V AC
- \* Rated Current: 2 & 3 Pole Max. 20A ,  
 4 Pole Max. 15A.  
 5 Pole Max. 8A.
- \* Operating Temperature:  $-40^{\circ}\sim+105^{\circ}$ .
- \* Gland Pipe Recommended Tightening Torque:  
 8~10 Kgf.cm(0.78~0.98 N.m)
- \* Gland Nut Recommended Tightening Torque:  
 8~10 Kgf.cm(0.78~0.98 N.m)
- \* Seal For Cable OD:  $\varnothing 4.5\sim\varnothing 6.5\text{mm}$ , Blue.  
 $\varnothing 6.5\sim\varnothing 8.5\text{mm}$ , Yellow.  
 $\varnothing 8.5\sim\varnothing 10.5\text{mm}$ , Green .  
 $\varnothing 10.5\sim\varnothing 11.5\text{mm}$ , Red.
- \* Screws for Wire connection recommended tightening torque: 2.00~4.50 kgf.cm / 0.196~0.44 N.m
- \* Applicable Wire gauge (Stranded wire cross section)  $0.75\text{mm}^2$  (18AWG) ~  $2.5\text{mm}^2$  (14AWG)

UNIT:mm		TITLE PG13 Cable Joiner Screw-in Type	
TOLERANCE	$\pm 0.5\text{mm}$ $\triangle H$	SCALE 1:1	SIZE A4
		REV. H	WC-REV. A.10
		SHEET 2 OF 2	
		QC: Inspection item	

**Amphenol LTW**  
 安費諾亮泰企業股份有限公司

ITEM NO	DRAWN BY Peng	DATE 2019-03-14
DWG NO SC-L-PG13-XX-XX	CHECKED BY Ma Fei	DATE 2019-03-14
CUSTOMER ALTW	APPROVED BY Jerry	DATE 2019-03-14

## X-ON Electronics

Largest Supplier of Electrical and Electronic Components

*Click to view similar products for [Standard Circular Connector](#) category:*

*Click to view products by [Amphenol](#) manufacturer:*

Other Similar products are found below :

[5M2530B10P](#) [600259N006](#) [600273N007](#) [6134-336-13149](#) [6134-337-11149](#) [6134-337-2390](#) [6134-341-17149](#) [6280-4SG-516](#) [6280-7SG-3DC](#)  
[6290](#) [6291A](#) [66200A-10](#) [680-SMG](#) [681-PMG](#) [CXS3102A14S2P](#) [CXS3102A181S](#) [7251-6SG-300](#) [7271-6SG-300](#) [7282-3PG-300-CH3](#) [75-](#)  
[474014-05S](#) [75-474618-01S](#) [75-474618-04S](#) [799539-000](#) [MI8-SE](#) [805-005-07NF11-19PC](#) [805-005-07NF15-7PA](#) [8280-4PG-516](#) [8280-7PG-](#)  
[519](#) [8282-5PG-519](#) [836783-1](#) [MP-4102-25P-C](#) [862256-1](#) [864019-2](#) [866857-1](#) [867865-1](#) [PT01SP-14-18P](#) [PT08P-14-5S](#) [PTSF06SE-14-12S](#)  
[120-1833-000](#) [QCM019PC2DC012B](#) [1-2069279-1](#) [121583-0217](#) [121667-0020](#) [129591AU](#) [1000B BULK](#) [RD10A16-19-P6CS051/1](#)  
[RD10A20-31-P8CS051/1](#) [RD16A14-12-S6CS051/2](#) [1301240290](#) [1301240347](#) [1301860202](#)