



NUMBER SC-SFW 14	TYPE PRODUCT SPECIFICATION		
TITLE FPC/FFC CONNECTOR (SFW_R-1/2STAE_LF/SFW_R-1/2STGE_LF/SFW_R-1/2STGHE_LF)		PAGE 1 of 11	REVISION G
		AUTHORIZED BY M.YAMASHITA	DATE 24 Nov 09
		CLASSIFICATION UNRESTRICTED	

Table of Contents:

1	SCOPE	3
2	APPLICABLE STANDARDS	3
3	CATALOG NO. STRUCTURE	3
4	CONNECTOR SHAPE, DIMENSIONS AND MATERIALS	3
5	ACCOMMODATED CONDUCTORS (FPC)	3
6	PACKAGING CONDITION	3
7	RECOMMENDED MOUNTING PATTERN DIMENSIONS	3
8	RATING	4
	8-1 Voltage	4
	8-2 Current	4
	8-3 Operating Temperature	4
9	PERFORMANCE CHARACTERISTICS	4
	9-1 Electrical Performance	4
	9-1-1 Contact resistance	4
	9-1-2 Insulation resistance	5
	9-1-3 Dielectric withstanding voltage	5
	9-2 Mechanical Performance	5
	9-2-1 Durability (Slider operation)	5
	9-2-2 Vibration (Sinusoidal)	5

NUMBER SC-SFW 14	TYPE PRODUCT SPECIFICATION		
TITLE FPC/FFC CONNECTOR (SFW_R-1/2STAE_LF/SFW_R-1/2STGE_LF/SFW_R-1/2STGHE_LF)		PAGE 2 of 11	REVISION G
		AUTHORIZED BY M.YAMASHITA	DATE 24 Nov 09
		CLASSIFICATION UNRESTRICTED	

9-3	Environmental Performance	6
9-3-1	Damp heat (Steady state)	6
9-3-2	Salt spray	6
9-3-3	Change of temperature	7
9-4	Other performance	8
9-4-1	Soldering (Resistance to reflow soldering)	8
9-4-2	Soldering (Solderability) (Reflow)	9
9-4-3	Conductor retention force (Reference)	9
10	INDICATION AND PACKAGING	10
10-1	Indication	10
10-2	Packaging	10
11	REMARKS	10
12	RECOMMENDED REFLOW PROFILE	10
13	REVISION RECORD	11

NUMBER SC-SFW 14	TYPE PRODUCT SPECIFICATION		
TITLE FPC/FFC CONNECTOR (SFW_R-1/2STAE_LF/SFW_R-1/2STGE_LF/SFW_R-1/2STGHE_LF)		PAGE 3 of 11	REVISION G
		AUTHORIZED BY M.YAMASHITA	DATE 24 Nov 09
		CLASSIFICATION UNRESTRICTED	

1. SCOPE

This specification covers the requirements for the connector (SFW__R-1/2ST_E_LF) with 1mm spacing to which the edge of FPC(Flexible Printed Circuit) can be connected by Zero-Insertion-Force method and which copes with automatic mounting and SMT.

2. APPLICABLE STANDARDS

- JIS C 5402 Method for Test of Connectors for Electronic Equipment
- JIS C 0806 Packaging of Electronic Components on Continuous Tapes
 (Surface Mount Components)
- UL - 94 TESTS FOR FLAMMABILITY OF PLASTIC MATERIALS FOR PARTS
 IN DEVICES AND APPLIANCES

3. CATALOG NO. STRUCTURE

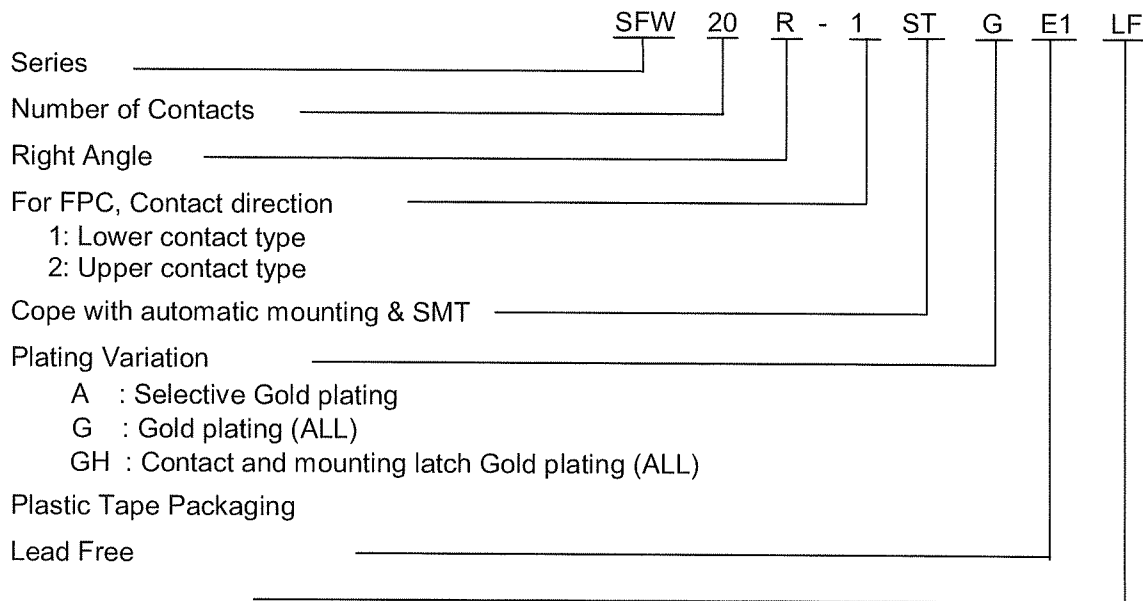

4. CONNECTOR SHAPE, DIMENSIONS AND MATERIALS

Refer product drawings.

5. ACCOMMODATED CONDUCTORS (FPC)

Refer product drawings.

6. PACKAGING CONDITION

Refer product drawings.

7. RECOMMENDED MOUNTING PATTERN DIMENSIONS

Refer product drawings.

NUMBER SC-SFW 14	TYPE PRODUCT SPECIFICATION		
TITLE FPC/FFC CONNECTOR (SFW_R-1/2STAE_LF/SFW_R-1/2STGE_LF/SFW_R-1/2STGHE_LF)		PAGE 4 of 11	REVISION G
		AUTHORIZED BY M.YAMASHITA	DATE 24 Nov 09
CLASSIFICATION UNRESTRICTED			

8. RATING

- 8-1. Voltage : A.C. 100V D.C. 100V
- 8-2. Current : A.C. 1A D.C. 1A (Refer to the following note.)
- 8-3. Operating Temperature : -55°C ~ +105°C (Including terminal temperature rise)

NOTE

Allowable maximum current for one contact is 1A. Total allowable current for a whole connector is the value which is shown in the following figure.

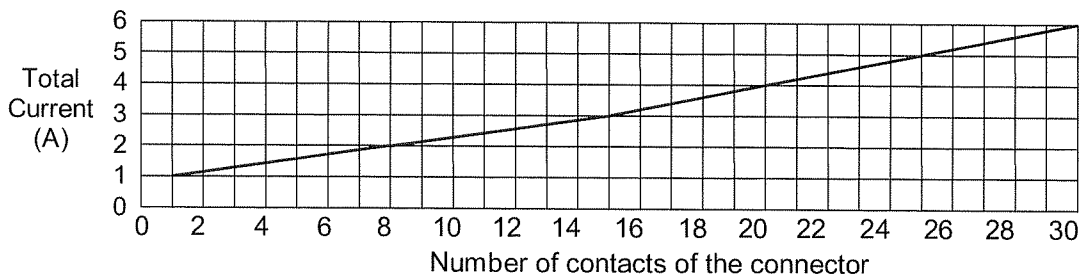

9. PERFORMANCE CHARACTERISTICS

9-1. Electrical Performance

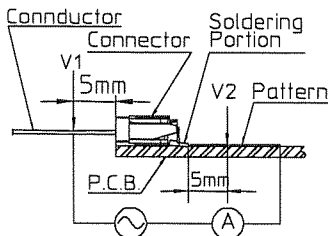
No.	Test Item	Test Method	Requirements
9-1-1	Contact resistance	1) Measure contact resistance between V_1 - V_2 by voltage drop method by the following circuit by mating accommodated conductor stipulated in clause 5 after reflow soldering the connector on the P.C.B. and cleaning flux dregs.  2) Open circuit voltage : Less than A.C. 20mV 3) Test current : Less than A.C. 20mA	1) Initial value : Less than 30mΩ 2) Contact resistance after the test is in accordance with the value specified in each test item.

NUMBER SC-SFW 14	TYPE PRODUCT SPECIFICATION		
TITLE FPC/FFC CONNECTOR (SFW_R-1/2STAE_LF/SFW_R-1/2STGE_LF/SFW_R-1/2STGHE_LF)		PAGE 5 of 11	REVISION G
		AUTHORIZED BY M.YAMASHITA	DATE 24 Nov 09
CLASSIFICATION UNRESTRICTED			

No.	Test Item	Test Method	Requirements
9-1-2	Insulation resistance	1) Measure insulation resistance between adjacent contacts in a connector individual. 2) Test voltage : D.C. 500V 3) Read value one minute after applying test voltage.	1) More than 500MΩ
9-1-3	Dielectric withstanding voltage	1) For one minute, apply A.C. 500V between adjacent contacts in a connector individual. 2) Set current : A.C. 1mA	1) Free from any short circuit and insulation breakdown.

9-2. Mechanical Performance

No.	Test Item	Test Method	Requirements
9-2-1	Durability (Slider operation)	1) Measure contact resistance before and after the test by the method in clause 9-1-1 by mating the accommodated conductor specified in clause 5. 2) Number of slider open and close : 20 times (Insert and extract the conductor for each opening of the slider.)	1) Initial contact resistance : Less than 30mΩ 2) Contact resistance after the test : Less than 50mΩ 3) Free from any defect such as break etc. on the connector and the conductor.
9-2-2	Vibration (Sinusoidal)	JIS C 60068-2-6 (IEC60068-2-6) 1) Frequency range : 10 ~ 500Hz 2) Amplitude : 0.75mm or Acceleration : 100m/s ² 3) Sweep rate : 1 octave / minute 4) Kind of test : Sweep endurance test 5) Test time : 10 cycles	1) During the test, no circuit opening for more than 1μs 2) Free from any defect such as break, deformation, loosening and falling off etc. on each portion of the connector.

NUMBER SC-SFW 14	TYPE PRODUCT SPECIFICATION		
TITLE FPC/FFC CONNECTOR (SFW_R-1/2STAE_LF/SFW_R-1/2STGE_LF/SFW_R-1/2STGHE_LF)		PAGE 6 of 11	REVISION G
		AUTHORIZED BY M.YAMASHITA	DATE 24 Nov 09
CLASSIFICATION UNRESTRICTED			

9-3. Environmental Performance

No.	Test Item	Test Method	Requirements
9-3-1	Damp heat (Steady state)	<p>JIS C 60068-2-78 (IEC60068-2-78)</p> <ol style="list-style-type: none"> 1) Measure contact resistance before and after the test by the method in clause 9-1-1 by using the accommodated conductor specified in clause 5. 2) Measure insulation resistance after the test by the method in clause 9-1-2. 3) Bath temperature : 40°C 4) Bath humidity: 90~95% (Relative humidity) 5) Period of exposure : 48 hours 6) Expose conductor and connector in mated condition and leave them under normal temperature. (Without insertion and separation) 	<ol style="list-style-type: none"> 1) Initial contact resistance : Less than 30mΩ 2) Contact resistance after the test : Less than 50mΩ 3) Insulation resistance after the test : More than 100MΩ
9-3-2	Salt spray	<p>JIS C 60068-2-11 (IEC60068-2-11)</p> <ol style="list-style-type: none"> 1) Measure contact resistance before and after the test according to the method in clause 9-1-1 by using accommodated conductor specified in clause 5. 2) Salt solution concentration : 5% 3) Period of exposure : 48 hours 4) Expose conductor and connector in mated condition and leave them under normal temperature after post treatment. 	<ol style="list-style-type: none"> 1) Initial contact resistance : Less than 30mΩ 2) Contact resistance after the test : Less than 50mΩ

NUMBER SC-SFW 14	TYPE PRODUCT SPECIFICATION		
TITLE FPC/FFC CONNECTOR (SFW_R-1/2STAE_LF/SFW_R-1/2STGE_LF/SFW_R-1/2STGHE_LF)		PAGE 7 of 11	REVISION G
		AUTHORIZED BY M.YAMASHITA	DATE 24 Nov 09
CLASSIFICATION UNRESTRICTED			

No.	Test Item	Test Method	Requirements															
9-3-3	Change of temperature	<p>JIS C 0025 (IEC60068-2-14)</p> <p>1) Measure contact resistance before and after the test according to the method in clause 9-1-1 by using accommodated conductor in clause 5.</p> <p>2) One cycle of temperature is as follow and test 5 cycles.</p> <table border="1"> <thead> <tr> <th>Step</th> <th>Temp.(°C)</th> <th>Time (min.)</th> </tr> </thead> <tbody> <tr> <td>1</td> <td>-55±3</td> <td>30</td> </tr> <tr> <td>2</td> <td>25±2</td> <td>2 ~ 3</td> </tr> <tr> <td>3</td> <td>85±2</td> <td>30</td> </tr> <tr> <td>4</td> <td>25±2</td> <td>2 ~ 3</td> </tr> </tbody> </table> <p>3) Expose conductor and connector in mated condition and leave them under normal temperature.</p>	Step	Temp.(°C)	Time (min.)	1	-55±3	30	2	25±2	2 ~ 3	3	85±2	30	4	25±2	2 ~ 3	<p>1) Initial contact resistance : Less than 30mΩ</p> <p>2) Contact resistance after the test : Less than 50mΩ</p> <p>3) Free from any defect such as crack, warping and deformation etc. on each portion of the connector.</p>
Step	Temp.(°C)	Time (min.)																
1	-55±3	30																
2	25±2	2 ~ 3																
3	85±2	30																
4	25±2	2 ~ 3																

NUMBER SC-SFW 14	TYPE PRODUCT SPECIFICATION		
TITLE FPC/FFC CONNECTOR (SFW_R-1/2STAE_LF/SFW_R-1/2STGE_LF/SFW_R-1/2STGHE_LF)		PAGE 8 of 11	REVISION G
		AUTHORIZED BY M.YAMASHITA	DATE 24 Nov 09
CLASSIFICATION UNRESTRICTED			

9-4. Other performance

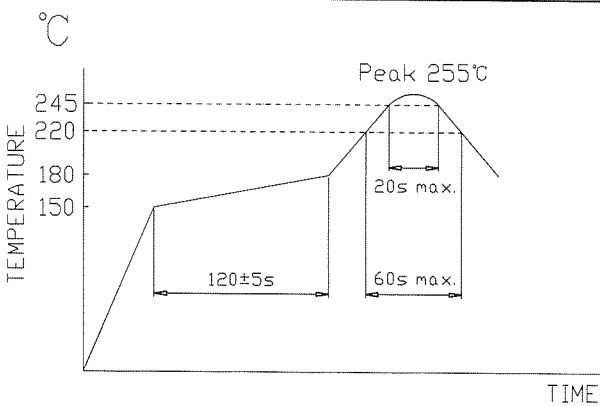
No.	Test Item	Test Method	Requirements
9-4-1	Soldering (Resistance to reflow soldering)	<p>JIS C 60068-2-58 (IEC60068-2-58)</p> <p>1) Solder by setting reflow bath on the following condition.</p> <p>2) Preheating: 150~180°C, 120±5s</p> <p>3) Soldering : 220°C min. 60s max.</p> <p>4) Peak : 245°C min. 20s max. (Peak 255°C max.) (See Diagram A)</p> <p>Note: Temperature must be measured at contact terminal portion and peak temperature on the upper surface of P.C.B must be less than 260°C.</p> <p>5) Solder paste to be used is JIS Z 3282 Sn96.5Ag3.0Cu0.5</p>	<p>1) Contact resistance after the test : Less than 50mΩ</p> <p>2) Insulation resistance after the test : More than 100MΩ</p> <p>3) No short circuit and insulation Breakdown for dielectric withstanding voltage test after this test.</p> <p>4) Free from any damage on performance and contact performance after soldering.</p>
<p><u>Diagram A</u></p>  <p>Resistance to reflow soldering profile</p>			

NUMBER SC-SFW 14	TYPE PRODUCT SPECIFICATION		
TITLE FPC/FFC CONNECTOR (SFW_R-1/2STAE_LF/SFW_R-1/2STGE_LF/SFW_R-1/2STGHE_LF)		PAGE 9 of 11	REVISION G
		AUTHORIZED BY M.YAMASHITA	DATE 24 Nov 09
CLASSIFICATION UNRESTRICTED			

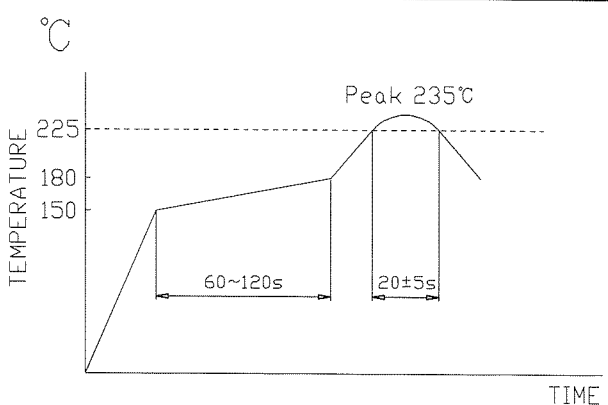
No.	Test Item	Test Method	Requirements
9-4-2	Soldering (Solderability) (Reflow)	<p>JIS C 60068-2-58 (IEC60068-2-58)</p> <p>1) Solder by setting reflow bath on the following condition.</p> <p>2) Preheating: 150~180°C, 60~120s</p> <p>3) Soldering : 225°C min., 20±5s (Peak 235°C max.) (See Diagram B)</p> <p>Note: Temperature must be measured at contact terminal portion and peak temperature on the upper surface of P.C.B must be less than 260°C.</p> <p>4) Solder paste to be used is JIS Z 3282 Sn96.5Ag3.0Cu0.5</p>	1) Actual soldered area must be more than 95% of the dipped area intended to be soldered.
		<p><u>Diagram B</u></p>  <p style="text-align: center;">Solderability profile</p>	
9-4-3	Conductor retention force (Reference)	1) Measure initial retention force after inserted and locked by using accommodated conductor specified in clause 5.	1) More than 0.49N/contact for FPC (More than 50gf/contact for FPC)

NUMBER SC-SFW 14	TYPE PRODUCT SPECIFICATION		
TITLE FPC/FFC CONNECTOR (SFW_R-1/2STAE_LF/SFW_R-1/2STGE_LF/SFW_R-1/2STGHE_LF)		PAGE 10 of 11	REVISION G
		AUTHORIZED BY M.YAMASHITA	DATE 24 Nov 09
CLASSIFICATION UNRESTRICTED			

10. INDICATION AND PACKAGING

10-1. Indication

- 1) Catalog number and lot number are not indicated on the connector.
- 2) Catalog number and quantity shall be indicated on the surface of the package box.

10-2. Packaging

- 1) The connector individuals are packed by tapes with specified quantity in accordance with [JIS C 0806 "Packaging of Electronic Components on Continuous Tapes (Surface Mount components)"] and put into package box in accordance with FCI packaging specification.

11. REMARKS

11-1. Please refer to the "Handling procedures and remarks" before use.

11-2. Retention force for accommodated conductor specified in clause 9-4-3 differs due to its kind, structure and surface treatment of conductor. Therefore, the value of retention force specified in the clause for performance is reference value.

11-3. Please use for Gold plating FPC as accommodated conductor.

12. RECOMMENDED REFLOW PROFILE

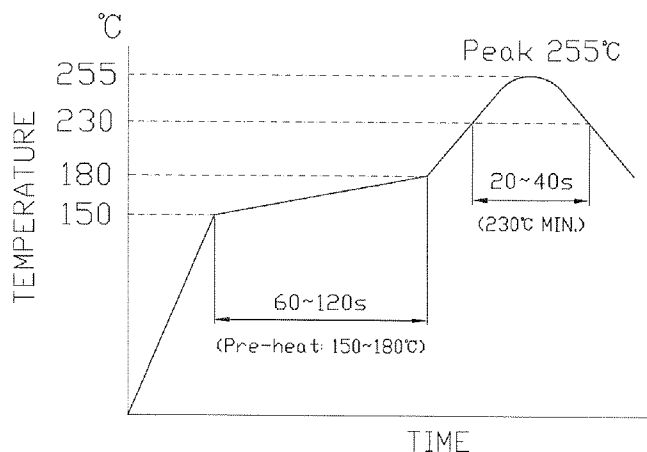



Diagram C. Recommended reflow temperature profile

Note: Please check the reflow soldering condition for your own application beforehand due to different conditions with soldering devices, P.C. Boards, etc.
No moisture treatment before reflow process.

NUMBER SC-SFW 14	TYPE PRODUCT SPECIFICATION		
TITLE FPC/FFC CONNECTOR (SFW_R-1/2STAE_LF/SFW_R-1/2STGE_LF/SFW_R-1/2STGHE_LF)		PAGE 11 of 11	REVISION G
		AUTHORIZED BY M.YAMASHITA	DATE 24 Nov 09
CLASSIFICATION UNRESTRICTED			

13. REVISION RECORD

REV.	PAGE	DESCRIPTION	ECR #	DATE
	All	New release	J03-0421	14 Oct 03
A	All	Add Cat. No.	J04-0437	03 Dec 04
B	All	Spec update	J05-0055	07 Feb 05
C	5	Correct solder operation to slider operation	J06-0080	01 Mar 06
D	All 3	Revise format of product spec. Operating Temperature change from -55°C ~ +85°C to -55°C ~ +105°C	S07-0192	21 Mar 07
E	3 – 6	Revise spec for lead-free solder Add "Diagram A" Resistance to Reflow Soldering Profile. Add "Diagram B" Solderability Profile.	S09-0075	09 Mar 09
F	All	Add Table of contents Add "Diagram C" Recommended Reflow Profile.	J09-0371	16 Oct 09
G	11	Corrected paragraph Number.	J09-0410	24 Nov 09

X-ON Electronics

Largest Supplier of Electrical and Electronic Components

Click to view similar products for [FFC & FPC Connectors](#) category:

Click to view products by [Amphenol](#) manufacturer:

Other Similar products are found below :

[K-FC20](#) [FH29B-80S-0.2SHW\(99\)](#) [FPH-2022G](#) [AYF332735](#) [52610-1075](#) [52610-1275](#) [52610-1934](#) [501864-3091-TR225](#) [086222026001800](#)
[52610-0675](#) [62684-36210E9ALF](#) [52746-1671-TR250](#) [10051922-2810EHLF](#) [6-520415-9](#) [SFV6R-1STE9HLF](#) [XF3M-2915-1B-R100](#)
[1658549-1](#) [46214008010800](#) [AYF534065TA](#) [AYF351525](#) [086212040340800+](#) [AYF530365TA](#) [67000-014LF](#) [67000-004LF](#)
[006207341915000+](#) [DS1020-19RT1D](#) [67000-003LF](#) [67000-011LF](#) [67000-016LF](#) [HFW14R-2STE9LF](#) [SFV32R-2STBE9HLF](#) [SFW12R-](#)
[5STE9LF](#) [SFW18R-1STAE9LF](#) [SFW4R-5STE9LF](#) [52807-0430](#) [046283021002868+](#) [THD1015-8CL-SN](#) [67000-006LF](#) [502250-8027](#)
[104267-9617](#) [66987-011LF](#) [AYF362535](#) [F0501-T-50-20T-R](#) [HFW8S-2STAE1HLF](#) [67000-008LF](#) [67000-012LF](#) [ECC576069EU](#) [F1002-B-](#)
[20-20T-R](#) [HFW15S-2STAE1HLF](#) [5019511030](#)