

Amphenol SOCAPEX

Thermal Clamps Series SIHD GT

Board to Board Interconnect Solutions

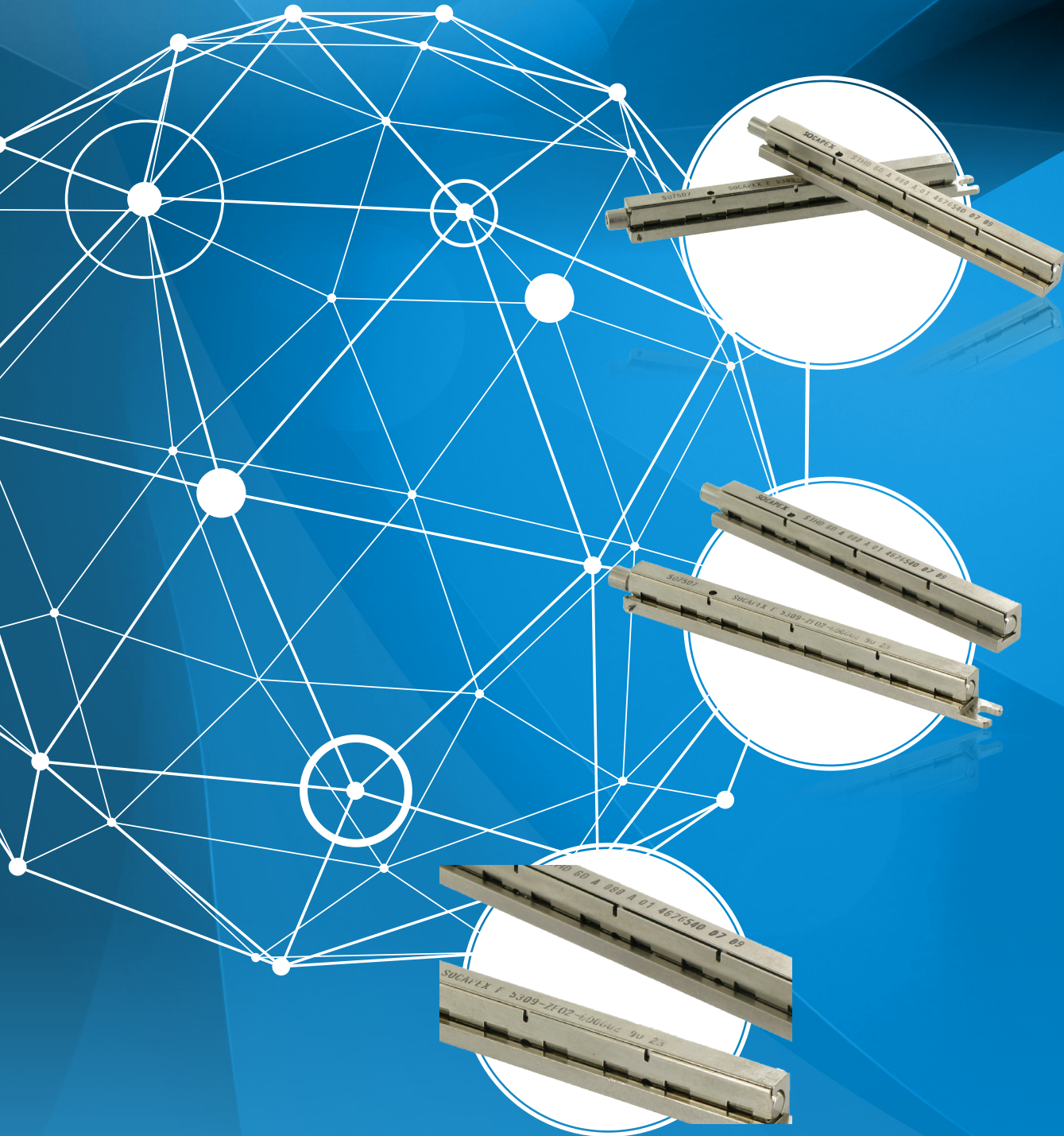

Thermal Clamps

Amphenol Series SIHD GT

MAIN CHARACTERISTICS

MAXIMUM RELIABILITY

- **QUICK LOCKING AND UNLOCKING** : Unlike others on the market, Series SIHD-GT thermal clamps feature a quick, quarter-turn locking mechanism that provides a positive and fast assembly.
- **MAXIMUM RESISTANCE TO SHOCK AND VIBRATION** : Very low wear and resistant to extreme shock and vibration, even when used in harsh environments.
- **NO MOVING PARTS** : The precision assembly permits the three components (body, spring and rod/cam) of the thermal clamp to stay together, even when in the unlocked position.
- **SENSITIVE AND VISUAL INDICATION** : The top end of the rod/cam provides a visual indication that shows the "open" or "closed" position for ease of inspection.

MAXIMUM THERMAL TRANSFER

- **UNIFORM HEAT TRANSFER** : Its unique design produces a uniform pressure distribution along the PCB edge for absolute best heat transfer, which avoids damaging the heat sink and provides a better thermal conduction.
- The uniform clamping pressure eliminates hot spots along the PCB interface producing an even distribution of heat along the entire edge.
- Thermal couple between the cold wall and the heat sink is created by a direct metal to metal contact providing more heat transfer capability than conventional wedge style retainers due to the constant pressure and the flexibility of the spring.
- **ZERO INSERTION AND EXTRACTION FORCES** : The insertion and guiding process of the PCB in its location requires no additional force.
- Board lengths between 80 mm (3.15 in) and 240 mm (9.45 in) can be accommodated once the cold wall and heat sink are specified - in increment of 20 mm (0.787 in).
- Series SIHD-GT thermal clamps are compatible with different heat sinks thicknesses.
- **MAINTAINABILITY** : the unique design makes field repairs quick and easy. Repairs can be accomplished without use of any special tool. Although the SIHD-GT thermal clamps have been tested for over one thousand lock-unlock cycles, they have been derated and specified for 500 fully loaded cycles. This, in most cases, will exceed the overall system life, virtually eliminating service and maintenance.
- Various mounting options are available.
- Other custom styles are available upon request.

AMPHENOL SOCAPEX

948, Promenade de l'Arve

BP 29
74311 THYEZ CEDEX
FRANCE

• +33 450 892 800 •



GENERAL DESCRIPTION

Amphenol offers a new advanced design. Series SIHD-GT thermal clamps are designed to ensure the thermal coupling (heat dissipation) between the heat sink of a printed circuit board and the cold wall of a box (for Daughter Board), or of a backplane (for the Mother Board).

At the same time they ensure the guiding of the boards in its locations, as well as the locking of the Daughter Boards into the right position relative to the Mother Board by a 1/4 turn.

Ease of use, safety in vibration, low weight and space saving are benefits of this design.

Series SIHD-GT thermal clamps are available in the following designs :

- a left type and a right type,
- different platings,
- variety of lengths,
- different locking devices (standard and custom tools).

APPLICATIONS

- Avionic systems
- Submarine equipment
- Ground military vehicles
- Superior retainer for high density electronic devices running in very high vibration environments.
- Designed to comply with MIL-STD-810E.

Technical Characteristics

- Heat sink thickness capability :
 - Standard version : 1.6 mm^{+/-0.15 mm} (0.063 in ^{+/-0.0059 in}) with a minimum of 0.8 mm^{+/-0.15 mm} (0.0315 in ^{+/-0.0059 in})
 - Other versions : by addition of wedges
- Distance between 2 Daughter Boards (mounting pitch) :
 - “to screw” version : from 8 mm min. (0.315 in min.), depending on the connector that it used
 - “to latch” or “to insert” version : from 10.16 mm min. (6.40 in min.)
- Mechanical endurance :
 - 500 locking / unlocking cycles
- Locking of the board (PCB retention) :
 - For the minimum heat sink thickness (1.45 mm or 0.57 in) : > 50 N for a thermal clamp of 80 mm (> 11.25 lbs for a thermal clamp of 3.15 in)
- Maximum locking / unlocking coupling torque : 5 Nm for a thermal clamp of 80 mm (44.3 lbs.in for a thermal clamp of 3.15 in)

Environmental Characteristics

- Temperature range : 1000 hours from -55°C to 125°C
- Temperature shock : 500 cycles (-50°C / +125°C under NFC20605 method A1) and MIL-STD-810E - Method 503.3
- Humidity : 56 days (under NFC20603) and MIL-STD-810E - Method 507.3
- Salt spray : 96 hours (under NFC20611) and MIL-STD-810E - Method 509.3 (Salt Fog 96 hours continuous exposure)
- Sinusoidal vibration : severity 10 Hz to 2000 Hz - 20 gn (under NFC20616) and MIL-STD-810E - Method 514.4
- Random vibration : severity 50 Hz to 2000 Hz - 1.2 gn²/Hz (under MIL-STD-1344 A - Method 2005.1)
- Shock : severity 100 g / 6ms half sine pulse (under NFC20608) and MIL-STD-810E - Method 516.4
- For most applications, the SIHD thermal clamps meet all performance objectives set by military and commercial users for high-reliability, high-density circuit board packaging of electronic equipment.

Material

- Body : Aluminium Alloy (AGS) 6061-T6 QQ-A-200/8
- Spring system : Beryllium Copper (BeCu) per QQ-C-533
- Axis (Rod/Cam) : Stainless Steel per QQ-S-763, ASTM A 582

Finish

- Body and spring system : Nickel plate per QQ-N-290, Class 1, Grade G
- Body : Black Anodise per MIL-A-8625, Type II, Class 2
- Axis (Rod/Cam) : Nickel Passivation per MIL-S-5002

Weight

- Roughly 2,3 g for every 10 mm or 0.206 oz for every inch

Tolerances ... Unless otherwise specified : .xxx = +/- .25 (.010), .xx = +/- .5 (.02)

Note on dimensions ... Metric units listed first followed by english in parenthesis

Specifications subject to change without notice.

Thermal Performance

This varies mainly due to the thermal resistance between the heat sink and the cold wall.

Thickness of the board		Groove e	
mm	(inches)		
1,6	0.063	7,95	0.313
1,2	0.047	7,55	0.297
0,8	0.031	7,15	0.282

e : recommended gap dimension for maximum efficiency

The measure of this resistance depends on three main factors :

- the heat sink
- the thermal clamp
- the cold wall which must pull the heat from the heatsink through conduction

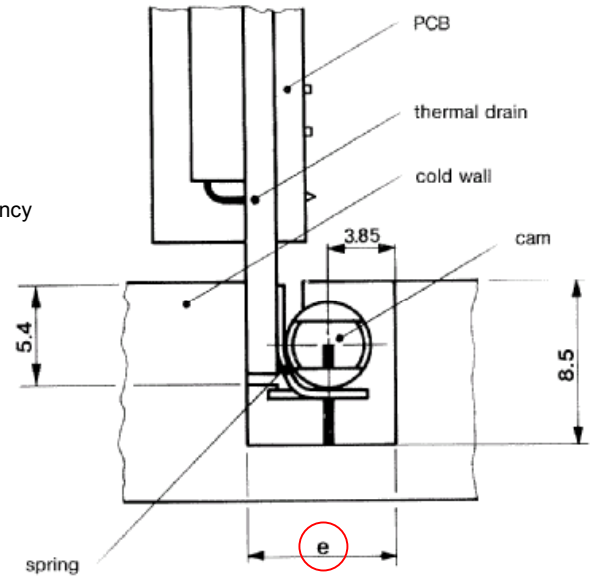

This measure does not take into account the convection and the radiation phenomena, but allows the determination of the thermal resistance of the clamp coupling, for which the values are dependant on the length of the thermal clamp.

The thermal resistance of coupling per surface is less or equal to 1,6 K.W⁻¹.cm² or 2.5°C.inch/Watt.

Amphenol Thermal Clamps - Thermal Resistance Data

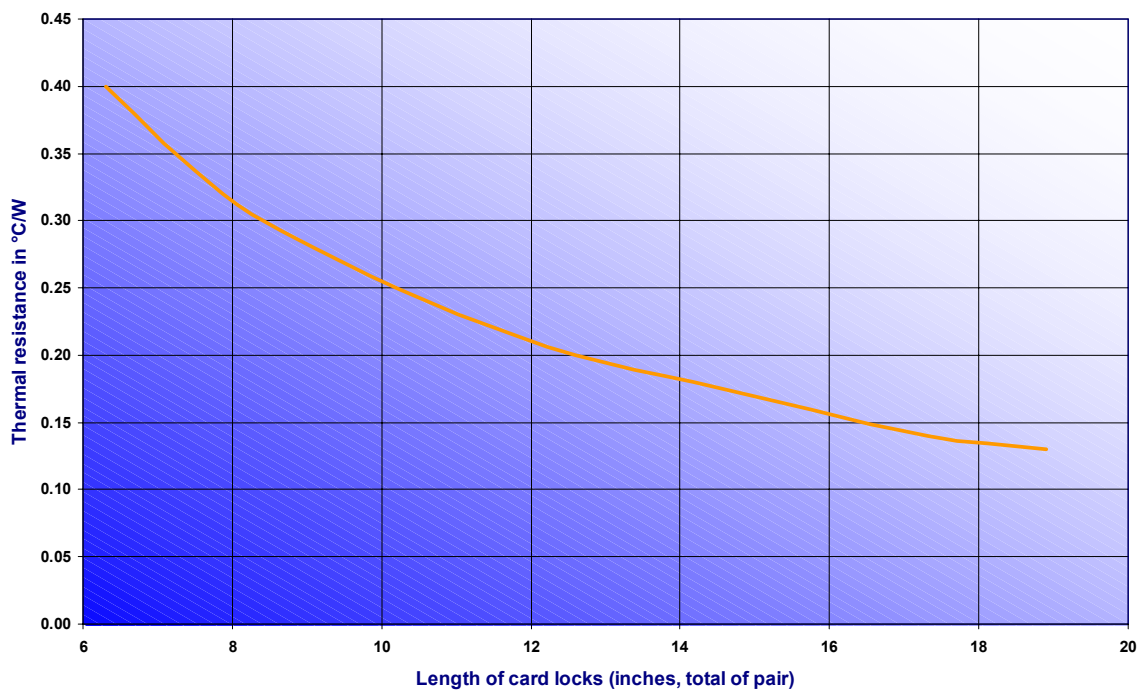

Mechanical Performance

Clamping force applied onto the heat sink for a thermal clamp of 80 mm (3.15 in) :

Thickness of the board in mm	1,45	1,55	1,60	1,65	1,75
<i>Thickness of the board in inches</i>	<i>(0.057)</i>	<i>(0.061)</i>	<i>(0.063)</i>	<i>(0.065)</i>	<i>(0.069)</i>
Average value in N	250	380	460	520	630
<i>Average value in lbs</i>	<i>(56.25)</i>	<i>(85.50)</i>	<i>(103.50)</i>	<i>(117.00)</i>	<i>(141.75)</i>

Clamping efficiency

The efficiency of Amphenol Thermal Clamps has been shown during tests performed on different types of PCB's fitted with thermal drains.

The test results are given as an example in the table below. They cover the following PCB's :

- 200 µm epoxy glass PCB
- thermal drain in CIC (Cu/Invar/Cu)

These comparative tests have been done with a 1/2 ATR PCB equipped with SMT chips. Results show that with identical power, heating is 50 % lower for Amphenol Thermal Clamps inserted in a water cooled rack.

Test Results	Without thermal clamp	With thermal clamp
water flow	-	0.5 l/mm
total dissipated power	12.8 W	12.8 W
room temperature	20.4 ° C	24.2 ° C
water temperature	-	24.2 ° C
average heating	42 ° C	18.6 ° C
maximum heating	45.4 ° C	23.8 ° C
minimum heating	37.6 ° C	14.5 ° C

Test without thermal clamps	Test with thermal clamps
PCB technology : Cu - Inv. - Cu	PCB technology : Cu - Inv. - Cu
total dissipated power : 12,8 W average heating : 42° C	total dissipated power : 12,8 W average heating : 18,6° C

Performance data is for information use only. Manufacturing variability, test conditions, and environmental conditions may affect results.

Test reports

Comprehensive test data has been accumulated during the development of the SIHD-GT thermal clamps to support the performance claims. Thermal and retention performance characteristics are fully documented. The following Amphenol laboratory test procedures, reports and results are available upon request :

- 1 - thermal performance testing
- 2 - shock testing
- 3 - vibration testing
- 4 - life cycling

Engineers who specify the SIHD-GT thermal clamps can have complete confidence in the performance characteristics described.

Quarter turn mechanism

Locking and unlocking directions must be carefully followed - no torque wrench required.

The locking and unlocking direction is different for a left and a right SIHD-GT thermal clamp as shown :

- Locking of a left thermal clamp : counter clockwise
- Locking of a right thermal clamp : clockwise

With the help of the color band (at the ultimate extremity of the axis), the user can identify if the boards are locked or not in to place.

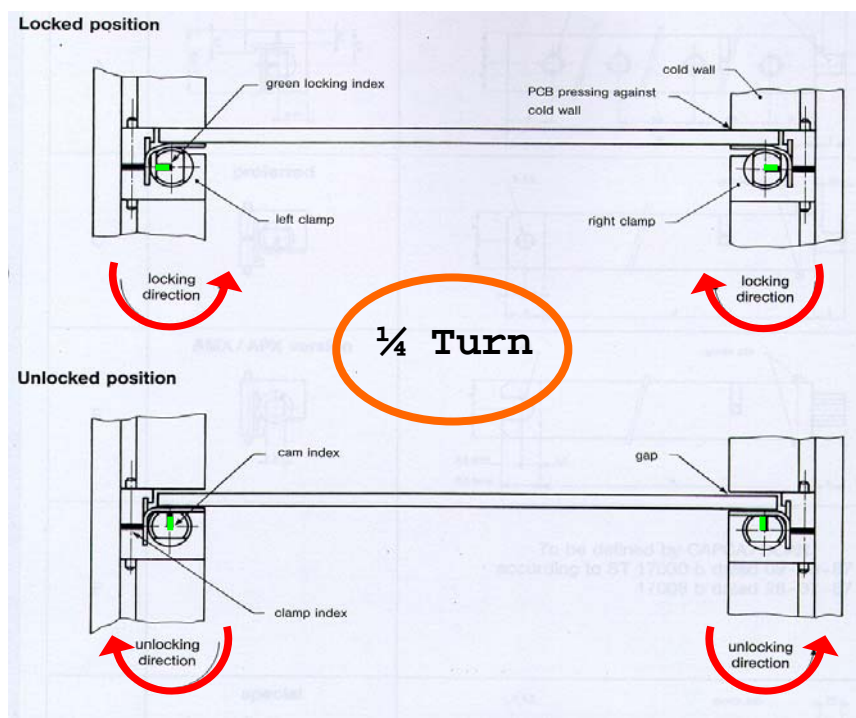

Locking / Unlocking Tools

Wrench for axis termination with two flats :
Allen wrench (2 mm - 5/64) :

SIHDGTCLE
SIHDGTCRE

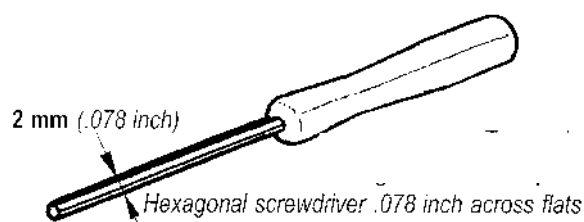
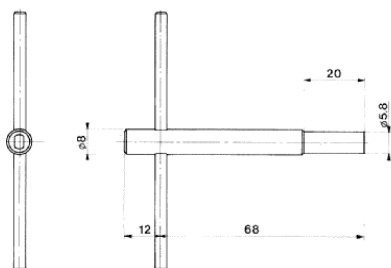

SIHD Thermal Clamp range

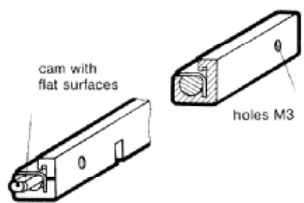
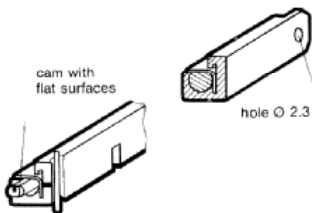
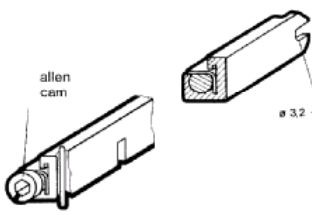
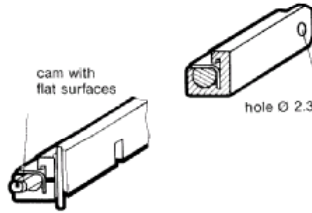
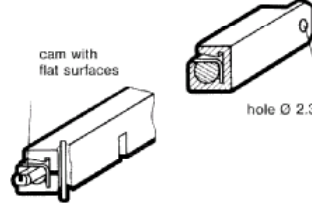
Clamp version	Type	Use
 <p>cam with flat surfaces holes M3</p>	A	Cam with flat surfaces with screw fixing
 <p>cam with flat surfaces hole Ø 2.3</p>	C	Cam with flat surfaces Front : latch fixing Rear : screw fixing for 1/2 ATR PCB 80 mm long PREFERRED
 <p>allen cam ø 3.2</p>	E	AMX - APX Ground forces standard version Allen cam 80 mm long
<p>To be defined by CAPCA / DCAN according to S.T. 17030 b dated 9.10.87 S.T. 17008 b dated 28.07.87</p>	F	
 <p>cam with flat surfaces hole Ø 2.3</p>	T	Cam with flat surfaces Front : latch fixing Rear : screw fixing 89 mm long SPECIAL
 <p>cam with flat surfaces hole Ø 2.3</p>	R	Cam with flat surfaces Front : latch fixing Rear : screw fixing Special profile 169 mm long For double -Europe PCB SPECIAL

Outline dimension

Type	Viewed from right	Front view
A		
C	<p>preferred</p>	
E	<p>AMX / APX version</p>	
F		<p>To be defined by CAPCA / DCAN according to ST 17030 b dated 09-10-87 17008 b dated 28-07-87</p>
T	<p>special</p>	
R	<p>special</p>	

Dimensions

	Length of thermal clamps											
a (mm)	60	80	89	100	120	140	160	169	180	200	220	240
a (in)	2.36	3.15	3.50	3.94	4.72	5.51	6.30	6.65	7.09	7.87	8.66	9.45
b (mm)		28		48	28	48	28		48	28	48	28
b (in)		1.10		1.89	1.10	1.89	1.10		1.89	1.10	1.89	1.10
F (mm)	6.2	6.2	6.2	6.2	6.2	6.2	6.2	7	7	7	7	7
F (in)	0.244	0.244	0.244	0.244	0.244	0.244	0.244	0.276	0.276	0.276	0.276	0.276
m (mm)	4	4	4	4	4	4	4	4	6.5	6.5	6.5	6.5
m (in)	0.157	0.157	0.157	0.157	0.157	0.157	0.157	0.157	0.256	0.256	0.256	0.256
n (mm)	1	1		1	2	2	3		3	4	4	5
n (in)	0.039	0.039		0.039	0.079	0.079	0.118		0.118	0.157	0.157	0.197

	PCB thickness		
	1.6	1.2	0.8
	0.063	0.047	0.031
c (mm)	8	7.6	7.2
c (in)	0.315	0.299	0.283
d (mm)	4	3.6	3.2
d (in)	0.157	0.142	0.126
e (mm)	7.95	7.55	7.15
e (in)	0.313	0.297	0.281

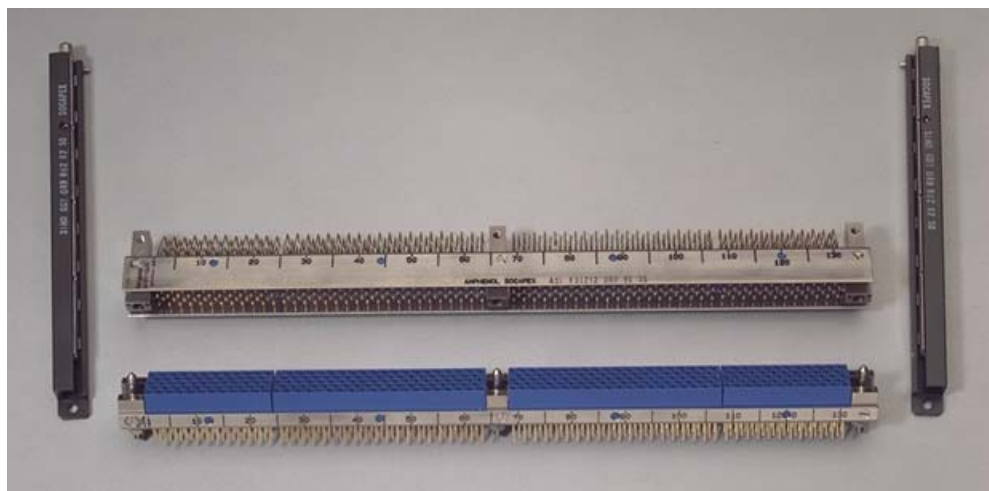

Rack machining : "A" type *(please consult Amphenol for other types)*

Left thermal clamp Thermal extraction via end of rack	Right thermal clamp Thermal extraction via end of rack
symmetrically	

Left thermal clamp Thermal extraction via lateral wall	Right thermal clamp Thermal extraction via lateral wall
symmetrically	

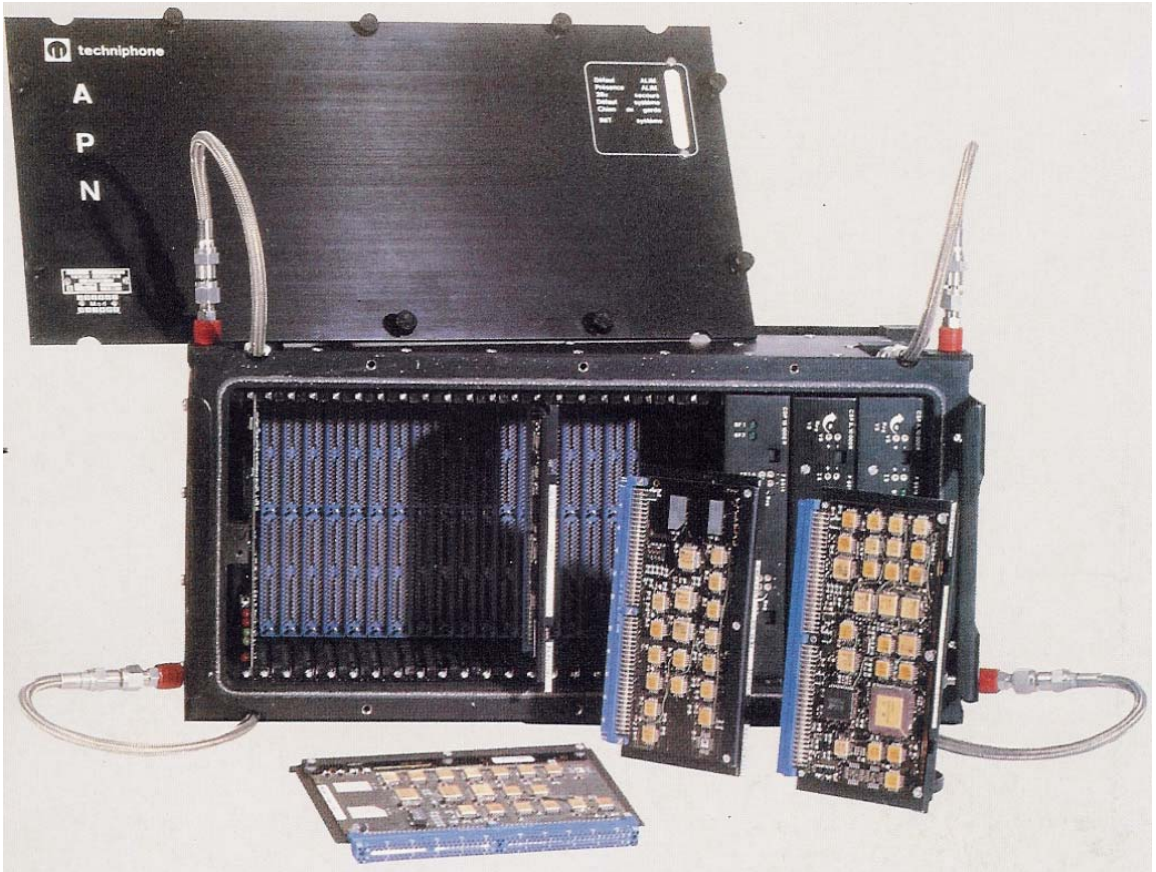

Part Number Code

Series : Thermal Clamp	SIHD	G	D	A	80	A	01	-
Side of equipment : Left : G Right : D								
Version : A : screw fixing C : front (latch fixing) and rear (screw fixing) - Cam with flat surface E : Allen cam (AMX-APX) ground forces, standard 80 mm long								
Length : In mm, every 20 mm - 0.79 in incremental min. 80 mm (3.15 in) to a max. 240 mm (9.45 in) for version A, C and F min. 89 mm (3.50 in) for version T min. 169 mm (6.65 in) for version R								
Thickness of PCB drain : A : 1.6 mm (0.063 in) preferred B : 1.2 mm (0.047 in) C : 0.8 mm (0.031 in) except R version								
Finish : 01 : conductive chemical Ni plating 02 : black anodised								
Deviation : Blank for normal FXXX (to customer specifications)								

† Additional and specific designs available : please consult Amphenol.

Technical Assistance

Our engineering team has extensive experience in the packaging of thermal clamps. Modification of standard thermal clamps for special application is possible. If more information is needed concerning the products in this publication, or if you have any special application needs, please contact your nearest Amphenol Sales Office or Amphenol Corporation at the following address:

AMPHENOL CORPORATION
Amphenol Socapex
948 Promenade de l'Arve
BP 29
74311 THYEZ - FRANCE
Telephone : + 33 450 892 800
Fax : + 33 450 962 975
www.amphenol-socapex.com

We welcome the opportunity of providing you with the assistance needed to solve your thermal management problems.

AMPHENOL SOCAPEX
948, Promenade de l'Arve
BP 29
74311 THYEZ CEDEX
FRANCE

Amphenol®

© 2002 Copyright. Printed in France
Amphenol Socapex -Ref. SIHD-GT2002-04DS(draft)

X-ON Electronics

Largest Supplier of Electrical and Electronic Components

Click to view similar products for [Rectangular MIL Spec Connectors](#) category:

Click to view products by [Amphenol](#) manufacturer:

Other Similar products are found below :

[891-011-15SA2-BSST](#) [CTS-S16/16](#) [65002-062](#) [CY4602-000](#) [732-8020-01](#) [77058-22-55PN](#) [81542-20](#) [86.030.0053.0](#) [1241346-1](#) [RM252-020-311-2900](#) [DMC-M 08-16 SA](#) [1589051-4](#) [MSO34MPK1E1](#) [BACC65CAMA](#) [BACC65CP1PN](#) [BACI10BC0816PNBA](#) [HSB-D4S03DM222X](#) [2217548-1](#) [891-006-9PS-BST1T](#) [891-009-15SA2-BRT1T](#) [27963-20T12](#) [SIM2S100A](#) [1604996-2](#) [SMD25PN90L-4055](#) [1900ND08S1B00A](#) [22628-10-6P-791](#) [33526M11-08PD](#) [RE04-212S](#) [M32139/03-G05SN](#) [CTD160E01F-6148](#) [CTJ112E03B](#) [CTJ122E02D-8000](#) [CTJ-3D-12](#) [CTJ920E06N-513](#) [CTJ920E12N-513](#) [CTL-16-090](#) [RM300-000-581-0000](#) [CY4600-000](#) [CY4601-000](#) [38111-14-15SN](#) [38112-14-15PN](#) [MMA23-0111R1](#) [MMD25-0071P1](#) [33516062020](#) [33526M11-08PE](#) [DMC-M99-01AN](#) [Y59113WE20PNV00300](#) [ZPF000000000106310](#) [105979-31](#) [EN4165M01AD0G0](#)