

Socket Junction Systems

MIL-T-81714 Series II, Class D



MIL-T-81714 Series II Junction Modules

The high pin count, low weight MIL-T-81714 Series II Socket Junction Module System is available in four basic module sizes, accommodating 12-26 AWG wire in a broad selection of bussing arrangements. Modules are supplied with the appropriate and specified MIL-C-39029/22 socket contacts.



Feedback Modules
Feedthru Modules
Distribution Modules



Board Mount Modules



Ground Modules



Sealed Splices



Mounting Tracks

Key Features and Benefits

Improved Performance

Significant Amphenol Pcd design innovations over conventional Series II systems assure superior performance in wire sealing, contact alignment and retention, and module extraction.

Feedback Modules

The SJM feedback modules and mounting track system offer a lightweight junction system with a full range of bussing arrangements.

Distribution Modules

Distribution modules provide a variety of contact combinations for power distribution applications and have the same construction and features as the standard Series II modules.

Ground Modules

SJM grounding modules are available in both center stud and mounting flange versions.

Board Mount Pin Modules

The socket junction modules indicate on the following pages can also be provided in a solder pin version for mounting directly to printed circuit boards, providing a flexible, compact wiring package and eliminating the need for mounting track.

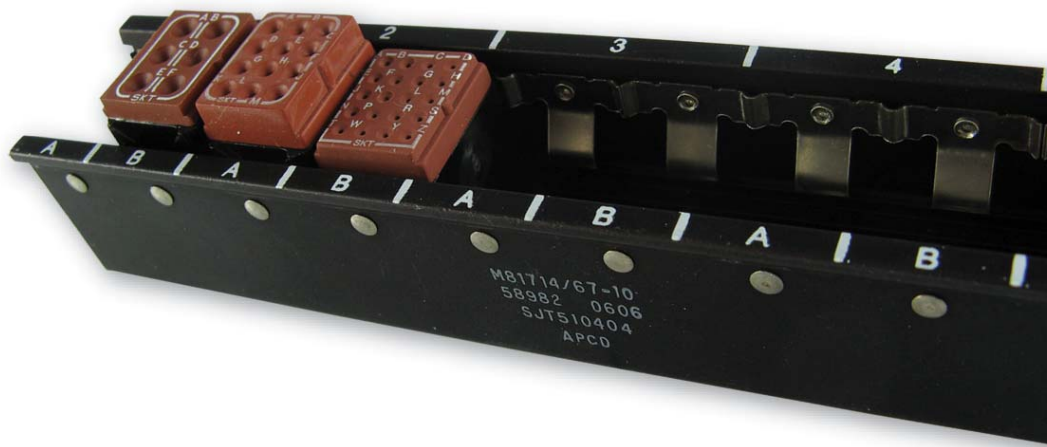

Military Qualified, QPL-Listed MIL-T-81714 Series II, Class D

Socket Junction Modules

Military P/N	Amphenol Pcd P/N	Page
M81714/60-22-01	SJM022100	49
M81714/60-22-02	SJM022200	49
M81714/60-22-04	SJM022400	49
M81714/60-22-05	SJM022500	49
M81714/60-22-06	SJM022600	49
M81714/60-22-10	SJM022700	49
M81714/60-20-01	SJM020100	50
M81714/60-20-02	SJM020200	50
M81714/60-20-03	SJM020300	50
M81714/60-20-04	SJM020400	50
M81714/60-20-06	SJM020600	50
M81714/60-16-01	SJM016100	51
M81714/60-16-02	SJM016200	51
M81714/60-16-03	SJM016300	51
		51
M81714/60-12-01	SJM012100	51
M81714/60-12-02	SJM012200	51
M81714/60-12-03	SJM012300	51
M81714/61-0Z	SJM000100	52
M81714/61-0Y	SJM000800	52
M81714/61-0X	SJM000200	52
M81714/61-0W	SJM000300	52

Socket Grounding Modules

Military P/N	Amphenol Pcd P/N	Page
M81714/63-22S	SJG022170	54
M81714/63-20S	SJG020170	54
M81714/63-16S	SJG016170	54
M81714/63-22F	SJG022270	55
M81714/63-20F	SJG020270	55
M81714/63-16F	SJG016270	55
M81714/63-12F	SJG016270	55

Socket Junction Module Mounting Track

Military P/N	Amphenol Pcd P/N	Page
M81714/67-02	SJT502404	59
M81714/67-03	SJT503404	59
M81714/67-04	SJT504404	59
M81714/67-05	SJT505404	59
M81714/67-06	SJT506404	59
M81714/67-07	SJT507404	59
M81714/67-08	SJT508404	59
M81714/67-09	SJT509404	59
M81714/67-10	SJT510404	59
M81714/67-12	SJT512404	59
M81714/67-13	SJT513404	59
M81714/67-14	SJT514404	59
M81714/67-15	SJT515404	59
M81714/67-16	SJT516404	59
M81714/67-18	SJT518404	59
M81714/67-19	SJT519404	59
M81714/67-20	SJT520404	59
M81714/67-21	SJT521404	59
M81714/67-25	SJT525404	59
M81714/67-30	SJT530404	59
M81714/67-32	SJT532404	59
M81714/67-40	SJT540404	59

In-Line Junction Splices

Military P/N	Amphenol Pcd P/N	Page
M81714/65-16-1	SJS316700	58
M81714/65-20-1	SJS320700	58
M81714/65-22-1	SJS322700	58
M81714/65-16-2	SJS316701	58
M81714/65-20-2	SJS320701	58
M81714/65-22-2	SJS322701	58

M81714/60-22

Series II Size 22

Operating Range

Temperature:

-65°C to 200°C

Insulation Resistance:

5000 Megaohms @ 25°C

Dielectric Withstanding Voltage:

1500 VRMS at Sea Level

200 VRMS at 110,000 ft.

Current Rating

5 Amps

Vibration & Shock:

MIL-T-81714 Paragraph

3.5.5 and 3.5.8

Materials

Module Body:

Polytherimide per ASTM-D5205

Grommet:

Silicone Blend Elastomer per A-A-59588

Contact Retainers:

Stainless Steel

Internal Pin and Socket Contacts:

Copper Alloy, Hard Gold Plated in

Accordance with MIL-G-45204

Socket Junction Modules



Amphenol Pcd Socket Junction Modules

Bussing Configurations	Part Numbers		Contact		
	Military P/N	APCD P/N	QTY*	Size ¹	P/N M39029
	M81714/60-22-01	SJM022100	20	22/22	/22-191
	M81714/60-22-02	SJM022200	20	22/22	/22-191
	M81714/60-22-04	SJM022400	20	22/22	/22-191
	M81714/60-22-05	SJM022500	20	22/22	/22-191
	M81714/60-22-06	SJM022600	20	22/22	/22-191
	M81714/60-22-07	SJM022700	20	22/22	/22-191

* Quantity figure denotes number of contacts accommodated by module. Modules are supplied with one additional spare contacts and two sealing plugs.

¹ Mating End / Wire Barrel.

Socket Junction Module Dimensions

Front & Side View

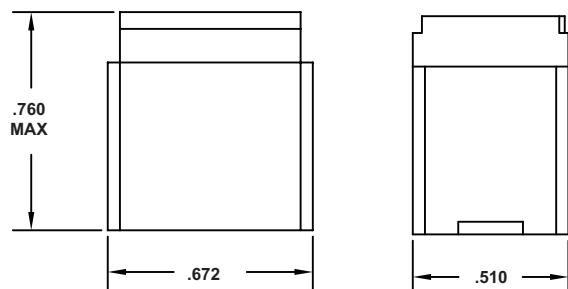

Top View

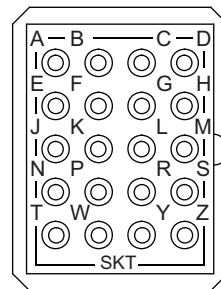

M81714/60-22-01 SHOWN



Amphenol Pcd

Socket Junction Modules

M81714/60-20

Series II Size 20



Operating Range

Temperature:

-65°C to 200°C

Insulation Resistance:

5000 Megaohms @ 25°C

Dielectric Withstanding Voltage:

1500 VRMS at Sea Level

200 VRMS at 110,000 ft.

Current Rating

7.5 Amps

Vibration & Shock:

MIL-T-81714 Paragraph

3.5.5 and 3.5.8

Materials

Module Body:

Polyetherimide per ASTM-D5205

Grommet:

Silicone Blend Elastomer per A-A-59588

Contact Retainers:

Stainless Steel

Internal Pin and Socket Contacts:

Copper Alloy, Hard Gold Plated in

Accordance with MIL-G-45204

Amphenol Pcd Socket Junction Modules

Bussing Configurations	Part Numbers		Contact		
	Military P/N	APCD P/N	QTY*	Size ¹	P/N M39029
	M81714/60-20-01	SJM020100	12	20/20	/22-192
	M81714/60-20-02	SJM020200	12	20/20	/22-192
	M81714/60-20-03	SJM020300	12	20/20	/22-192
	M81714/60-20-04	SJM020400	12	20/20	/22-192
	M81714/60-20-06	SJM020600	12	20/20	/22-192

* Quantity figure denotes number of contacts accommodated by module. Modules are supplied with one additional spare contacts and two sealing plugs.

¹ Mating End / Wire Barrel.



Socket Junction Module Dimensions

Front & Side View

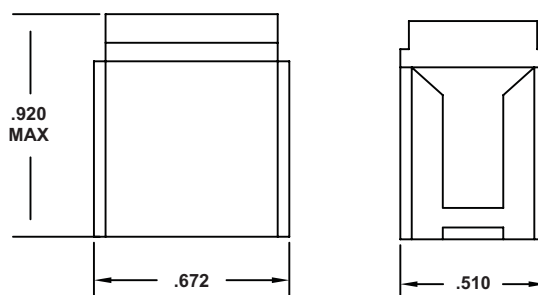

Top View

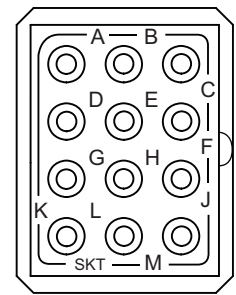

M81714/60-20-01 SHOWN

M81714/60-16

Series II Size 16

Operating Range

Temperature:
-65°C to 200°C

Insulation Resistance:
5000 Megohms @ 25°C

Dielectric Withstanding Voltage:
1500 VRMS at Sea Level
200 VRMS at 110,000 ft.

Current Rating
13 Amps

Vibration & Shock:
MIL-T-81714 Paragraph
3.5.5 and 3.5.8

Materials

Module Body:
Polyetherimide per ASTM-D5205

Grommet:
Silicone Blend Elastomer per A-A-59588

Contact Retainers:
Stainless Steel

Internal Pin and Socket Contacts:
Copper Alloy, Hard Gold Plated in
Accordance with MIL-G-45204

Socket Junction Modules



Amphenol Pcd Socket Junction Modules

Bussing Configurations	Part Numbers		Contact		
	Military P/N	APCD P/N	QTY*	Size ¹	P/N M39029
	M81714/60-16-01	SJM016100	6	16/16	/22-193
	M81714/60-16-02	SJM016200	6	16/16	/22-193
	M81714/60-16-03	SJM016300	6	16/16	/22-193

* Quantity figure denotes number of contacts accommodated by module. Modules are supplied with one additional spare contacts and two sealing plugs.

¹ Mating End / Wire Barrel.

Socket Junction Module Dimensions

Front & Side View

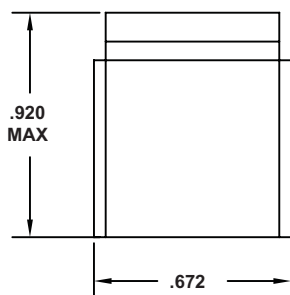

Top View

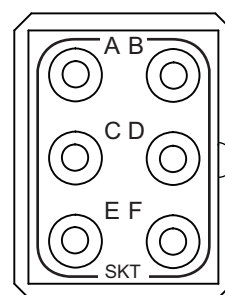

M81714/60-16-01 SHOWN



Amphenol Pcd

Socket Junction Modules

M81714/60-12

Series II Size 12



Operating Range

Temperature:

-65°C to 200°C

Insulation Resistance:

5000 Megaohms @ 25°C

Dielectric Withstanding Voltage:

1500 VRMS at Sea Level

200 VRMS at 110,000 ft.

Current Rating

23 Amps

Vibration & Shock:

MIL-T-81714 Paragraph

3.5.5 and 3.5.8

Materials

Module Body:

Polyetherimide per ASTM-D5205

Grommet:

Silicone Blend Elastomer per A-A-59588

Contact Retainers:

Stainless Steel

Internal Pin and Socket Contacts:

Copper Alloy, Hard Gold Plated in

Accordance with MIL-G-45204

Amphenol Pcd Socket Junction Modules

Bussing Configurations	Part Numbers		Contact		
	Military P/N	APCD P/N	QTY*	Size ¹	P/N M39029
	M81714/60-12-01	SJM012100	6	12/12	/22-605
	M81714/60-12-02	SJM012200	6	12/12	/22-605
	M81714/60-12-03	SJM012300	6	12/12	/22-605

* Quantity figure denotes number of contacts accommodated by module. Modules are supplied with one additional spare contacts and two sealing plugs.

¹ Mating End / Wire Barrel.



Socket Junction Module Dimensions

Front & Side View

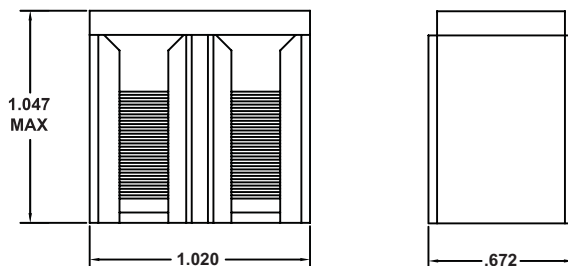

Top View

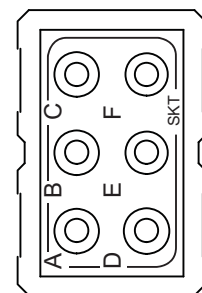

M81714/60-12-01 SHOWN

M81714/61 Series II

Distribution Socket Junction Modules

Socket Junction Modules

Operating Range

Temperature:
-65°C to 200°C

Insulation Resistance:
5000 Megaohms @ 25°C

Dielectric Withstanding Voltage:
1500 VRMS at Sea Level
200 VRMS at 110,000 ft.

Current Rating
5 Amps (Size 22)
7.5 Amps (Size 20)
13 Amps (Size 16)
23 Amps (Size 12)

Vibration & Shock:
MIL-T-81714 Paragraph
3.5.5 and 3.5.8

Materials

Module Body:
Polyetherimide per ASTM-D5205

Grommet:
Silicone Blend Elastomer per A-A-59588

Contact Retainers:
Stainless Steel

Internal Pin and Socket Contacts:
Copper Alloy, Hard Gold Plated in
Accordance with MIL-G-45204



Amphenol Pcd Socket Junction Modules

Bussing Configurations	Part Numbers		Contact			Bussing
	Military P/N	APCD P/N	QTY	Size	P/N M39029	Bus Description
	M81714/61-0Z	SJM000100	6	16	/22-193	1 BUS TWO SIZE 12 & SIX SIZE 16
			2	12	/22-605	
	M81714/61-0Y	SJM000800	6	20	/22-192	1 BUS TWO SIZE 16 & SIX SIZE 20
			2	16	/22-193	
	M81714/61-0X	SJM000200	6	16	/22-193	2 BUSSES ONE SIZE 12 & THREE SIZE 16 PER BUS
			2	12	/22-605	
	M81714/61-0W	SJM000500	5	22	/22-191	5 BUSSES ONE SIZE 22 & ONE SIZE 20 & ONE SIZE 16 PER BUS
			5	20	/22-192	
			5	16	/22-193	

Socket Junction Module Dimensions

Front View

M81714/61-0Y

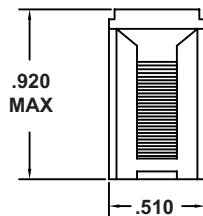

M81714/61-0Z, M81714/61-0X, M81714/61-0W

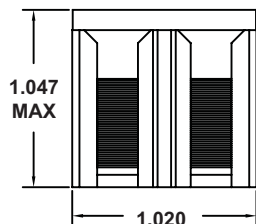

Side View

M81714/61-0Y

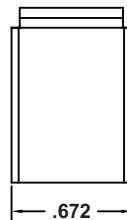

M81714/61-0Z, M81714/61-0X, M81714/61-0W

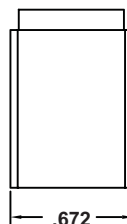

Product Description

Distribution Socket Junction Modules are available in a variety of MIL-T-81714 configurations, feature the same construction and features as the standard Series II high density modules, and are recommended for power distribution applications



Amphenol Pcd

M81714/63 Socket Ground Modules

Stud Mount Series II Size 16, 20, 22

Socket Junction Modules



Operating Range

Temperature:
-65°C to 200°C

Current Rating
5 Amps (Size 22)
7.5 Amps (Size 20)
13 Amps (Size 16)

Vibration & Shock:
MIL-T-81714 Paragraph
3.5.5 and 3.5.8

Materials

Module Body:
Polyetherimide per ASTM-D5205

Grommet:
Silicone Blend Elastomer per A-A-59588

Stud / Shell:
Copper Alloy, Gold Plated per
SAE-AMS-2422. Tin Plating per
ASTM-B545 Also Available as an Alternate

Contact Retainers:
Stainless Steel

Socket Contacts:
Copper Alloy, Hard Gold Plated in
Accordance with MIL-G-45204

Socket Grounding Modules Part Numbers

Product Description

M81714/63, stud mount, socket grounding modules mount directly to a ground plane or ground lug creating a multi-wire sealed grounding device. The grounding modules could also be mounted to a bus bar for power distribution, sensing or metering. All mounting hardware is furnished and custom hardware configurations are available. The mounting stud is available in gold or tin plating.

Part Numbers

Contact

Stud

Military P/N	APCD P/N	QTY*	Size ¹	P/N M39029	Plating
M81714/63-22S	SJG022170	20	22/22	/22-191	Gold
	SJG022100	20	22/22	/22-191	Tin
M81714/63-20S	SJG020170	12	20/20	/22-192	Gold
	SJG020100	12	20/20	/22-192	Tin
M81714/63-16S	SJG016170	6	16/16	/22-193	Gold
	SJG016100	6	16/16	/22-193	Tin

* Quantity figure denotes number of contacts accommodated by module. Modules are supplied with one additional spare contacts and two sealing plugs
¹ Mating End/ Wire Barrel

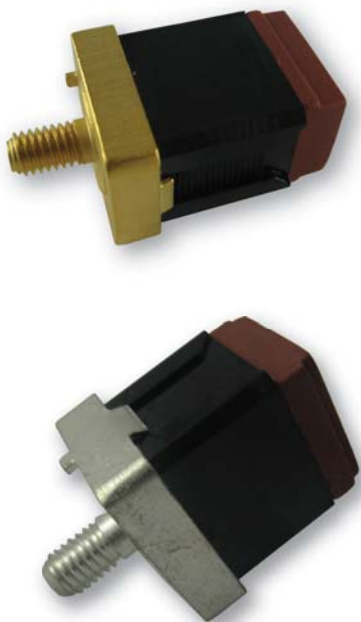

Socket Junction Module Dimensions

Top View

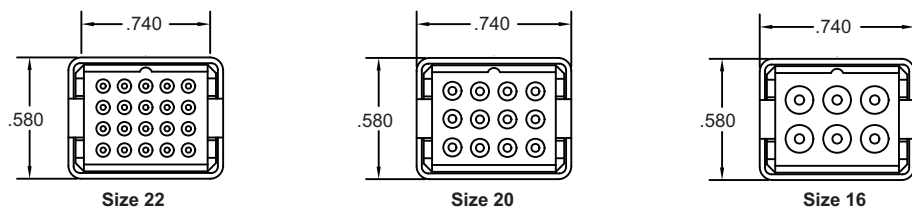

Side View

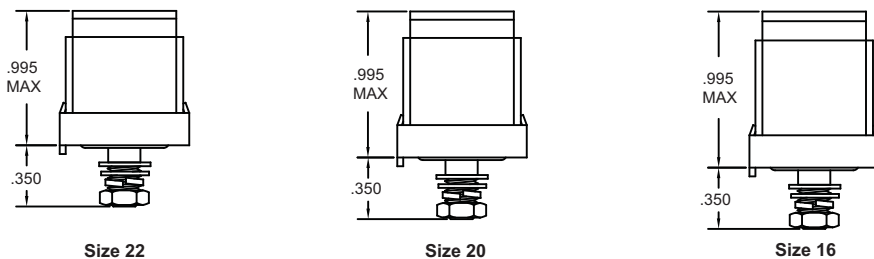

M81714/63 Socket Ground Modules

Flange Mount Series II Size 12, 16, 20, 22

Operating Range

Temperature:

-65°C to 200°C

Current Rating

5 Amps (Size 22)

7.5 Amps (Size 20)

13 Amps (Size 16)

23 Amps (Size 12)

Vibration & Shock:

MIL-T-81714 Paragraph

3.5.5 and 3.5.8

Materials

Module Body:

Polyetherimide per ASTM-D5205

Grommet:

Silicone Blend Elastomer per A-A-59588

Flange / Shell:

Copper Alloy, Gold Plated per SAE-AMS-2422. Tin Plating per ASTM-B545 Also Available as an Alternate

Contact Retainers:

Stainless Steel

Socket Contacts:

Copper Alloy, Hard Gold Plated in Accordance with MIL-G-45204

Socket Junction Modules



Socket Grounding Modules Part Numbers

Part Numbers			Contact		Flange
Military P/N	APCD P/N	QTY*	Size ¹	P/N M39029	Plating
M81714/63-22F	SJG022270	20	22/22	/22-191	Gold
	SJG022200	20	22/22	/22-191	Tin
M81714/63-20F	SJG020270	12	20/20	/22-192	Gold
	SJG020200	12	20/20	/22-192	Tin
M81714/63-16F	SJG016270	6	16/16	/22-193	Gold
	SJG016200	6	16/16	/22-193	Tin
M81714/63-12F	SJG012270	6	12/12	/22-605	Gold
	SJG012200	6	12/12	/22-605	Tin

* Quantity figure denotes number of contacts accommodated by module. Modules are supplied with one additional spare contacts and two sealing plugs
¹ Mating End/ Wire Barrel

Product Description

M81714/ 63, flange mount, socket grounding modules mount directly to a ground plane or ground lug creating a multi-wire sealed grounding device. The grounding modules could also be mounted to a bus bar for power distribution, sensing or metering. All mounting hardware is furnished and custom hardware configurations are available. The mounting stud is available in gold or tin plating.

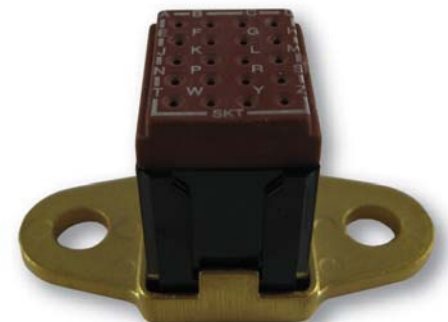
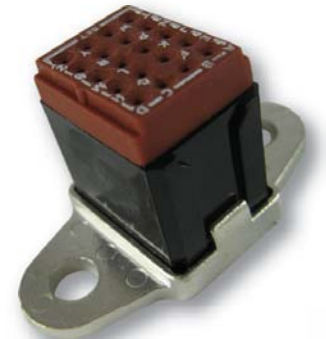

Socket Junction Module Dimensions

Top View

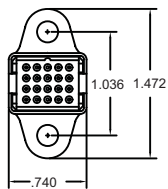

Size 22

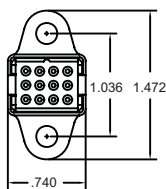

Size 20

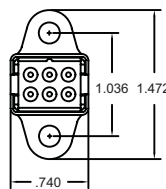

Size 16

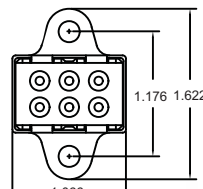

Size 12

Side View

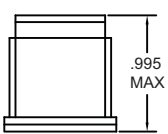

Size 22

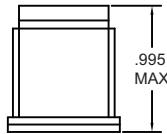

Size 20



Size 16

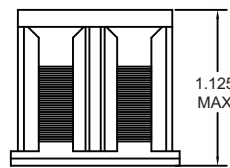

Size 12

Amphenol Pcd

Socket Junction Modules



Board Mount Socket Junction Modules Series II Size 12, 16, 20, 22

Operating Range

Temperature:

-65°C to 125°C

Insulation Resistance:

1000 Megaohms Min.

Dielectric Withstanding Voltage:

1500 VRMS at Sea Level

200 VRMS at 80,000 ft.

Current rating:

5 Amps (Size 22)

7.5 Amps (Size 20)

13 Amps (Size 16)

23 Amps (Size 12)

Materials

Module Body:

Polytherimide per ASTM-D5205

Grommet:

Silicone Blend Elastomer per A-A-59588

Contact Retainers:

Stainless Steel

Socket Contacts:

Copper Alloy, Hard Gold Plated in

Accordance with MIL-G-45204

Product Description

The socket junction modules indicate on the following pages can also be provided in a solder pin version for mounting directly to printed circuit boards, providing a flexible, compact wiring package and eliminating the need for mounting track. Please contact Amphenol Pcd for details on the SJP pin module.

Module Configurations

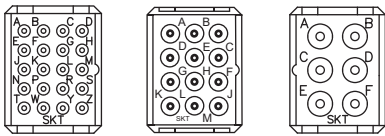

A

B

C



Board Mount Socket Junctions

APCD P/N	QTY	Size	Contact P/N	Config.	DIM. L
SJP022000	20	22/22	M39029/22-191	A	.187
SJP022010	20	22/22	M39029/22-191	A	.250
SJP020000	12	20/20	M39029/22-192	B	.187
SJP020010	12	20/20	M39029/22-192	B	.250
SJP016000	6	16/16	M39029/22-193	C	.187
SJP016010	6	16/16	M39029/22-193	C	.250
SJP012000	6	12/12	M39029/22-605	D	.187
SJP012010	6	12/12	M39029/22-605	D	.250
SJP012010	6	12/12	M39029/22-605	D	.335

Board Mount Socket Junction Modules Dimensions

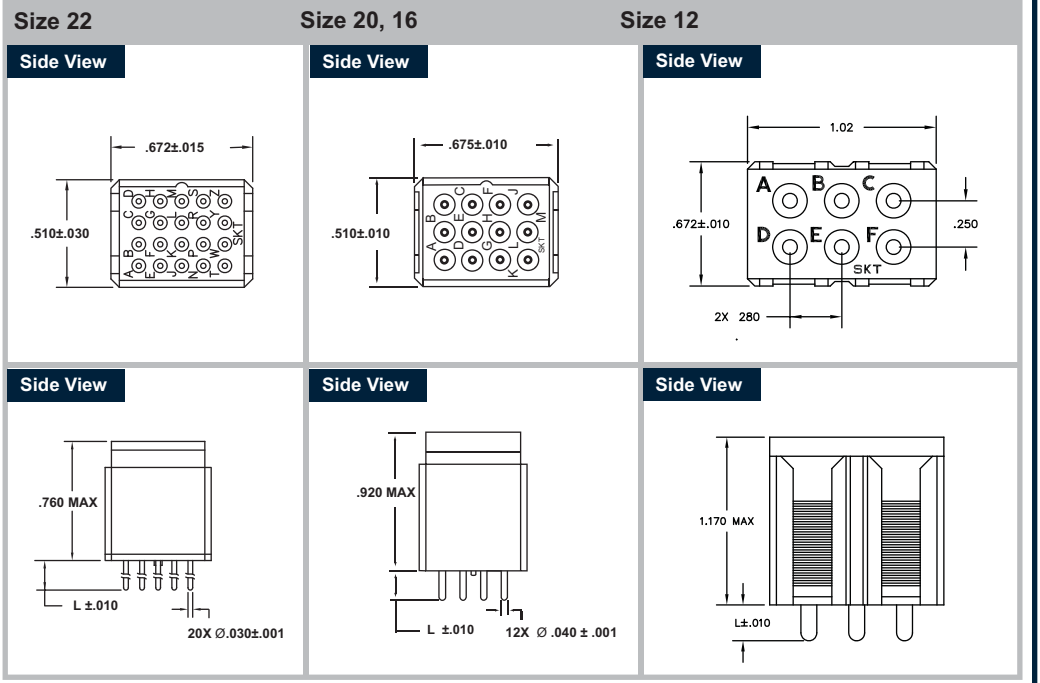

Electronic Socket Junction Modules

SJE Component Modules

Operating Range

Temperature:

-65°C to 200°C

Insulation Resistance:

5000 Megaohms Min.

Dielectric Withstanding Voltage:

1500 VRMS at Sea Level

200 VRMS at 100,000 ft.

Vibration & Shock:

Per MIL-T-81714

Paragraph 3.5.5 & 3.5.8

Materials

Insulator Body:

Polyetherimide per ASTM-D-5205

Grommet:

Silicone Rubber per A-A-59588

Internal Contact:

Copper Alloy, Gold Finish

per SAE-AMS-MIL-G-45204

Socket Junction Modules



Electronic Socket Junction Modules

Circuit Diagram	APCD P/N	Component	Quantity
	SJE020001	Diode	5
	SJE020003	Diode	4
	SJE020006	Resistor	5
	SJE020008	Diode	2
	SJE020009	Diode	5
	SJE020016	Diode	5
	SJE020017	Resistor	4
	SJE020022	Diode	5
	SJE020045	Diode	5
	SJE020290	Resistor	2
	SJE020297	Fuse	5

Product Descriptions

Amphenol Pcd's Electronic Socket Junction Modules are available with a variety of components and in a wide range of configurations. Components available include, but are not limited to, diodes, resistors, fuses, thyristors, and inductors, and are also available with multiple components within one module. There are new configurations produced regularly and customized components are also available.

Junction Module Dimensions

Side View

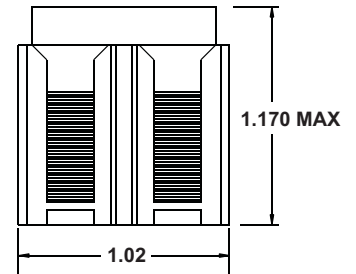

Top View

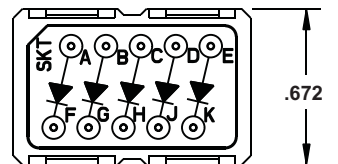

Amphenol Pcd

M81714/65 Sealed In-Line Splices

SJS Series II Single and Double

Socket Junction Splices



Operating Range

Temperature:
-65°C to 200°C

Insulation Resistance:
5000 Megaohms Min.

Dielectric Withstanding Voltage:
1500 VRMS at Sea Level
200 VRMS at 100,000 ft.

Vibration & Shock:
Per MIL-T-81714
Paragraph 3.5.5 & 3.5.8

Current Rating:
13 Amps (Size 16)
7.5 Amps (Size 20)
5 Amps (Size 22)

Materials

Insulator Body:
Polyetherimide per ASTM-D-5205

Grommet:
Silicone Rubber per A-A-59588

Internal Contact:
Copper Alloy, Gold Finish
Accordance with MIL-G-45204

Product Description

Series II In-Line Splices are available in single and double configurations in sizes 16, 20, and 22 AWG. These M81714/65 Splices use the same advanced polyetherimide body, one-piece bus assembly and construction as Amphenol Pcd's other M81714 connectors.

Single SJS Splices

	Military P/N	APCD P/N	Ø Diameter
	M81714/65-16-1	SJS316700	.324 Max
	M81714/65-20-1	SJS320700	.290 Max
	M81714/65-22-1	SJS322700	.230 Max

Sealed Splice Contacts

In-Line Splice	Contact
M81714/65-16-1	M39029/22-193
M81714/65-20-1	M39029/22-192
M81714/65-22-1	M39029/22-191
M81714/65-16-2	M39029/22-193
M81714/65-20-2	M39029/22-192
M81714/65-22-2	M39029/22-191

Double SJS Splices

	Military P/N	APCD P/N	A	B	C
	M81714/65-16-2	SJS316701	.548 Max	.304 Max	.180 Max
	M81714/65-20-2	SJS320701	.481 Max	.271 Max	.150 Max
	M81714/65-22-2	SJS322701	.384 Max	.204 Max	.120 Max

Splice Dimensions

SJS Single Splice

Side View

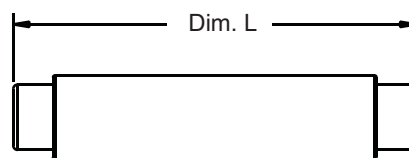

Wire Size Dimension L

Size 16	1.452 Max
Size 20	1.434 Max
Size 22	1.310 Max

SJS Double Splice

Side View

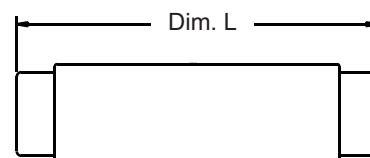

Wire Size Dimension L

Size 16	1.428 Max
Size 20	1.428 Max
Size 22	1.322 Max

M81714/67 Series II

Socket Junction Module Mounting Tracks

Operating Range

Temperature:

-65° to 200°C

Corrosion:

No Exposure of Base Metal
After 48 Hours of Salt Spray

Magnetic Permeability:

2.0 MU Max.

Vibration and Shock:

Per MIL-T-81714 Paragraph

3.5.5 and 3.5.8

Materials

Rail:

Aluminum Alloy, Black Anodized

Spring Clips:

Stainless Steel

Rivets:

Stainless Steel

Socket Junction Modules



Socket Junction Modules Mounting Tracks

Military P/N	APCD	Mounting Pos.*	Dimensions	
			A	B
M81714/67-02	SJT502404	2	1.036	0.518
M81714/67-03	SJT503404	3	1.554	1.036
M81714/67-04	SJT504404	4	2.072	1.554
M81714/67-05	SJT505404	5	2.590	2.072
M81714/67-06	SJT506404	6	3.108	2.590
M81714/67-07	SJT507404	7	3.626	3.108
M81714/67-08	SJT508404	8	4.144	3.626
M81714/67-09	SJT509404	9	4.662	4.144
M81714/67-10	SJT510404	10	5.180	4.662
M81714/67-12	SJT512404	12	6.216	5.698
M81714/67-13	SJT513404	13	6.734	6.216
M81714/67-14	SJT514404	14	7.252	6.734
M81714/67-15	SJT515404	15	7.770	7.252
M81714/67-16	SJT516404	16	8.288	7.770
M81714/67-18	SJT518404	18	9.324	8.806
M81714/67-19	SJT519404	19	9.842	9.324
M81714/67-20	SJT520404	20	10.360	9.842
M81714/67-21	SJT521404	21	10.878	10.360
M81714/67-25	SJT525404	25	12.950	12.432
M81714/67-30	SJT530404	30	15.540	15.022
M81714/67-32	SJT532404	32	16.576	16.058
M81714/67-40	SJT540404	40	20.720	20.202

*Size 12 Modules require two mounting positions

Removal Tools

MIL P/N	APCD P/N	Description
M81714/69-01	CNA051300	Single
M81714/69-02	CNA052300	Double

Removal Tools

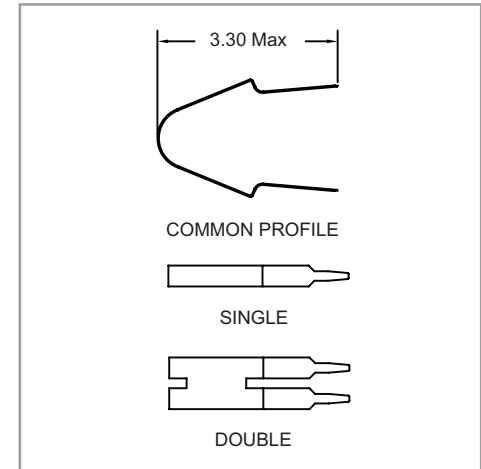

Socket Junction Track Dimensions

Top View

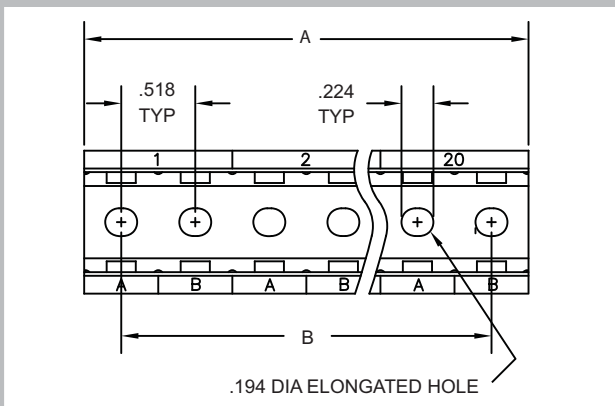

Cross Section

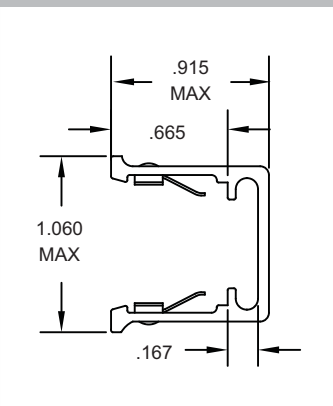

Amphenol Pcd

M81714/67 Series II

Composite Socket Junction Module Mounting Tracks

Socket Junction Modules



Operating Range

Temperature:

-65° to 175°C

Vibration and Shock:

Per MIL-T-81714 Paragraph

3.5.5 and 3.5.8

Materials

Rail:

Glass Filled Polyetherimide,

Color: Black

Product Description

The SJTC Mounting Track is fabricated of glass-filled polyetherimide which was selected for its unique combination of high strength, lightweight, chemical resistance and dimensional stability. The track is available with 2 through 20 mounting positions and is inter-changeable with existing aluminum track. The new track is 45% lighter than the aluminum track and 10% lighter than any other series II track available, and meets all dimensional requirements of MIL-T-81714.

Composite Socket Junction Module Mounting Tracks

Military Equivalent P/N	APCD P/N	Mounting Pos.	Dimensions	
			A	B
M81714/67-02	SJTC02000	2	1.036	0.518
M81714/67-03	SJTC03000	3	1.554	1.036
M81714/67-04	SJTC04000	4	2.072	1.554
M81714/67-05	SJTC05000	5	2.590	2.072
M81714/67-06	SJTC06000	6	3.108	2.590
M81714/67-07	SJTC07000	7	3.626	3.108
M81714/67-08	SJTC08000	8	4.144	3.626
M81714/67-09	SJTC09000	9	4.662	4.144
M81714/67-10	SJTC10000	10	5.180	4.662
	SJTC11000	11	5.698	5.180
M81714/67-12	SJTC12000	12	6.216	5.698
M81714/67-13	SJTC13000	13	6.734	6.216
M81714/67-14	SJTC14000	14	7.252	6.734
M81714/67-15	SJTC15000	15	7.770	7.252
M81714/67-16	SJTC16000	16	8.288	7.770
	SJTC17000	17	8.806	8.288
M81714/67-18	SJTC18000	18	9.324	8.806
M81714/67-19	SJTC19000	19	9.842	9.324
M81714/67-20	SJTC20000	20	10.360	9.842

*Size 12 Modules require two mounting positions

Removal Tools

MIL P/N	APCD P/N	Description
M81714/69-01	CNA051300	Single
M81714/69-02	CNA052300	Double

Removal Tools

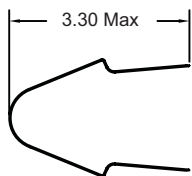

COMMON PROFILE

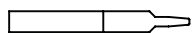

SINGLE

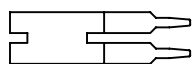

DOUBLE

Composite Socket Junction Module Mounting Tracks

Top View

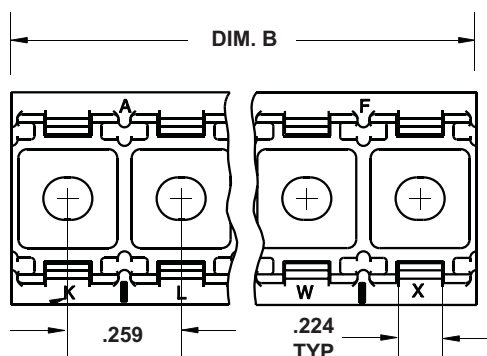

Cross Section

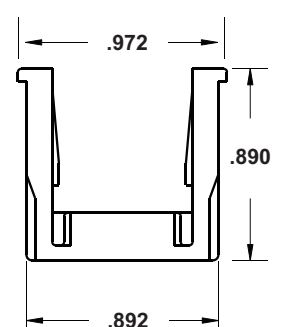

X-ON Electronics

Largest Supplier of Electrical and Electronic Components

Click to view similar products for [Socket Junction Modules](#) category:

Click to view products by [Amphenol](#) manufacturer:

Other Similar products are found below :

[00175820202](#) [00610700081](#) [BTJ716K01D-7067](#) [BTJ720E01B-513](#) [SJG016100](#) [BTJ116E02B](#) [BTM-16-513](#) [SJG020200](#) [SJTC08000](#)
[BTJ722K01C-7067](#) [BTL-20-513](#) [BTJ116E03A-513](#) [BTJ120E03D-513](#) [BTJ716E01D-513](#) [BTJ116E02B-513](#) [BTJ122E05E-513](#) [SJG016200](#)
[BTL-16-513](#) [BTM-16](#) [BTM-22-513](#) [BTL-16](#) [00170511156](#) [BTM-22](#) [SJE020016](#) [SJE020045](#) [A85049124S25W](#) [A85049124S13W](#)
[A85049124S17W](#) [A85049124S11W](#) [SJE020053](#) [BTJ122E10A-513](#) [M81969/14-04](#) [SJG316171](#) [BTL-12](#) [SJG320171](#) [M81714/60-22-10](#)
[00175110100](#) [00175110600](#) [00111510102](#) [00175110200](#) [00175110800](#) [00175110700](#) [00175110107](#) [00175110507](#) [00111510502](#)
[00175110300](#) [00111510202](#) [00175110207](#) [00175110400](#) [00175110900](#)