

THIS DOCUMENT IS SUBJECT TO CHANGE WITHOUT NOTICE. IT IS CONFIDENTIAL AND A PROPERTY OF Amphenol LTW. DISCLOSURE TO THIRD PARTY HAS TO BE AUTHORIZED BY Amphenol LTW.

REV.	ECN NO.	DATE	SIGN	DESCRIPTION
A		2020/12/31	Wen	Rev.03 to Rev.A

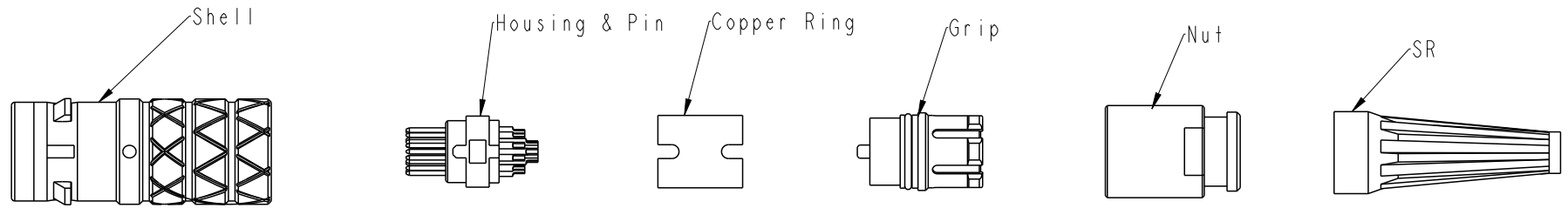
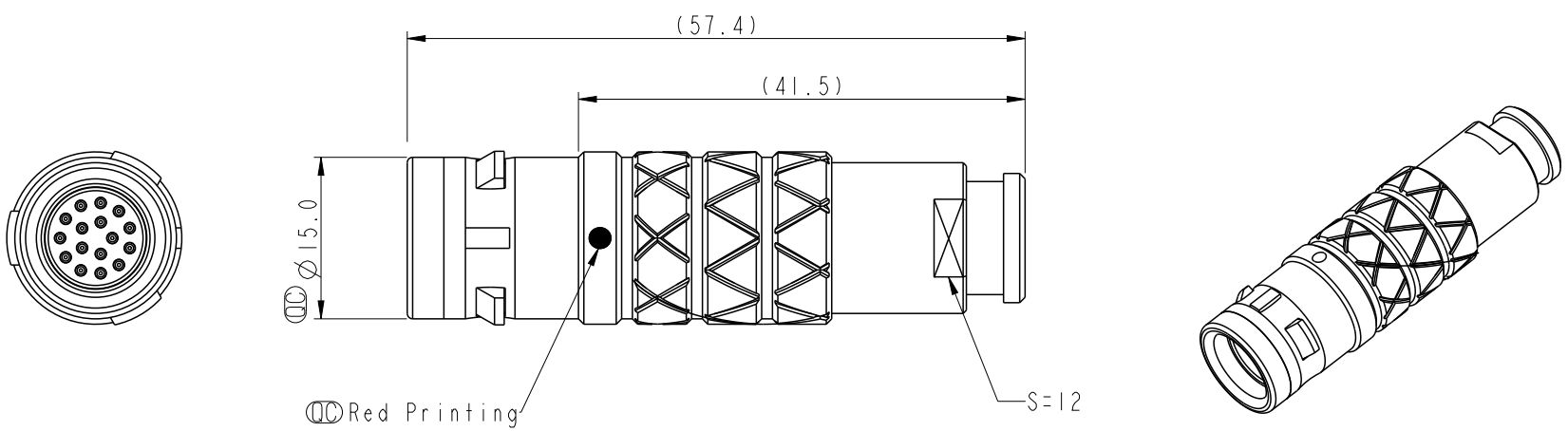

- Notes:
- * $\text{\textcircled{C}}$ Important Dimensions To Check
 - * Waterproof Rate: IP68. (Mated)
 - * Shell: Metal
 - * Housing: Thermoplastic, Black
 - * Pin: Copper Alloy, Gold Plated.
 - * Copper Ring: Metal
 - * Grip: Metal
 - * Seal & O-Ring: Rubber, Gray
 - * Nut: Metal
 - * SR: Thermoplastic, Black
 - * One Set Assembled In One PE Bag(small)
 - * 20 Sets In One PE Bag(BIG)

UNIT:mm			TITLE FLO D SIZE, G CODE, FI CONNECTOR
TOLERANCE $\pm 0.5\text{mm}$	SCALE 1:1	SIZE A4	SHEET 1 OF 2
REV. A	WC-REV. .0	$\text{\textcircled{C}}$: Inspection item	

Amphenol LTW
安費諾亮泰企業股份有限公司

ITEM NO	DRAWN BY Wen	DATE 2020/12/31
DWG NO SLKD-XXFGMS-GCP-XXX	CHECKED BY Neo	DATE 2020/12/31
CUSTOMER ALTW	APPROVED BY Max	DATE 2020/12/31

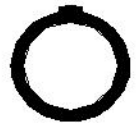

THIS DOCUMENT IS SUBJECT TO CHANGE WITHOUT NOTICE. IT IS CONFIDENTIAL AND A PROPERTY OF AMPHENOL LTW. DISCLOSURE TO THIRD PARTY HAS TO BE AUTHORIZED BY AMPHENOL LTW.

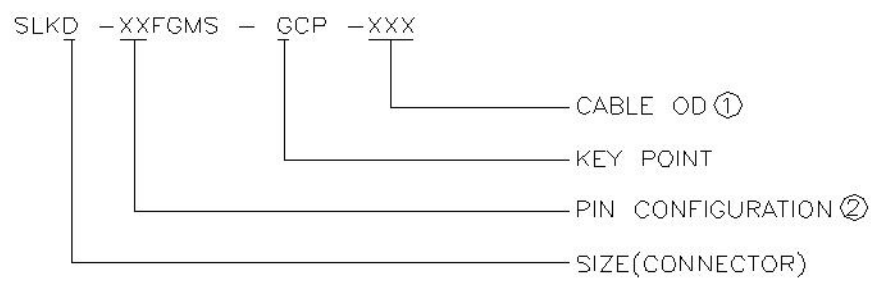
KEY POINT	
CODE	G
GRAPHIC	

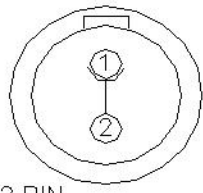
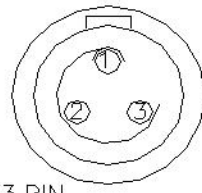
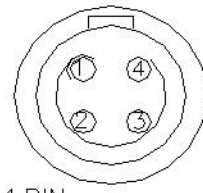
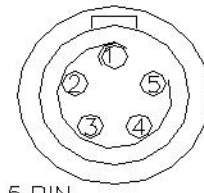
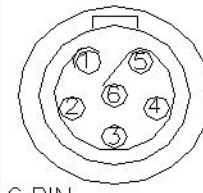
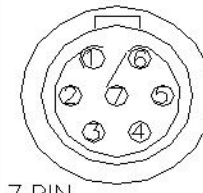
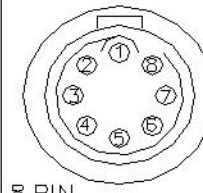
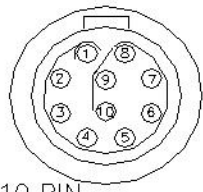
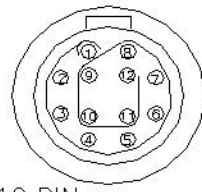
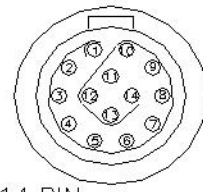
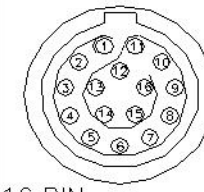
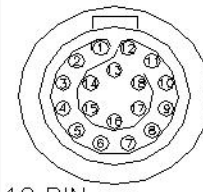
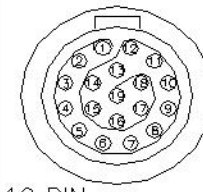
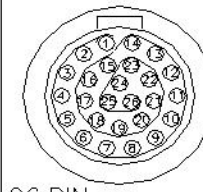

2K-SERIES CABLE COLLET(CABLE OD)			
CABLE CLAMP SET		CABLE DIA RANGE	
TYPE	CODE ①	MAX	MIN
SLKD-XXFGMS-GCP-XXX	226	7.6	6.5
	227	8.7	7.7
	--	--	--
	--	--	--

PIN CONFIGURATION (Solder Definition) ②							
GRAPHIC							
	2 PIN	3 PIN	4 PIN	5 PIN	6 PIN	7 PIN	8 PIN
							
	10 PIN	12 PIN	14 PIN	16 PIN	18 PIN	19 PIN	26 PIN

UNIT:mm			TITLE FLO D SIZE, G CODE, FI CONNECTOR
TOLERANCE ±0.5mm	SCALE 1:1	SIZE A4	SHEET 2 OF 2
	REV. A	WC-REV. .0	QC: Inspection item

Amphenol LTW
安費諾亮泰企業股份有限公司

ITEM NO	DRAWN BY Wen	DATE 2020/12/31
DWG NO SLKD-XXFGMS-GCP-XXX	CHECKED BY Neo	DATE 2020/12/31
CUSTOMER ALTW	APPROVED BY Max	DATE 2020/12/31

X-ON Electronics

Largest Supplier of Electrical and Electronic Components

Click to view similar products for [Circular Push Pull Connectors](#) category:

Click to view products by [Amphenol](#) manufacturer:

Other Similar products are found below :

[6407-249V-11273P](#) [6408-201V-13273](#) [6408-202V-13343](#) [6408-202V-17343](#) [FAG.2B.319.CYC](#) [FGA.1B.307.CYCD72Z](#)
[FGC.0B.309.CLAD56](#) [FLS.01.250.DLAE24](#) [PFG.1B.308.CYZZ](#) [PKG.M0.6BL.LZ](#) [PLC.M1.0SL.LA](#) [GMA.2B.045.DJ](#) [GMA.3B.090.DA](#)
[PRG.M0.6GL.LC52GZ](#) [ABF.1S.250.NTA](#) [1332M107MS](#) [EAJ.1B.306.CWA](#) [1589430-2](#) [ELF.00.250.NTL](#) [ERA.01.250.DLL](#)
[BRD.0B.200.PCSG](#) [HVP.03.250.CLLPV](#) [CAH.M34.SLL.C72GZ](#) [CAJ.M34.SLL.C72GZ](#) [300500](#) [EXG.0B.309.HLN](#) [FFB.1S.250.CLAC27](#)
[FLC.00.250.CTAC31](#) [FPG.0B.305.CLAD52](#) [PCS.01.250.DLLE31](#) [PKC.M0.7GL.NG](#) [PKG.M0.4TL.LZ](#) [PXG.M0.8GG.NG](#)
[HEG.1B.307.CLNP](#) [BRR.3S.200.PZVG](#) [JDXEP2T19FSN](#) [400374](#) [DTA.99.700.5Z](#) [ECG.00.304.CLL](#) [ECP.0S.304.CLN](#) [EEG.1B.306.CYZ](#)
[MS3117-12BU](#) [EGA.00.303.CLL](#) [SAN.M13.GLA.6G](#) [6408-201V-11343](#) [6408-202V-25273](#) [PAC.M0.4NL.AC52J](#) [980-0009-471](#)
[NCG044SC2DC006](#) [13303PM20](#)