

Amphenol®



SurLok Plus™ Series

www.amphenol-industrial.com

Company Profile



Endicott, NY

Amphenol Industrial Operations

Amphenol Industrial Operations, headquartered in a 50,000 square foot facility in Endicott, N.Y., provides a full range of high reliability power/signal connectors and interconnection systems specifically for the industrial markets including rail/mass transit, process control, automotive manufacturing, heavy equipment, wireless base stations and petrochemical/power generation.

Products include ruggedized-for-industry cylindrical, rectangular, fiber optic, signal and power, RADSOK power and power-to-board solutions, cable and harness assemblies, as well as industrialized versions of Amphenol's MIL-DTL-5015 cylindrical, MIL-DTL-26482 miniature cylindrical and GT reverse bayonet cylindrical connectors. Amphenol Industrial Operations employs more than 1,400 people globally and is ISO9001, TS96949 and MIL-STD-790 certified.



Amphenol Technology (Zhuhai) Co., Ltd

Established in 2007, Amphenol Technology (Zhuhai) Co., Ltd. is a manufacturing facility for Amphenol Industrial Operations, which serves a number of industrial markets. Included but not limited to Factory Automation, Transportation, Heavy Equipment, Alternative Energy, Energy Storage. Server/Data Comm and Power Distribution.

Amphenol Technology (Zhuhai) Co., Ltd. covers an area of 276,000 ft² and is equipped with CNC, plating, injection molding and assembly workshops. This plant specializes in the design and manufacturing of industrial connectors featuring high power, high density, medium to high voltage electrical properties, and harsh environment applications.

With industry leading engineering, design and manufacturing expertise, Amphenol Technology(Zhuhai) Co., Ltd. has earned more than 60 utility patents on its innovative interconnects. Many of the products produced have been certified by independent standards including UL, IEC/TUV, ATEX, IECEx and MA. The facility is also certified to ISO 9001, ISO 14001 and IATF 16949.

Overview



Table of Contents

What is SurLok Plus™ ?	4
Markets.....	4
Features and Benefits	5
Technical Information.....	5
1000V Product Dimensions – Receptacle.....	6
1000V Ordering information – Receptacle	6
1000V Product Dimensions – Plug.....	7
1000V Ordering Information – Plug.....	7
1000V EMI Product Dimensions.....	8
1000V EMI Ordering Information.....	8
1500V EMI Product Dimensions.....	9
1500V EMI Ordering Information.....	9
1500V Product Dimensions	10
1500V Ordering Information	10
Layout Dimensions	11
Optional Accessories	11
Keyway Reference	14
Tools	16
Patents	17
Customized Cable Assemblies.....	17

What is SurLok Plus™?



The SurLok Plus™ compression lug is a field installable, highly reliable alternative to common compression lugs

Using industry standard crimp, screw, and busbar termination options, thus eliminating the need to purchase special torque tools.

SurLok Plus™ is an environmentally sealed version of our original SurLok® but available in smaller sizes, and features a quick lock and press-to-release design. Incorporating the latest R4 RADSOK® Technology. SurLok Plus™ is a compact, quick mating, and robust product line.

The RADSOK® high amperage contact technology utilizes high tensile strength properties of a stamped and formed, high conductivity alloy grid to produce low insertion forces while maintaining a large conductive surface area. The R4 version of the RADSOK® represents the culmination of three years of research and development in laser welding copper based alloys.

Markets

The markets and applications for the SurLok Plus™ Series include but are not limited to the following:



Energy Storage



EV/HEV

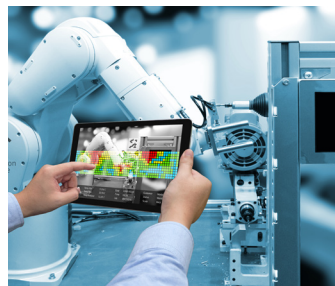

Process Control/Automation



Heavy Equipment

Features and Benefits

Keyway	Multiple keyways
Lock	Quick lock and press-to-release design
Plug	360° rotating plug optional
Receptacle	Various termination options (Thread, Crimp, Busbar)
Voltage	1000V / 1500V optional
Protection	Touch Proof
Design	Compact robust design

- The connector's design incorporates an integral latching system that ensures a definitive electrical and mechanical connection.
- Connector housings are manufactured with a thermoplastic material that is not only durable, but also with excellent dielectric, mechanical properties and meet environmentally RoHS compliant.
- Contacts are derived from quality copper alloy to ensure an electrically-reliable connection.
- UL1977/4128 and TUV 2PFG2740 certified

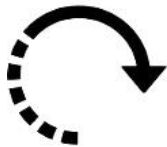

Rotation

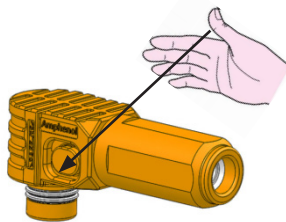

Quick lock and press-to-release design



1000/1500 VDC

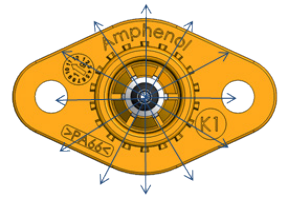

Multi-directional outgoing

Technical Information

Description	RADSOK® Size					
	3.6mm	5.7mm	8.0mm	8.0mm EMI	10.3mm	14mm EMI
Current Rating	50A~70A	100A~120A	120A~200A	150A~250A	250A~350A	250A~500A
Operating Temperature	-40°C~125°C	-40°C~125°C (1000V DC)	-40°C~125°C (1000V DC)	-40°C~125°C (1000V DC)	-40°C~125°C (1000V DC)	-40°C~125°C (1500V DC)
		-40°C~125°C (1500V DC)	-40°C~125°C (1500V DC)		-40°C~125°C (1500V DC)	
Sealing	IP67(Mated)	IP67(Mated)	IP67(Mated)	IP67(Mated)	IP67(Mated)	IP67(Mated)
Flammability	UL 94 V-0	UL 94 V-0	UL 94 V-0	UL 94 V-0	UL 94 V-0	UL 94 V-0
Locking	Spring Locking	Spring Locking	Spring Locking	Spring Locking with CPA	Spring Locking	Spring Locking with CPA
RoHS Compliant	Yes	Yes	Yes	Yes	Yes	Yes
EMI Shielding	No	No	No	Yes	No	Optional
HVIL Function	No	No	No	Yes	No	Optional
Durability	≥100 cycles	≥100 cycles	≥100 cycles	≥100 cycles	≥100 cycles	≥100 cycles
IPXXB	Yes	Yes	Yes	Yes	Yes	Yes

Notes: For IP6K9K consult tech@ amphenol-ai. com.

1000V DC Product Dimensions - Receptacle

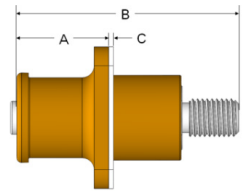
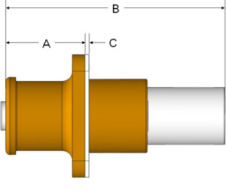
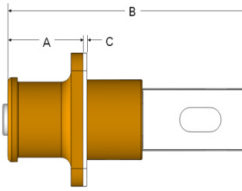
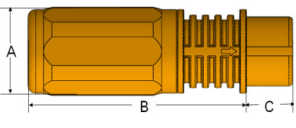
Item	Screw Termination			Crimp Termination			Busbar Termination			Inline Crimp Termination		
Size												
	A	B	C	A	B	C	A	B	C	A	B	C
5.7mm	16.5	36.7	1.0 Ref.	16.5	40.7	1.0 Ref.	16.5	46.7	1.0 Ref.	20	53.7 Ref	8.8
8.0mm	19.0	46.2	1.0 Ref.	19.0	52.7	1.0 Ref.	19.0	61.2	1.0 Ref.	24.3	56.7 Ref	12
10.3mm	25.8	55.5	0.3 Ref.	25.8	50mm ² : 65.8	0.3 Ref.	25.8	68.8	0.3 Ref.	/	/	/
					70mm ² : 68.8							
					85mm ² : 71.8							

Note: All dimensions for reference only

Ordering Information - Receptacle

Product Series	Type	RADSOK® Size	Termination Style		Panel Mount	Sealing	Color	Keyway****					
SLP	R	A	5.7mm 120A	B	Busbar	P	W/ Flange	S	IP67	O	Orange	0	90°
				T	Threaded Post								
				16C	16mm ² Crimp								
				25C	25mm ² Crimp								
				B	Busbar								
				T	Threaded Post								
	IR	B	8.0mm 200A	25C	25mm ² Crimp	N	W/O Flange**	N	Non- Sealed	B	Black	1	180°
				35C	35mm ² Crimp								
				50C	50mm ² Crimp								
				B	Busbar								
				T	Threaded Post								
				50C	50mm ² Crimp								
CR	*Inline Receptacle	C	10.3mm 350A	B	Busbar	B	W/ Back shells***	N	Non- Sealed	R	Red	2	60°
				T	Threaded Post								
				50C	50mm ² Crimp								
				70C	70mm ² Crimp								
				85C	85mm ² & 95mm ²								
				16	16mm ²								
A	5.7mm 120A	B	8.0mm 200A	25	25mm ²	N	W/ Flange	S	IP67	O	Orange	3	120°
				35	35mm ²								
				50	50mm ²								
				50	50mm ²								

*Inline receptacle, 90° and 120° keyways only ** Not available for 10.3mm ***Only available for inline type **** 10.3mm requires Keyway selection
Note: All dimensions for reference only

Example:

1	2	3	4	5	6	7	8
Product Series	Type	RADSOK® Size	Cable Size	Back shells	Sealing	Color	Keyway
SLP	IR	A	25	B	S	O	3
SLP	CR	B	50	B	N	B	0

SLPIRA25BSO3: 5.7mm SurLok Plus™ Receptacle without shielding and no HVIL, orange, 25mm² cable crimp, waterproof: sealed, keyway: 120°

SLPCRB50BNB0: 8.0mm SurLok Plus™ Inline receptacle without shielding and no HVIL, black, 50mm² cable crimp, waterproof: non-sealed, keyway: 90°

1000V DC Product Dimensions - Plug

Item	Right Angle Plug				Straight Plug			
Size								
	A	B	C	D	A	B	C	D
5.7mm	22.6	55.1 Ref	30	18	22.5	63 Ref	30.5	20
8.0mm	29	74.5 Ref	38.4	21.6	24.45	72.4 Ref	34.8	21.4
10.3mm	41.2	83.5 Ref	42.5	28	/	/	/	/

Note: All dimensions for reference only

Ordering Information - Plug

Product Series	Type	RADSOK® Size	Cable Size		Back Shells		Sealing		Color		Keyway****		
			A	B	B	W/ Back Shells	S	Sealed	O	Orange	0	90°	
SLP	P	A	5.7mm 120A	16	16mm ²	B	W/ Back Shells	S	Sealed	O	Orange	NO KEYWAY	
				25	25mm ²								
			B	8.0mm 200A	25								25mm ²
		35			35mm ²								
		50		50mm ²									
		C	10.3mm 350A	50	50mm ²								
	70			70mm ²									
	85			85mm ² & 95mm ²									
	1			180°									
	IP	Straight Type	A	5.7mm 120A	16	16mm ²	N	W/O Back Shells	N	Non-Sealed	B	Black	2
25					25mm ²								
B			8.0mm 200A	25	25mm ²								
				35	35mm ²								
50	50mm ²	3	120°										
4	150°												

*Inline receptacle, 90° and 120° keyways only ** Not available for 10.3mm ***Only available for inline type **** 10.3mm requires Keyway selection
 Note: All dimensions for reference only

Example:

1	2	3	4	5	6	7	8
Product Series	Type	RADSOK® Size	Cable Size	Back shells	Sealing	Color	Keyway
SLP	P	A	25	B	S	O	
SLP	IP	A	25	B	S	O	3

SLPPA25BSO: 5.7mm SurLok Plus™ Right Angle Plug without shielding and no HVIL, orange, 25mm² cable, waterproof: sealed, keyway: NO KEYWAY

SLPIPA25BSO3: 5.7mm SurLok Plus™ Straight Plug without shielding and no HVIL, orange, 25mm² cable crimp, waterproof: sealed, keyway: 120°

1000V DC EMI Product Dimensions

Item	Right Angle Plug				Straight Plug			Receptacle			
Size											
	A	B	C	D	A	B	C	A	B	C	D
8.0mm	26.2	41.2	86.2	25.8	82.5	34.3	30	25.15	22.85	2.5	23.5

Note: All dimensions for reference only

1000V DC EMI Ordering Information

Product Series	Type		RADSOK® Size		Cable Size		Back Shells		Sealing		Color		Keyway		EMI		HVIL		
SLP	P	Right Angle 90°	B	8.0mm 250A	35	35mm²	B	W/ Back shells	S	Sealed	O	Orange	0	90°	E	EMI	H	HVIL	NON HVIL
					1	270°													
	IP	Straight Type			50	50mm²			N	Non-Sealed	B	Black	2	60°					
					70	70mm²					R	Red	3	120°					
Product Series	Type		RADSOK® Size		Termination Style		Panel Mount		Sealing		Color		Keyway		EMI		HVIL		
SLP	IR	Receptacle Keyway can rotate 360°	B	8.0mm	B	Busbar	P	Panel Mount W/ Flange	S	Sealed	O	Orange	0	90°	E	EMI	H	HVIL	NON HVIL
													1	270°					
									N	Non-Sealed	B	Black	2	60°					
											R	Red	3	120°					

Note: All options for reference only

Example:

1	2	3	4	5	6	7	8	9	10
Product Series	Type	RADSOK® Size	Cable Size	Back shells	Sealing	Color	Keyway	EMI	HVIL
SLP	P	B	50	B	S	O	3	E	
Product Series	Type	RADSOK® Size	Termination Style	Panel Mount	Sealing	Color	Keyway	EMI	HVIL
SLP	IR	B	B	P	S	O	1	E	H

SLPPB50BSO3E: 8.0mm SurLok Plus™ Right Angle Plug with shielding and no HVIL, orange, 50mm² cable, waterproof: sealed, keyway: 120°

SLPIRBBPSO1EH: 8.0mm SurLok Plus™ Receptacle with EMI and HVIL, orange, busbar panel, keyway: 270°, waterproof: sealed

1500V DC (EMI) Product Dimensions

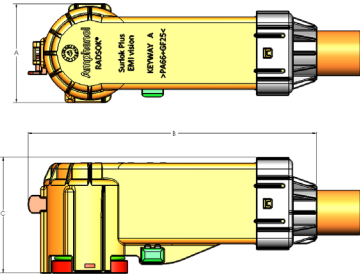
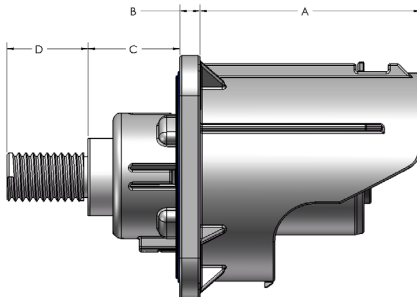
Item	Right Angle Plug			Receptacle			
Size							
	A	B	C	A	B	C	D
14mm	70	176	71	59.5	5	22.7	20

Note: All dimensions for reference only

1500V DC (EMI) Ordering Information

Product Series	Type		RADSOK® Size	Cable Size		Back Shells		Sealing		Color		Keyway		EMI	HVIL			
SLP	HP	Right Angle 90°	E	14mm 450A	S095	95mm ² (Shield)	B	W/ Back shells	S	Sealed	O	Orange	A	Keyway A	E	EMI	N	NON HVIL
					S120	120mm ² (Shield)							B	Keyway B				
					S150	150mm ² (Shield)					C	Keyway C						
	HIP	Straight Type			U095	95mm ² (Unshield)			N	Non-Sealed	R	Red	D	Keyway D			H	HVIL
						U120							120mm ² (Unshield)	E				
						U150					150mm ² (Unshield)							
Product Series	Type		RADSOK® Size	Termination Style		Panel Mount		Sealing		Color		Keyway		EMI	HVIL			
SLP	HR	Receptacle Keyway can rotate 360°	E	14mm 450A	B	Busbar	P	Panel Mount W/ Flange	S	IP67	G	Gray	A	Keyway A	E	EMI	N	NON HVIL
					C	Keyway C												
					D	Keyway D												
					N	Non-Sealed			E	Keyway E			H	HVIL				

Note: All options for reference only

Example:

1	2	3	4	5	6	7	8	9	10
Product Series	Type	RADSOK® Size	Cable Size	Back shells	Sealing	Color	Keyway	EMI	HVIL
SLP	HP	E	S150	B	S	O	C	E	N
Product Series	Type	RADSOK® Size	Termination Style	Panel Mount	Sealing	Color	Keyway	EMI	HVIL
SLP	HR	E	B	P	S	G	B	E	H

SLPPE150BSOCEN: 14.0mm SurLok Plus™ Right Angle Plug with shielding and no HVIL, orange, 150mm² shielding cable, waterproof: sealed, keyway: C

SLPHREBPSGBEH: 14.0mm SurLok Plus™ Receptacle with EMI and HVIL, Gray, busbar panel, keyway: B, waterproof: sealed

1500V DC Product Dimensions

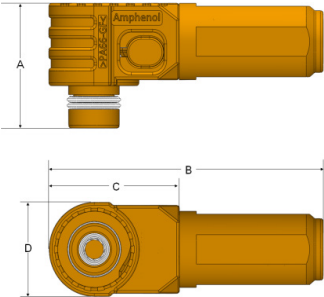
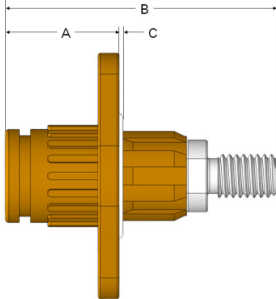
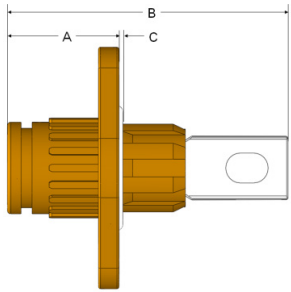
Item	Right Angle Plug				Screw Termination			Busbar Termination		
Size										
	A	B	C	D	A	B	C	A	B	C
3.6mm	21.2	48.6	23.1	16	16.3	39	0.5 Ref.	16.3	41	0.5 Ref.
5.7mm	27.5	66.2	30.5	20	19.8	47.3 Ref.	0.25 Ref.	19.3	48.3	0.25 Ref.
8.0mm	34	82.2	38.4	24.3	22	57.1	0.35 Ref.	22	60	0.35 Ref.
10.3mm	43	97.5	40.5	30	27	70	0.25 Ref.	27	69	0.25 Ref.

Note: All dimensions for reference only

1500V DC Ordering Information

Product Series	Type		RADSOK® Size		Cable Size		Back Shells		Sealing		Color		Keyway					
SLP	HP	RA Type	M	3.6mm 70A	06	6 mm ²	B	W/ Backshells	S	Sealed	O	Orange	1	20°				
					10	10mm ²												
			A	5.7mm 120A	16	16mm ²					N	Non-Sealed	B	Black	2	30°		
					25	25mm ²												
			B	8.0mm 200A	35	35mm ²					R	Red	3	45°				
					50	50mm ²												
C	10.3mm 350A	70	70mm ²	95	95mm ²													
Product Series	Type		RADSOK® Size		Termination Style		Panel Mount		Sealing		Color		Keyway					
SLP	HIR	Receptacle W/ Keyway	M	3.6mm 70A	B	Busbar	P	Panel Mount W/ Flange	S	IP67	O	Orange	1	20°				
															A	5.7mm 120A		
			B	8.0mm 200A							T	Threaded Post	N	Non-Sealed	B	Black	2	30°

Note: All options for reference only

Example:

1	2	3	4	5	6	7	8
Product Series	Type	RADSOK® Size	Cable Size	Back shells	Sealing	Color	Keyway
SLP	HP	M	10	B	S	B	1
Product Series	Type	RADSOK® Size	Termination Style	Panel Mount	Sealing	Color	Keyway
SLP	HIR	M	B	P	S	R	2

SLPHPM10BSO1: 3.6mm SurLok Plus™ 1500V Right Angle Plug , without shielding and no HVIL, black, 10mm² cable crimp, waterproof: sealed, keyway: 20°

SLPHIRMBPSR2: 3.6mm SurLok Plus™ 1500V Receptacle without shielding and no HVIL, red, busbar, waterproof: sealed, keyway: 30°

Layout Dimensions

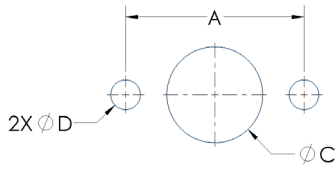
RADSOK® Size	A	ØC	D	Layout Torque	Receptacle Contact Torque		Figure
					Busbar Torque	Screw Torque	
3.6mm	24±0.1	12.9±0.2	M4 Screw	0.4~0.7N.m	M4 Screw 1.2~1.5N.m	/	

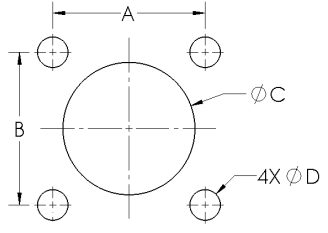
RADSOK® Size	A	B	ØC	D	Layout Torque	Busbar Torque	Screw Torque	Figure
5.7mm	18±0.1	18±0.1	14.4±0.2	M4 Screw	M4 bolts: 0.4~0.7N.m	M5 bolts: 2N.m max	M6 Nut: 2N.m max	
8.0mm	21±0.1	21±0.1	18.4±0.2	M4 Screw	M4 bolts: 0.4~0.7N.m	M5 bolts: 2N.m max	M8 Nut: 8N.m max	
8.0mm EMI	23±0.1	23±0.1	23.3±0.1	M3 Screw	M3 bolts: 0.7~0.9N.m	M6 bolts: 4N.m max	M6 bolts: 4N.m max	
10.3mm	24.5±0.1	24.5±0.1	22.5+0.2/-0	M4 Screw	M4 bolts: 0.4~0.7N.m	M6 bolts: 4N.m max	M10 bolts: 6N.m max	
14mm	45±0.1	45±0.1	42±0.1	M6 Screw	M6 bolts: 9.9~10.1N.m	M12 bolts: 15.1N.m max	M10 Nut: 10.1N.m max	

Note: All torques for reference only, details refer to WI.

Optional Accessories

Dust Cap

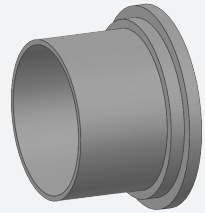
Voltage	Description	P/N	Figure
1000V DC	SL+ 5.7mm Receptacle Dust CAP	C10-070500-010	
	SL+ 8.0mm Receptacle Dust CAP	C10-070500-012	
	SL+ 8.0mm EMI Plug Dust CAP	C10-070506-10S	
	SL+ 8.0mm EMI Receptacle Dust CAP	C10-686511-016	
	SL+ 10.3mm Receptacle Dust CAP	C10-070500-016	
1500V DC	SL+ 3.6mm Receptacle Dust CAP	C10-070506-010	
	SL+ 5.7mm Receptacle Dust CAP	C10-070506-012	
	SL+ 8.0mm Receptacle Dust CAP	C10-070506-014	
	SL+ 10.3mm Receptacle Dust CAP	C10-070506-016	

Note: Generic cap image, actual shape and color may vary.

Sealing Cap

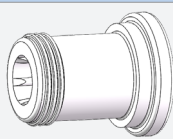
Description	P/N	Figure
SL+ 3.6mm Receptacle Sealing CAP	C10-766844-000	
SL+ 5.7mm Receptacle Sealing CAP	C10-752804-000	
SL+ 8.0mm Receptacle Sealing CAP	C10-737307-000	

Optional Accessories

Gasket

Voltage Rating	Gasket	P/N	Figure
1000V DC	SL+ 5.7mm Gasket	C10-730656-000	
	SL+ 8.0mm Gasket	C10-731812-000	
	SL+ 10.3mm Gasket	C10-731012-000	
	SL+ 8.0mm EMI Gasket	C10-738625-000	
1500V DC	SL+ 3.6mm Gasket	C10-753284-000	
	SL+ 5.7mm Gasket	C10-766105-000	
	SL+ 8.0mm Gasket	C10-766399-000	
	SL+ 10.3mm Gasket	C10-765504-000	

Crimping Barrel

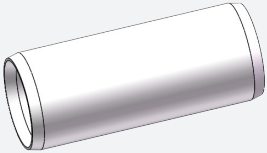
Description	P/N	Figure
SL+ 3.6mm Crimping barrel	C10-754843-063 (6mm ²)	
SL+ 5.7mm Crimping barrel	C10-737238-003 (16mm ²)	
SL+ 8.0mm Crimping barrel	C10-737127-253 (25mm ²)	
	C10-737127-003 (35mm ²)	
SL+ 8.0mm EMI Crimping barrel	C10-738626-002 (35mm ²)	
	C10-738626-001 (50mm ²)	
SL+ 10.3mm Crimping barrel	C10-737887-053 (50mm ²)	
	C10-737887-073 (70mm ²)	

Optional Accessories

Cable Grommet

Voltage Rating	Gasket	P/N	Recommended Cable OD (mm)	Figure
1000V DC	SL+ 5.7mm Rear Grommet	C10-730653-030 (16 mm ²)	Ø8.10 ± 0.2	
		C10-730653-040(25 mm ²)	Ø10.2 ± 0.2	
	SL+ 8.0mm Rear Grommet	C10-731821-020 (25 mm ²)	Ø10.2 ± 0.2	
		C10-731821-030 (35 mm ²)	Ø11.5 ± 0.3	
		C10-731821-050(50 mm ²)	Ø13.6 ± 0.3	
	SL+ 8.0mm EMI Cable Grommet	C10-738617-001 (70 mm ²)	Ø19.5 ± 0.5	
		C10-738617-002 (50 mm ²)	Ø17.0 ± 0.5	
		C10-738617-003 (35 mm ²)	Ø14.5 ± 0.5	
	SL+ 10.3mm Rear Grommet	C10-731006-050 (50 mm ²)	Ø13.6 ± 0.3	
		C10-731006-070 (70 mm ²)	Ø15.5 ± 0.3	
		C10-731006-080 (85/95 mm ²)	Ø18.2 ± 0.3	
	SL+ 5.7mm Inline Receptacle Rear Grommet	C10-766102-100: Support Piece (16 mm ² and 25 mm ²)		
		C10-766101-016 (16 mm ²)	Ø8.10 ± 0.2	
		C10-766101-025 (25 mm ²)	Ø10.2 ± 0.2	
	SL+ 8.0mm Inline Receptacle Rear Grommet	C10-762841-025 (25 mm ²)	Ø10.2 ± 0.2	
		C10-762841-035 (35 mm ²)	Ø11.5 ± 0.3	
C10-762841-050 (50 mm ²)		Ø13.6 ± 0.3		
1500V DC	SL+ 3.6mm Rear Grommet	C10-754739-006(6 mm ²)	Ø4.8 ± 0.2	
		C10-754739-010(10 mm ²)	Ø6.25 ± 0.2	
	SL+ 5.7mm Rear Grommet	C10-766102-100: Support Piece (16 mm ² and 25 mm ²)		
		C10-766623-016 (16 mm ²)	Ø8.10 ± 0.2	
		C10-766623-025 (25 mm ²)	Ø10.2 ± 0.2	
	SL+ 8.0mm Rear Grommet	C10-766102-100: Support Piece (35 mm ² and 50 mm ²)		
		C10-766624-035 (35 mm ²)	Ø11.5 ± 0.3	
		C10-766624-050 (50 mm ²)	Ø13.6 ± 0.3	
	SL+ 10.3mm Rear Grommet	C10-765499-100: Support Piece (70 mm ² and 95mm ²)		
C10-765498-070 (70 mm ²)		Ø15.5 ± 0.3		
C10-765498-090 (95 mm ²)		Ø18.2 ± 0.3		

Note: If customer's cable range is not commensurate with the recommended cable diameter, they should consult tech@amphenol-aiio.com

Keyway Reference

1000V DC Connector:

RADSOK® Size	P/N			Description	
	Type	RA Plug	Straight Plug		Receptacle
5.7mm W/O Keyway	MFG Number	C10-730186-() () ()	C10-752785-() () ()	C10-730187-() () ()	 <p>360° Rotation</p>
	Code Number	SLPPA()B() ()	SLPIPA()B() ()	SLPRA()P() ()	
5.7mm W/ Keyway	MFG Number	C10-730186-() () ()	C10-752785-() () ()	C10-730187-() () ()	 <p>Non-Rotatable</p>
	Code Number	SLPPA()B() ()	SLPIPA()B() ()	SLPIRA()P() ()	
8.0mm W/O Keyway	MFG Number	C10-730188-() () ()	C10-731951-() () () ()	C10-730189-() () ()	 <p>360° Rotation</p>
	Code Number	SLPPB()B() ()	SLPIPB()B() ()	SLPRB()P() ()	
8.0mm W/ Keyway	MFG Number	C10-730188-() () ()	C10-731951-() () ()	C10-731950-() () ()	 <p>Non-Rotatable</p>
	Code Number	SLPPB()B() ()	SLPIPB()B() ()	SLPIRB()P() ()	
10.3mm Keyway	MFG Number	C10-730190-() () ()	/	C10-730191-() () ()	 <p>360° Rotation</p>
	Code Number	SLPPC()B() ()	/	SLPIRC()P() ()	

Keyway Reference

1500V DC Connector: Multi-Directional Outgoing

RADSOK® Size	P/N			Description	
	Type	RA Plug	Straight Plug		Receptacle
3.6mm Keyway	MFG Number	C10-754726- () () ()	/	C10-754727- () () ()	
	Code Number	SLPHPM()B() ()	/	SLPHIRM()P() ()	
5.7mm Keyway	MFG Number	C10-766439- () () ()	/	C10-766440- () () ()	
	Code Number	SLPHPA()B() ()	/	SLPHIRA()P() ()	
8.0mm Keyway	MFG Number	C10-765467- () () ()	/	C10-765468- () () ()	
	Code Number	SLPHPB()B() ()	/	SLPHIRB()P() ()	
10.3mm Keyway	MFG Number	C10-765127- () () ()	/	C10-765128- () () ()	
	Code Number	SLPHPC()B() ()	/	SLPHIRC()P() ()	

Tools

Product Series	Part Number	Description	Photo
SurLok™ Plus EMI	FX3-0001-001	Shielding assembly	
SurLok™ Plus EMI	FX3-0006-001	Assembly HVIL Contact	
SurLok™ Plus	FX3-0026-001	SL+ 5.7MM screw type receptacle wrench	
SurLok™ Plus	FX3-0036-001	8.0 SL+ REC M6 Wrench	
SurLok™ Plus	FX3-0024-001	10.3mm SL wrench	
SurLok™ Plus	FX3-0042-002	SurLok™ Plus 3.6mm threading cable tool	
SurLok™ Plus	FX3-0067-001	SurLok™ Plus 10.3 SL+ 1500V fixture for grommet assy	

Patents



Customized Cable Assemblies





AMPHENOL CORPORATION
Amphenol Industrial

Phone: 888-364-9011
20 Valley Street
Endwell, NY 13760-3600
www.amphenol-industrial.com

Amphenol Technology(Zhuhai) Co., Ltd.

No.63, Xinghan Road, Sanzao Town,
Jinwan, Zhuhai, 519040
China Tel: +86-756-398 9725
Fax: +86-756-398 9768
www.amphenol-industrial.com
Email: tech@amphenol-aio.com

X-ON Electronics

Largest Supplier of Electrical and Electronic Components

Click to view similar products for [Heavy Duty Power Connectors](#) category:

Click to view products by [Amphenol](#) manufacturer:

Other Similar products are found below :

[6646058-2](#) [6646137-1](#) [6646138-1](#) [6646940-1](#) [6651091-1](#) [6651525-1](#) [6651529-1](#) [696475-1](#) [702-32-01109](#) [703-25-02205](#) [73000005059](#)
[73000005642](#) [73080254296](#) [73080255059](#) [73080965046](#) [765-15-0080A](#) [765-16-0080B](#) [765-18-0080D](#) [902-77-02113](#) [PS00/A0620/6300](#)
[129-1J](#) [1409400](#) [E6374G1](#) [e6389g2](#) [157-43GW8](#) [MS3117-14AC](#) [1643543-1](#) [1650540-1](#) [1766966-1](#) [1791340000](#) [NLDFT-3-BL-L-S120-](#)
[M40A](#) [NLDFT-N-W-L-C240-M40B](#) [1926015-1](#) [NLS-N-W-C240-M40B](#) [2-1589900-8](#) [2199314-1](#) [KA8102](#) [9300480317](#) [29131](#) [294-0091-](#)
[01100](#) [296-0040-01100](#) [1648582-1](#) [A32595-0049](#) [1766249-1](#) [1766280-1](#) [1766818-1](#) [STV-H15S2-F/CO](#) [279-0841-10100A](#) [30-9717](#) [RMSB4](#)