

THIS DOCUMENT IS SUBJECT TO CHANGE WITHOUT NOTICE. IT IS CONFIDENTIAL AND A PROPERTY OF Amphenol LTW. DISCLOSURE TO THIRD PARTY HAS TO BE AUTHORIZED BY Amphenol LTW.

REV.	ECN NO.	DATE	SIGN	DESCRIPTION
C	LE313C0103	2013-12-16	Fisher	Change Plating and Package
D	CI91496	2019-08-29	NianPing Yu	Add UL Label
E	CI92063	2019-12-03	NianPing Yu	△E,XI

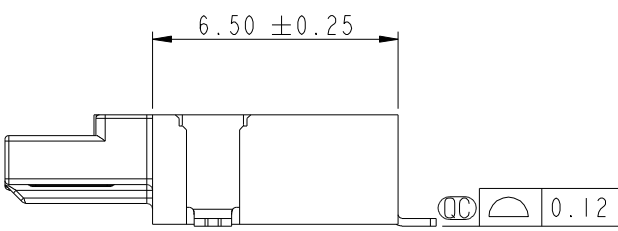

- Notes:
- * CC Important Dimension To Check.
 - * Housing: High temperature thermoplastic. UL94V-0, color is Natural white.
 - * Terminal: Copper Alloy, Gold Plated on contact area. Tin plated on solder tails.
 - * Solder Peg: Copper Alloy, Tin plated over Nickel.

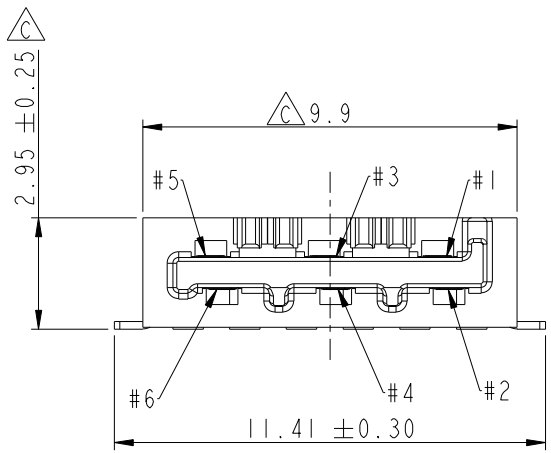
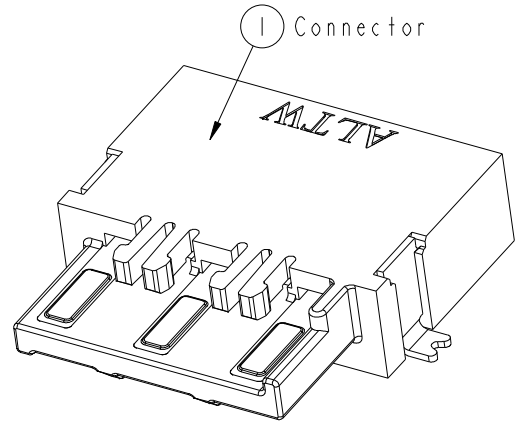
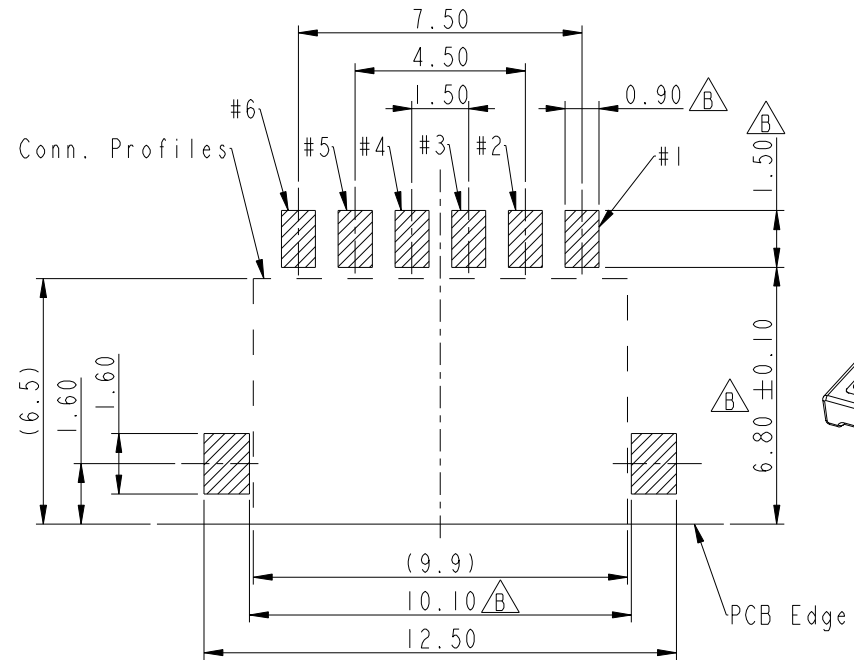
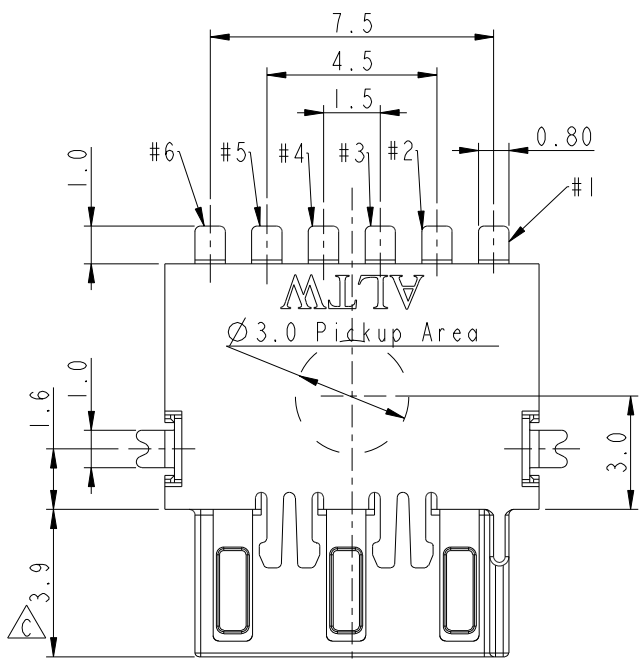
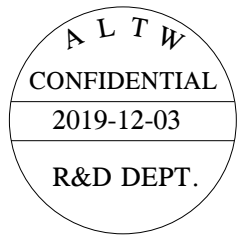

UNIT: mm

TOLERANCE	
.X	±0.25
.XX	±0.1
.XXX	±0.05
ANGLES	±1°

TITLE SSL-1.1 DC PLUG CONNECTOR 6-POS. W/O POST, SMT TYPE			
SCALE	SIZE	SHEET	OF
5:1	A4	1	2
REV.	WC-REV.	CC : Inspection item	
E	C.3		

Amphenol LTW
安費諾亮泰企業股份有限公司

ITEM NO	SSL11-P6D00-000001	DRAWN BY	NianPing Yu	DATE	2019-08-29
DWG NO	SSL11-P6D00-000001	CHECKED BY	Fisher Wang	DATE	2019-08-29
CUSTOMER	ALTW	APPROVED BY	Max Yang	DATE	2019-08-29

THIS DOCUMENT IS SUBJECT TO CHANGE WITHOUT NOTICE. IT IS CONFIDENTIAL AND A PROPERTY OF Amphenol LTW. DISCLOSURE TO THIRD PARTY HAS TO BE AUTHORIZED BY Amphenol LTW.

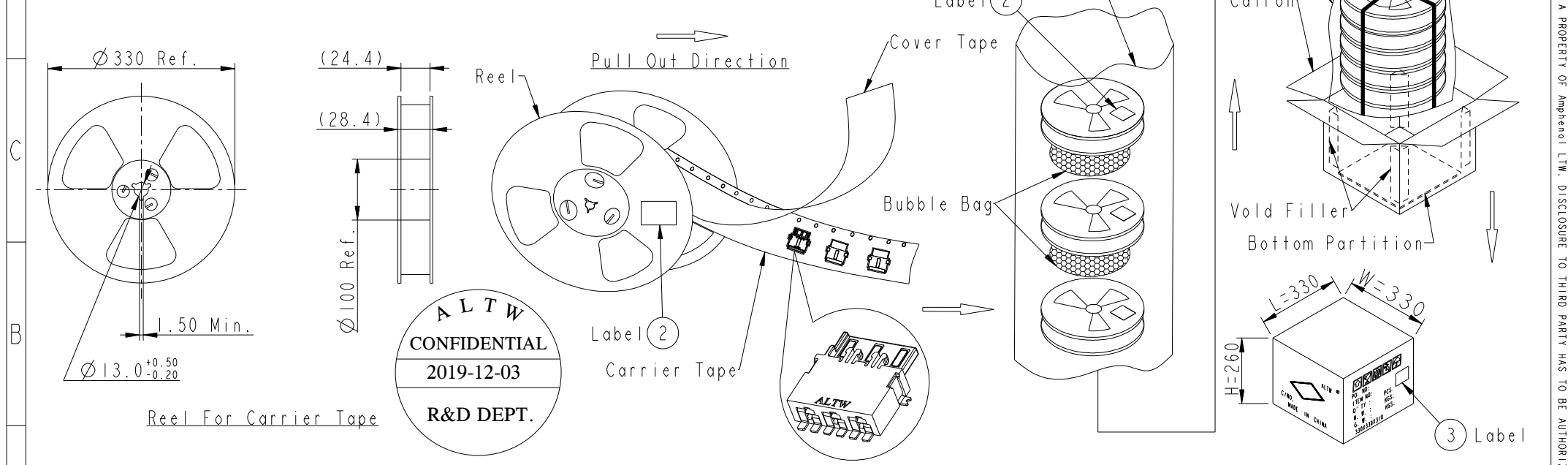
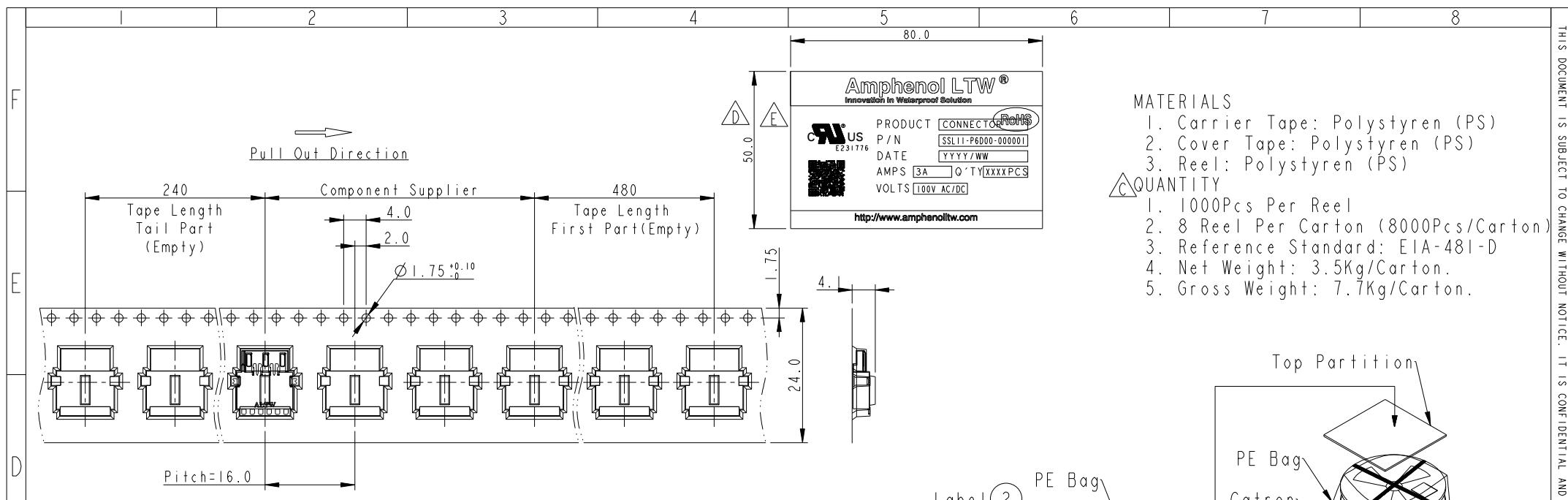

UNIT:mm TOLERANCE .X ±0.25 .XX ±0.1 .XXX ±0.05 ANGLES ±1°		TITLE SSL-1.1 DC PLUG CONNECTOR 6-POS. W/O POST, SMT TYPE		Amphenol LTW 安費諾亮泰企業股份有限公司	ITEM NO SSL11-P6D00-000001	DRAWN BY Fisher_Wang	DATE 2019-08-29
		SCALE 5:1	SIZE A4		SHEET 2 OF 2	DWG NO SSL11-P6D00-000001	CHECKED BY Ivan_Lin
		REV. E	WC-REV. A.5	QC : Inspection item	CUSTOMER ALTW	APPROVED BY Kevin_Hu	DATE 2019-08-29

X-ON Electronics

Largest Supplier of Electrical and Electronic Components

Click to view similar products for [Lighting Connectors](#) category:

Click to view products by [Amphenol](#) manufacturer:

Other Similar products are found below :

[21061-9](#) [293300-7](#) [2106117-2](#) [293660-5](#) [293700-2](#) [CNX_H03_NTP](#) [30-9767-BU](#) [3-21030-1](#) [ZCH-110-RGB-I](#) [503471-0290](#) [ES5P09K4F2](#)
[CNXH02NTP](#) [ZCH-110-RGB-J](#) [217-0716-200](#) [192992-0057](#) [1954563-1](#) [217-3030-000](#) [217-3032-000](#) [237-0734-003](#) [DTS24W25-20PN-LC](#)
[1-2213614-2](#) [2834049-3](#) [ES9S002SZZ](#) [2834049-2](#) [2-2834067-3](#) [1-293657-2](#) [2834049-1](#) [293699-2](#) [293701-3](#) [1-2213614-3](#) [2834036-1](#)
[2834037-1](#) [2213614-3](#) [2307526-2](#) [2-2106124-3](#) [2-2834068-3](#) [FLS2SC4001BP](#) [FLSC80352000](#) [FLSC80354000](#) [FLSC80353000](#) [FLSSB8002](#)
[FLSSB8001](#) [FLSC80351000](#) [FLSSB4001](#) [FLSC80504000](#) [FLSC80502000](#) [FLSC80501000](#) [FLSSR4001](#) [X3700WM-02HF-LPSN](#) [FLA-](#)
[R4142-30](#)