

C TJ-106HC

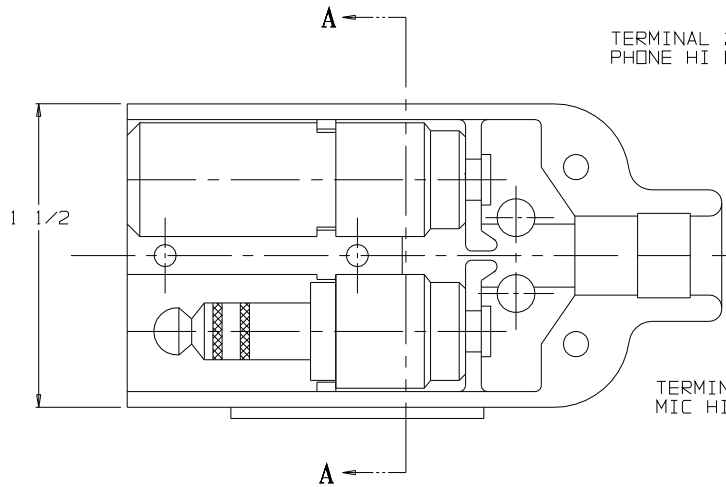

VIEW WITH HALF SHELL REMOVED

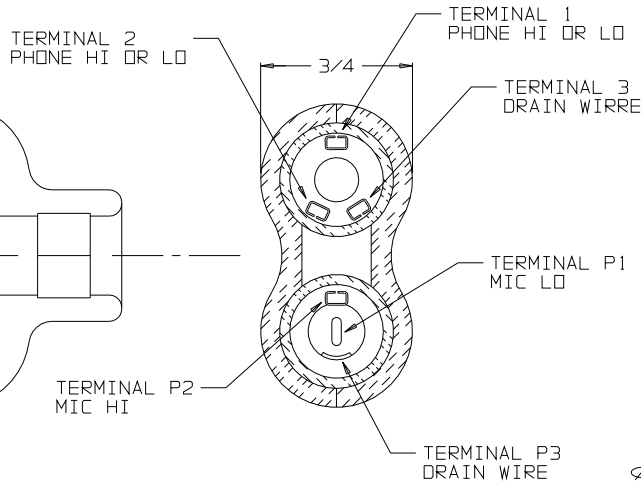

SECTION A-A

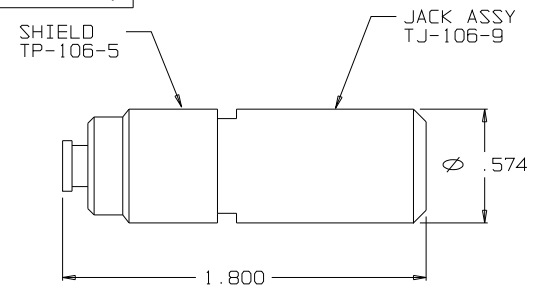

TJ-106-21 JACK & SHIELD ASSEMBLY

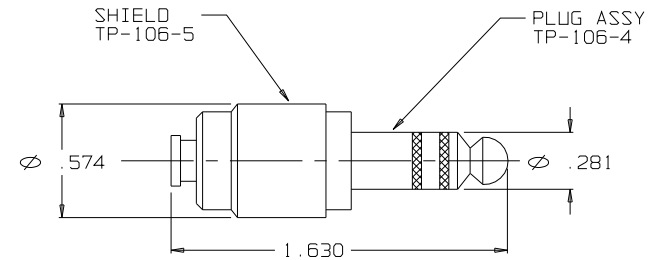

TP-106-10 PLUG & SHIELD ASSEMBLY

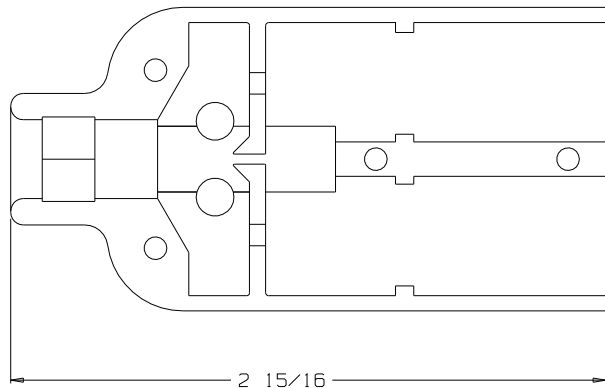

SHELL, HALF
TJ-106-11HC
(X2)

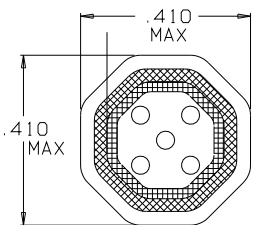

SECTION B-B

STRAIN RELIEF
CLAMP TJSS-106-12
AFTER CRIMPING
USE DANIELS HX4 CRIMP
TOOL AND Y146 DIE SET
SCALE 4:1

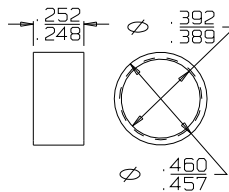

RING, STRAIN RELIEF
TJSS-106-12

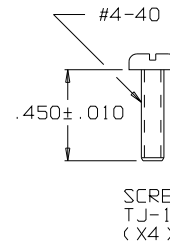
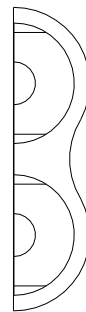

SCREW
TJ-106-12
(X4)

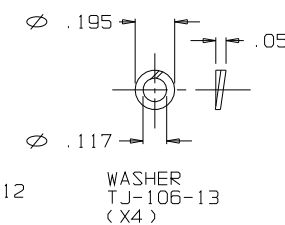

WASHER
TJ-106-13
(X4)

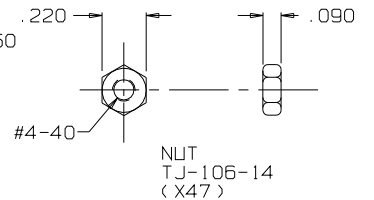

NUT
TJ-106-14
(X47)

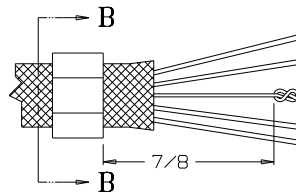

STAY CORD-VARNISH KNOT

THIS DOCUMENT CONTAINS PROPRIETARY INFORMATION OF NEXUS, INCORPORATED AND SUCH INFORMATION MAY NOT BE DISCLOSED TO OTHERS FOR ANY PURPOSE OR USED FOR ANY PURPOSE WITHOUT THE WRITTEN CONSENT OF NEXUS.

| | | | | |
|---|---|--------------------------------|-----------|---|
| OWN BY EWT | DATE 8/3/01 | MATERIAL | SCALE 2:1 | NEXUS STAMFORD, CONN. DWG. NO. TJ-106HC |
| CHECKED BY | DATE | FINISH | | |
| APPR. BY | DATE | WEIGHT | | TITLE JACK-TELEPHONE-BIAXIAL SHIELDED (6) CONDUCTOR HEX CRIMP |
| UNLESS OTHERWISE SPECIFIED DIMENSIONS ARE IN INCHES | | DO NOT SCALE DWG. SHEET 1 OF 1 | | |
| FRACTIONS DECIMALS ANGLES | | | | |
| LET. | REVISION | CN # | DATE | CHK. |
| B | ADD DANIELS HX4 CRIMP TOOL AND Y146 DIE SET | 026 | 9/16/09 | GPH |
| A | INITIAL RELEASE | | | |

X-ON Electronics

Largest Supplier of Electrical and Electronic Components

Click to view similar products for [Phone Connectors](#) category:

Click to view products by [Amphenol](#) manufacturer:

Other Similar products are found below :

[M444B](#) [6J1041A](#) [R4F](#) [E12BPKG](#) [ECP4PKG](#) [161-3502L-E](#) [MT333X](#) [171-0350-EX](#) [171-101A-EX](#) [171-3325-EX](#) [176S](#) [NC3MG-V](#)
[NYS228G](#) [P10834](#) [P2380](#) [P2381X](#) [P2411X](#) [P2412](#) [P2724](#) [JM2PB-AU BULK](#) [9144](#) [S2674](#) [280L](#) [163-156N-2-E](#) [163-158N-2-E](#) [171-3308-](#)
[EX](#) [171-3500-E](#) [2501FT](#) [CMT335](#) [M10662](#) [330Q](#) [RJ5VI-S](#) [40116](#) [TM1R-AU](#) [TM2PBMJ-AU](#) [TM2PJ-AU](#) [TM2PJ-AU BULK](#) [4803.1351](#)
[49201](#) [49205](#) [TS3PBJ-AU](#) [TS3PBMJ-AU](#) [TT32BX](#) [54B](#) [40112](#) [40205](#) [415](#) [XMT332B](#) [52170017-331](#) [570](#)