

TMM

TMM Series
1.27mm pitch



X	-X	-XX	-X
---	----	-----	----

- Type**
 1=IDC Male
 2=IDC Transition Plug
 3=DIP Male Straight
 4=DIP Female Straight
 5=DIP Female R/A
 6=SMT Female Straight

- Locking**
 L= with Lock
 0= w/o Lock

- No. of Positions**
 04= 04 Positions
 :
 :
 26= 26 Positions

- Packaging**
 1= Tape&Reel+cap
 2= Tube
 3= Bag
 4= Tape&Reel w/o cap

TMM-1
(IDC Male)

Circuits	Dimension	
	A	B
4	8.45	2.54
6	10.99	5.08
8	13.53	7.62
10	16.07	10.16
12	18.61	12.70
14	21.15	15.24
16	23.69	17.78
18	26.23	20.32
20	28.77	22.86
22	31.31	25.40
24	33.85	27.94
26	36.39	30.48

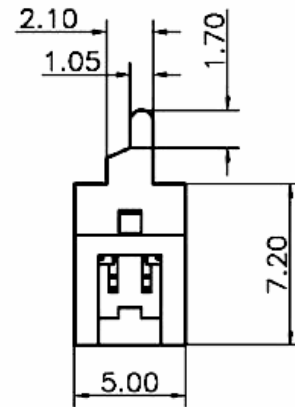
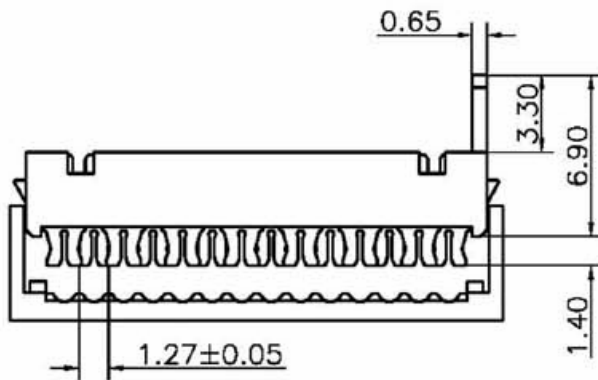
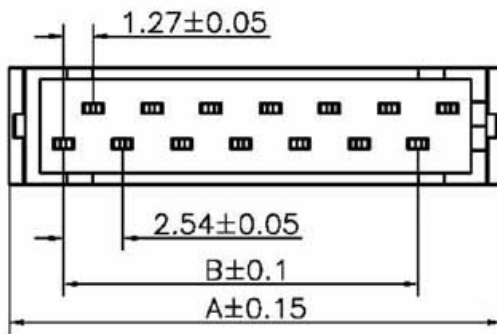

General Specification

Materials and Finish :

Insulator: Themoplastic, UL 94V-0, Color in Red
Contact : Phosphor Bronze, Tin plated.

Electrical :

Contact Resistance: 20 mΩ max. at 1A DC
Insulation Resistance: 1000 MΩ min, at 500 V/DC.
Dielectric Withstanding Voltage : 500 V AC/RMS 60Hz for one minute.
Current Rating : 1.5A max,
Voltage Rating : 230V AC/RMS 60Hz, DC

Environment:

Operating Temperature: -40 degree C to +105 degree C

TMM

TMM Series
1.27mm pitch



X	-X	-XX	-X
---	----	-----	----

Type

- 1=IDC Male
- 2=IDC Transition Plug
- 3=DIP Male Straight
- 4=DIP Female Straight
- 5=DIP Female R/A
- 6=SMT Female Straight

Locking

- L= with Lock
- 0= w/o Lock

No. of Positions

- 04= 04 Positions
- :
- :
- 26= 26Positions

Packaging

- 1= Tape&Reel+cap
- 2= Tube
- 3= Bag
- 4= Tape&Reel w/o cap

TMM-2
(IDC Plug)

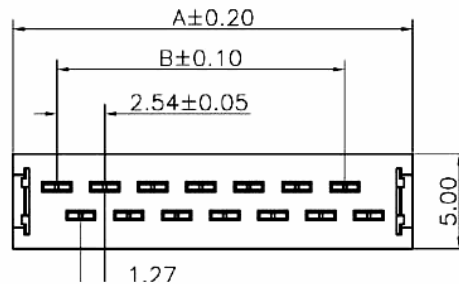

Circuits	Dimension	
	A	B
4	8.45	2.54
6	10.99	5.08
8	13.53	7.62
10	16.07	10.16
12	18.61	12.70
14	21.15	15.24
16	23.69	17.78
18	26.23	20.32
20	28.77	22.86
22	31.31	25.40
24	33.85	27.94
26	36.39	30.48

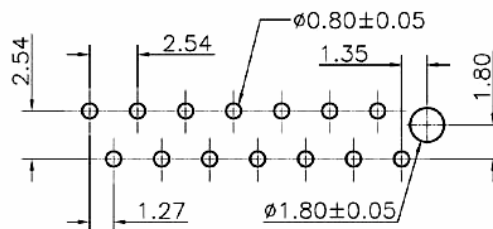
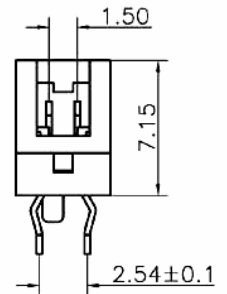
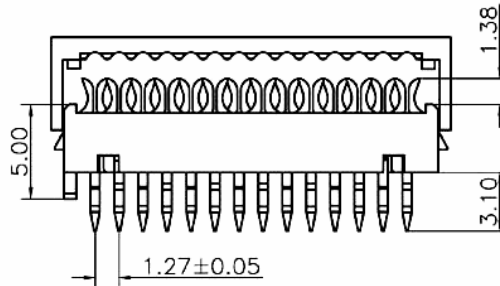

PCB Layout

General Specification

Materials and Finish :

Insulator: Themoplastic, UL 94V-0, Color in Red
Contact : Phosphor Bronze, Tin plated.

Electrical :

Contact Resistance: 20 mΩ max. at 1A DC
Insulation Resistance: 1000 MΩ min, at 500 V/DC.
Dielectric Withstanding Voltage : 500 V AC/RMS 60Hz for one minute.
Current Rating : 1.5 A max,
Voltage Rating : 230V AC/RMS 60Hz, DC

Environment :

Operating Temperature: -40 degree C to +105 degree C

TMM

TMM Series
1.27mm pitch

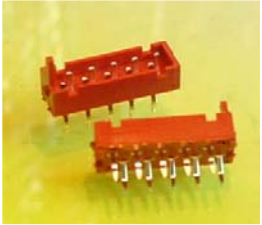

- X -X -XX -X

Type
 1=IDC Male
 2=IDC Transition Plug
 3=DIP Male Straight
 4=DIP Female Straight
 5=DIP Female R/A
 6=SMT Female Straight

Locking
 L= with Lock
 0= w/o Lock

No. of Positions
 04= 04 Positions
 :
 :
 26= 26 Positions

Packaging
 1= Tape&Reel+cap
 2= Tube
 3= Bag
 4= Tape&Reel w/o cap

TMM-3
(Dip Male ST)

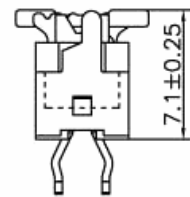
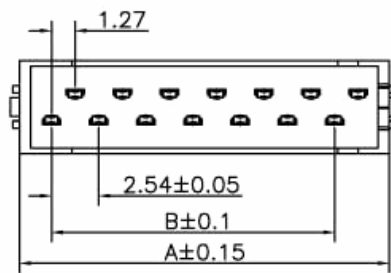

Mating Height Draw.

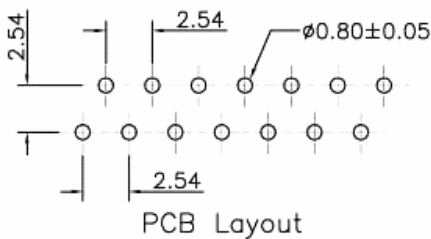
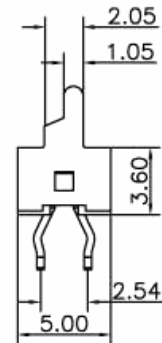
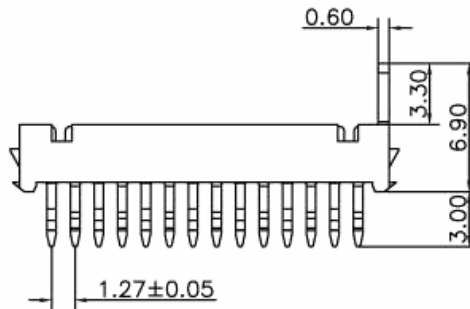

Circuits	Dimension		Circuits	Dimension		Circuits	Dimension	
	A	B		A	B		A	B
4	7.20	2.54	12	17.36	12.70	20	27.52	22.86
6	9.74	5.08	14	19.90	15.24	22	30.06	25.40
8	12.28	7.62	16	22.44	17.78	24	32.60	27.94
10	14.82	10.16	18	24.98	20.32	26	35.14	30.48

General Specification

Materials and Finish :

Insulator: Glass-reinforce thermoplastic, UL 94V-0, Nylon, Color in Red.
Contact : Phosphor Bronze, Tin plated.

Electrical :

Contact Resistance: 20 mΩ max. at 1.5A DC
Insulation Resistance: 1000 MΩ min, at 500 V/DC.
Dielectric Withstanding Voltage : 500 V AC/RMS 60Hz for one minute.
Current Rating : 1.5A max,
Voltage Rating : 230V AC/RMS 60Hz, DC

Environment :

Operating Temperature:
 -40 degree C to +105 degree C

TMM

TMM Series
1.27mm pitch

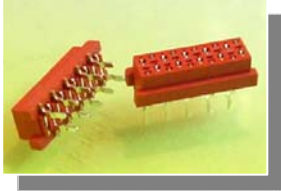

X	-X	-XX	-X
Type 1=IDC Male 2=IDC Transition Plug 3=DIP Male Straight 4=DIP Female Straight 5=DIP Female R/A 6=SMT Female Straight	Locking L= with Lock 0= w/o Lock	No. of Positions 04= 04 Positions : : 26= 26 Positions	Packaging 1= Tape&Reel+cap 2= Tube 3= Bag 4= Tape&Reel w/o cap

TMM-4-0
(Dip Female ST)

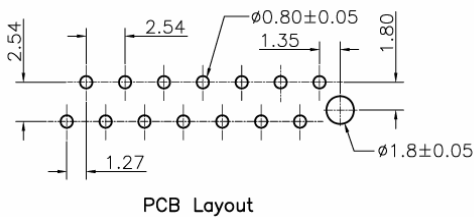
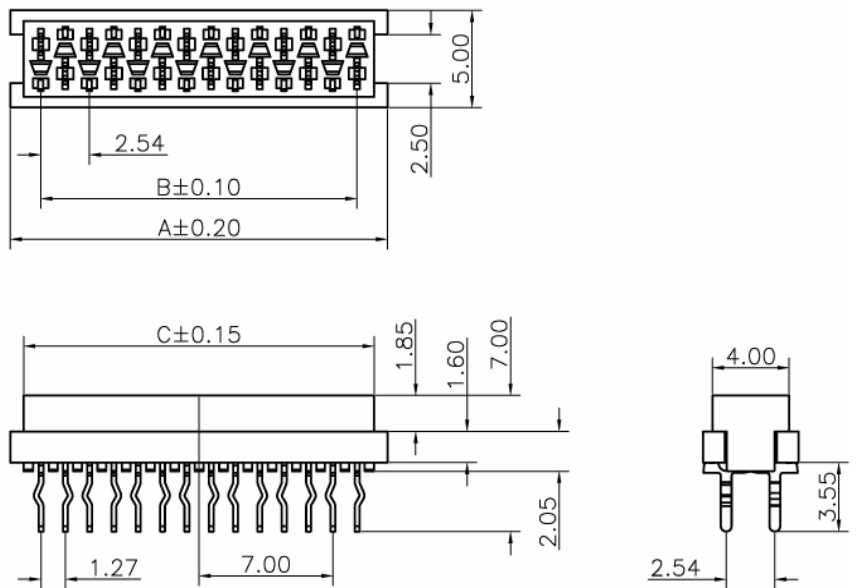

Pos	A	B	C	Pos	A	B	C
4	7.00	3.81	5.60	16	22.24	19.05	20.84
6	9.54	6.35	8.14	18	24.78	21.59	23.38
8	12.08	8.89	10.68	20	27.32	24.13	25.92
10	14.62	11.43	13.22	22	29.86	26.67	28.46
12	17.16	13.97	15.76	24	32.40	29.21	31.00
14	19.70	16.51	18.30	26	34.94	31.75	33.54

General Specification

<p>Materials and Finish :</p> <p>Insulator: Glass-reinforce thermo plastic, UL 94V-0, Nylon, Color in Red.</p> <p>Contact : Phosphor Bronze, Tin plated.</p>	<p>Electrical :</p> <p>Contact Resistance: 20 mΩ max. at 1A DC</p> <p>Insulation Resistance: 1000 MΩ min, at 500 V/DC.</p> <p>Dielectric Withstanding Voltage : 500 V AC/RMS 60Hz for one minute.</p> <p>Current Rating : 1.5A max.</p> <p>Voltage Rating : 230V AC/RMS 60Hz, DC</p>	<p>Envirement :</p> <p>Operating Temperature: -40 degree C to +105 degree C</p>
-----------------------------------------------------------------------------------------------------------------------------------------------------------------------------------	--------------------------------------------------------------------------------------------------------------------------------------------------------------------------------------------------------------------------------------------------------------------------------------------------------------------------------	-----------------------------------------------------------------------------------------------

TMM

TMM Series
1.27mm pitch

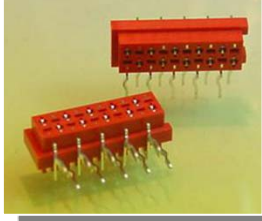

X	-X	-XX	-X
---	----	-----	----

Type 1=IDC Male 2=IDC Transition Plug 3=DIP Male Straight 4=DIP Female Straight 5=DIP Female R/A 6=SMT Female Straight	Locking L= with Lock 0= w/o Lock	No. of Positions 04= 04 Positions : : 26= 26 Positions	Packaging 1= Tape&Reel+cap 2= Tube 3= Bag 4= Tape&Reel w/o cap
-------------------------------------------------------------------------------------------------------------------------------------------------	-----------------------------------------------	---------------------------------------------------------------------------	-----------------------------------------------------------------------------------

TMM-5-0
(Dip Female R/A)

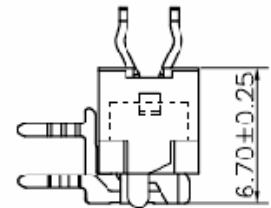
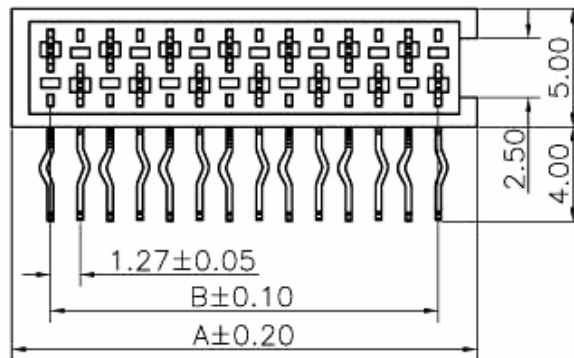

Mating Height Draw.

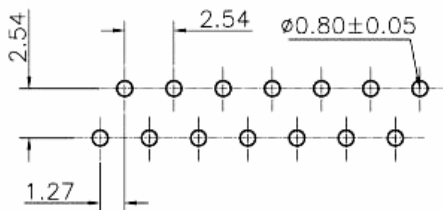
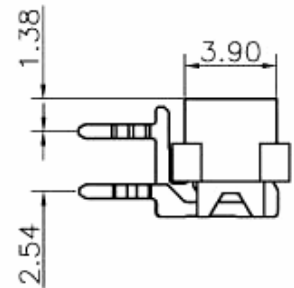
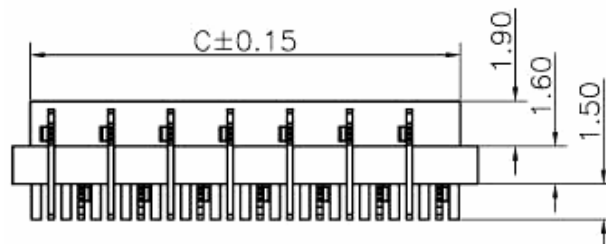

PCB Layout

Pos	A	B	C	Pos	A	B	C
4	7.00	3.81	5.60	16	22.24	19.05	20.84
6	9.54	6.35	8.14	18	24.78	21.59	23.38
8	12.08	8.89	10.68	20	27.32	24.13	25.92
10	14.62	11.43	13.22	22	29.86	26.67	28.46
12	17.16	13.97	15.76	24	32.40	29.21	31.00
14	19.70	16.51	18.30	26	34.94	31.75	33.54

General Specification

Materials and Finish : Insulator: Glass-reinforce thermo plastic, UL 94V-0, Nylon, Color in Red. Contact : Phosphor Bronze, Tin plated.	Electrical : Contact Resistance: 20 mΩ max. at 1A DC Insulation Resistance: 1000 MΩ min, at 500 V/DC. Dielectric Withstanding Voltage : 500 V AC/RMS 60Hz for one minute. Current Rating : 1.5A max Voltage Rating : 230V AC/RMS 60Hz, DC	Environment : Operating Temperature: -40 degree C to +105 degree C
------------------------------------------------------------------------------------------------------------------------------------------------------------------------	--------------------------------------------------------------------------------------------------------------------------------------------------------------------------------------------------------------------------------------------------------------------------------------------------------	--------------------------------------------------------------------------------------------

TMM

TMM Series
1.27mm pitch

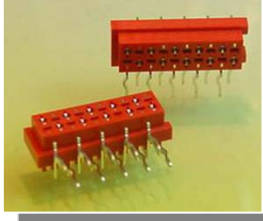

X	-X	-XX	-X
Type	Locking	No. of Positions	Packaging
1=IDC Male	L= with Lock	04= 04 Positions	1= Tape&Reel+cap
2=IDC Transition Plug	0= w/o Lock	:	2= Tube
3=DIP Male Straight		:	3= Bag
4=DIP Female Straight		26= 26 Positions	4= Tape&Reel w/o cap
5=DIP Female R/A			
6=SMT Female Straight			

TMM-5-L
(Dip Female R/A, w/ Lock)

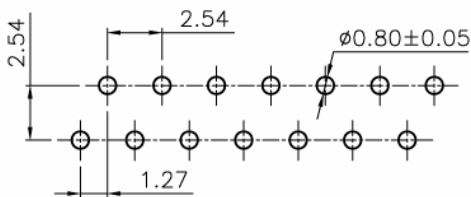
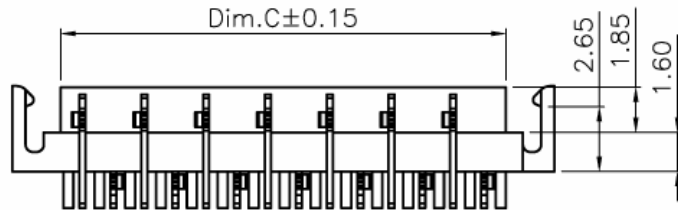
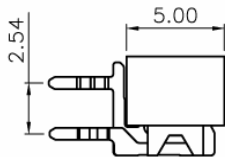
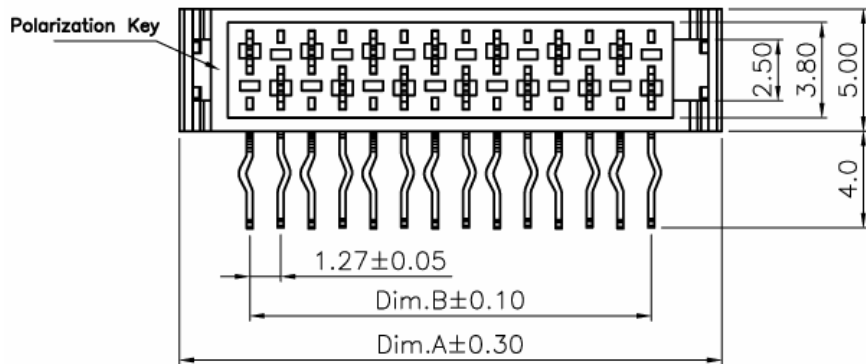

PCB Layout

Pos	Dim.A	Dim.B	Dim.C	Pos	Dim.A	Dim.B	Dim.C
4	9.70	3.81	5.60	16	24.94	19.05	20.84
6	12.24	6.35	8.14	18	27.48	21.59	23.38
8	14.78	8.89	10.68	20	30.02	24.13	25.92
10	17.32	11.43	13.22	22	32.56	26.67	28.46
12	19.86	13.97	15.76	24	35.10	29.21	31.00
14	22.40	16.51	18.30	26	37.64	31.75	33.54

General Specification

<p>Materials and Finish :</p> <p>Insulator: Glass-reinforce thermo plastic, UL 94V-0, Nylon, Color in Red.</p> <p>Contact : Phosphor Bronze, Tin plated.</p>	<p>Electrical :</p> <p>Contact Resistance: 20 mΩ max. at 1A DC</p> <p>Insulation Resistance: 1000 MΩ min, at 500 V/DC.</p> <p>Dielectric Withstanding Voltage : 500 V AC/RMS 60Hz for one minute.</p> <p>Current Rating : 1.5A max,</p> <p>Voltage Rating : 230V AC/RMS 60Hz, DC</p>	<p>Environment :</p> <p>Operating Temperature: -40 degree C to +105 degree C</p>
-----------------------------------------------------------------------------------------------------------------------------------------------------------------------------------	--------------------------------------------------------------------------------------------------------------------------------------------------------------------------------------------------------------------------------------------------------------------------------------------------------------------------------	------------------------------------------------------------------------------------------------

TMM

TMM Series
1.27mm pitch

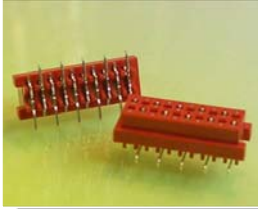

X	-X	-XX	-X
----------	-----------	------------	-----------

- | | | | |
|-------------------------------------------------------------------------------------------------------------------------------------------------------------------------------------------------------------------------------------|-----------------------------------------------------------------------------------------------------------|---------------------------------------------------------------------------------------------------------------------------------------------------|-------------------------------------------------------------------------------------------------------------------------------------------------------------------|
| <p>Type</p> <ul style="list-style-type: none"> 1=IDC Male 2=IDC Transition Plug 3=DIP Male Straight 4=DIP Female Straight 5=DIP Female R/A 6=SMT Female Straight | <p>Locking</p> <ul style="list-style-type: none"> L= with Lock 0= w/o Lock | <p>No. of Positions</p> <ul style="list-style-type: none"> 04= 04 Positions : : 26= 26 Positions | <p>Packaging</p> <ul style="list-style-type: none"> 1= Tape&Reel+cap 2= Tube 3= Bag 4= Tape&Reel w/o cap |
|-------------------------------------------------------------------------------------------------------------------------------------------------------------------------------------------------------------------------------------|-----------------------------------------------------------------------------------------------------------|---------------------------------------------------------------------------------------------------------------------------------------------------|-------------------------------------------------------------------------------------------------------------------------------------------------------------------|

TMM-6-0
(SMT Female ST)

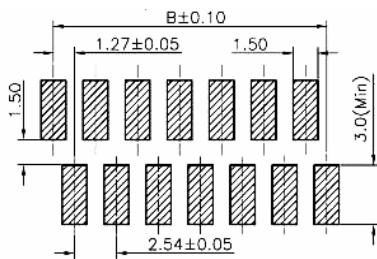
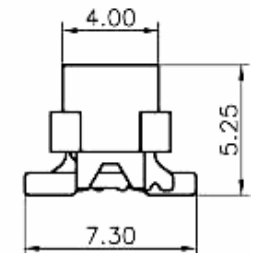
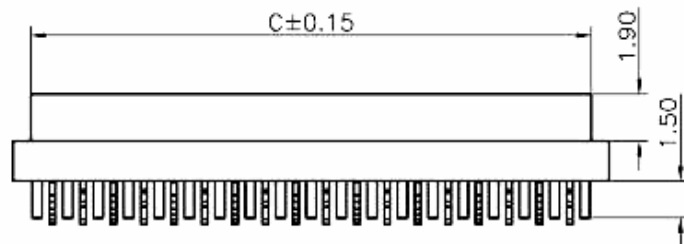
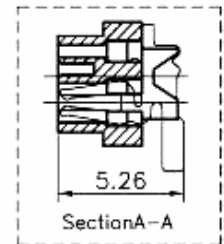
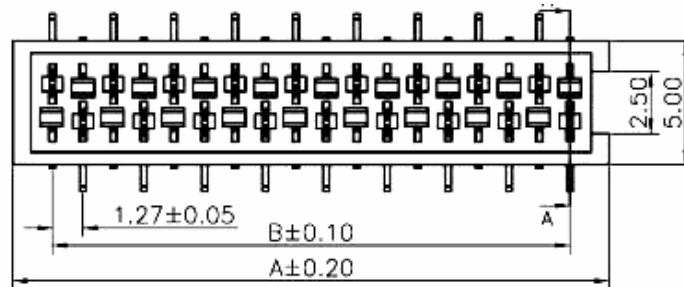

PCB Layout

Pos	A	B	C	Pos	A	B	C
4	7.00	3.81	5.60	16	22.24	19.05	20.84
6	9.54	6.35	8.14	18	24.78	21.59	23.38
8	12.08	8.89	10.68	20	27.32	24.13	25.92
10	14.62	11.43	13.22	22	29.86	26.67	28.46
12	17.16	13.97	15.76	24	32.40	29.21	31.00
14	19.70	16.51	18.30	26	34.94	31.75	33.54

General Specification

<p>Materials and Finish :</p> <p>Insulator: Glass-reinforce thermo plastic, UL 94V-0, Nylon, Color in Red</p> <p>Contact : Phosphor Bronze, Tin plated.</p>	<p>Electrical :</p> <p>Contact Resistance: 20 mΩ max. at 1A DC</p> <p>Insulation Resistance: 1000 MΩ min, at 500 V/DC.</p> <p>Dielectric Withstanding Voltage : 500 V AC/RMS 60Hz for one minute.</p> <p>Current Rating : 1.5 A max</p> <p>Voltage Rating : 230V AC/RMS 60Hz, DC</p>	<p>Environment :</p> <p>Operating Temperature: -40 degree C to +105 degree C</p>
----------------------------------------------------------------------------------------------------------------------------------------------------------------------------------	--------------------------------------------------------------------------------------------------------------------------------------------------------------------------------------------------------------------------------------------------------------------------------------------------------------------------------	------------------------------------------------------------------------------------------------

TMM

TMM Series
1.27mm pitch

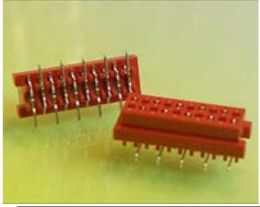

X	-X	-XX	-X
---	----	-----	----

Type	Locking	No. of Positions	Packaging
1=IDC Male	L= with Lock	04= 04 Positions	1= Tape&Reel+cap
2=IDC Transition Plug	0= w/o Lock	:	2= Tube
3=DIP Male Straight		:	3= Bag
4=DIP Female Straight		26= 26 Positions	4= Tape&Reel w/o cap
5=DIP Female R/A			
6=SMT Female Straight			

TMM-6-L
(SMT Female ST w/lock)

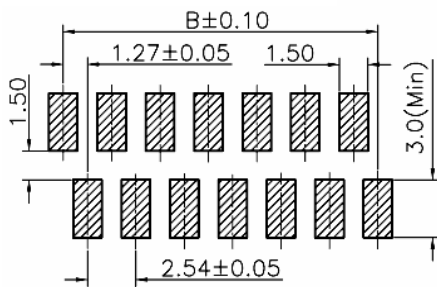
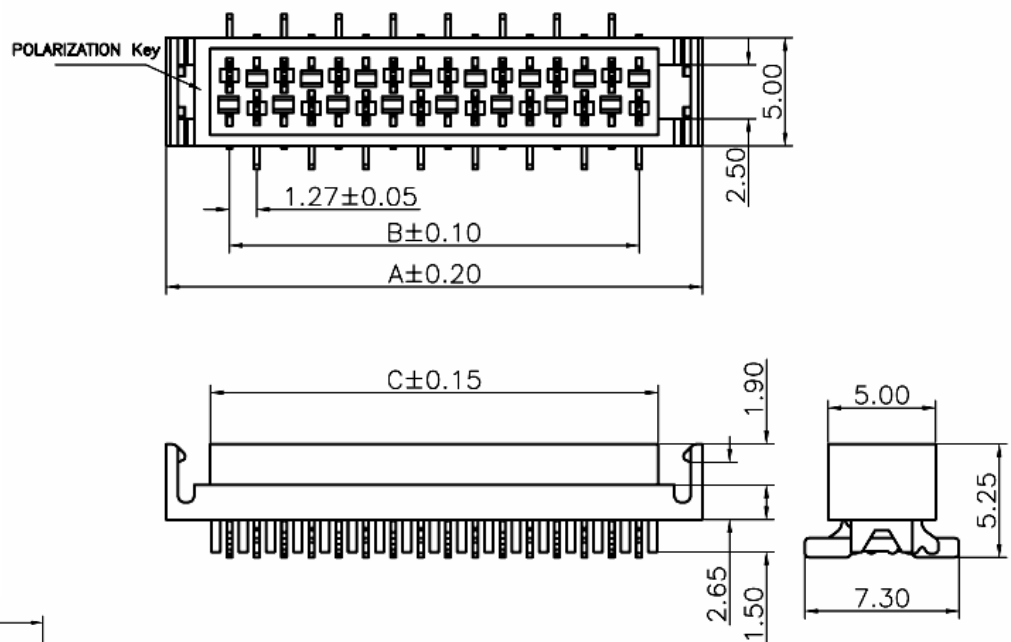

PCB Layout

Pos	A	B	C	Pos	A	B	C
4	9.70	3.81	5.60	16	24.94	19.05	20.84
6	12.24	6.35	8.14	18	27.48	21.59	23.38
8	14.78	8.89	10.68	20	30.02	24.13	25.92
10	17.32	11.43	13.22	22	32.56	26.67	28.46
12	19.86	13.97	15.76	24	35.10	29.21	31.00
14	22.40	16.51	18.30	26	37.64	31.75	33.54

General Specification

<p>Materials and Finish :</p> <p>Insulator: Glass-reinforce thermo plastic, UL 94V-0, Nylon, Color in Red.</p> <p>Contact : Phosphor Bronze, Tin plated.</p>	<p>Electrical :</p> <p>Contact Resistance: 20 mΩ max. at 1A DC</p> <p>Insulation Resistance: 1000 MΩ min, at 500 V/DC.</p> <p>Dielectric Withstanding Voltage : 500 V AC/RMS 60Hz for one minute.</p> <p>Current Rating : 1.5A max,</p> <p>Voltage Rating : 230V AC/RMS 60Hz, DC</p>	<p>Environment :</p> <p>Operating Temperature: -40 degree C to +105 degree C</p>
-----------------------------------------------------------------------------------------------------------------------------------------------------------------------------------	--------------------------------------------------------------------------------------------------------------------------------------------------------------------------------------------------------------------------------------------------------------------------------------------------------------------------------	------------------------------------------------------------------------------------------------

X-ON Electronics

Largest Supplier of Electrical and Electronic Components

Click to view similar products for [Headers & Wire Housings](#) category:

Click to view products by [Amphenol](#) manufacturer:

Other Similar products are found below :

[95000-104TRLF](#) [10135584-644402LF](#) [DF62W-EP2022PCA](#) [95000-106TRLF](#) [DF62W-2022SCA](#) [DF62W-EP2022PC](#) [2203348](#) [DF62W-2022SC](#) [1084018](#) [1029039](#) [1084017](#) [802-10-012-10-002000](#) [1112640](#) [1112639](#) [000-34000](#) [0009482033](#) [0009507031](#) [57102-S06-03LF](#) [57202-S52-04LF](#) [PCN6-15S-2.5E](#) [0039019024](#) [58102-G61-06LF](#) [582553-1](#) [0009485154](#) [0009508121](#) [0022285053](#) [0050291907](#) [018731A](#) [LY20-4P-DT1-P1E-BR](#) [02.125.8002.8](#) [60101931](#) [60598-1 \(Cut Strip\)](#) [M1625-3R/100](#) [61062-3](#) [61082-181009](#) [636-1427](#) [638009-1](#) [641938-9](#) [641991-4](#) [644168-1](#) [647662-1](#) [65039-019ELF](#) [65781-047](#) [65817-002LF](#) [65817-015LF](#) [65863-015LF](#) [66207-023LF](#) [67016-026LF](#) [67046-001LF](#) [67095-007LF](#)