

TMM

TMM Series  
1.27mm pitch



X	-X	-XX	-X
---	----	-----	----

- Type**  
 1=IDC Male  
 2=IDC Transition Plug  
 3=DIP Male Straight  
 4=DIP Female Straight  
 5=DIP Female R/A  
 6=SMT Female Straight

- Locking**  
 L= with Lock  
 0= w/o Lock

- No. of Positions**  
 04= 04 Positions  
 :  
 :  
 26= 26 Positions

- Packaging**  
 1= Tape&Reel+cap  
 2= Tube  
 3= Bag  
 4= Tape&Reel w/o cap

**TMM-1**  
(IDC Male)

Circuits	Dimension	
	A	B
4	8.45	2.54
6	10.99	5.08
8	13.53	7.62
10	16.07	10.16
12	18.61	12.70
14	21.15	15.24
16	23.69	17.78
18	26.23	20.32
20	28.77	22.86
22	31.31	25.40
24	33.85	27.94
26	36.39	30.48

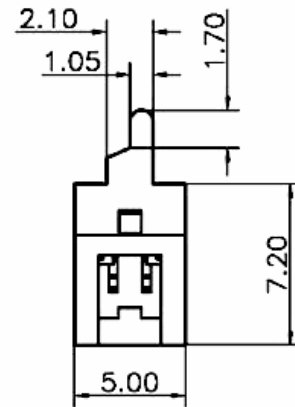
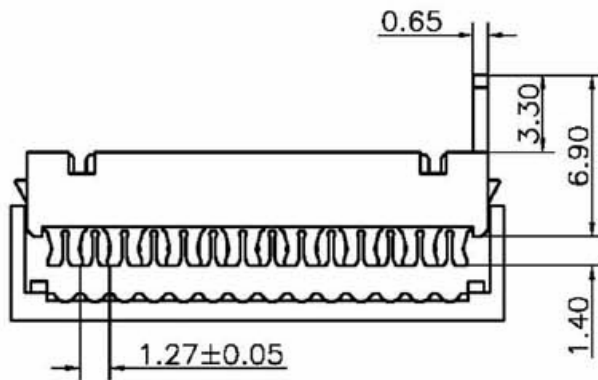
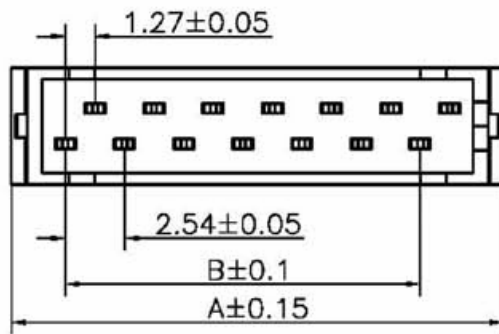

**General Specification**

**Materials and Finish :**

**Insulator:** Themoplastic, UL 94V-0, Color in Red  
**Contact :** Phosphor Bronze, Tin plated.

**Electrical :**

**Contact Resistance:** 20 mΩ max. at 1A DC  
**Insulation Resistance:** 1000 MΩ min, at 500 V/DC.  
**Dielectric Withstanding Voltage :** 500 V AC/RMS 60Hz for one minute.  
**Current Rating :** 1.5A max,  
**Voltage Rating :** 230V AC/RMS 60Hz, DC

**Environment:**

**Operating Temperature:** -40 degree C to +105 degree C

TMM

TMM Series  
1.27mm pitch



X	-X	-XX	-X
---	----	-----	----

Type

- 1=IDC Male
- 2=IDC Transition Plug
- 3=DIP Male Straight
- 4=DIP Female Straight
- 5=DIP Female R/A
- 6=SMT Female Straight

Locking

- L= with Lock
- 0= w/o Lock

No. of Positions

- 04= 04 Positions
- :
- :
- 26= 26Positions

Packaging

- 1= Tape&Reel+cap
- 2= Tube
- 3= Bag
- 4= Tape&Reel w/o cap

TMM-2  
(IDC Plug)

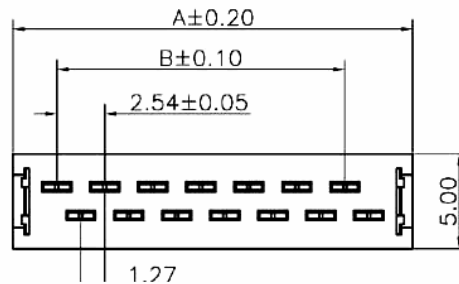

Circuits	Dimension	
	A	B
4	8.45	2.54
6	10.99	5.08
8	13.53	7.62
10	16.07	10.16
12	18.61	12.70
14	21.15	15.24
16	23.69	17.78
18	26.23	20.32
20	28.77	22.86
22	31.31	25.40
24	33.85	27.94
26	36.39	30.48

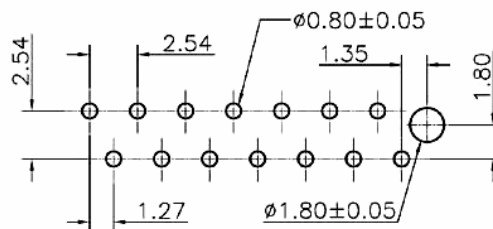
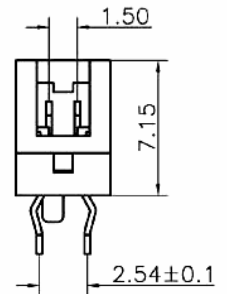
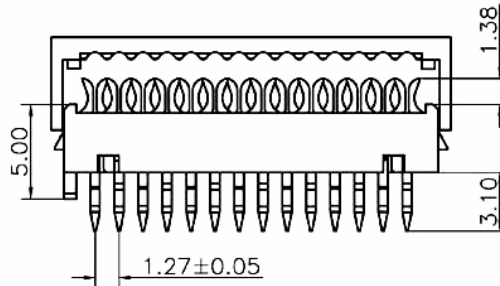

PCB Layout

General Specification

Materials and Finish :

**Insulator:** Themoplastic, UL 94V-0, Color in Red  
**Contact :** Phosphor Bronze, Tin plated.

Electrical :

**Contact Resistance:** 20 mΩ max. at 1A DC  
**Insulation Resistance:** 1000 MΩ min, at 500 V/DC.  
**Dielectric Withstanding Voltage :** 500 V AC/RMS 60Hz for one minute.  
**Current Rating :** 1.5 A max,  
**Voltage Rating :** 230V AC/RMS 60Hz, DC

Environment :

**Operating Temperature:** -40 degree C to +105 degree C

TMM

TMM Series  
1.27mm pitch

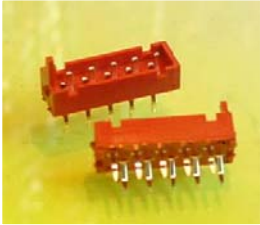

- X -X -XX -X

**Type**  
 1=IDC Male  
 2=IDC Transition Plug  
 3=DIP Male Straight  
 4=DIP Female Straight  
 5=DIP Female R/A  
 6=SMT Female Straight

**Locking**  
 L= with Lock  
 0= w/o Lock

**No. of Positions**  
 04= 04 Positions  
 :  
 :  
 26= 26 Positions

**Packaging**  
 1= Tape&Reel+cap  
 2= Tube  
 3= Bag  
 4= Tape&Reel w/o cap

TMM-3  
(Dip Male ST)

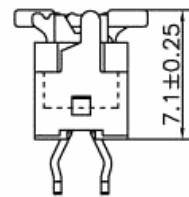
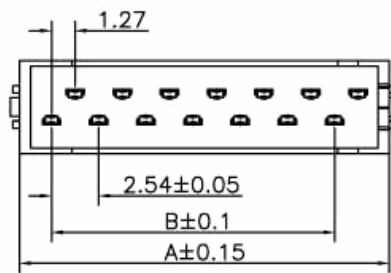

Mating Height Draw.

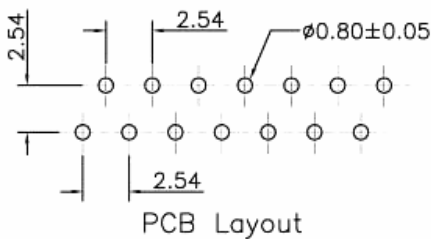
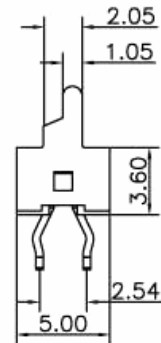
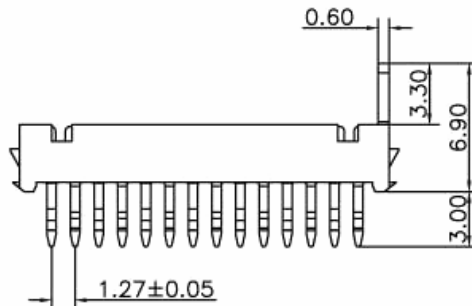

Circuits	Dimension		Circuits	Dimension		Circuits	Dimension	
	A	B		A	B		A	B
4	7.20	2.54	12	17.36	12.70	20	27.52	22.86
6	9.74	5.08	14	19.90	15.24	22	30.06	25.40
8	12.28	7.62	16	22.44	17.78	24	32.60	27.94
10	14.82	10.16	18	24.98	20.32	26	35.14	30.48

General Specification

Materials and Finish :

**Insulator:** Glass-reinforce thermoplastic, UL 94V-0, Nylon, Color in Red.  
**Contact :** Phosphor Bronze, Tin plated.

Electrical :

**Contact Resistance:** 20 mΩ max. at 1.5A DC  
**Insulation Resistance:** 1000 MΩ min, at 500 V/DC.  
**Dielectric Withstanding Voltage :** 500 V AC/RMS 60Hz for one minute.  
**Current Rating :** 1.5A max,  
**Voltage Rating :** 230V AC/RMS 60Hz, DC

Environment :

**Operating Temperature:**  
 -40 degree C to +105 degree C

TMM

TMM Series  
1.27mm pitch

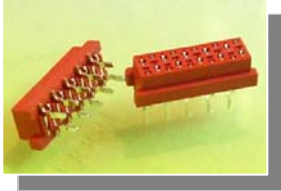

X	-X	-XX	-X
<b>Type</b> 1=IDC Male 2=IDC Transition Plug 3=DIP Male Straight 4=DIP Female Straight 5=DIP Female R/A 6=SMT Female Straight	<b>Locking</b> L= with Lock 0= w/o Lock	<b>No. of Positions</b> 04= 04 Positions : : 26= 26 Positions	<b>Packaging</b> 1= Tape&Reel+cap 2= Tube 3= Bag 4= Tape&Reel w/o cap

**TMM-4-0**  
(Dip Female ST)

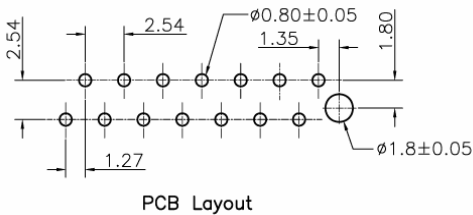
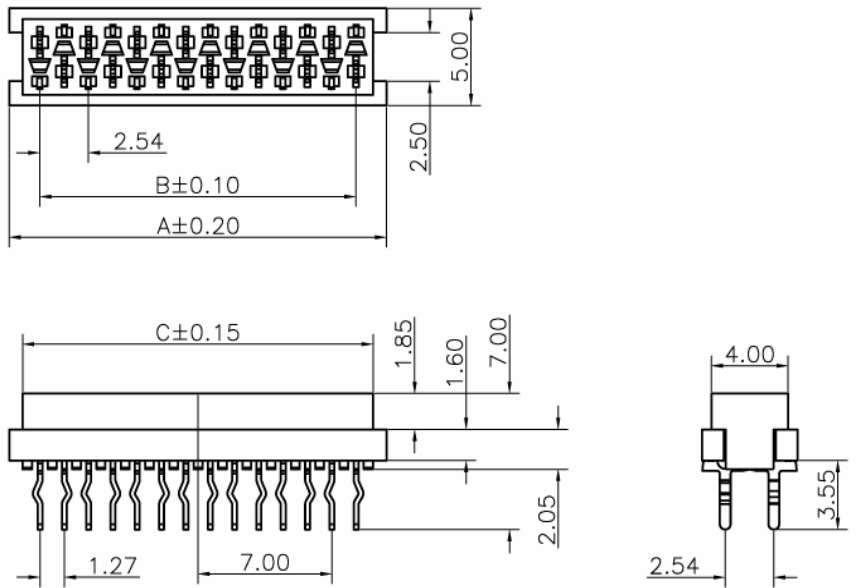

Pos	A	B	C	Pos	A	B	C
4	7.00	3.81	5.60	16	22.24	19.05	20.84
6	9.54	6.35	8.14	18	24.78	21.59	23.38
8	12.08	8.89	10.68	20	27.32	24.13	25.92
10	14.62	11.43	13.22	22	29.86	26.67	28.46
12	17.16	13.97	15.76	24	32.40	29.21	31.00
14	19.70	16.51	18.30	26	34.94	31.75	33.54

**General Specification**

<p><b>Materials and Finish :</b></p> <p><b>Insulator:</b> Glass-reinforce thermo plastic, UL 94V-0, Nylon, Color in Red.</p> <p><b>Contact :</b> Phosphor Bronze, Tin plated.</p>	<p><b>Electrical :</b></p> <p><b>Contact Resistance:</b> 20 mΩ max. at 1A DC</p> <p><b>Insulation Resistance:</b> 1000 MΩ min, at 500 V/DC.</p> <p><b>Dielectric Withstanding Voltage :</b> 500 V AC/RMS 60Hz for one minute.</p> <p><b>Current Rating :</b> 1.5A max.</p> <p><b>Voltage Rating :</b> 230V AC/RMS 60Hz, DC</p>	<p><b>Envirement :</b></p> <p><b>Operating Temperature:</b> -40 degree C to +105 degree C</p>
---	--	---

TMM

TMM Series  
1.27mm pitch

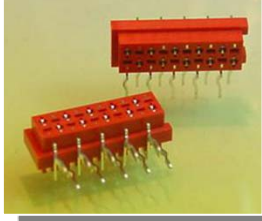

- X -X -XX -X

Type

- 1=IDC Male
- 2=IDC Transition Plug
- 3=DIP Male Straight
- 4=DIP Female Straight
- 5=DIP Female R/A
- 6=SMT Female Straight

Locking

- L= with Lock
- 0= w/o Lock

No. of Positions

- 04= 04 Positions
- :
- :
- 26= 26 Positions

Packaging

- 1= Tape&Reel+cap
- 2= Tube
- 3= Bag
- 4= Tape&Reel w/o cap

TMM-5-0

(Dip Female R/A)

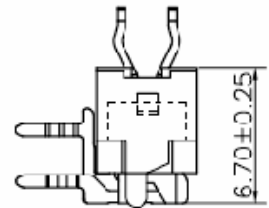
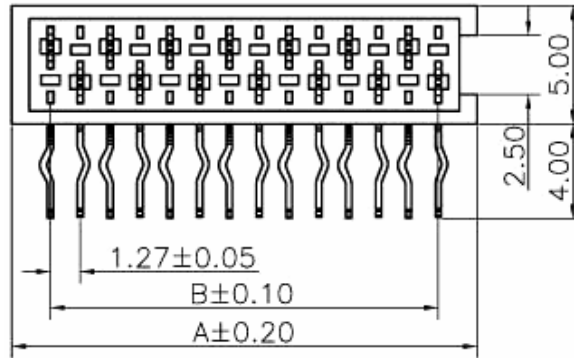

Mating Height Draw.

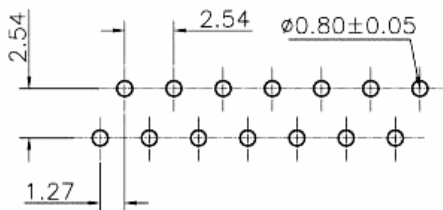
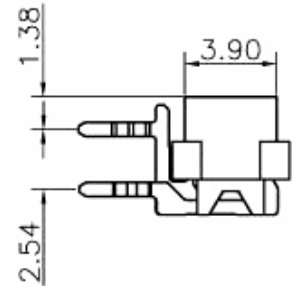
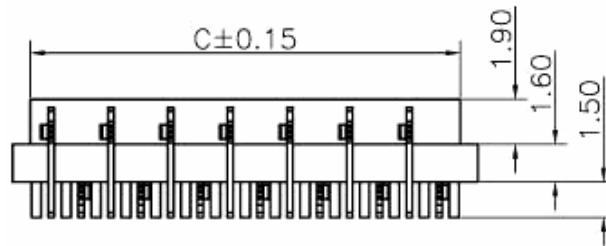

PCB Layout

Pos	A	B	C	Pos	A	B	C
4	7.00	3.81	5.60	16	22.24	19.05	20.84
6	9.54	6.35	8.14	18	24.78	21.59	23.38
8	12.08	8.89	10.68	20	27.32	24.13	25.92
10	14.62	11.43	13.22	22	29.86	26.67	28.46
12	17.16	13.97	15.76	24	32.40	29.21	31.00
14	19.70	16.51	18.30	26	34.94	31.75	33.54

General Specification

Materials and Finish :

**Insulator:** Glass-reinforce thermo plastic, UL 94V-0, Nylon, Color in Red.

**Contact :** Phosphor Bronze, Tin plated.

Electrical :

**Contact Resistance:** 20 mΩ max. at 1A DC

**Insulation Resistance:** 1000 MΩ min, at 500 V/DC.

**Dielectric Withstanding Voltage :** 500 V AC/RMS 60Hz for one minute.

**Current Rating :** 1.5A max

**Voltage Rating :** 230V AC/RMS 60Hz, DC

Environment :

**Operating Temperature:** -40 degree C to +105 degree C

TMM

TMM Series  
1.27mm pitch

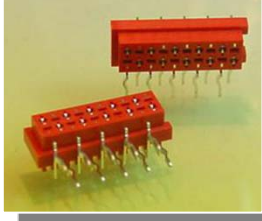

Type

- 1=IDC Male
- 2=IDC Transition Plug
- 3=DIP Male Straight
- 4=DIP Female Straight
- 5=DIP Female R/A
- 6=SMT Female Straight

Locking

- L= with Lock
- 0= w/o Lock

No. of Positions

- 04= 04 Positions
- :
- :
- 26= 26 Positions

Packaging

- 1= Tape&Reel+cap
- 2= Tube
- 3= Bag
- 4= Tape&Reel w/o cap

TMM-5-L

(Dip Female R/A, w/ Lock)

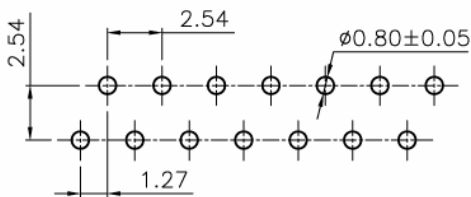
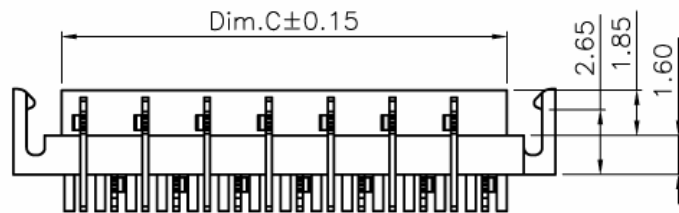
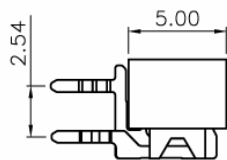
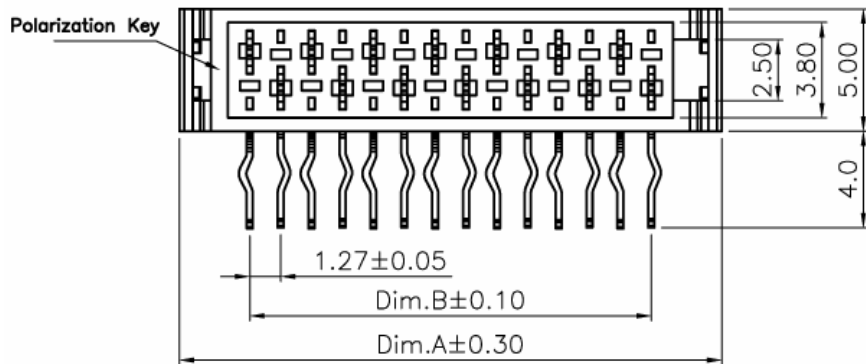

PCB Layout

Pos	Dim.A	Dim.B	Dim.C	Pos	Dim.A	Dim.B	Dim.C
4	9.70	3.81	5.60	16	24.94	19.05	20.84
6	12.24	6.35	8.14	18	27.48	21.59	23.38
8	14.78	8.89	10.68	20	30.02	24.13	25.92
10	17.32	11.43	13.22	22	32.56	26.67	28.46
12	19.86	13.97	15.76	24	35.10	29.21	31.00
14	22.40	16.51	18.30	26	37.64	31.75	33.54

General Specification

Materials and Finish :

**Insulator:** Glass-reinforce thermo plastic, UL 94V-0, Nylon, Color in Red.  
**Contact :** Phosphor Bronze, Tin plated.

Electrical :

**Contact Resistance:** 20 mΩ max. at 1A DC  
**Insulation Resistance:** 1000 MΩ min, at 500 V/DC.  
**Dielectric Withstanding Voltage :** 500 V AC/RMS 60Hz for one minute.  
**Current Rating :** 1.5A max,  
**Voltage Rating :** 230V AC/RMS 60Hz, DC

Environment :

**Operating Temperature:**  
-40 degree C to +105 degree C



**TMM**

TMM Series  
1.27mm pitch

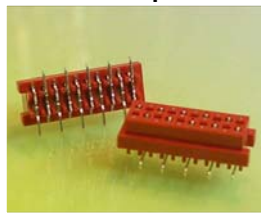

<b>X</b>	<b>-X</b>	<b>-XX</b>	<b>-X</b>
----------	-----------	------------	-----------

- |   |   |   |   |
|---|---|---|---|
| <p><b>Type</b></p> <ul style="list-style-type: none"> <li>1=IDC Male</li> <li>2=IDC Transition Plug</li> <li>3=DIP Male Straight</li> <li>4=DIP Female Straight</li> <li>5=DIP Female R/A</li> <li>6=SMT Female Straight</li> </ul> | <p><b>Locking</b></p> <ul style="list-style-type: none"> <li>L= with Lock</li> <li>0= w/o Lock</li> </ul> | <p><b>No. of Positions</b></p> <ul style="list-style-type: none"> <li>04= 04 Positions</li> <li>:</li> <li>:</li> <li>26= 26 Positions</li> </ul> | <p><b>Packaging</b></p> <ul style="list-style-type: none"> <li>1= Tape&amp;Reel+cap</li> <li>2= Tube</li> <li>3= Bag</li> <li>4= Tape&amp;Reel w/o cap</li> </ul> |
|---|---|---|---|

**TMM-6-0**  
(SMT Female ST)

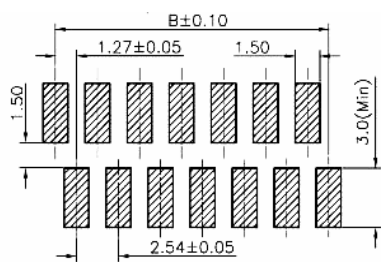
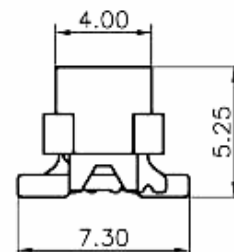
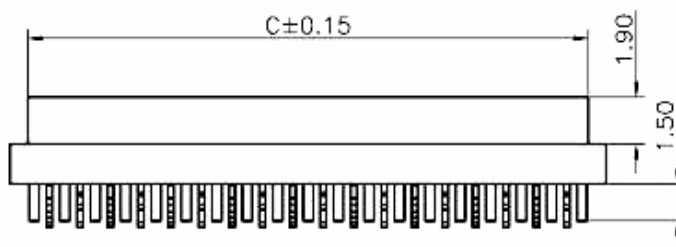
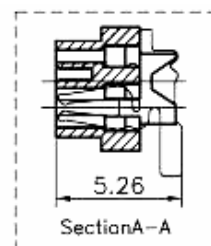
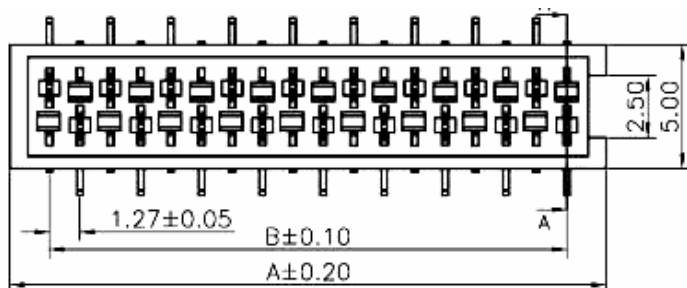

PCB Layout

Pos	A	B	C	Pos	A	B	C
4	7.00	3.81	5.60	16	22.24	19.05	20.84
6	9.54	6.35	8.14	18	24.78	21.59	23.38
8	12.08	8.89	10.68	20	27.32	24.13	25.92
10	14.62	11.43	13.22	22	29.86	26.67	28.46
12	17.16	13.97	15.76	24	32.40	29.21	31.00
14	19.70	16.51	18.30	26	34.94	31.75	33.54

**General Specification**

<p><b>Materials and Finish :</b></p> <p><b>Insulator:</b> Glass-reinforce thermo plastic, UL 94V-0, Nylon, Color in Red</p> <p><b>Contact :</b> Phosphor Bronze, Tin plated.</p>	<p><b>Electrical :</b></p> <p><b>Contact Resistance:</b> 20 mΩ max. at 1A DC</p> <p><b>Insulation Resistance:</b> 1000 MΩ min, at 500 V/DC.</p> <p><b>Dielectric Withstanding Voltage :</b> 500 V AC/RMS 60Hz for one minute.</p> <p><b>Current Rating :</b> 1.5 A max</p> <p><b>Voltage Rating :</b> 230V AC/RMS 60Hz, DC</p>	<p><b>Environment :</b></p> <p><b>Operating Temperature:</b> -40 degree C to +105 degree C</p>
--	--	--

TMM

TMM Series  
1.27mm pitch

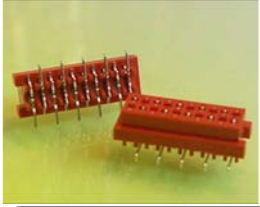

X	-X	-XX	-X
---	----	-----	----

Type	Locking	No. of Positions	Packaging
1=IDC Male	L= with Lock	04= 04 Positions	1= Tape&Reel+cap
2=IDC Transition Plug	0= w/o Lock	:	2= Tube
3=DIP Male Straight		:	3= Bag
4=DIP Female Straight		26= 26 Positions	4= Tape&Reel w/o cap
5=DIP Female R/A			
6=SMT Female Straight			

TMM-6-L  
(SMT Female ST w/lock)

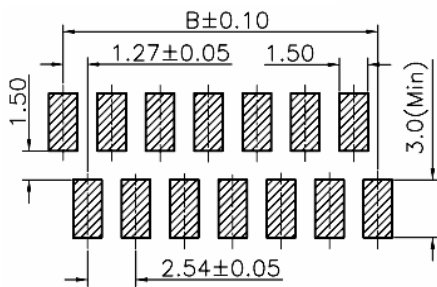
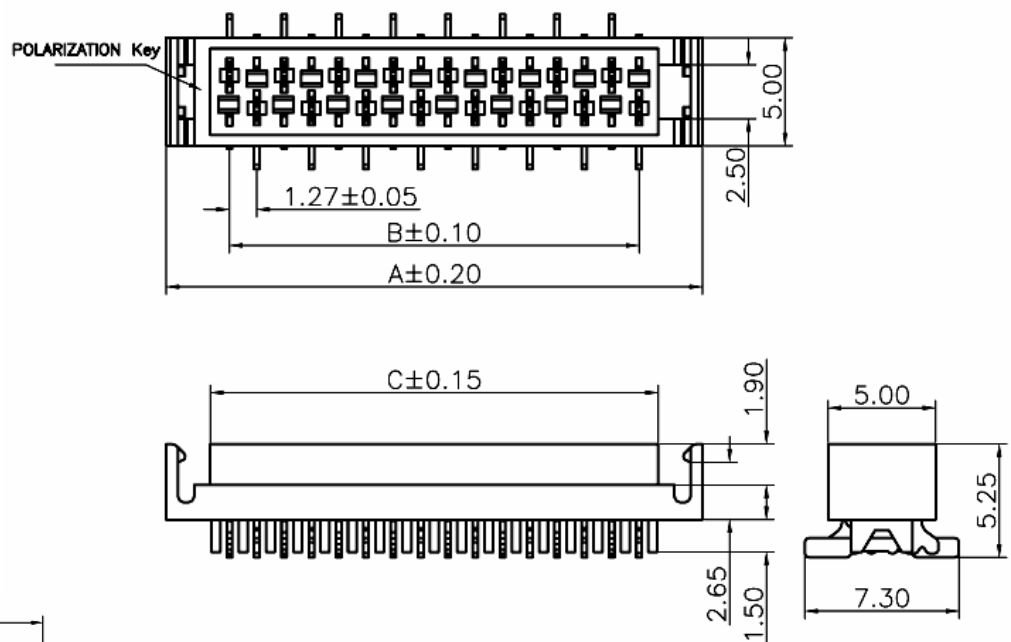

PCB Layout

Pos	A	B	C	Pos	A	B	C
4	9.70	3.81	5.60	16	24.94	19.05	20.84
6	12.24	6.35	8.14	18	27.48	21.59	23.38
8	14.78	8.89	10.68	20	30.02	24.13	25.92
10	17.32	11.43	13.22	22	32.56	26.67	28.46
12	19.86	13.97	15.76	24	35.10	29.21	31.00
14	22.40	16.51	18.30	26	37.64	31.75	33.54

General Specification

Materials and Finish :	Electrical :	Environment :
<p><b>Insulator:</b> Glass-reinforce thermo plastic, UL 94V-0, Nylon, Color in Red.</p> <p><b>Contact :</b> Phosphor Bronze, Tin plated.</p>	<p><b>Contact Resistance:</b> 20 mΩ max. at 1A DC</p> <p><b>Insulation Resistance:</b> 1000 MΩ min, at 500 V/DC.</p> <p><b>Dielectric Withstanding Voltage :</b> 500 V AC/RMS 60Hz for one minute.</p> <p><b>Current Rating :</b> 1.5A max,</p> <p><b>Voltage Rating :</b> 230V AC/RMS 60Hz, DC</p>	<p><b>Operating Temperature:</b> -40 degree C to +105 degree C</p>



## X-ON Electronics

Largest Supplier of Electrical and Electronic Components

*Click to view similar products for [Headers & Wire Housings](#) category:*

*Click to view products by [Amphenol](#) manufacturer:*

Other Similar products are found below :

[95000-104TRLF](#) [10135584-644402LF](#) [DF62W-EP2022PCA](#) [95000-106TRLF](#) [DF62W-2022SCA](#) [DF62W-EP2022PC](#) [2203348](#) [DF62W-2022SC](#) [1084018](#) [1029039](#) [1084017](#) [802-10-012-10-002000](#) [1112640](#) [1112639](#) [000-34000](#) [0009482033](#) [0009507031](#) [57102-S06-03LF](#) [57202-S52-04LF](#) [PCN6-15S-2.5E](#) [0039019024](#) [58102-G61-06LF](#) [582553-1](#) [0009485154](#) [0009508121](#) [0022285053](#) [0050291907](#) [018731A](#) [LY20-4P-DT1-P1E-BR](#) [02.125.8002.8](#) [60101931](#) [60598-1 \(Cut Strip\)](#) [M1625-3R/100](#) [61062-3](#) [61082-181009](#) [636-1427](#) [638009-1](#) [641938-9](#) [641991-4](#) [644168-1](#) [647662-1](#) [65039-019ELF](#) [65781-047](#) [65817-002LF](#) [65817-015LF](#) [65863-015LF](#) [66207-023LF](#) [67016-026LF](#) [67046-001LF](#) [67095-007LF](#)