

MATRIX 38999 CONNECTORS

PDS - 320



Amphenol's Matrix 38999 series combines the best of the both 5015 and D38999 Military connectors. This new series uses Mil-Qualified inserts from Amphenol's Matrix 5015 series and combines them with the mechanical interface of D38999. Upgrade your EMI performance to D38999 levels without changing your 5015 pin-outs or cable assemblies.

New technologies are available including Amphenol high current contacts, AP-93 1000 hour salt spray plating, and the new SWAMP seal to prevent ingress of corrosive fluids into the mating thread area. Countless contact termination methods are available, and new pin outs and custom design are available via Amphenol's Tracer rapid prototyping service. Modern connectors for a more civilized age at Amphenol Aerospace.

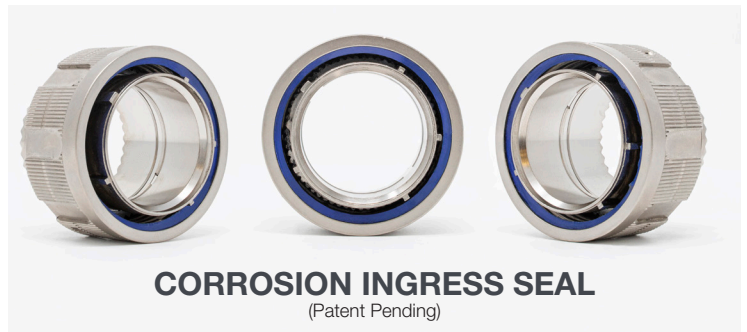

FEATURES:

- High Power Contact Technology – (RADSOK, TEMPERGRIP)
- Based off D38999 Series III connectors
- Improved durability of receptacle threads, fewer turns for full-mate
- 1000 HR Reach & RoHS plating available intermatable to Cadmium
- Rapid prototypes available through Amphenol Tracer Service

CURRENT CARRYING COMPARISON SIZES

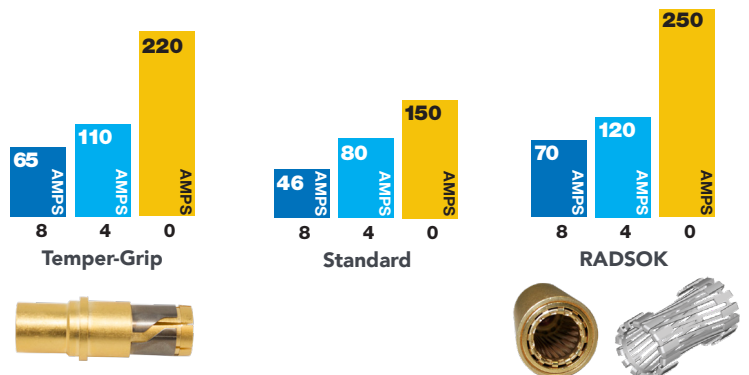

CONTACT FOR PART NUMBER & AVAILABILITY

Matt Kistner • Office: +1 (607) 563-5110 • Email: mkistner@amphenol-ao.com
amphenol-aerospace.com • amphenolmao.com

1. Connector Type	2. Shell Style	3. Service Class	4. Shell Size-Insert Arrangement	5. Contact Type	6. Alternate Positions
TVM	00	DZ-	25L-20	P	B

1. CONNECTOR TYPE	
TVM	Matrix 38999, Tri-Start Series III with 5015 Inserts

2. SHELL STYLE	
00	Wall Mount Receptacle
07	Jam Nut Receptacle
06	Straight Plug
36	Straight Plug w/SWAMP Seal
96	Plug with Integral Banding Platform
80	Wall Mount with Integral Banding Platform
87	Jam Nut with Integral Banding Platform

3. SERVICE CLASS	
DR-	Electroless Nickel, Aluminum 48 hr. 200°C EMI shielding -65dB@10GHz RoHS®
DW-	Olive Drab Cadmium-500 hrs. salt spray, -65dB@10GHz
DT-	Durmalon: Gray non-reflective finish, RoHS® compliant cad & Hexavalent Chromium free. 500 hours extended salt spray, EMI -50db @ 10 GHz specification min.
DZ-	Black Zinc-Nickel alternative to cadmium. Corrosion resistant, 500 hour salt spray, conductive, EMI shielding -65db @ 10 GHz specification min*
DB-	Black Electroless Nickel, Aluminum, 48 Hr, 200°C, -65dB@10GHz, RoHS®
DS-	AP-93 Tri-Nickel Alloy, Aluminum, 1000 Hr., 200°C, -65dB@10GHz, RoHS®
RL-	Nickel Plated (Non-Firewall): 500 hrs. salt, -50dB@10GHz, RoHS®
RKN-	Passivated (Non-Firewall): 500 hrs. salt, -65dB@10GHz, RoHS®

4. SHELL SIZE & INSERT ARRANGEMENT	
PG 3-5	Insert Arrangements

Contact factory about High Voltage 5015 Inserts!



5. SOCKET TYPE / PIN	
SOCKET	
S	Standard Socket
R	RADSOK: Recommended up to 150°C*
T	Temper-Grip: Recommended for 200°C +*
PIN	
P	Pin
U	High Current Pin (TeCu)

*Size 12 & 16 are standard sockets

6. ALTERNATE POSITIONS					
Shell Size	Key & keyway arrangement identification letter	AR° or AP° BSC	BR° or BP° BSC	CR° or CP° BSC	DR° or DP° BSC
23L, 25L, 33 and 37	N*	80	142	188	293
	A	135	170	188	310
	B	49	169	188	244
	C	66	140	188	257
	D	62	145	188	280
	E	79	153	188	272

A plug with a given rotation letter will mate with a receptacle with the same rotation letter. The angles for a given connector are the same whether it contains pins or sockets. Inserts are not rotated in conjunction with the master key/keyway.

RECEPTACLE front face shown

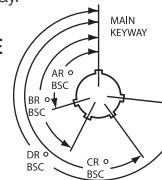

PLUG front face shown

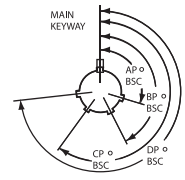

CONTACT FOR PART NUMBER & AVAILABILITY

Matt Kistner • Office: +1 (607) 563-5110 • Email: mkistner@amphenol-ao.com
amphenol-aerospace.com • amphenolmao.com

INSERT ARRANGEMENTS

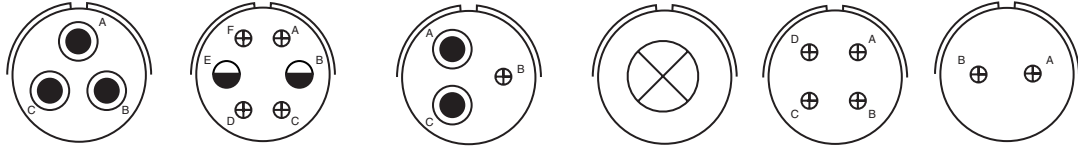

Insert Arrangement	23L-2	23L-5		23L-6		23L-7	23L-10		23L-11
Service Rating	D	D		D		E	E		B
Number of Contacts	3	2	4	2	1	1	4		2
Contact Size	8	12	16	8	16	0	16		16

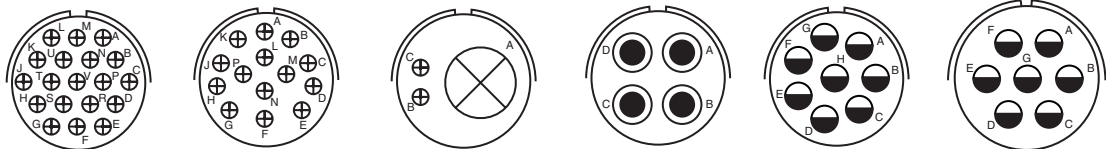

Insert Arrangement	23L-14	23L-19		23L-21		23L-22†	23L-23		25L-2
Service Rating	A	A		A		A	H=D, Bal.=A		D
Number of Contacts	19	14		1	2	4	8		7
Contact Size	16	16		0	16	8	123		12

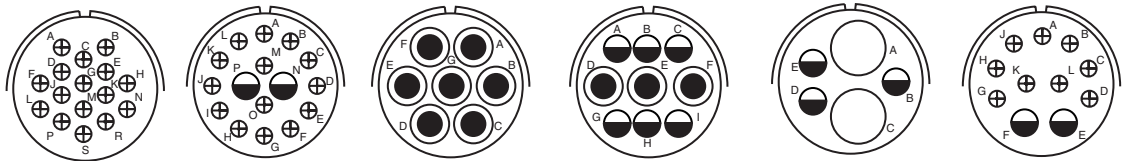

Insert Arrangement	25L-5	25L-7		25L-10		25L-11		25L-12		25L-20
Service Rating	A	A		A		A		A		D
Number of Contacts	19	2	14	7	3	6	2	3	9	
Contact Size	16	12	16	8	8	12	4	12	16	

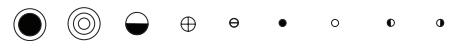

CONTACT LEGEND 8 10 12 16 20 22 22M 22D 23

CONTACT FOR PART NUMBER & AVAILABILITY

Matt Kistner • Office: +1 (607) 563-5110 • Email: mkistner@amphenol-ao.com
amphenol-aerospace.com • amphenolmao.com

INSERT ATTANGEMENTS



Insert Arrangement	25L-22	25L-28	33-1		33-2	
Service Rating	D	Inst.	A, J, E = D; Bal. = A		D	
Number of Contacts	4	24	3	6	2	12
Contact Size	8	18	8	12	12	16

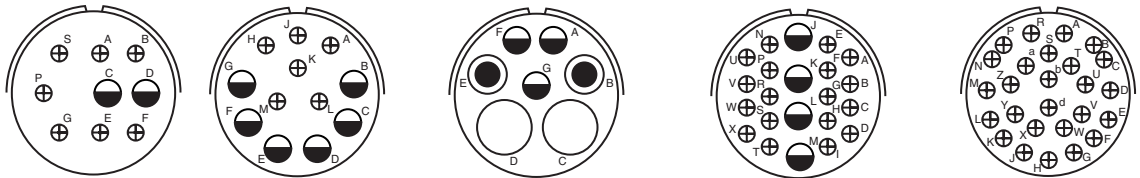

Insert Arrangement	33-4	33-9	33-10			33-11		33-12
Service Rating	D	Inst.	G = D, Bal. = A			A		A
Number of Contacts	4	24	2	2	3	4	18	26
Contact Size	8	18	4	8	12	12	16	16

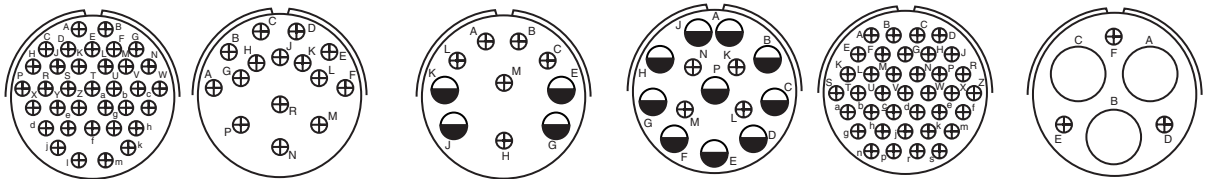

Insert Arrangement	33-15	33-17	33-19		33-20		33-21		33-22	
Service Rating	A	R=B; M, N, P=D; Bal.=A	H, M=B; A, B=D; Bal.=A		A		A		D	
Number of Contacts	35	15	4	6	10	4	37	3	3	
Contact Size	16	16	12	16	12	16	16	4	16	

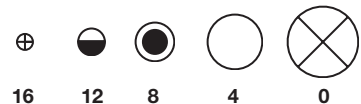

CONTACT LEGEND

CONTACT FOR PART NUMBER & AVAILABILITY

Matt Kistner • Office: +1 (607) 563-5110 • Email: mkistner@amphenol-ao.com
amphenol-aerospace.com • amphenolmao.com

INSERT ARRANGEMENTS

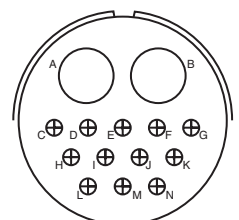
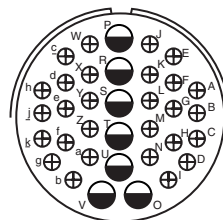
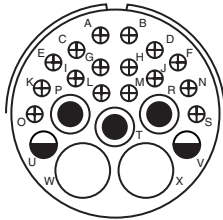
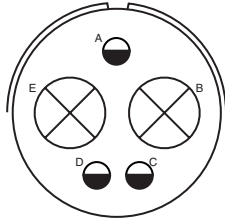

Insert Arrangement	37-1†		37-6				37-7		37-9	
Service Rating	A = E; B, C, D, E = D		A				A, B, H, J=Inst.; Bal.=A		D	
Number of Contacts	2	3	2	3	2	16	7	28	2	12
Contact Size	0	12	4	8	12	16	12	16	4	16

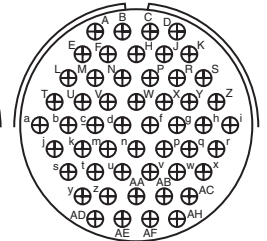
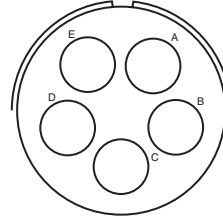
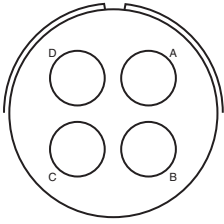
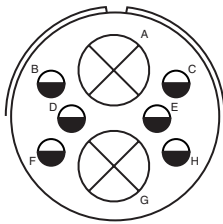
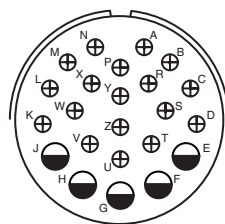

Insert Arrangement	37-13		37-15†		37-17†	37-63		37-73	
Service Rating	D		D		D	D		A	
Number of Contacts	5	18	2	6	4	5	46		
Contact Size	12	16	0	12	4	4	16		

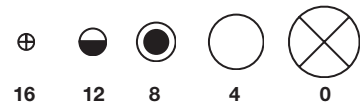

CONTACT LEGEND

CONTACT FOR PART NUMBER & AVAILABILITY

Matt Kistner • Office: +1 (607) 563-5110 • Email: mkistner@amphenol-ao.com
amphenol-aerospace.com • amphenolmao.com

TVM00 Wall Mount Receptacle

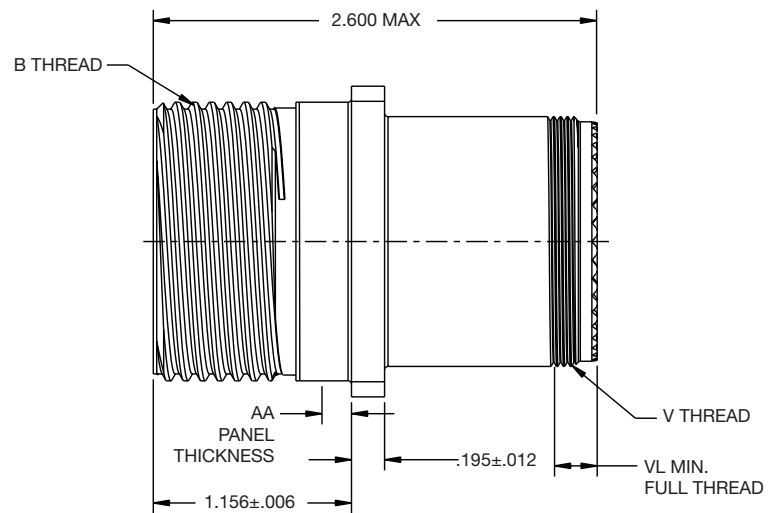
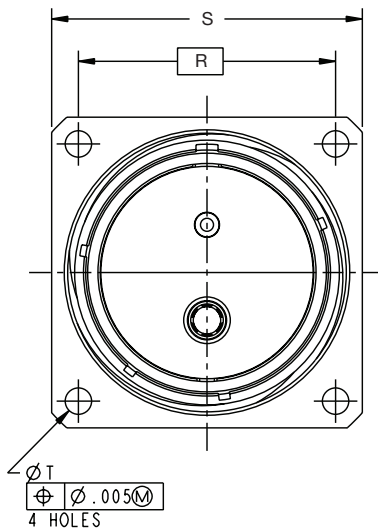

TVM00								
TVM06 Part Number	Shell Size	B Thread Class 2A	R	S	Ø T	V Thread	AA Panel Thickness	L Min Full Threaded
TVM00RW-23L-()	23L	1.5000-0.1P-036-TS	1.375	1.688	.154	M34x1-6g0.100R	.062-.125	.280
TVM00RW-25L-()	25L	1.6250-0.1P-0.3L-TS	1.500	1.812	.154	M37X1-6g0.100R	.062-.125	.280
TVM00RW-33-()	33	1.8750-0.1P-0.3L-TS	1.750	2.312	.209	M45X1-5-6g0.188R	.062-.125	.594
TVM00RW-37-()	37	2.1250-0.1P-0.3L-TS	1.922	2.484	.209	M50X1-5-6g0.188R	.062-.125	.594

CONTACT FOR PART NUMBER & AVAILABILITY

Matt Kistner • Office: +1 (607) 563-5110 • Email: mkistner@amphenol-ao.com
amphenol-aerospace.com • amphenolmao.com

TVM07 Jam Nut Receptacle

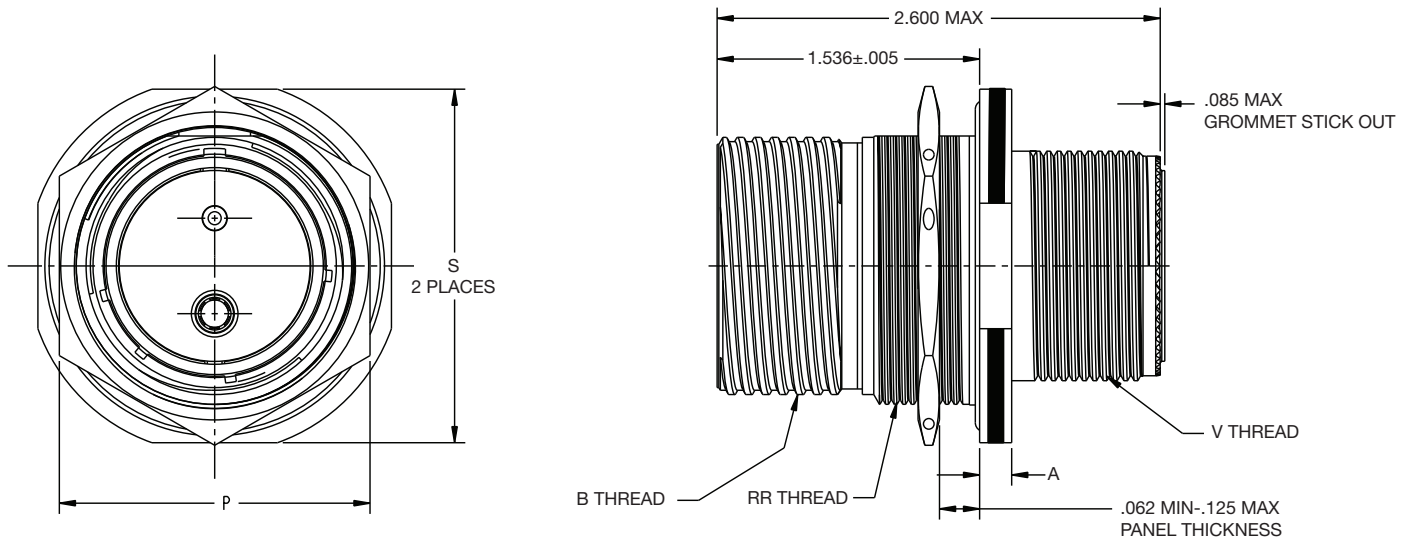

TVM07							
TVM07 Part Number	Shell Size	A +.010 -.005	B Thread Class 2A	P Hex +.017 -.016	RR Thread	S +.011 -.010	V Thread
TVM07RF-23L-() ()	23L	.188	1.5000.0.1P-0.3L-TS	1.812	M41XI-6g0.100R	2.062	M34XI-6g0.100R
TVM07RF-25L-() ()	25L	.188	1.6250.0.1P-0.3L-TS	2.000	M44x1-6g0.100R	2.188	M37x1-6g0.100R
TVM07RF-33-() ()	33	.188	1.8750.0.1P-0.3L-TS	2.250	M50XI-6g0.188R	2.469	M45XI-.5-6g0.188R
TVM07RF-37-() ()	37	.188	2.1250.0.1P-0.3L-TS	2.625	M60XI-6g0.188R	2.828	M50XI-.5-6g0.188R

CONTACT FOR PART NUMBER & AVAILABILITY

Matt Kistner • Office: +1 (607) 563-5110 • Email: mkistner@amphenol-ao.com
amphenol-aerospace.com • amphenolmao.com

TVM06 Plug

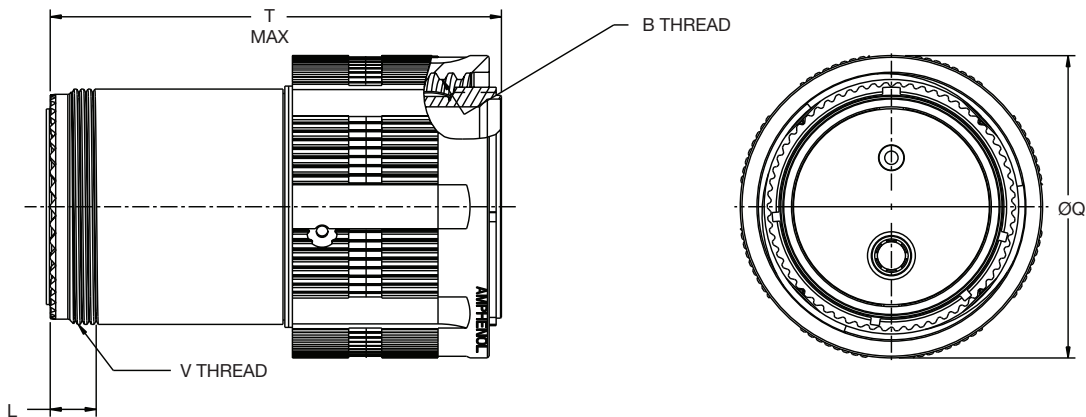

TVM06						
TVM06 Part Number	Shell Size	B Thread Class 2A	Ø Q Max	V Thread 9	L Min Full Threaded	T Max
TVM06RW-23L-()	23L	1.5000-0.1P-0.3L-TS	1.750	M34X 1-6g0.100R	.280	2.579
TVM06RW-25L-()	25L	1.6250-0.1P-0.3L-TS	1.875	M37X 1-6g0.100R	.280	2.579
TVM06RW-33-()	33	1.8750-0.1P-0.3L-TS	2.203	M45X 1-5-6g0.188R	.594	2.579
TVM06RW-37-()	37	2.1250-0.1P-0.3L-TS	2.391	M50X 1-5-6g0.188R	.594	2.579

CONTACT FOR PART NUMBER & AVAILABILITY

Matt Kistner • Office: +1 (607) 563-5110 • Email: mkistner@amphenol-ao.com
amphenol-aerospace.com • amphenolmao.com

X-ON Electronics

Largest Supplier of Electrical and Electronic Components

Click to view similar products for [Circular MIL Spec Connector](#) category:

Click to view products by [Amphenol](#) manufacturer:

Other Similar products are found below :

[0025-262-542](#) [0025-264-3014](#) [58-570121-04S](#) [0134-202-1200](#) [0134-207-1206](#) [0134-207-1800](#) [0134-207-2207](#) [0134-213-0806](#) [0134-213-1007](#) [0134-213-1009](#) [0134-213-1208](#) [0134-213-1800](#) [0134-213-2209](#) [0025-258-000](#) [015-9516-002](#) [60-042217-10P](#) [60-042722-19P](#) [0114-201-1278](#) [602GB06EG24-61SN](#) [0134-201-1207](#) [0134-201-1806](#) [0134-201-2006](#) [0134-201-2007](#) [0134-201-2010](#) [0134-202-1400](#) [0134-207-0809](#) [0134-207-1208](#) [0134-207-2009](#) [0134-213-1006](#) [6104-207-2302](#) [6104-208-1902](#) [6131-202-19149P](#) [6131-204-21149P](#) [6131-207-13149P](#) [6131-208-13149P](#) [6131-209-17149P](#) [6131-210-11149P](#) [6131-211-19149P](#) [6131-216-19149P](#) [6131-220-25149P](#) [6131-259-11149P](#) [6131-259-21149P](#) [6131-259-23149P](#) [6131-263-19149P](#) [6131-265-17149P](#) [6131-265-19149P](#) [6134-203-21149](#) [CS3102A-20-15P](#) [CS3102A-20-15S](#) [CS3102A-28-15S](#)