

Amphenol



UPC Series

www.amphenol-industrial.com



ABOUT US

Amphenol Industrial Operations

Amphenol Industrial Operations (AIO), headquartered in a 20,000 square foot facility in Endicott, N.Y., provides a full range of high reliability power/signal connectors and interconnection systems specifically for the industrial markets including rail/mass transit, process control, automotive manufacturing, heavy equipment, wireless base stations and power generation. Products include ruggedized-for-industry cylindrical, fiber optic, rectangular, and industrialized versions of Amphenol's MIL-DTL-5015 cylindrical, MIL-DTL-26482 miniature cylindrical and GT reverse bayonet cylindrical connectors. The facility is both ISO9001 certified and qualified to MIL-STD-790 requirements.



Endicott Factory

Amphenol is one of the largest manufacturers of interconnect products in the world

The company designs, manufactures and markets electrical, electronic and fiber optic connectors, coaxial and flat-ribbon cable, and interconnect systems. Amphenol has long been the accepted leader in providing quality connectors and interconnect systems to the Industrial, Military and Telecommunication markets.



Zhuhai Factory 1

Amphenol Technology (Zhuhai) Co., Ltd.

Established in 2007, Amphenol Technology (Zhuhai) Co., Ltd. is a manufacturing facility for Amphenol Industrial Operations, which serves a number of industrial markets, included but not limited to Factory Automation, Transportation, Heavy Equipment, Alternative Energy, Energy Storage, Server/Data Comm and Power Distribution.

Amphenol Technology (Zhuhai) Co., Ltd. covers an area of 28,470m² and is equipped with CNC, plating, injection molding and assembly workshops. This plant specializes in the design and manufacturing of industrial connectors featuring high power, high density, medium to high voltage electrical properties, and harsh environment applications.

With industry leading engineering, design, and manufacturing expertise, Amphenol Technology (Zhuhai) Co., Ltd. has earned more than 60 utility patents on its innovative interconnects. Many of the products produced have been certified by independent standards including UL, IEC/TUV, ATEX, IECEx and MA. The facility is also certified to ISO 9001, ISO 14001 and IATF 16949.



Zhuhai Factory 2

UPC Connector

UPC (Ultimate Power Connector) is a plastic power connector series designed to be used in the hybrid electric vehicle and heavy equipment markets. The 2-pole and 3-pole connectors incorporate patented RADSOK® technology which provides higher amperage, lower T-rise and voltage drop, and less resistance. RADSOK's twisted grid configuration allows for up to 50% more current to pass through the same size pin, while providing increased reliability and cycle durability, as well as lower mating forces.

The compact plastic shell structure is light weight with a small footprint. There is a 9.1mm and 14.0mm version which can carry currents up to 200A to 450A, field installable and repairable. These attributes make the UPC robust and the interconnect of choice for the EV and Hybrid markets.



Markets and Applications

- Hybrid/ Electric Vehicle
- Heavy Equipment
- Battery Pack
- PDU
- MCU



UPC 9.1mm

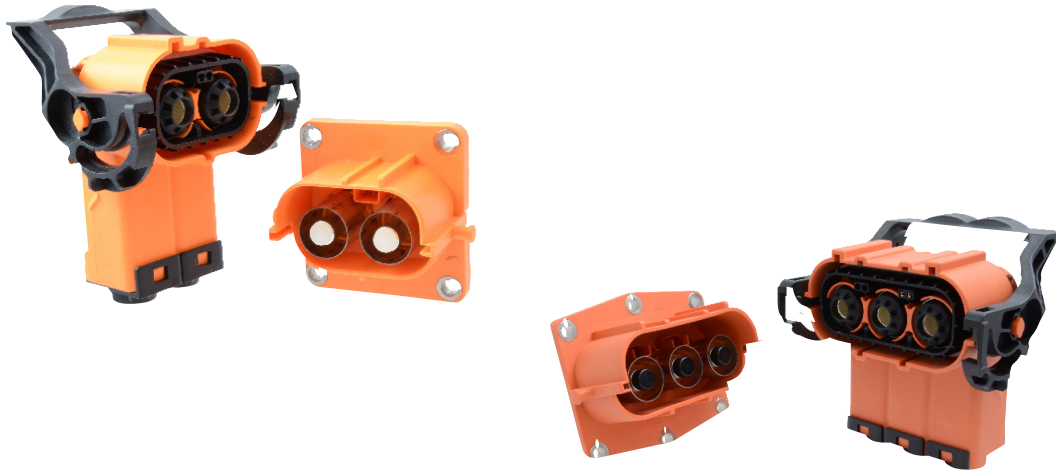

- Plastic shell, light weight
- Compact design for space considerations with EVs
- Wide amperage range up to 200A
- Low mating/un-mating force
- Durability: 100min. cycles
- Touch-proof: IP 2XB (IEC 60529)
- Flammability: UL 94V-0
- HVIL (High Voltage Interlock Loop)
- EMI Shielding
- IP67 & IP69k when mated
- RoHS Compliant
- With CPA function (Only for 2 way & 3 way straight version)

Technical Data							
Current Rating	200A (50mm ²) 150A (35mm ²) 120A (25mm ²) (Room Temperature: 25°C)	Test Voltage (sea level)	3000 VAC RMS	Ingress Protection	IP67 & IP69k (Mated)	Touch-Proof	YES
Contact Size	9.1mm	Operating Temperature	-40 °C to 125 °C	EMI	360°	HVIL	Integrated
Operating Voltage	1000V DC(Max.) /750V AC(Max.)	Durability	100 (Min) Mating Cycles	Flammability	UL94 V-0	Recommended Torque	1. Receptacle assembly to panel M5:6±10% 2. Busbar M5:6±10% M6:8±10%

2-Pole Receptacle

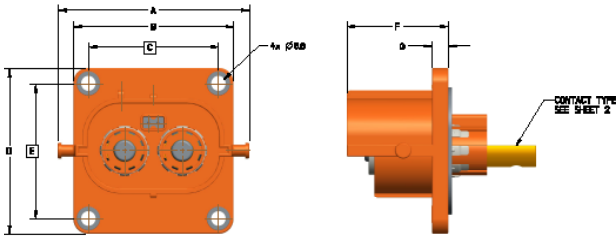

Size	2-Pole Receptacle Dimensions						
	A	B	C	D	E	F	G
9.1mm	76.6	64	52	66	54	40.5	6.5

2-Pole Plug

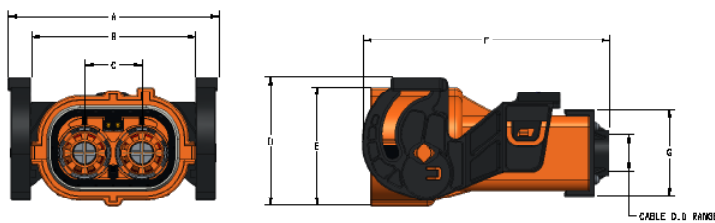

Size	2-Pole Plug Dimensions							Cable O.D. Range
	A	B	C	D	E	F	G	
9.1mm	85.1	66	23	51.9	47.8	99.4	34.5	50mm ² : Ø15~17.5 35mm ² : Ø14~15 25mm ² : Ø13.2~13.8

90° Angular 2-Pole Plug

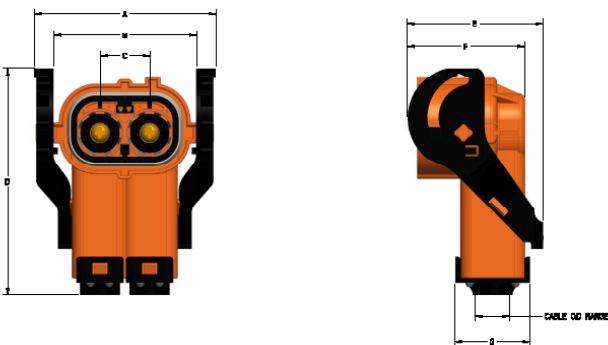

Size	90° Angular 2-Pole Plug Dimensions							Cable O.D. Range
	A	B	C	D	E	F	G	
9.1mm	84	66	23	106	63	54	34.5	50mm ² : Ø15~17.5 35mm ² : Ø14~15 25mm ² : Ø13.2~13.8

2-Pole Receptacle Termination

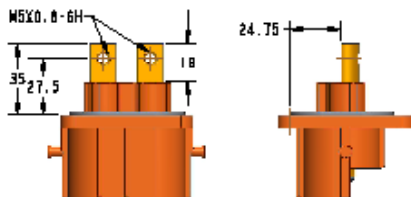

Busbar Type

Size	9.1mm
PA	52
PB	23
PC	9.5
PD	54
PE	27
PF	14.7
PG	4.5
PH	23

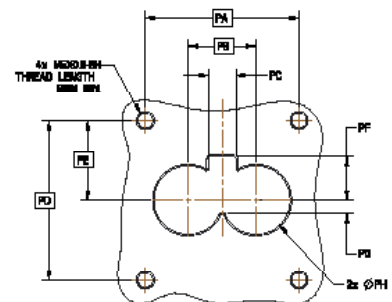

Notice: Specifications are subject to change without notice. Contact your nearest Amphenol Corporation Sales Office for the latest specifications. All statements, information and data given herein are believed to be accurate and reliable but are presented without guarantee, warranty, or responsibility of any kind, expressed or implied. Statements of suggestions concerning possible use of our products are made without representation or warranty that any such use is free of patent infringement and are not recommendations to infringe any patent. The user should assume that all safety measures are indicated or that other measures may not be required. Specifications are typical and may not apply to all connectors.

3-Pole Receptacle

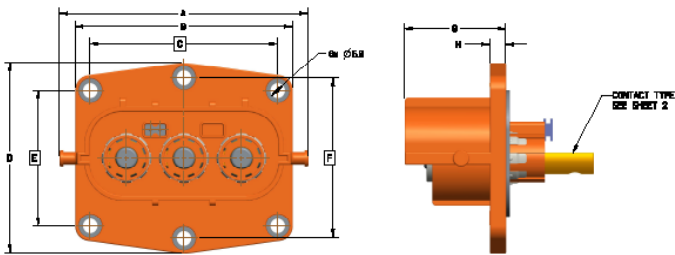

Size	3-Pole Receptacle Dimensions							
	A	B	C	D	E	F	G	H
9.1mm	99.6	87	75	76	54	64	40.5	6.5

3-Pole Plug

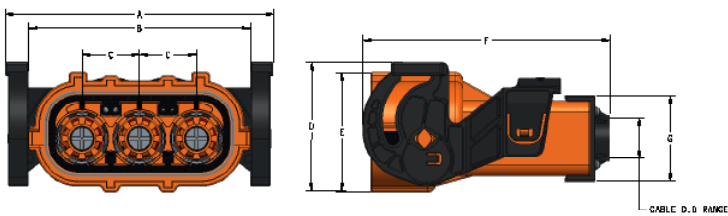

Size	3-Pole Plug Dimensions							
	A	B	C	D	E	F	G	Cable O.D. Range
9.1mm	108.1	89	23	51.9	47.8	99.4	34.5	50mm ² : Ø15~17.5 35mm ² : Ø14~15 25mm ² : Ø13.2~13.8

90° Angular 3-Pole Plug

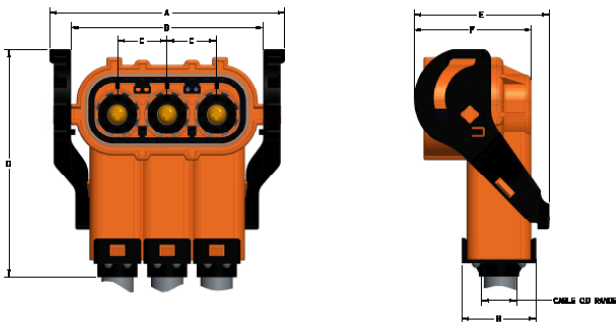

Size	90° Angular 3-Pole Plug Dimensions							
	A	B	C	D	E	F	G	Cable O.D. Range
9.1mm	107	89	23	106	63	54	34.5	50mm ² : Ø15~17.5 35mm ² : Ø14~15 25mm ² : Ø13.2~13.8

3-Pole Receptacle Termination

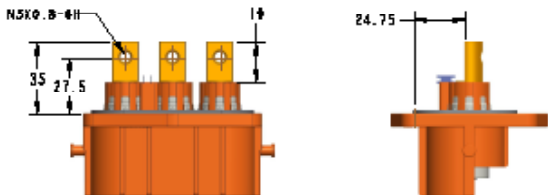

Busbar Type

Size	9.1mm
PA	75
PB	23
PC	9.5
PD	11.5
PE	64
PF	54
PG	27
PH	14.7
PJ	4.5
PL	37.5
PK	23

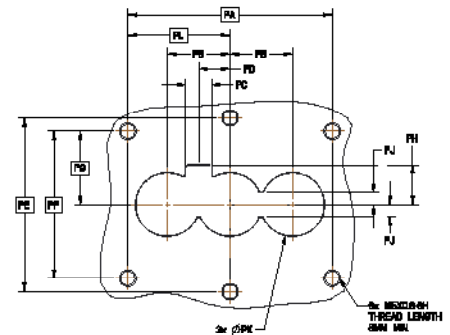

Notice: Specifications are subject to change without notice. Contact your nearest Amphenol Corporation Sales Office for the latest specifications. All statements, information and data given herein are believed to be accurate and reliable but are presented without guarantee, warranty, or responsibility of any kind, expressed or implied. Statements of suggestions concerning possible use of our products are made without representation or warranty that any such use is free of patent infringement and are not recommendations to infringe any patent. The user should assume that all safety measures are indicated or that other measures may not be required. Specifications are typical and may not apply to all connectors.

UPC 14.0mm



- High current, 450A Max rated current
- EMI Shielding
- HVIL (High Voltage Interlock Loop)
- Secondary Lock design
- R4 RADSOK® Technology
- IP67 (when mated)
- Quick lock and push to release design
- Keyway design to prevent incorrect mating
- Compact Robust Design
- UL94 V-0 (self extinguishing)
- Wide operating temperature range (-40°C to 125°C)

Technical Data

Current Rating	450A (150 mm ²) 400A (120 mm ²) 350A (95mm ²) (Room Temperature: 25°C)	Test Voltage (sea level)	3000 VAC RMS	Ingress Protection	IP67 (Mated)	Touch-Proof	YES
Contact Size	14.0mm RADSOK®	Operating Temperature	-40°C to 125°C	EMI	360°	HVIL	Integrated
Operating Voltage	1000V DC	Durability	100 (Min) Mating Cycles	Flammability	UL 94 V-0	Recommended Torque	1. Receptacle assembly to panel M5: 6±10% 2. Busbar M5: 6±10% M6: 8±10% M8: 15±10%

2-Pole Receptacle

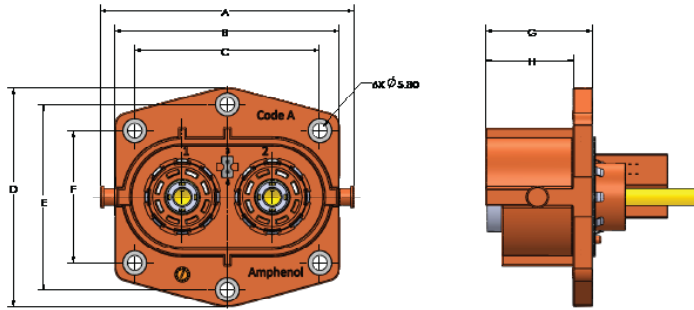

Size	2-Pole Receptacle Dimensions							
	A	B	C	D	E	F	G	H
14.0mm	101.6	90	74	87.9	74	53	42.7	35

90° Angular 2-Pole Plug

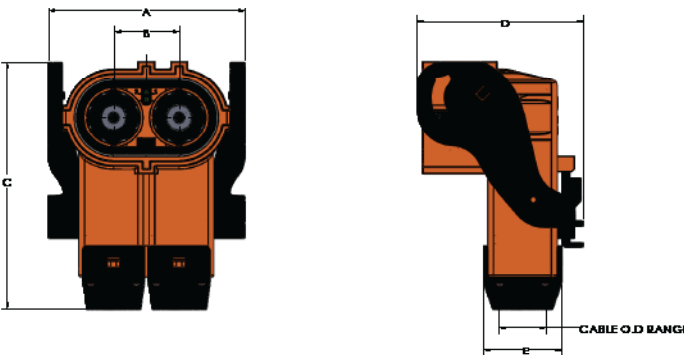

Size	90° Angular 2-Pole Plug Dimensions							
	A	B	C	D	E	F	G	Cable O.D. Range
14.0mm	85.1	66	23	51.9	47.8	99.4	34.5	95mm ² : Ø22.0~23.2 12.0mm ² : Ø23.9~25.3 15mm ² : Ø26.3~27.9

2-Pole Receptacle Termination

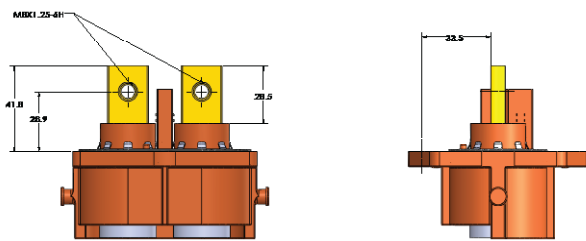

Busbar Type

Cut-Out Panel Dimensions

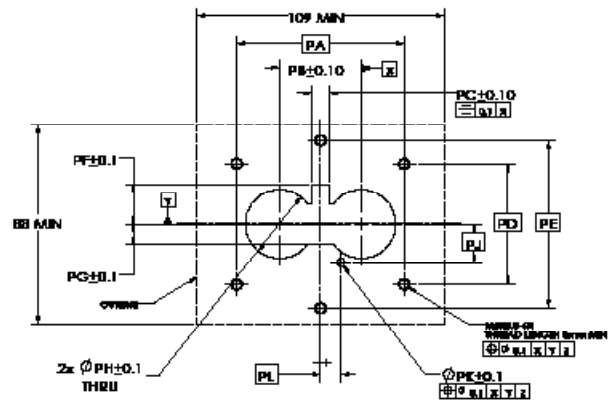

Size	Cut out Panel Dimensions										
	PL	PB	PC	PD	PE	PF	PG	PH	PJ	PK	PL
14.0mm	74	36	8	53	74	17.5	9	30.2	17	3.5	Code A: 9
											Code B: 3
											Code C: -3
											Code D: -9

Notice: Specifications are subject to change without notice. Contact your nearest Amphenol Corporation Sales Office for the latest specifications. All statements, information and data given herein are believed to be accurate and reliable but are presented without guarantee, warranty, or responsibility of any kind, expressed or implied. Statements of suggestions concerning possible use of our products are made without representation or warranty that any such use is free of patent infringement and are not recommendations to infringe any patent. The user should assume that all safety measures are indicated or that other measures may not be required. Specifications are typical and may not apply to all connectors.

• **What is a CPA mechanism?**

CPA (Connector Position Assurance): A locking apparatus that holds the coupling mechanism of a connector together. The CPA is usually an optional device. It prevents accidental release of the connector lock and serves as an indicator of full connector mating.

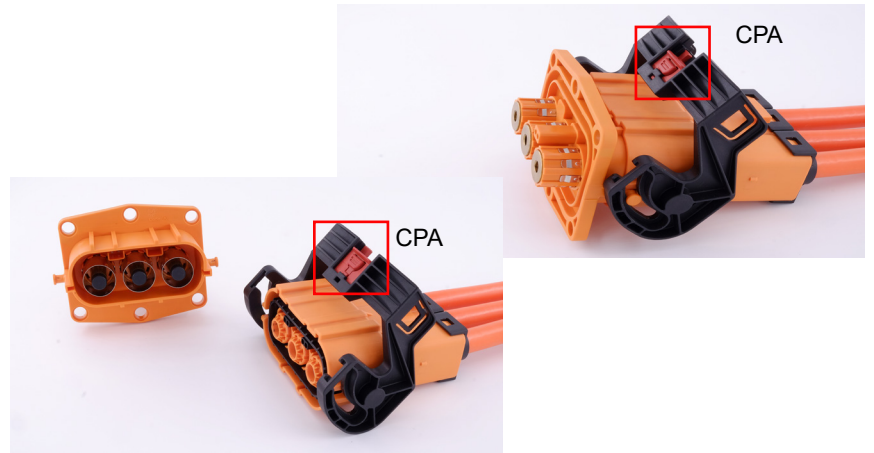

How to Order

9.1mm Plug

1.	2.	3.		4.		5.		6.		7.	8.		9.			
UPC	P	01		2		A		L		S	1		C			
Product Series	Connector Type	RADSOK® Contact Size		Number of Poles		Coding Selection		HVIL Selection		EMI Selection	Contact Type		CPA Selection <small>(Only available for 9.1mm 2way & 3way straight version.)</small>			
UPC	P	90° Plug	01	9.1mm	2	2-Pole	A	Code A	L	HVIL	S	With Shielding Shell	1	35mm² (9.1mm Only)	C	With CPA
	IP	Straight Plug			3	3-Pole	B	Code B	N	No HVIL			2	50mm² (9.1mm Only)		
							C	Code C					5	25mm² (9.1mm Only)		
							D	Code D								

9.1mm Receptacle

1.	2.		3.		4.		5.		6.		7.	8.		
UPC	R		01		3		B		N		S	1		
Product Series	Connector Type		RADSOK® Contact Size		Number of Poles		Coding Selection		HVIL Selection		EMI Selection	Contact Type		
UPC	R	Receptacle	01	9.1mm	2	2-Pole	A	Code A	L	HVIL	S	With Shielding Shell	1	Busbar Type
					3	3-Pole	B	Code B	N	No HVIL				
							C	Code C						
							D	Code D						

14mm Plug

1.	2.		3.		4.		5.		6.		7.		8.	
UPC	P		02		2		A		L		S		1	
Product Series	Connector Type		RADSOK® Contact Size		Number of Poles		Coding Selection		HVIL Selection		EMI Selection		Contact Type	
UPC	P	90° Plug	02	14mm	2	2-Pole	A	Code A	L	HVIL	S	With Shielding Shell	3	95mm ² (14mm Only)
							B	Code B	N	No HVIL			4	120mm ² (14mm Only)
							C	Code C					6	150mm ² (14mm Only)
							D	Code D						

14mm Receptacle

1.	2.		3.		4.		5.		6.		7.		8.	
UPC	R		02		3		B		N		S		1	
Product Series	Connector Type		RADSOK® Contact Size		Number of Poles		Coding Selection		HVIL Selection		EMI Selection		Contact Type	
UPC	R	Receptacle	02	14mm	2	2-Pole	A	Code A	L	HVIL	S	With Shielding Shell	1	Busbar Type
							B	Code B	N	No HVIL				
							C	Code C						
							D	Code D						

North America

Amphenol Industrial Operations
20 Valley Street
Endwell, NY13760-3600
USA
Tel: +1-888-364-9011
Fax: +1-520-397-7169
www.amphenol-industrial.com
Email: tech@amphenol-aio.com

Asia

Amphenol Technology(Zhuhai) Co., Ltd.
No.63, Xinghan Road, Sanzao Town,
Jinwan, Zhuhai, 519040
China
Tel: +86-756-398 9725
Fax: +86-756-398 9768
www.amphenol-industrial.com
Email: tech@amphenol-aio.com

IB-8-4

Notice: Specifications are subject to change without notice. Contact your nearest Amphenol Corporation Sales Office for the latest specifications. All statements, information and data given herein are believed to be accurate and reliable but are presented without guarantee, warranty, or responsibility of any kind expressed or implied. Statements or suggestions concerning possible use of our products are made without representation or warranty that any such use is free of patent infringement and are not recommendations to infringe any patent. The user should not assume that all safety measures are indicated or that other measures may not be required. Specifications are typical and may not apply to all connectors.

X-ON Electronics

Largest Supplier of Electrical and Electronic Components

Click to view similar products for [Heavy Duty Power Connectors](#) category:

Click to view products by [Amphenol](#) manufacturer:

Other Similar products are found below :

[647757-1](#) [6643411-1](#) [6646058-2](#) [6646137-1](#) [6646138-1](#) [6646608-1](#) [6646786-1](#) [6646940-1](#) [6651091-1](#) [6651525-1](#) [6651529-1](#) [6651788-1](#)
[696475-1](#) [702-32-01109](#) [703-25-02205](#) [73000005059](#) [73000005642](#) [73080254296](#) [73080255059](#) [73080965046](#) [765-15-0080A](#)
[765-16-0080B](#) [765-18-0080D](#) [902-77-02113](#) [PS00/A0620/6300](#) [1221200000](#) [129-1J](#) [1409400](#) [E6374G1](#) [e6389g2](#) [157-43GW8](#) [MS3117-](#)
[14AC](#) [1643543-1](#) [1650540-1](#) [1651811-2](#) [1766260-1](#) [1766282-1](#) [1766966-1](#) [1791340000](#) [NLDFT-3-BL-L-S120-M40A](#) [NLDFT-N-W-L-](#)
[C240-M40B](#) [1926015-1](#) [NLS-N-W-C240-M40B](#) [2-1589900-8](#) [2199314-1](#) [KA8102](#) [9300480317](#) [29131](#) [294-0091-01100](#) [296-0040-01100](#)