

H4 PV Cable Connector

H4 Female Cable Connector

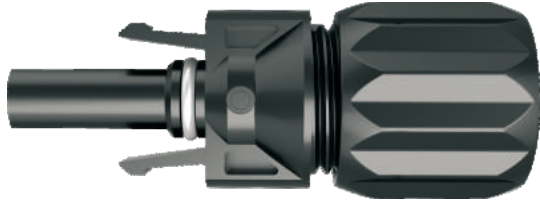

H4 Male Cable Connector



H4 Cold Formed Contact

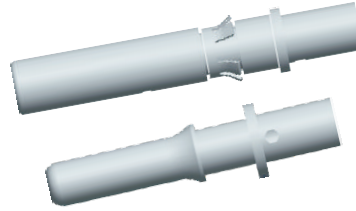

H4 Stamped and Formed Contact

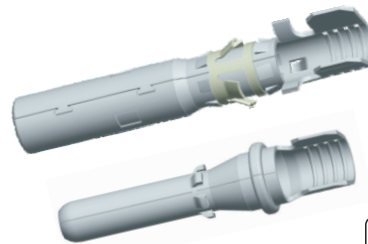

Features & Benefits

- UL 6703, 1500V DC & TUV 62852, 1000V DC, and CSA approved
- Long-term UV resistance
- High current rating in industry
- RoHS, REACH, Halogen-free compliant
- Low contact resistance means low loss

Technical Specification

Rated Voltage	UL	1500V DC per UL 6703
	TUV	1000V DC per IEC 62852, Class A Unrestricted Use
Rated Current(IEC85°C)	25A (2.5mm ² /14AWG), 35A (4.0mm ² / 12AWG), 45A (6.0mm ² /10AWG) ,65A (10mm ² / 8AWG)	
Rated Current(UL)	15A (2.5mm ² /14AWG), 20A (4.0mm ² / 12AWG), 30A (6.0mm ² /10AWG) ,50A (10mm ² / 8AWG)	
Rated Insulation Voltage	6kV for 1 minute(IEC)	
Rated impulse voltage	12kV (IEC)	
Contact System Options	Stamped and Formed (S&F) / Cold Formed (CF) contact, both with Amphenol's RADSOK® Insert	
Typical contract resistance	≤0.30mΩ for S&F contact, ≤0.25mΩ for CF contact, using Amphenol's low resistance RADSOK® contact technology	
Insulation material	Thermoplastic	
Contact Material	Tin-Plated Copper Alloy.	
Locking Mechanism	Meets 2014 NEC handbook 690.33(C), requirement for self-locking with tool-required unlock.	
Ingress Protection Ratings	IP68(1 meter, 1 hour) mated & IP2X touch-proof (reverse gender design)	
Flammability Classification	UL94, V-0	
Jacket of Cable Range	Ø4.5mm~Ø7.8mm	
Pollution Degree	2	
Over Voltage Category	CAT III	
Safety Class	Class II	
Ambient Temperature	-40°C to +85°C	
Upper Limiting	120°C	
RoHS and Halogen Free	Compliance	
UV Resistance	Outdoor suitable (f1) rated materials, per UL 746C	



R 50388083



E 339277



250535

Assembly Tool:



Tool-kit H4TK0000



Unlock Tool H4TU0000



Wrench Tool H4TW0001



Strip Tool H4TS0000



Crimp Tool for S&F contact H4TC0002 for C&F contact H4TC0001



New Crimp Tool for S&F contact H4TC0003 for C&F contact UTXTC0004



Inspection Tool H4TT0001

NOTES:

* THIS DOCUMENT CONTAINS PROPRIETARY INFORMATION AND SUCH INFORMATION MAY NOT BE DISCLOSED TO OTHERS FOR ANY PURPOSE OR USED FOR MANUFACTURING PURPOSES WITHOUT WRITTEN PERMISSION FROM THE AMPHENOL CORP.

www.amphenol-solar.com

ASIA

Amphenol Technology (Shenzhen) Co., Ltd.
Building C, 2nd Industrial Zone of Xia Shi Jia
Gongming Sub-district, Guangming New district
Shenzhen, China 518106
Tel: +86-755-29918389

NORTH AMERICA

Amphenol Industrial Operations
191 Delaware Avenue
Sidney, New York 13838-1395 USA
Tel: +1-888-364-9011
Amphenol Industrial Solar Technologies
180N Freeport DR.W-10, Nogales AZ 85621-2423
Tel: +1-520-397-7047

EUROPE & THE MIDDLE EAST

Amphenol Industrial Operations Europe
Via Barbaiana 51-20020 Lainate (MI) Italy
Tel: +39-348-3145390
Amphenol Industrial Operations Middle East
Office C-37 PO Box 21107
Ajman Free Zone, UAE
Tel: +39-348-3145390

H4 PV Cable Connector

Product Dimensions

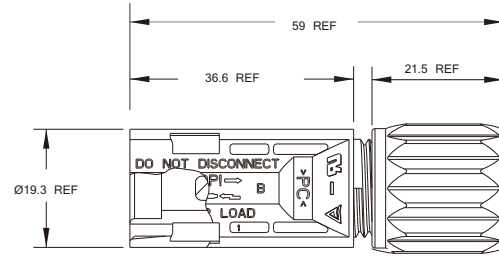
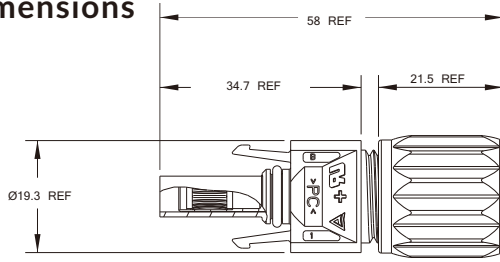

H4 Stamped and Formed Contact

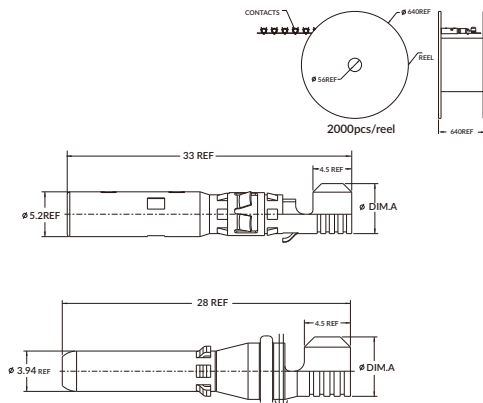

H4 Cold Formed Contact

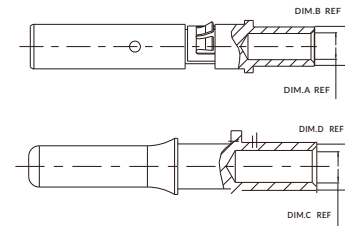

Accept wire conductor size mm ² (AWG)	"A"
2.5(14)	4.80
4&6(12&10)	5.80

Accept wire conductor size mm ² (AWG)	"A"	"B"	"C"	"D"
2.5(14)	2.30	3.5	2.3	3.5
4.0(12)	3.05	4.57	3.05	4.57
4&6(12&10)	3.4	4.6	3.4	4.6
6.0(10)	3.7	6.00	3.7	6.00
10.0(8)	4.5	6.00	4.5	6.00

How to Order

How to order a connector (Please choose one code per position)

Product family	Product Type	Gender	Connector Type	Cable Size	Approvals
H4 Helios H4	C Connector	F Female M Male	C Cable gland	2 2.5mm ² /14 AWG 4 4.0mm ² /12 AWG& 6.0mm ² /10 AWG (S&F) 4.0mm ² /12 AWG (CF) 6 6.0mm ² /10 AWG (CF) 8 10.0mm ² /8 AWG (CF) 0 Less contacts	D Dual TUV/UL Certified
Packaging		Contact			
I 1pcs/bag, 800pcs/box C 100pcs/bag, 10 bags/box M 500pcs/bag, 2 bags/box		S S&F Contact Blank CF Contact			

Order Example:

H4CFC4DMS: H4 cable connector, female, 4.0mm²/12 AWG & 6.0mm²/10 AWG S&F contact, 1000pcs per box
H4CFC4DM: H4 cable connector, female, 4.0mm²/12 AWG CF contact, 1000pcs per box

How to order S&F Contacts on Reels (Please choose one code per position)

Product family	Contact Type	Gender	Cable Size	Packing
H4 Helios H4	F S&F contact	F Female M Male	2 1.5mm ² /16 AWG&2.5mm ² /14 AWG 4 4.0mm ² /12 AWG&6.0mm ² /10 AWG	R 2000pcs/reel

Note: If ordering contacts in 2000pcs/reel version, need to order contact and plastic housing separately. contact ordering code refers to this table.

Order Example:

H4CFC0DM: H4 Cable connector, Female, housing assembly, 1pcs.
H4CMC0TM: H4 Cable connector, Male, housing assembly, 1 pcs.
H4FF4R: H4 female contact on reel, 4.0mm²/12 AWG & 6.0mm²/10 AWG , 2000pcs/reel.
H4FM2R: H4 male contact on reel, 2.5mm²/14 AWG , 2000pcs/reel.

NOTES:

* THIS DOCUMENT CONTAINS PROPRIETARY INFORMATION AND SUCH INFORMATION MAY NOT BE DISCLOSED TO OTHERS FOR ANY PURPOSE OR USED FOR MANUFACTURING PURPOSES WITHOUT WRITTEN PERMISSION FROM THE AMPHENOL CORP.

ASIA

Amphenol Technology (Shenzhen) Co., Ltd.
Building C, 2nd Industrial Zone of Xia Shi Jia
Gongming Sub-district, Guangming New district
Shenzhen, China 518106
Tel: +86-755-29918389

NORTH AMERICA

Amphenol Industrial Operations
191 Delaware Avenue
Sidney, New York 13838-1395 USA
Tel: +1-888-364-9011
Amphenol Industrial Solar Technologies
180N Freeport DR.W-10, Nogales AZ 85621-2423
Tel: +1-520-397-7047

EUROPE & THE MIDDLE EAST

Amphenol Industrial Operations Europe
Via Barbaiana 51-20020 Lainate (MI) Italy
Tel: +39-348-3145390
Amphenol Industrial Operations Middle East
Office C-37 PO Box 21107
Ajman Free Zone, UAE
Tel: +39-348-3145390

X-ON Electronics

Largest Supplier of Electrical and Electronic Components

Click to view similar products for [Crimpers / Crimping Tools](#) category:

Click to view products by [Amphenol](#) manufacturer:

Other Similar products are found below :

[010-0096](#) [M225202-37](#) [6-1579015-5](#) [CT150-2-D02](#) [M322](#) [6-304052-1](#) [63456-0054](#) [63484-3701](#) [63800-8355](#) [63819-1875](#) [63819-2875](#)
[63819-4475](#) [63823-3475](#) [63827-5375](#) [64001-0975](#) [64001-4175](#) [64005-0175](#) [662903-2](#) [690602-6](#) [7-1579001-9](#) [7-23471-1](#) [762637-1](#) [808714-](#)
[1](#) [811242-5](#) [999-50-020083](#) [1-21002-3](#) [1-21002-7](#) [12085270](#) [1-21002-6](#) [1-21113-6](#) [1-22548-4](#) [125442-1](#) [DCE.91.073.BVC](#)
[DCE.91.090.3MVM](#) [DCE.91.130.5MVU](#) [DCE.91.202.BVCM](#) [1338300-1](#) [1-354003-0](#) [1338301-1](#) [DF62/RE-MD](#) [142321](#) [1456088-1](#)
[1490794-1](#) [1-45804-6](#) [1490357-2](#) [1490357-3](#) [AX100749](#) [1-59619-7](#) [1596970-1](#) [1-59619-8](#)