

THIS DOCUMENT IS SUBJECT TO CHANGE WITHOUT NOTICE. IT IS CONFIDENTIAL AND A PROPERTY OF Amphenol LTW. DISCLOSURE TO THIRD PARTY HAS TO BE AUTHORIZED BY Amphenol LTW.

REV.	ECN NO.	DATE	SIGN	DESCRIPTION
A	Initial Release	2018/01/13	Ethan	Chnage Rev.01 To Rev.A

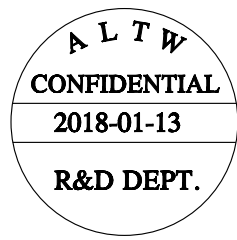
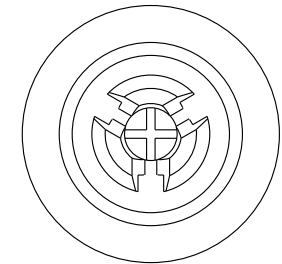
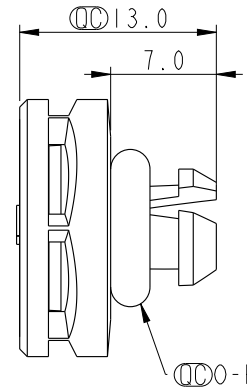
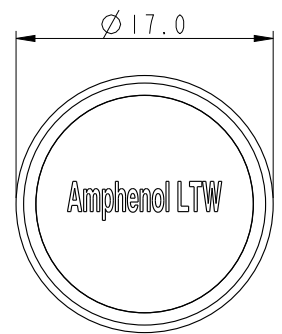
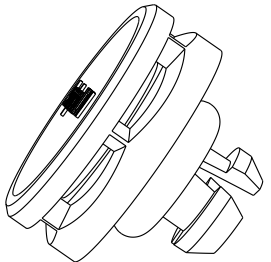

成品料號(Product no.)	透氣量ml/min@70mbar	主體顏色(Body Colour)	O-Ring Color	疏油性(Oleophobic)	Waterproof Rate
VENT-PQINGY-08001	>550	Gray	Black	Y	IP68/IP69K
VENT-PQINBK-08001	>550	Black	Black	Y	IP68/IP69K
VENT-PQINGY-N8001	>1000	Gray	Blue	N	IP68/IP69K
VENT-PQINBK-N8001	>1000	Black	Blue	N	IP68/IP69K
VENT-PQINGY-08002	>1000	Gray	Green	Y	IP68/IP69K
VENT-PQINBK-08002	>1000	Black	Green	Y	IP68/IP69K
VENT-PQINGY-N8002	>3000	Gray	Red	N	IP68/IP69K
VENT-PQINBK-N8002	>3000	Black	Red	N	IP68/IP69K

UNIT : mm			TITLE SNAP VENT
TOLERANCE .X ±0.25 .XX ±0.1 .XXX ±0.05 ANGLES ±1°	SCALE 2:1	SIZE A4	SHEET 1 OF 2
REV. A	WC-REV. A.7	◎◎: Inspection item	

**Amphenol LTW**  
安費諾亮泰企業股份有限公司

ITEM NO	DRAWN BY Ethan	DATE 2018-01-13
DWG NO VENT-PQIXXX-XXXXX	CHECKED BY Feng-li	DATE 2018-01-13
CUSTOMER ALTW	APPROVED BY Jerry	DATE 2018-01-13

THIS DOCUMENT IS SUBJECT TO CHANGE WITHOUT NOTICE. IT IS CONFIDENTIAL AND A PROPERTY OF Amphenol LTW. DISCLOSURE TO THIRD PARTY HAS TO BE AUTHORIZED BY Amphenol LTW.

REV.	ECN NO.	DATE	SIGN	DESCRIPTION

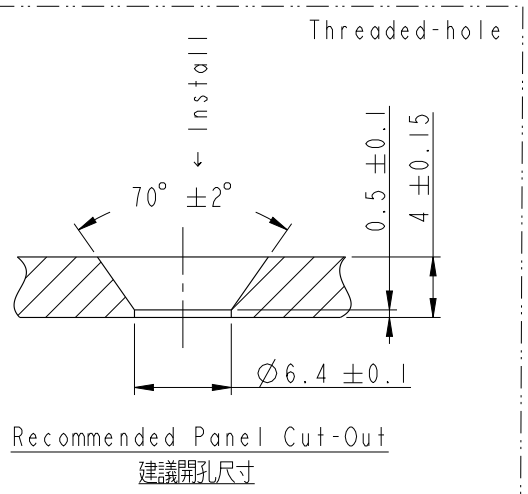
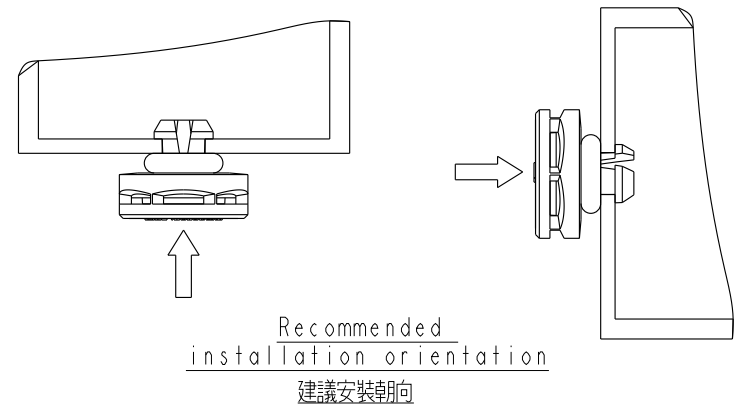

**ALTW**  
**CONFIDENTIAL**  
**2018-01-13**  
**R&D DEPT.**

- Note:
- \*  $\varnothing$  Important Dimension.
  - \* Cap: Nylon, 94V-0, UV Resistance, UL
  - \* Membrane: ePTFE
  - \* Body: Nylon, 94V-0, UV Resistance, UL
  - \* O-Ring: Silicone, 94V-0, UL

UNIT: mm TOLERANCE .X $\pm 0.25$ .XX $\pm 0.1$ .XXX $\pm 0.05$ ANGLES $\pm 1^\circ$		TITLE		ITEM NO	DRAWN BY	DATE
		SNAP VENT		DWG NO	Ethan	2018-01-13
		SCALE	SIZE	SHEET	CHECKED BY	DATE
2:1	A4	2 OF 2	Feng-li	2018-01-13		
REV.	WC-REV.	QC	APPROVED BY	DATE		
A	A.7	$\varnothing$ : Inspection item	Jerry	2018-01-13		
<b>Amphenol LTW</b> <b>安費諾亮泰企業股份有限公司</b>			CUSTOMER	DATE		
			ALTW			

## X-ON Electronics

Largest Supplier of Electrical and Electronic Components

*Click to view similar products for [Circular Metric Connectors](#) category:*

*Click to view products by [Amphenol](#) manufacturer:*

Other Similar products are found below :

[600X518037X](#) [MA1EAF1200](#) [6STD09SAM99B70X](#) [8R4A00A18M020](#) [1300140094](#) [130203-0054](#) [1300150099](#) [1-3637-600-5205](#) [1545399](#)  
[1A4000-348](#) [8R4006A16M010](#) [8R5006A18A120](#) [1R3006A20M005](#) [RF-12P1N8A80DU](#) [RF-12P1N8A90DU](#) [41-01016](#) [41-40010](#) [41-40011](#)  
[41-40017](#) [42-01015](#) [4-22279-4](#) [4-22281-1](#) [4-22284-9](#) [43-10041](#) [41-40005](#) [41-40016](#) [43-00132](#) [XS3P-M421-2](#) [600X518050X](#) [SACC-DSI-](#)  
[FS-5P-PG9-L180 SC](#) [8R4000A16M010](#) [1R3004A20A1201](#) [N03FA03144](#) [1300140077](#) [41-01117](#) [XS2RD4265](#) [RSC 4/9](#) [XS2R-D426-1](#)  
[XS8A-0441](#) [859RD04-103R004](#) [860RD04-113R004](#) [860-X08-213R004](#) [1-213245-2](#) [2273142-2](#) [LC20-02PMFS-SW8001](#) [1604360](#)  
[21031121405](#) [MSAS-12PMMP-SF8001](#) [8P-04BFFB-SL7001](#) [21038122406](#)