

# AS1331

## 300mA Buck-Boost Synchronous DC/DC Converter

### General Description

This special device is a synchronous buck-boost DC/DC converter which can handle input voltages above, below, or equal to the output voltage.

Due to the internal structure of the AS1331 which is working continuously through all operation modes this device is ideal for dual or triple cell alkaline/NiCd/NiMH as well as single cell Li-Ion battery applications.

Because of the implemented Power Save Mode, the solution footprint and the component count is minimized and also over a wide range of load currents a high conversion efficiency is provided.

The device includes two N-channel MOSFET switches and two P-channel switches. Also following features are implemented: a quiescent current of typically 22µA (ideal for battery power applications), a shutdown current less than 1µA, current limiting, thermal shutdown and output disconnect.

The AS1331 is available in a 10-pin 3x3mm TDFN package with fixed and adjustable output voltage.

*Ordering Information and Content Guide appear at end of datasheet.*

### Key Benefits & Features

The benefits and features of AS1331, 300mA Buck-Boost Synchronous DC/DC Converter are listed below:

**Figure 1:**  
Added Value of Using AS1331

Benefits	Features
<ul style="list-style-type: none"> <li>Ideal for single Li-Ion battery powered applications</li> </ul>	<ul style="list-style-type: none"> <li>Input voltage range: 1.8V to 5.5V</li> </ul>
<ul style="list-style-type: none"> <li>Supports a variety of end applications</li> </ul>	<ul style="list-style-type: none"> <li>Output voltage range: 2.5V to 3.3V</li> <li>Output current: 300mA @ 3.3V</li> <li>Automatic transition between buck and boost mode</li> </ul>
<ul style="list-style-type: none"> <li>Built-in self-protection</li> </ul>	<ul style="list-style-type: none"> <li>Short-circuit protection</li> <li>Overtemperature protection</li> <li>Output disconnection in shutdown</li> </ul>
<ul style="list-style-type: none"> <li>Small system area</li> </ul>	<ul style="list-style-type: none"> <li>10-pin 3x3mm TDFN package</li> </ul>

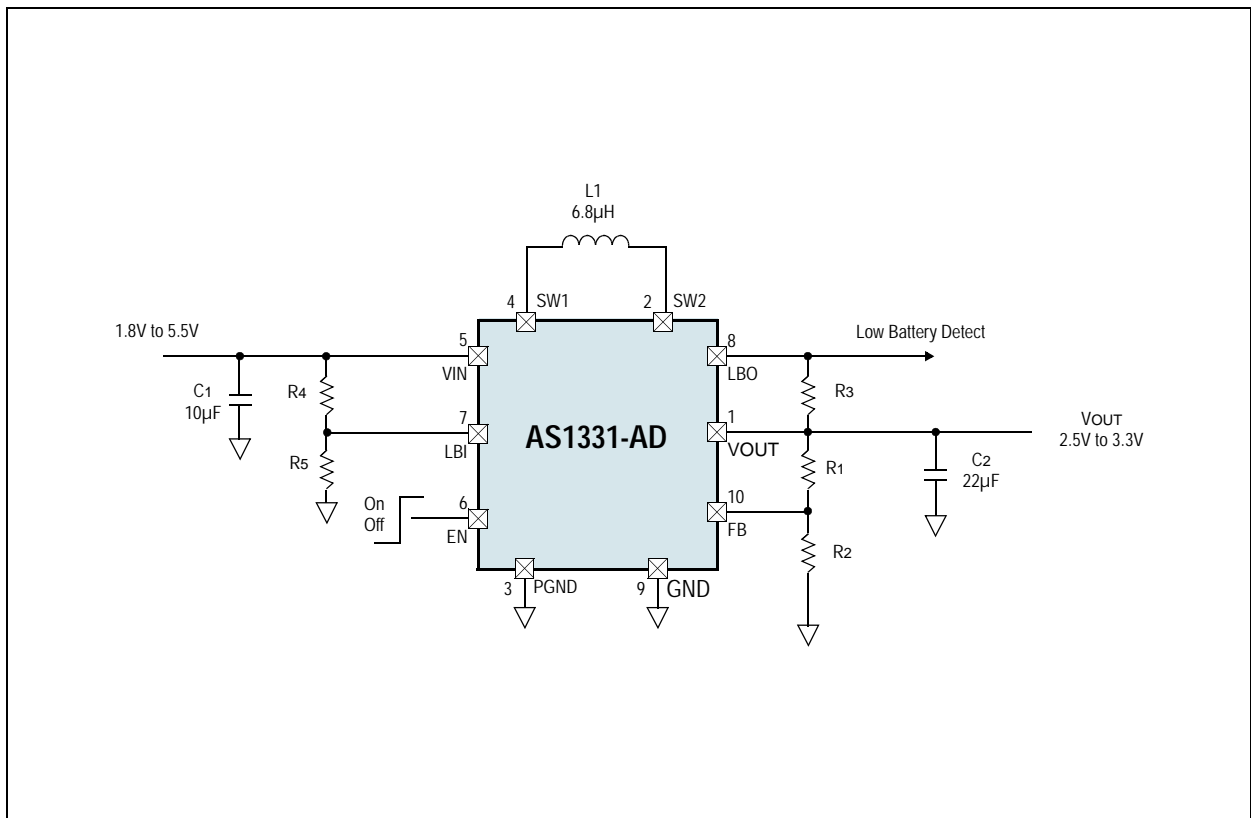
### Applications

The AS1331 is an ideal solution for handheld computers, handheld instruments, portable music players and PDA's. Two and three cell Alkaline, NiCd or NiMH or single cell Li battery powered products.

### Block Diagram

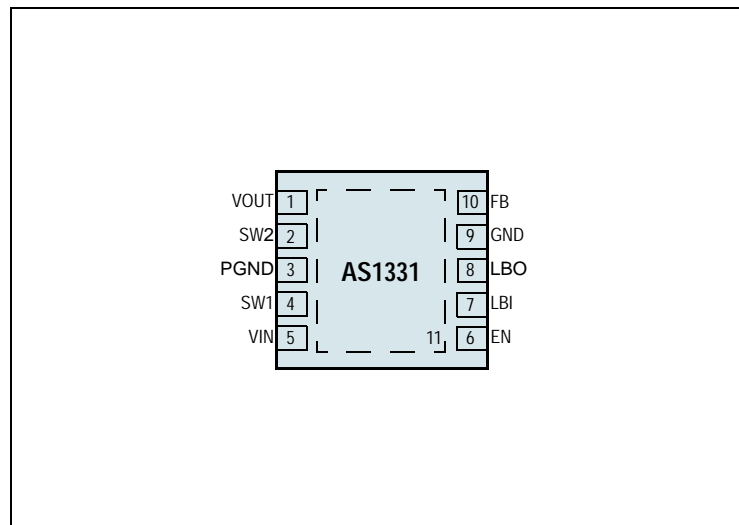
The functional blocks of this device are shown below:

**Figure 2:**  
Typical Application Diagram



## Pin Assignment

**Figure 3:**  
Pin Diagram (Top View)



**Figure 4:**  
Pin Description

Pin Name	Pin Number	Description
VOUT	1	<b>Output of the Buck/Boost Converter.</b>
SW1	2	<b>Buck/Boost Switch Pin.</b> Connect the inductor from SW1 to SW2.
PGND	3	<b>Power Ground.</b> Both GND pins must be connected.
SW2	4	<b>Buck/Boost Switch Pin.</b> Connect the inductor from SW1 to SW2. An optional Schottky diode can be connected between this pin and VOUT to increase efficiency.
VIN	5	<b>Input Supply Pin.</b> A minimum 2.2 $\mu$ F capacitor should be placed between VIN and GND.
EN	6	<b>Enable Pin.</b> Logic controlled shutdown input. 1 = Normal operation 0 = Shutdown; quiescent current < 1 $\mu$ A VIN must be present and stable before EN operation is valid during start-up.
LBI	7	<b>Low Battery Comparator Input.</b> 1.25V Threshold. May not be left floating. If connected to GND LBO is working as Output Power okay.

Pin Name	Pin Number	Description
LBO	8	<b>Low Battery Comparator Output.</b> This open-drain output is low when the voltage on LBI is less than 1.25V.
GND	9	<b>Ground.</b> Both GND pins must be connected.
FB	10	<b>Feedback Pin.</b> Feedback input for the adjustable version. Connect a resistor divider tap to this pin. The output voltage can be adjusted from 2.5V to 3.3V by: $V_{OUT} = 1.25V[1 + (R_1/R_2)]$ . <sup>(1)</sup>
NC	11	<b>Exposed Pad.</b> This pad is not connected internally. It can be used for ground connection between GND and PGND.

**Note(s):**

1. For the fixed Output Voltage Version contact this pin to VOUT.

## Absolute Maximum Ratings

Stresses beyond those listed in Absolute maximum Ratings may cause permanent damage to the device. These are stress ratings only, and functional operation of the device at these or any other conditions beyond those indicated in [Electrical Characteristics](#) is not implied. Exposure to absolute maximum rating conditions for extended periods may affect device reliability.

**Figure 5:**  
Absolute Maximum Ratings

Parameter	Min	Max	Units	Notes
SW1, SW2, VIN, VOUT, EN	-0.3	+7	V	
PGND to GND	-0.3	+0.3	V	
SW1, SW2	-0.3	+7	V	
Electrostatic Discharge ESD	±4		kV	<i>HBM MIL-Std. 883E 3015.7 methods</i>
Thermal Resistance $\theta_{JA}$	+33		°C/W	
Junction Temperature	150		°C	
Operating Temperature Range	-40	85	°C	
Storage Temperature Range	-65	125	°C	
Package Body Temperature	260		°C	The reflow peak soldering temperature (body temperature) specified is in accordance with <i>IPC/JEDEC J-STD-020D "Moisture/Reflow Sensitivity Classification for Non-Hermetic Solid State Surface Mount Devices"</i> . The lead finish for Pb-free leaded packages is matte tin (100% Sn).
Relative humidity (non-condensing)	5	85	%	
Moisture sensitivity level	1			Unlimited floor life time

## Electrical Characteristics

All limits are guaranteed. The parameters with min and max values are guaranteed with production tests or SQC (Statistical Quality Control) methods.

$V_{IN} = 3.6V$ ,  $V_{OUT} = 3.3V$ ,  $T_{AMB} = -40^{\circ}C$  to  $85^{\circ}C$ . Typical values are at  $T_{AMB} = 25^{\circ}C$ . Unless otherwise specified.

**Figure 6:**  
Electrical Characteristics

Symbol	Parameter	Conditions	Min	Typ	Max	Units
<b>Input</b>						
$V_{IN}$	Input voltage range		1.8		5.5	V
	Minimum startup voltage	$I_{LOAD} < 1mA$		1.6	1.8	V
$V_{UV}$	Undervoltage lockout threshold <sup>(1)</sup>	$V_{IN}$ decreasing	1.5	1.6	1.7	V
<b>Regulation</b>						
$V_{OUT}$	Output voltage adjustable version		2.50		3.30	V
	Output voltage 3.3V	No Load	3.201	3.3	3.399	V
	Output voltage 3.0V		2.910	3.0	3.090	V
	Output voltage 2.5V		2.425	2.5	2.575	V
$V_{FB}$	FB voltage adjustable version	No Load	1.212	1.25	1.288	V
$I_{FB}$	FB input current adjustable version	$V_{FB} = 1.3V$ , $T_{AMB} = 25^{\circ}C$		1	100	nA
	$V_{OUT}$ lockout threshold <sup>(2)</sup>	Rising Edge	2.0	2.15	2.3	V
<b>Operating Current</b>						
IQ	Quiescent current $V_{IN}$	$V_{IN} = 5V$		2	6	$\mu A$
	Quiescent current $V_{OUT}$	$V_{IN} = 5V$ , $V_{OUT} = 3.6V$ , $V_{FB} = 1.3V$		20	32	$\mu A$
$I_{SHDN}$	Shutdown current	$EN = 0V$ , $V_{OUT} = 0V$ , $T_{AMB} = 25^{\circ}C$		0.01	1	$\mu A$

Symbol	Parameter	Conditions	Min	Typ	Max	Units
<b>Switches</b>						
$I_{MOS}$	MOS switch leakage	$V_{IN} = 5V, T_{AMB} = 25^{\circ}C,$ Switches A-D		0.01	1	$\mu A$
$R_{ON}$	NMOS B, C	$V_{IN} = 5V$		0.13		$\Omega$
	PMOS A	$V_{IN} = 5V$		0.17		$\Omega$
	PMOS D	$V_{OUT} = 3.3V$		0.21		$\Omega$
$I_{PEAK}$	Peak current limit	$L = 6.8\mu H, V_{IN} = 5V$	450	600	750	mA
<b>Enable</b>						
$V_{ENH}$	EN input high		1.4			V
$V_{ENL}$	EN input low				0.4	V
$I_{EN}$	EN input current	$EN = 5.5V, T_{AMB} = 25^{\circ}C$		1	100	nA
<b>Low Battery and Power-OK</b>						
$V_{LBI}$	LBI Threshold	Falling Edge	1.212	1.25	1.288	V
	LBI Hysteresis			10		mV
	LBI Leakage current	$LBI = 5.5V, T_{AMB} = 25^{\circ}C$		1	100	nA
	LBO Voltage low <sup>(3)</sup>	$I_{LBO} = 1mA$		0.05	0.2	V
	LBO Leakage current	$LBO = 5.5V, T_{AMB} = 25^{\circ}C$		1	100	nA
	Power-OK threshold	$LBI = 0V,$ falling edge	90	92.5	95	%
<b>Thermal Protection</b>						
	Thermal shutdown	10°C hysteresis		145		°C

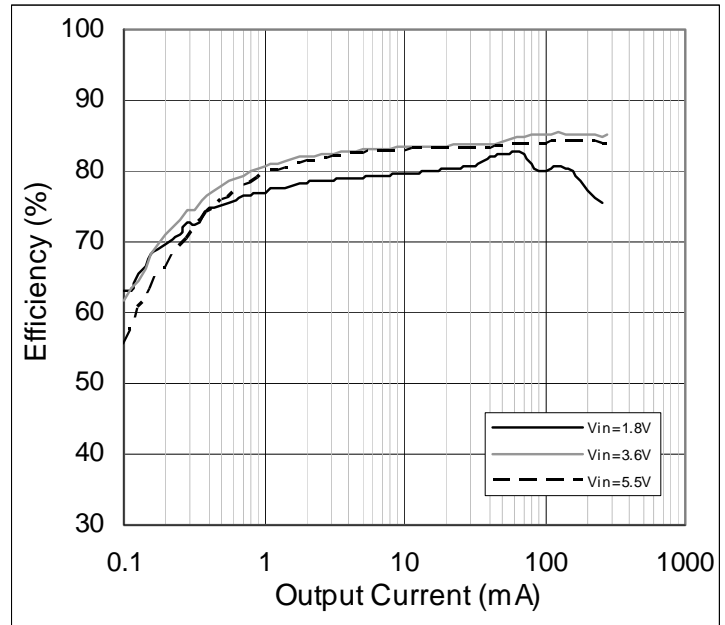
**Note(s):**

1. If the input voltage falls below this value during normal operation the device goes in startup mode.
2. The regulator is in startup mode until this voltage is reached. Caution: Do not apply full load current until the device output > 2.3V.
3. LBO goes low in startup mode as well as during normal operation if:
  - 1) The voltage at the LBI pin is below LBI threshold.
  - 2) The voltage at the LBI pin is below 0.1V and  $V_{OUT}$  is below 92.5% of its nominal value.

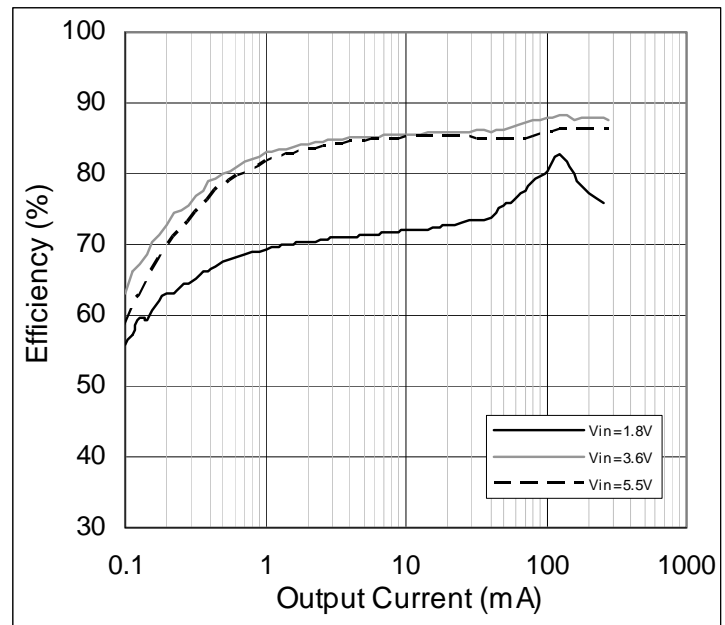
**Typical Operating Characteristics**

Circuit of Figure 29,  $V_{IN} = 2.4V$ ,  $V_{OUT} = 3.3V$ ,  $T_{AMB} = 25^{\circ}C$ , unless otherwise specified.

**Figure 7:**  
Efficiency vs. Output Current;  $V_{OUT} = 2.5V$

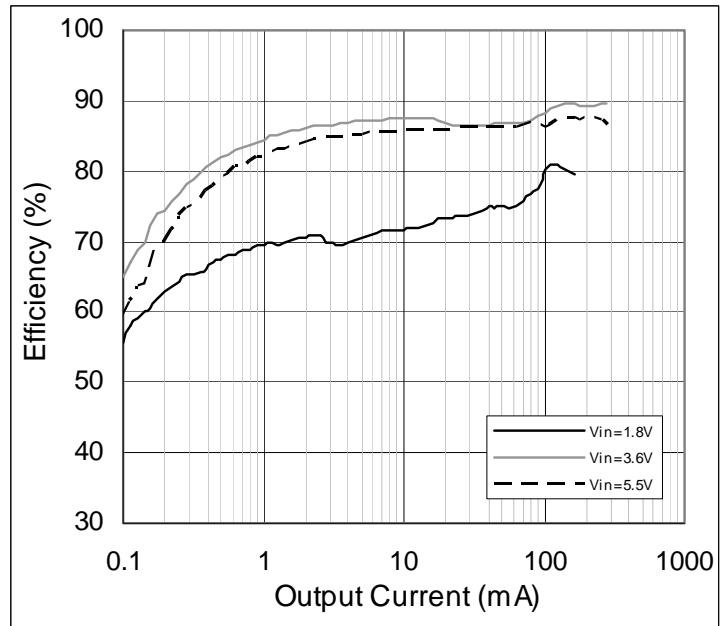


**Figure 8:**  
Efficiency vs. Output Current;  $V_{OUT} = 3.0V$

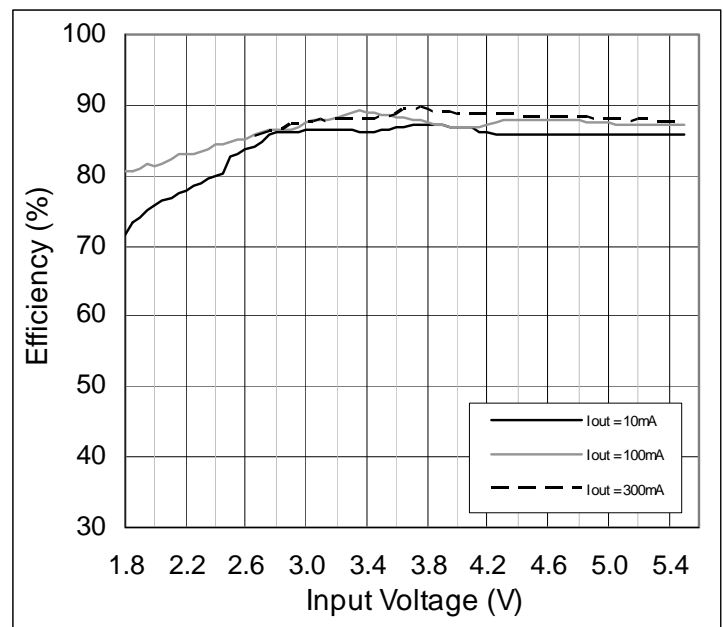




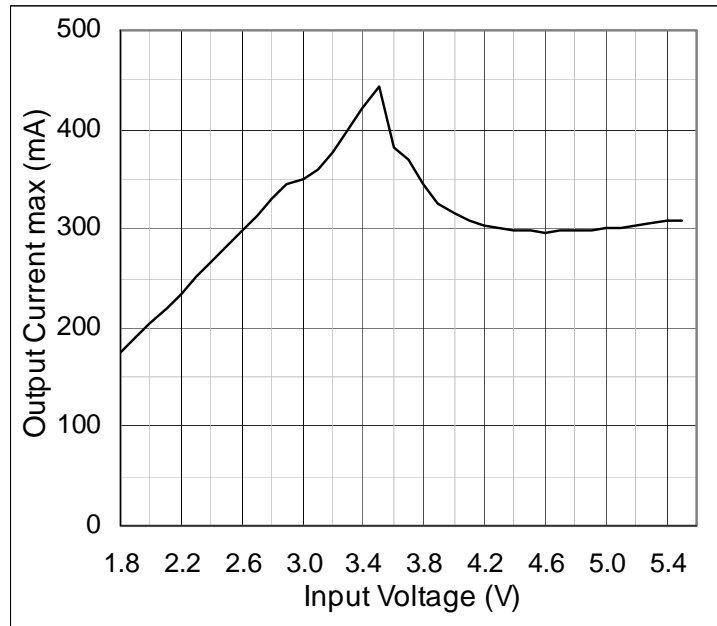
**Figure 9:**  
**Efficiency vs. Output Current;  $V_{OUT} = 3.3V$**



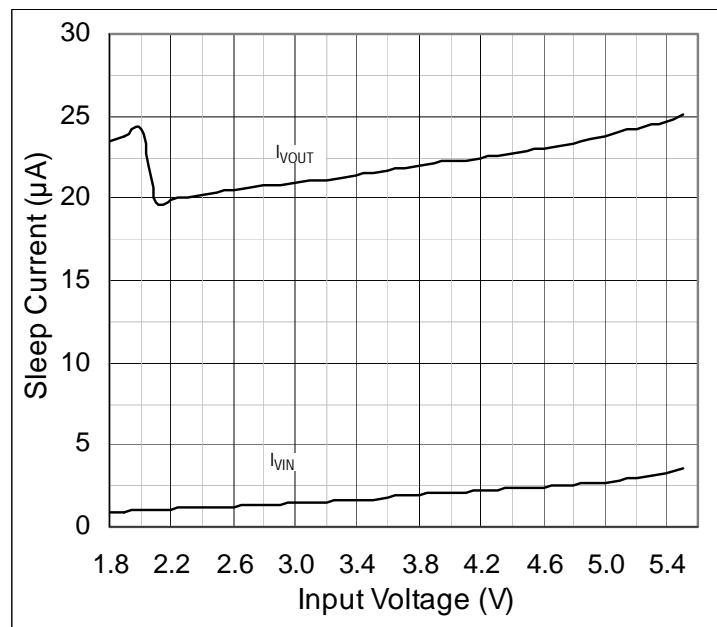
**Figure 10:**  
**Efficiency vs. Input Voltage**



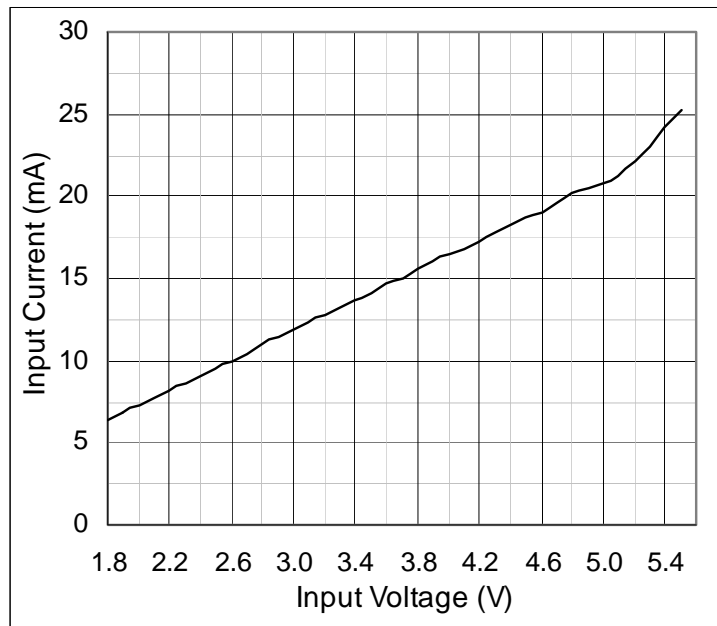
**Figure 11:**  
 $I_{OUT}$  Max vs. Input Voltage



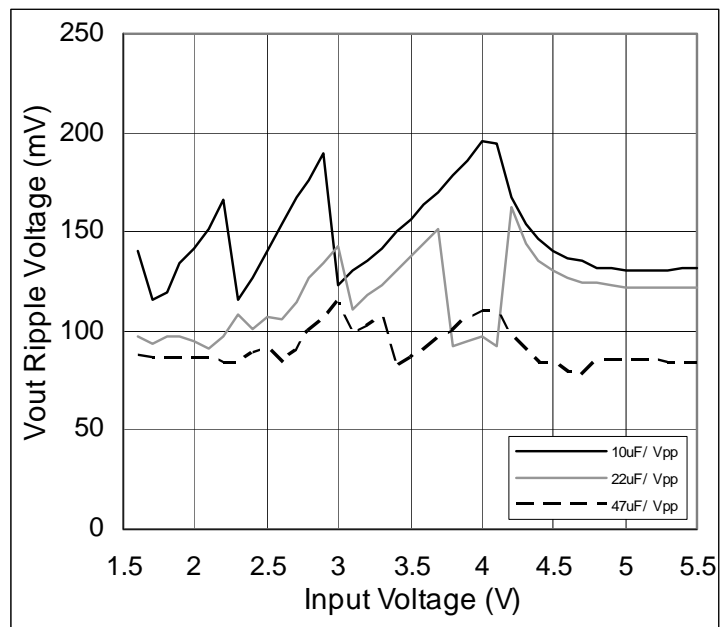
**Figure 12:**  
 Sleep Currents vs. Input Voltage



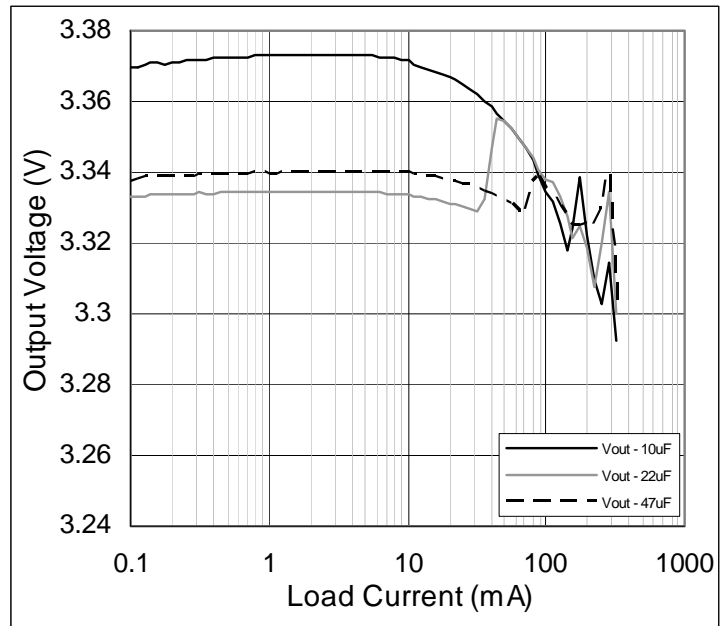
**Figure 13:**  
 $I_{IN}$  Short Circuit vs. Input Voltage



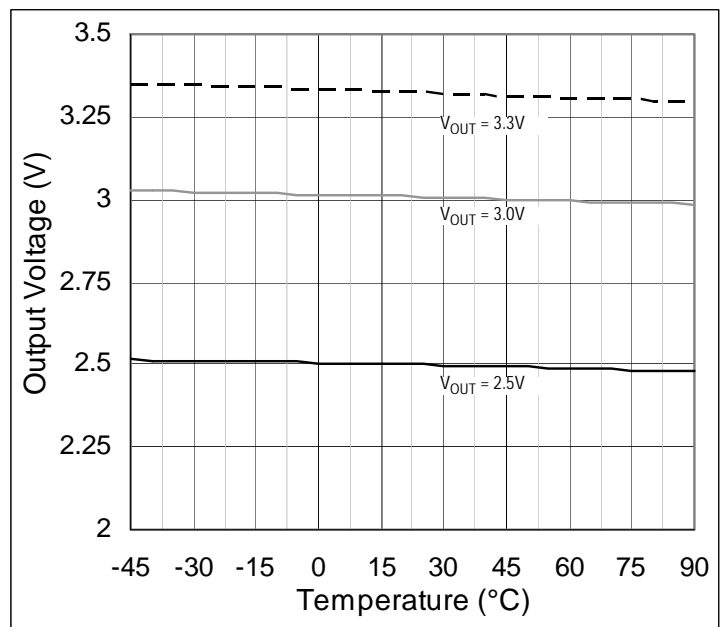
**Figure 14:**  
 $V_{OUT}$  Ripple vs. Input Voltage



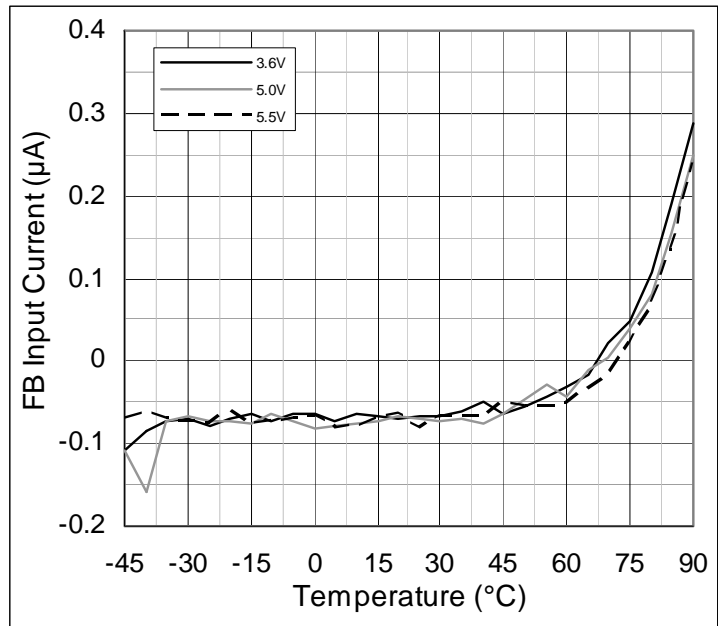
**Figure 15:**  
Load Regulation vs. Load Current



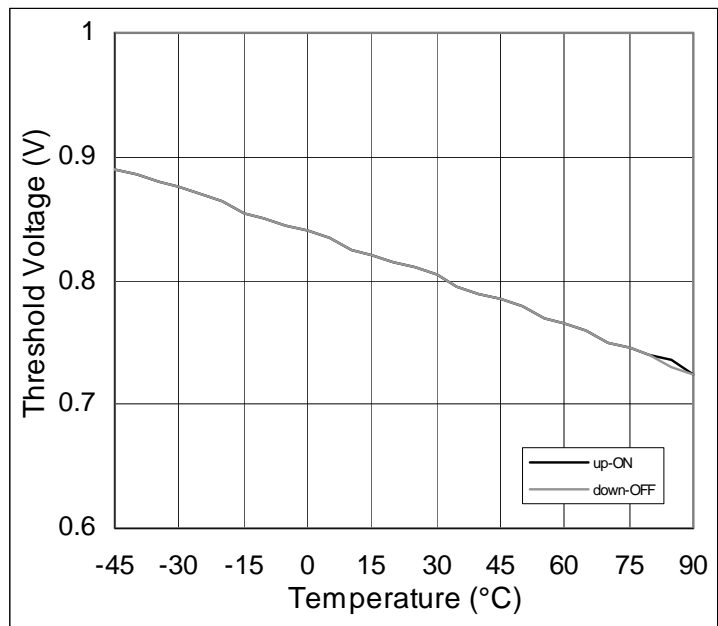
**Figure 16:**  
V<sub>OUT</sub> Regulation vs. Temperature



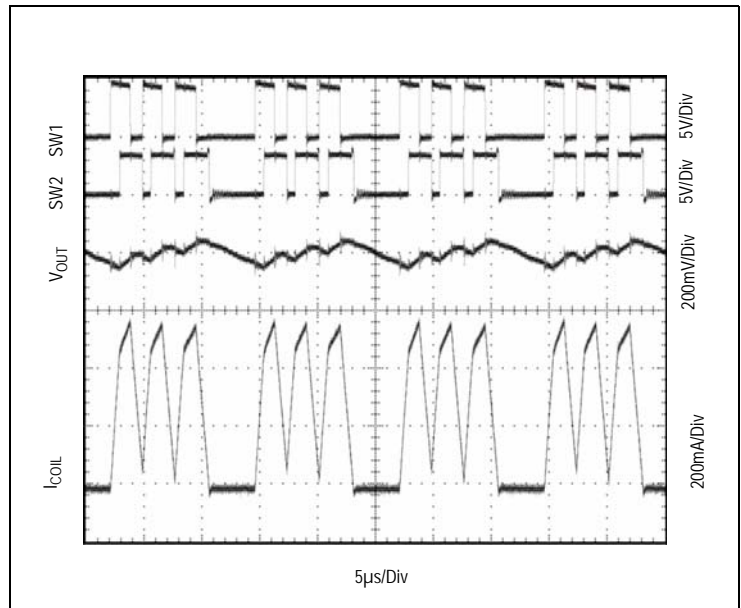
**Figure 17:**  
 $I_{FB}$  vs. Temperature;  $V_{IN} = 5V$



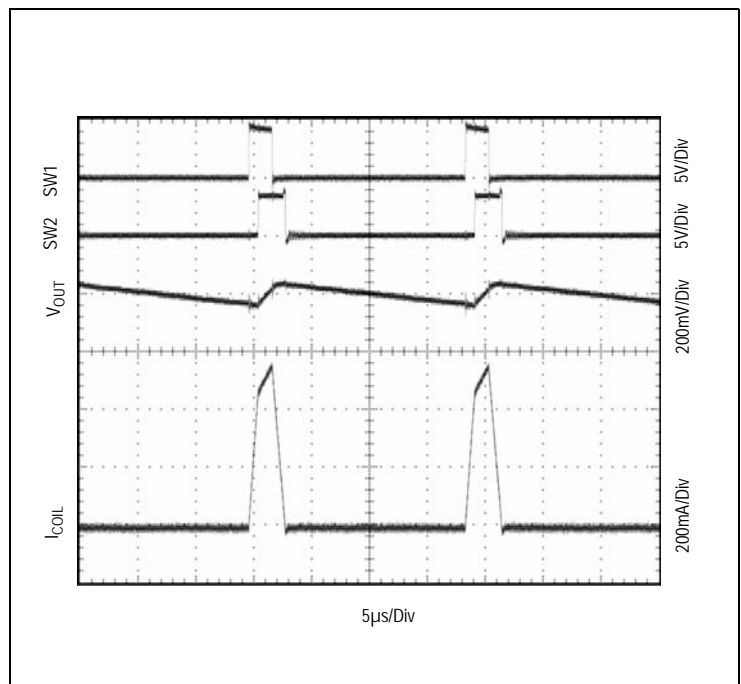
**Figure 18:**  
 EN Pin Threshold



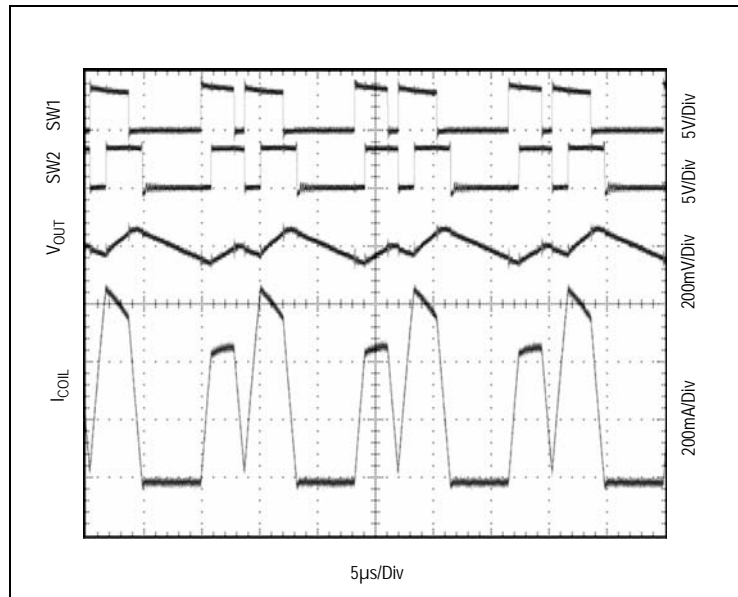
**Figure 19:**  
 $V_{IN} = 4.4V$ ,  $V_{OUT} = 3.3V$ ,  $I_{OUT} = 200mA$



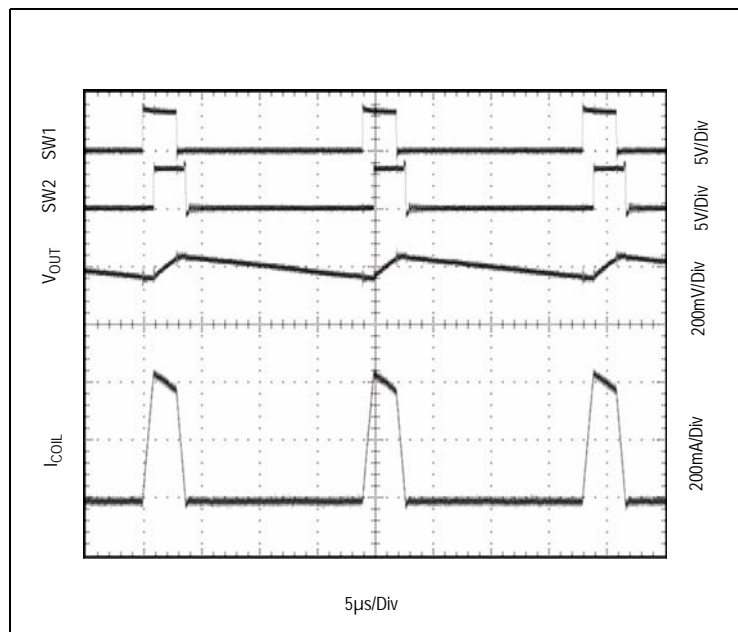
**Figure 20:**  
 $V_{IN} = 4.4V$ ,  $V_{OUT} = 3.3V$ ,  $I_{OUT} = 50mA$



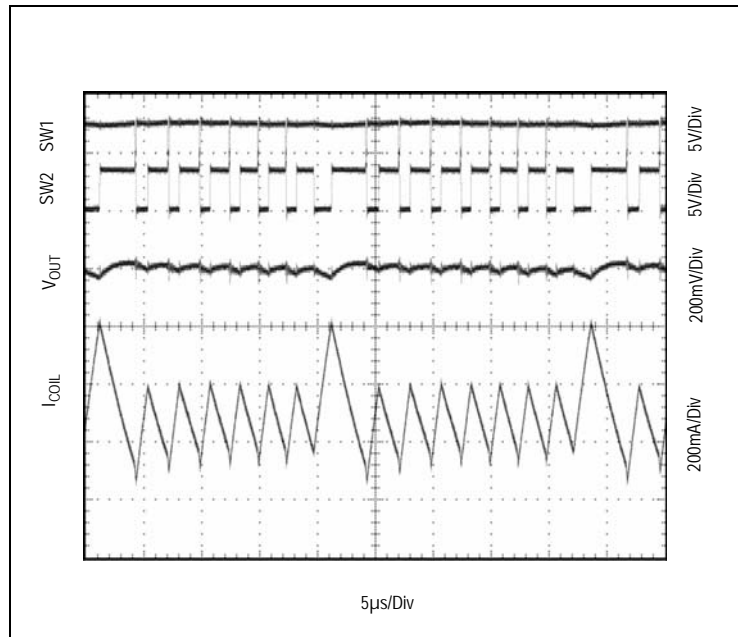
**Figure 21:**  
 $V_{IN} = 3.6V, V_{OUT} = 3.3V, I_{OUT} = 200mA$



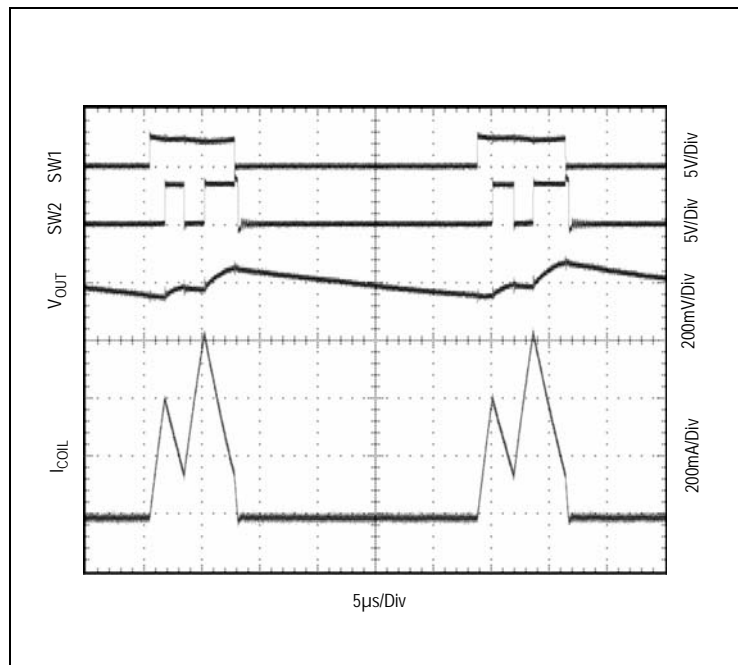
**Figure 22:**  
 $V_{IN} = 3.6V, V_{OUT} = 3.3V, I_{OUT} = 50mA$



**Figure 23:**  
 $V_{IN} = 2.5V, V_{OUT} = 3.3V, I_{OUT} = 200mA$

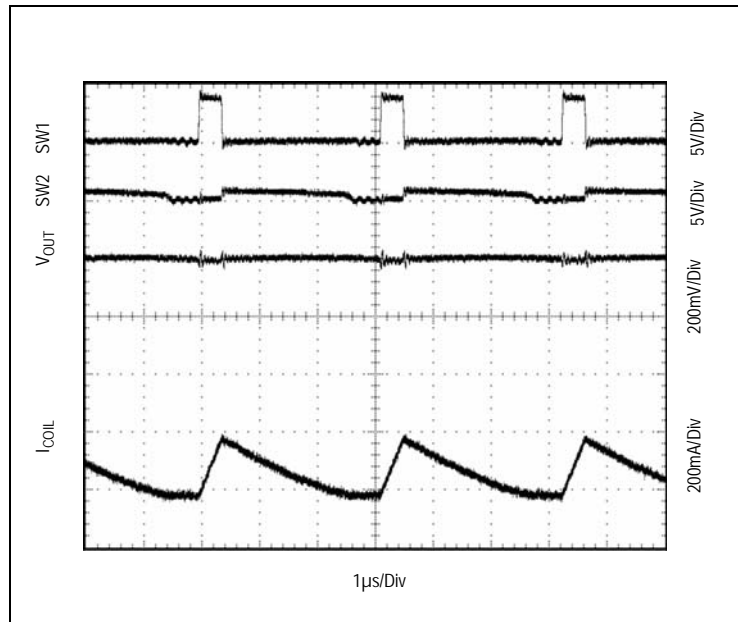


**Figure 24:**  
 $V_{IN} = 2.5V, V_{OUT} = 3.3V, I_{OUT} = 50mA$

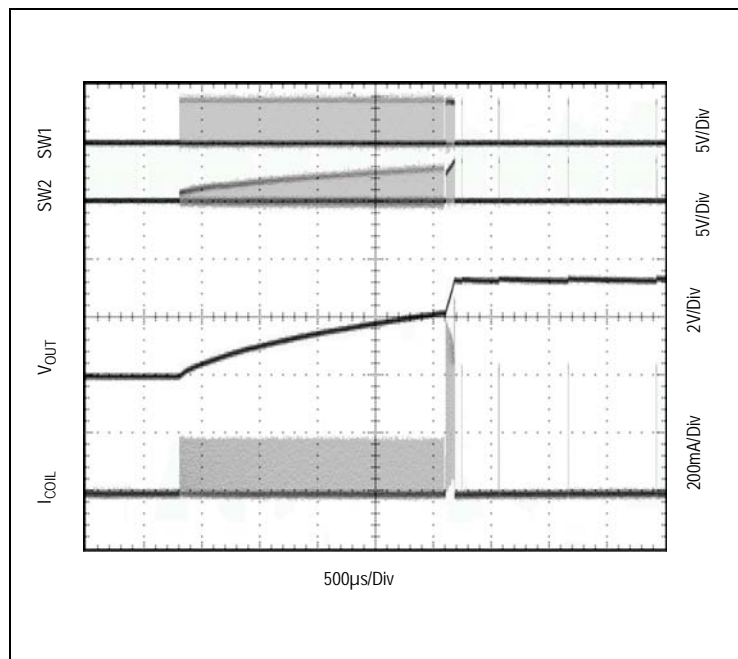




**Figure 25:**  
Shorted Output;  $V_{IN} = 3.6V$



**Figure 26:**  
Startup;  $V_{IN} = 3.6V$ ,  $R_{load} = 3.3k\Omega$

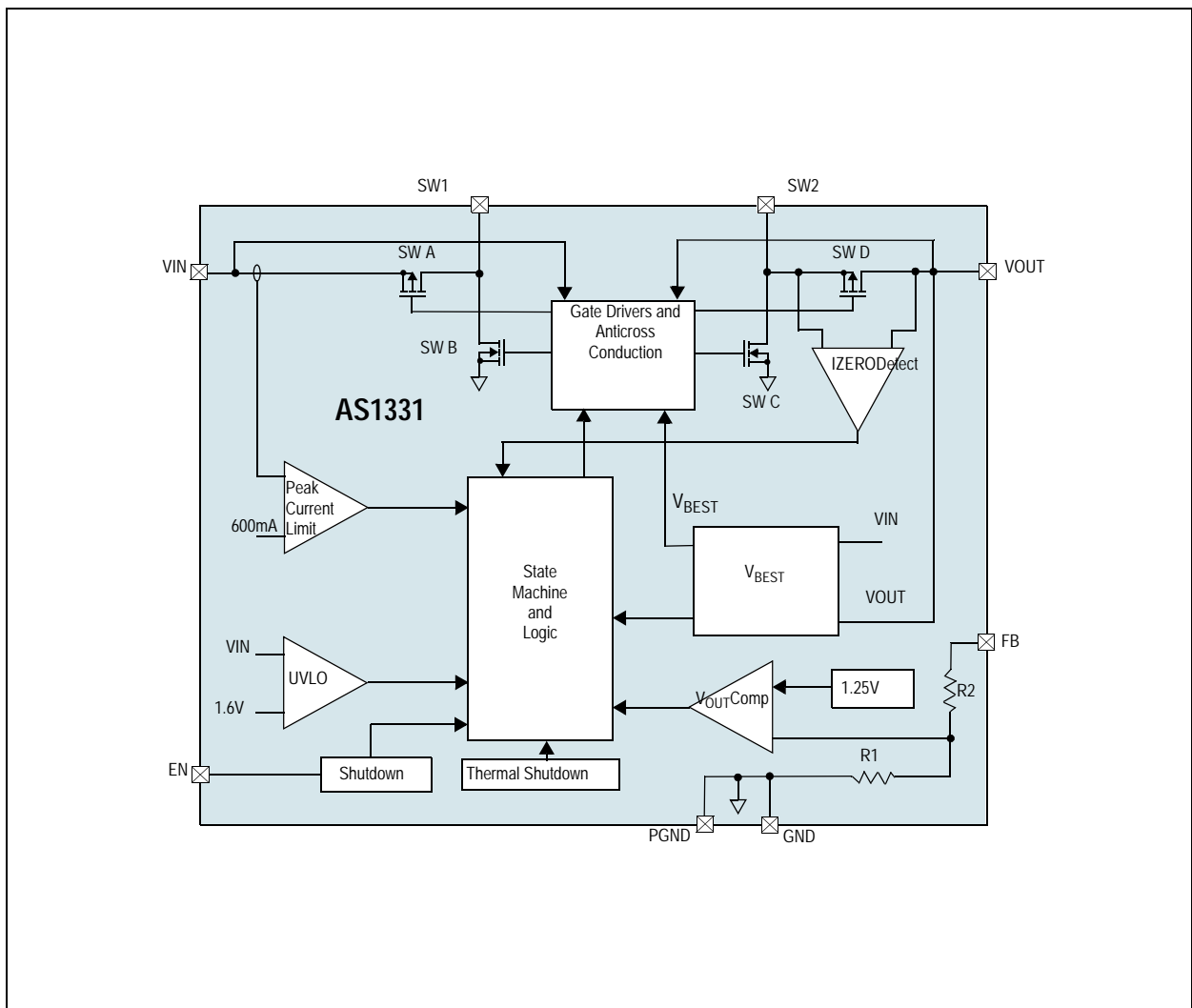


### Detailed Description

The synchronous buck-boost converter AS1331 uses a Power Save Mode control technique to reach a high efficiency over a wide dynamic range of load currents. The output voltage is monitored by a comparator with 3% accuracy. The Power Save Mode puts the device into “sleep mode” when  $V_{OUT}$  is above its programmed reference threshold. Meaning, the switching is stopped and only quiescent current is drawn from the power source. The switching is started again when  $V_{OUT}$  drops below the reference threshold and the output capacitor is charged again.

The numbers of current pulses which are necessary to load the output capacitor are set by the value of the output capacitor, the load current, and the comparator hysteresis (~1%).

Figure 27:  
Block Diagram - Fixed Output Voltage



## Modes of Operation

When  $V_{OUT}$  drops below the reference threshold, the AS1331 switches on the transistors SW A and SW C until the inductor current reaches approximately 400mA. In the next step SW A and SW D are closed and depending on the difference between  $V_{IN}$  and  $V_{OUT}$  the inductor current raises, falls or stays constant.

- $V_{IN} > V_{OUT}$ : The inductor current is going up to 600mA.
- $V_{IN} \sim V_{OUT}$ : The device stops after 2 $\mu$ s.
- $V_{IN} < V_{OUT}$ : The inductor current falls down to 0mA.

If the inductor current is not 0mA, the transistors SW B and SW D are closed to ramp down the current to zero. If  $V_{OUT}$  is still below the threshold voltage the next cycle is started. If  $I_{MAX}$  (600mA) wasn't reached in the previous cycle, SW A and SW D are closed until the inductor current is 600mA.

**Note(s):** The 4-switch-mode (SW A+SW C => SW B+SW D => SW A + SW C...) and also the buck-mode (SW A+SW D => SW B+SW D => SW A+SW D...) are never used.

## Start-Up Mode

At start-up the switch SW D is disabled and its diode is used to transfer current to the output capacitor until  $V_{OUT}$  reaches approximately 2.15V. The inductor current is controlled by an alternate algorithm during start-up.

**Note(s):** Do not apply loads >1mA until  $V_{OUT} = 2.3V$  is reached.

## Other AS1331 Features

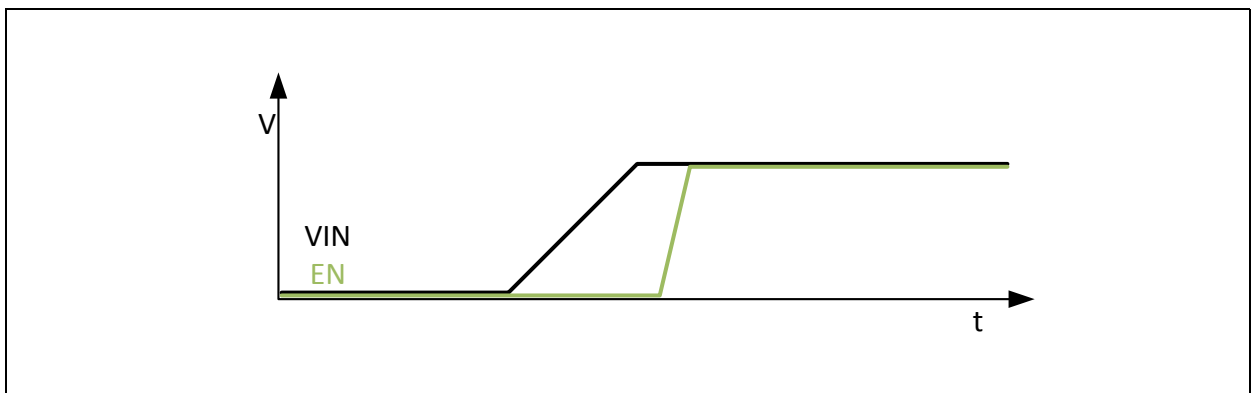
### Shutdown

The part is in shutdown mode while the voltage at pin EN is below 0.4V and is active when the voltage is higher than 1.4V. EN operation during start-up is valid only after  $V_{IN}$  is present and stable. Do not connect EN directly to  $V_{IN}$  as this does not ensure reliable start-up of the regulator.

**Note(s):** EN can be driven above  $V_{IN}$  or  $V_{OUT}$ , as long as it is limited to less than 5.5V.

In start-up enable pin must be pulled up after  $V_{IN}$  is settled. Recommended delay is 100 $\mu$ s between EN and  $V_{IN}$ .

**Figure 28:**  
AS1331 Start-Up Sequence



### Output Disconnect and Inrush Limiting

During shutdown  $V_{OUT}$  is going to 0V so that no current from the input source is running thru the device. The inrush current is also limited at turn-on mode to minimize the surge currents seen by the input supply. These features of the AS1331 are realized by opening both P-channel MOSFETs of the rectifiers, allowing a true output disconnect.

### **Power-OK and Low-Battery-Detect Functionality**

LBO goes low in startup mode as well as during normal operation if:

- The voltage at the LBI pin is below LBI threshold (1.25V). This can be used to monitor the battery voltage.
- LBI pin is connected to GND and  $V_{OUT}$  is below 92.5% of its nominal value. LBO works as a power-OK signal in this case.

The LBI pin can be connected to a resistive-divider to monitor a particular definable voltage and compare it with a 1.25V internal reference. If LBI is connected to GND an internal resistive-divider is activated and connected to the output. Therefore, the Power-OK functionality can be realized with no additional external components.

The Power-OK feature is not active during shutdown and provides a power-on-reset function that can operate down to  $V_{IN} = 1.8V$ . A capacitor to GND may be added to generate a power-on-reset delay. To obtain a logic-level output, connect a pull-up resistor from pin LBO to pin  $V_{OUT}$ . Larger values for this resistor will help to minimize current consumption; a 100k $\Omega$  resistor is perfect for most applications [Figure 30](#).

For the circuit shown in the left of [Figure 29](#), the input bias current into LBI is very low, permitting large-value resistor-divider networks while maintaining accuracy. Place the resistor-divider network as close to the device as possible. Use a defined resistor for  $R_5$  and then calculate  $R_4$  as:

$$(EQ1) \quad R_4 = R_5 \cdot \left( \frac{V_{IN}}{V_{LBI}} - 1 \right)$$

Where:

$V_{LBI}$  (the internal sense reference voltage) is 1.25V.

In case of the LBI pin is connected to GND, an internal resistor-divider network is activated and compares the output voltage with a 92.5% voltage threshold. For this particular Power-OK application, no external resistive components are necessary.

### Thermal Shutdown

To prevent the AS1331 from short-term misuse and overload conditions the chip includes a thermal overload protection. To block the normal operation mode all switches will be turned off. The device is in thermal shutdown when the junction temperature exceeds 145°C. To resume the normal operation the temperature has to drop below 135°C.

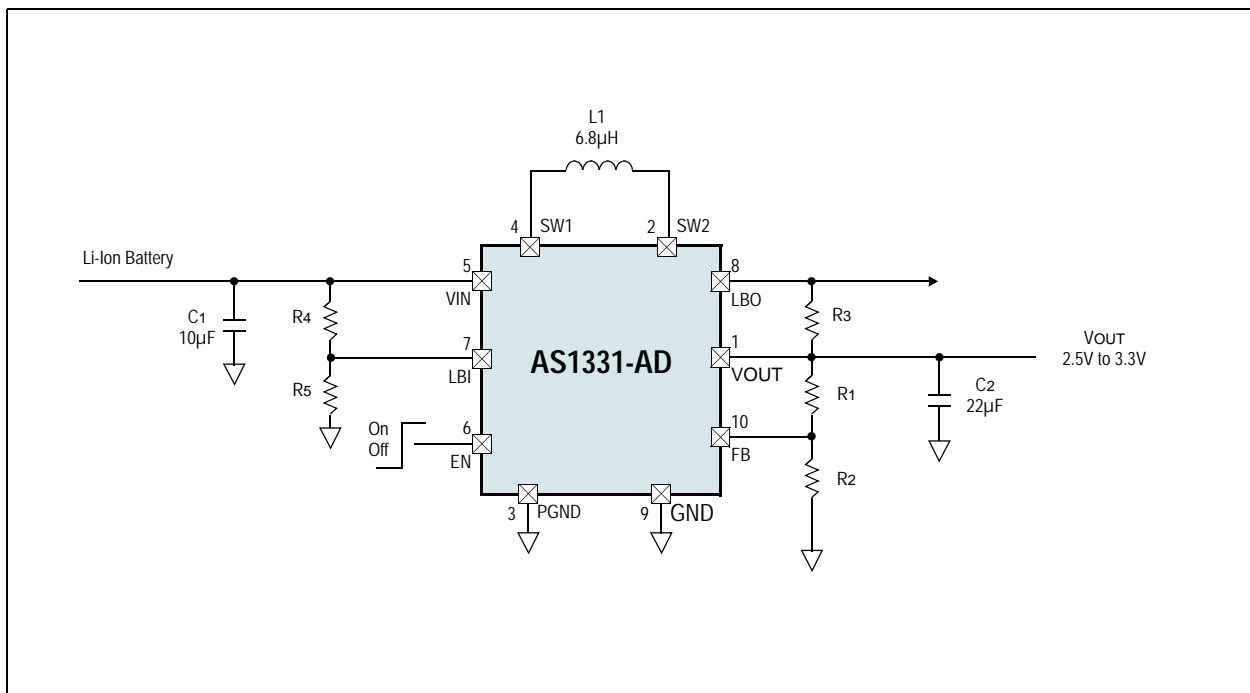
A good thermal path has to be provided to dissipate the heat generated within the package. Otherwise it's not possible to operate the AS1331 at its usable maximal power. To dissipate as much heat as possible away from the package into a copper plane with as much area as possible, it's recommended to use multiple vias in the printed circuit board. It's also recommended to solder the Exposed Pad (pin 11) to the GND plane.

**Note(s):** Continuing operation in thermal overload conditions may damage the device and is considered bad practice.

### Output Voltage Selection

The AS1331 is available in two versions [Ordering & Contact Information](#). One version can only operate at one fixed output voltage [Figure 30](#) and the other version can operate with user-adjustable output voltages from 2.5V to 3.3V by connecting a voltage divider between the pins  $V_{OUT}$  and FB [Figure 29](#).

**Figure 29:**  
Li-Ion to Adjustable Output Voltage



The output voltage can be adjusted by selecting different values for R1 and R2.

Calculate  $V_{OUT}$  by:

$$(EQ2) \quad V_{OUT} = V_{FB} \times \left(1 + \frac{R_1}{R_2}\right)$$

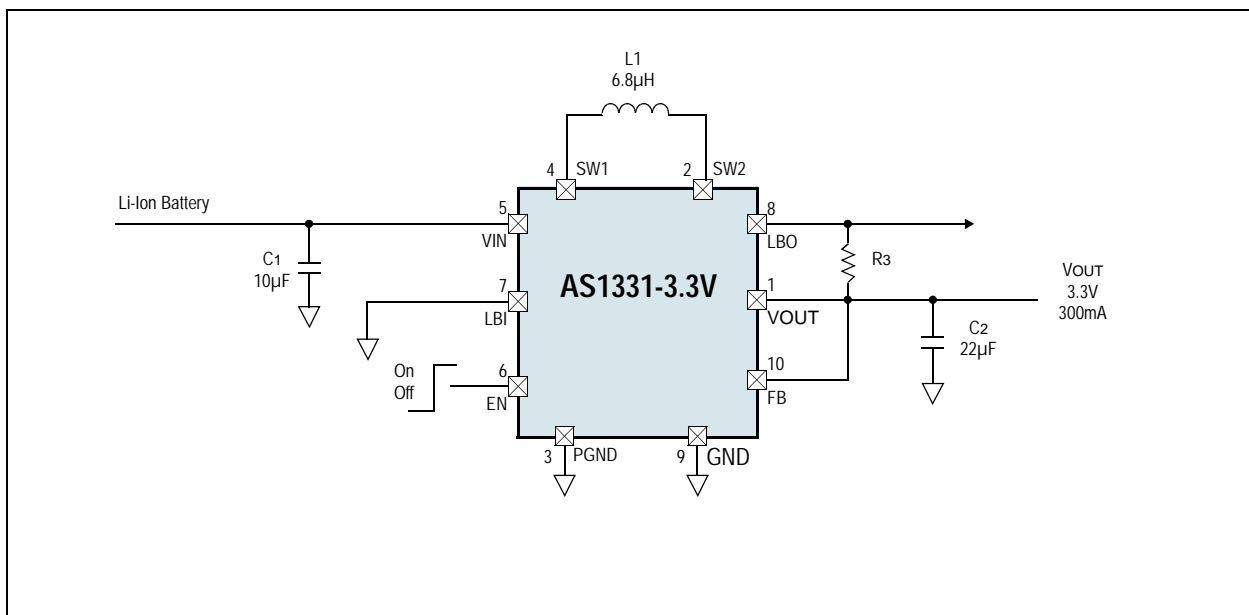
Where:

$V_{FB} = 1.25V$ ,  $V_{OUT} = 2.5V$  to  $3.3V$ ;

R2 (the predefined resistor in the resistor divider) should be  $\leq 270k\Omega$ .

R3 (the Pull-up resistor for the LBO pin) should be  $\sim 100k\Omega$ .

**Figure 30:**  
Li-Ion to 3.3V with POK - Fixed Output Voltage



## Application Information

### Component Selection

Only three power components are required to complete the design of the buck-boost converter. For the adjustable version  $V_{OUT}$  programming resistors are needed. The high operating frequency and low peak currents of the AS1331 allow the use of low value, low profile inductors and tiny external ceramic capacitors.

### Inductor Selection

For best efficiency, choose an inductor with high frequency core material, such as ferrite, to reduce core losses. The inductor should have low DCR (DC resistance) to reduce the  $I^2R$  losses, and must be able to handle the peak inductor current without saturating. A  $6.8\mu\text{H}$  inductor with a  $>600\text{mA}$  current rating and  $<400\text{m}\Omega$  DCR is recommended.

**Figure 31:**  
Recommended Inductors

Part Number	L	DCR	Current Rating	Dimensions (L/W/T)	Manufacturer
LPS3015-682M	$6.8\mu\text{H}$	$300\text{m}\Omega$	0.89A	3.0x3.0x1.5mm	Coilcraft <a href="http://www.coilcraft.com">www.coilcraft.com</a>
EPL2014-682M	$6.8\mu\text{H}$	$287\text{m}\Omega$	0.80A	2.0x2.0x1.4mm	
XPL2010-682M	$6.8\mu\text{H}$	$336\text{m}\Omega$	0.73A	2.0x1.9x1.0mm	



## Capacitor Selection

The buck-boost convertor requires two capacitors. Ceramic X5R or X7R types will minimize ESL and ESR while maintaining capacitance at rated voltage over temperature. The  $V_{IN}$  capacitor should be at least 2.2 $\mu$ F. The  $V_{OUT}$  capacitor should be between 10 $\mu$ F and 47 $\mu$ F. A larger output capacitor should be used if lower peak to peak output voltage ripple is desired. A larger output capacitor will also improve load regulation on  $V_{OUT}$ . See Figure 32 for a list of capacitors for input and output capacitor selection.

**Figure 32:**  
Recommended Input Capacitor

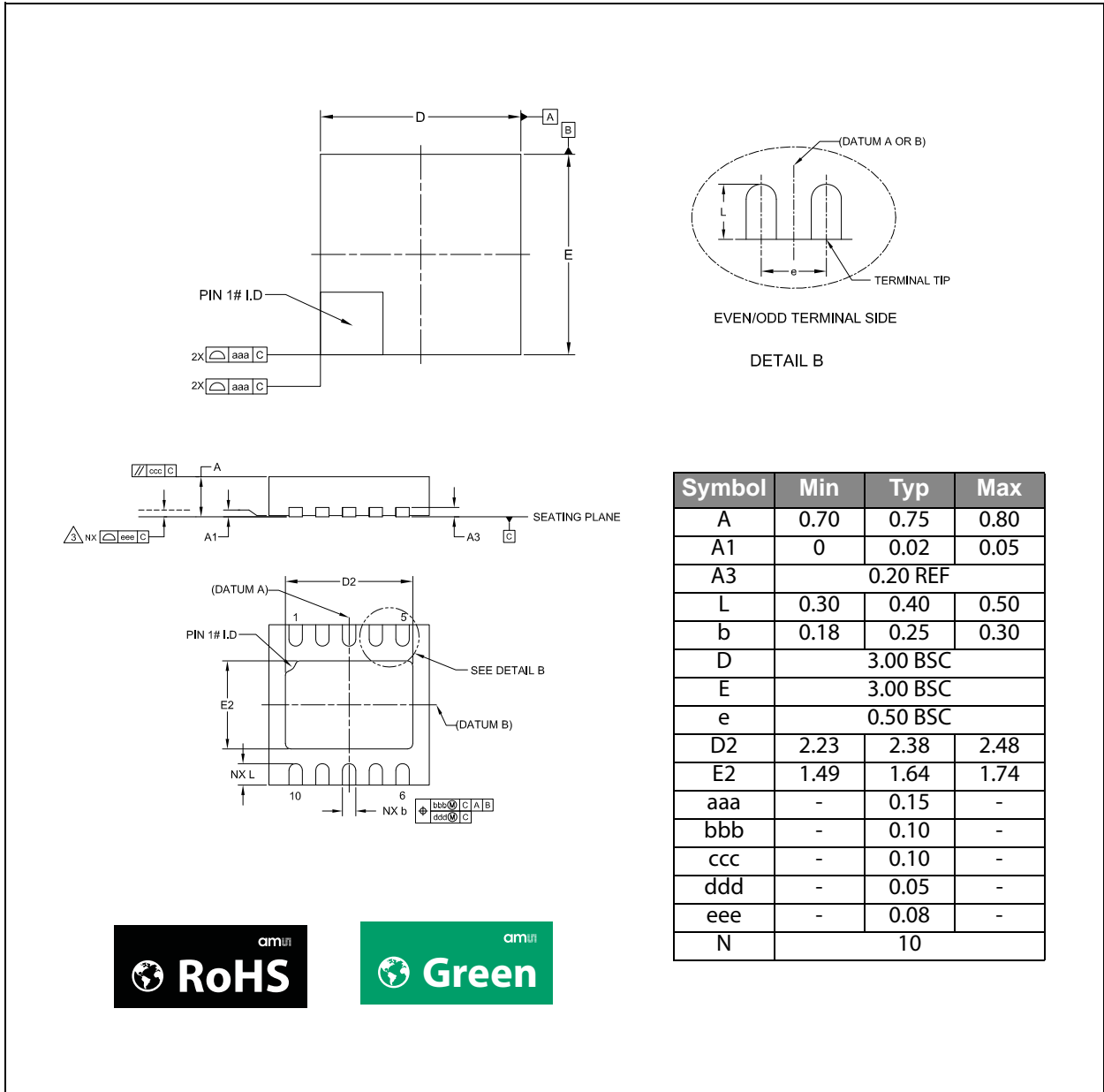
Part Number	C	TC Code	Rated Voltage	Dimensions (L/W/T)	Manufacturer
GRM188R61A225KE34	2.2 $\mu$ F	X5R	10V	0603, T=0.87mm	Murata <a href="http://www.murata.com">www.murata.com</a>
GRM188R60J475KE19	4.7 $\mu$ F	X5R	6.3V	0603, T=0.87mm	
GRM219R60J106KE19	10 $\mu$ F	X5R	6.3V	0805, T=0.95mm	

**Figure 33:**  
Recommended Output Capacitor

Part Number	C	TC Code	Rated Voltage	Dimensions (L/W/T)	Manufacturer
GRM21BR61A106KE19	10 $\mu$ F	X5R	10V	0805, T=1.35mm	Murata <a href="http://www.murata.com">www.murata.com</a>
GRM319R61A106KE19	10 $\mu$ F	X5R	10V	1206, T=0.95mm	
GRM319R61A106KE19	10 $\mu$ F	X5R	10V	1210, T=0.95mm	
GRM31CR61C226KE15	22 $\mu$ F	X5R	16V	1206, T=1.8mm	
GRM31CR60J475ME19	47 $\mu$ F	X5R	6.3V	1206, T=1.75mm	

**Package Drawings & Markings**    The device is available in a 10-pin 3x3mm TDFN package.

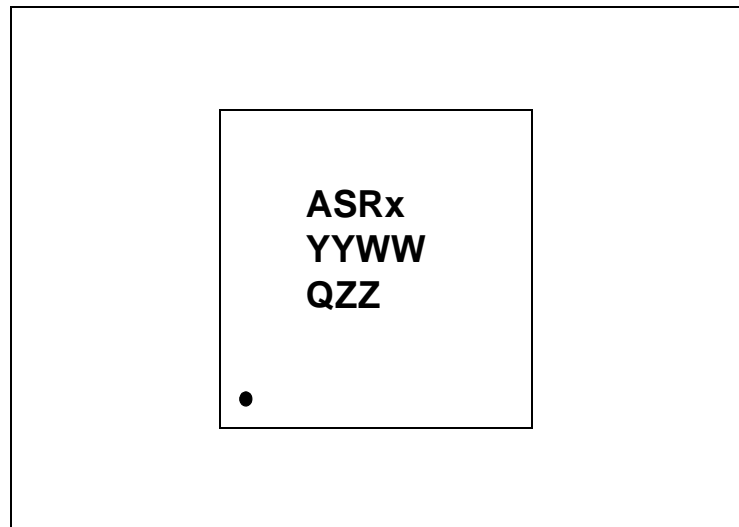
**Figure 34:**  
10-Pin 3x3mm TDFN Package Diagram



**Note(s):**

1. Dimensioning and tolerancing conform to ASME Y14.5M-1994.
2. All dimensions are in millimeters (angles are in degrees).
3. Coplanarity applies to the exposed heat slug as well as the terminal.
4. Radius on terminal is optional.
5. N is the total number of terminals.

**Figure 35:**  
Package Marking



**Note(s):**

1. Where x can be P, U, T, R.

**Figure 36:**  
Package Code

YY	WW	Q	ZZ
Manufacturing year	Manufacturing week	Plant's identifier	Letters of free choice

## Ordering & Contact Information

The device is available as the standard products shown in [Figure 37](#).

**Figure 37:**  
Ordering Information

Ordering Code	Package	Marking	Output	Delivery Form	Delivery Quantity
AS1331-BTDT-AD	10-pin 3x3mm TDFN	ASRP	Adjustable	Tape & Reel	1000 pcs/reel
AS1331-BTDT-25 <sup>(1)</sup>	10-pin 3x3mm TDFN	ASRR	2.5V	Tape & Reel	1000 pcs/reel
AS1331-BTDT-30 <sup>(1)</sup>	10-pin 3x3mm TDFN	ASRT	3.0V	Tape & Reel	1000 pcs/reel
AS1331-BTDT-33	10-pin 3x3mm TDFN	ASRU	3.3V	Tape & Reel	1000 pcs/reel

**Note(s):**

1. On request.

Buy our products or get free samples online at:  
[www.ams.com/ICdirect](http://www.ams.com/ICdirect)

Technical Support is available at:  
[www.ams.com/Technical-Support](http://www.ams.com/Technical-Support)

Provide feedback about this document at:  
[www.ams.com/Document-Feedback](http://www.ams.com/Document-Feedback)

For further information and requests, e-mail us at:  
[ams\\_sales@ams.com](mailto:ams_sales@ams.com)

For sales offices, distributors and representatives, please visit:  
[www.ams.com/contact](http://www.ams.com/contact)

**Headquarters**

ams AG  
Tobelbaderstrasse 30  
8141 Unterpremstaetten  
Austria, Europe

Tel: +43 (0) 3136 500 0

Website: [www.ams.com](http://www.ams.com)

## RoHS Compliant & ams Green Statement

**RoHS:** The term RoHS compliant means that ams AG products fully comply with current RoHS directives. Our semiconductor products do not contain any chemicals for all 6 substance categories, including the requirement that lead not exceed 0.1% by weight in homogeneous materials. Where designed to be soldered at high temperatures, RoHS compliant products are suitable for use in specified lead-free processes.

**ams Green (RoHS compliant and no Sb/Br):** ams Green defines that in addition to RoHS compliance, our products are free of Bromine (Br) and Antimony (Sb) based flame retardants (Br or Sb do not exceed 0.1% by weight in homogeneous material).

**Important Information:** The information provided in this statement represents ams AG knowledge and belief as of the date that it is provided. ams AG bases its knowledge and belief on information provided by third parties, and makes no representation or warranty as to the accuracy of such information. Efforts are underway to better integrate information from third parties. ams AG has taken and continues to take reasonable steps to provide representative and accurate information but may not have conducted destructive testing or chemical analysis on incoming materials and chemicals. ams AG and ams AG suppliers consider certain information to be proprietary, and thus CAS numbers and other limited information may not be available for release.

## Copyrights & Disclaimer

Copyright ams AG, Tobelbader Strasse 30, 8141 Unterpremstaetten, Austria-Europe. Trademarks Registered. All rights reserved. The material herein may not be reproduced, adapted, merged, translated, stored, or used without the prior written consent of the copyright owner.

Devices sold by ams AG are covered by the warranty and patent indemnification provisions appearing in its General Terms of Trade. ams AG makes no warranty, express, statutory, implied, or by description regarding the information set forth herein. ams AG reserves the right to change specifications and prices at any time and without notice. Therefore, prior to designing this product into a system, it is necessary to check with ams AG for current information. This product is intended for use in commercial applications. Applications requiring extended temperature range, unusual environmental requirements, or high reliability applications, such as military, medical life-support or life-sustaining equipment are specifically not recommended without additional processing by ams AG for each application. This product is provided by ams AG "AS IS" and any express or implied warranties, including, but not limited to the implied warranties of merchantability and fitness for a particular purpose are disclaimed.

ams AG shall not be liable to recipient or any third party for any damages, including but not limited to personal injury, property damage, loss of profits, loss of use, interruption of business or indirect, special, incidental or consequential damages, of any kind, in connection with or arising out of the furnishing, performance or use of the technical data herein. No obligation or liability to recipient or any third party shall arise or flow out of ams AG rendering of technical or other services.

## Document Status

Document Status	Product Status	Definition
Product Preview	Pre-Development	Information in this datasheet is based on product ideas in the planning phase of development. All specifications are design goals without any warranty and are subject to change without notice
Preliminary Datasheet	Pre-Production	Information in this datasheet is based on products in the design, validation or qualification phase of development. The performance and parameters shown in this document are preliminary without any warranty and are subject to change without notice
Datasheet	Production	Information in this datasheet is based on products in ramp-up to full production or full production which conform to specifications in accordance with the terms of ams AG standard warranty as given in the General Terms of Trade
Datasheet (discontinued)	Discontinued	Information in this datasheet is based on products which conform to specifications in accordance with the terms of ams AG standard warranty as given in the General Terms of Trade, but these products have been superseded and should not be used for new designs

## Revision Information

Changes from 1.4 (2010) to current revision 1-06 (2015-Dec-07)	Page
<b>1.4 (2010) to 1-05 (2015-Dec-02)</b>	
Content was updated to the latest <b>ams</b> design	
Added benefits to Key Features	1
Updated Other AS1331 Features section	20
Updated Package Drawings & Markings section	26
<b>1-05 (2015-Dec-02) to 1-06 (2015-Dec-07)</b>	
Updated Figure 34	26

**Note(s):**

1. Page and figure numbers for the previous version may differ from page and figure numbers in the current revision.
2. Correction of typographical errors is not explicitly mentioned.



## Content Guide

<b>1</b>	<b>General Description</b>
1	Key Benefits & Features
2	Applications
2	Block Diagram
<b>3</b>	<b>Pin Assignment</b>
<b>5</b>	<b>Absolute Maximum Ratings</b>
<b>6</b>	<b>Electrical Characteristics</b>
<b>8</b>	<b>Typical Operating Characteristics</b>
<b>18</b>	<b>Detailed Description</b>
19	Modes of Operation
19	Start-Up Mode
20	Other AS1331 Features
21	Power-OK and Low-Battery-Detect Functionality
22	Thermal Shutdown
22	Output Voltage Selection
<b>24</b>	<b>Application Information</b>
24	Component Selection
24	Inductor Selection
25	Capacitor Selection
<b>26</b>	<b>Package Drawings &amp; Markings</b>
<b>28</b>	<b>Ordering &amp; Contact Information</b>
<b>29</b>	<b>RoHS Compliant &amp; ams Green Statement</b>
<b>30</b>	<b>Copyrights &amp; Disclaimer</b>
<b>31</b>	<b>Document Status</b>
<b>32</b>	<b>Revision Information</b>

## X-ON Electronics

Largest Supplier of Electrical and Electronic Components

*Click to view similar products for [Switching Voltage Regulators](#) category:*

*Click to view products by [ams](#) manufacturer:*

Other Similar products are found below :

[FAN53610AUC33X](#) [FAN53611AUC123X](#) [FAN48610BUC33X](#) [FAN48610BUC45X](#) [FAN48617UC50X](#) [R3](#) [430464BB](#) [KE177614](#)  
[FAN53611AUC12X](#) [MAX809TTR](#) [NCV891234MW50R2G](#) [NCP81103MNTXG](#) [NCP81203PMNTXG](#) [NCP81208MNTXG](#)  
[NCP81109GMNTXG](#) [SCY1751FCCT1G](#) [NCP81109JMNTXG](#) [AP3409ADNTR-G1](#) [NCP81241MNTXG](#) [LTM8064IY](#) [LT8315EFE#TRPBF](#)  
[LTM4664EY#PBF](#) [LTM4668AIY#PBF](#) [NCV1077CSTBT3G](#) [XCL207A123CR-G](#) [MPM54304GMN-0002](#) [MPM54304GMN-0004](#)  
[MPM54304GMN-0003](#) [AP62300Z6-7](#) [MP8757GL-P](#) [MIC23356YFT-TR](#) [LD8116CGL](#) [HG2269M/TR](#) [OB2269](#) [XD3526](#) [U6215A](#) [U6215B](#)  
[U6620S](#) [LTC3412IFE](#) [LT1425IS](#) [MAX25203BATJA/VY+](#) [MAX77874CEWM+](#) [XC9236D08CER-G](#) [MP3416GJ-P](#) [MP5461GC-Z](#)  
[MPQ4415AGQB-Z](#) [MPQ4590GS-Z](#) [MAX38640BENT18+T](#) [MAX77511AEWB+](#) [MAX20406AFOD/VY+](#)