

# AS1374

## Dual 200mA, Low-Noise, High-PSRR, Low Dropout Regulator

### General Description

The AS1374 is a low-noise, low-dropout linear regulator with two separated outputs. Designed to deliver 200mA continuous output current at each output pin, the LDOs can achieve a low 120mV dropout for 200mA load current and are designed and optimized to work with low-cost, small-capacitance ceramic capacitors.

An integrated P-channel MOSFET pass transistor allows the devices to maintain extremely low quiescent current (30µA).

The AS1374 uses an advanced architecture to achieve ultra-low output voltage noise of 20µV<sub>RMS</sub> and a power-supply rejection-ratio of better than 85dB (@ 1kHz).

Two active-High enable pins allows to switch on or off each output independently from each other.

The AS1374 requires only 1µF output capacitor for stability at any load.

The device is available in a 6-bump WLCSP package.

*Ordering Information and Content Guide appear at end of datasheet.*

### Key Benefits & Features

The benefits and features of AS1374, Dual 200mA, Low-Noise, High-PSRR, Low Dropout Regulator are listed below:

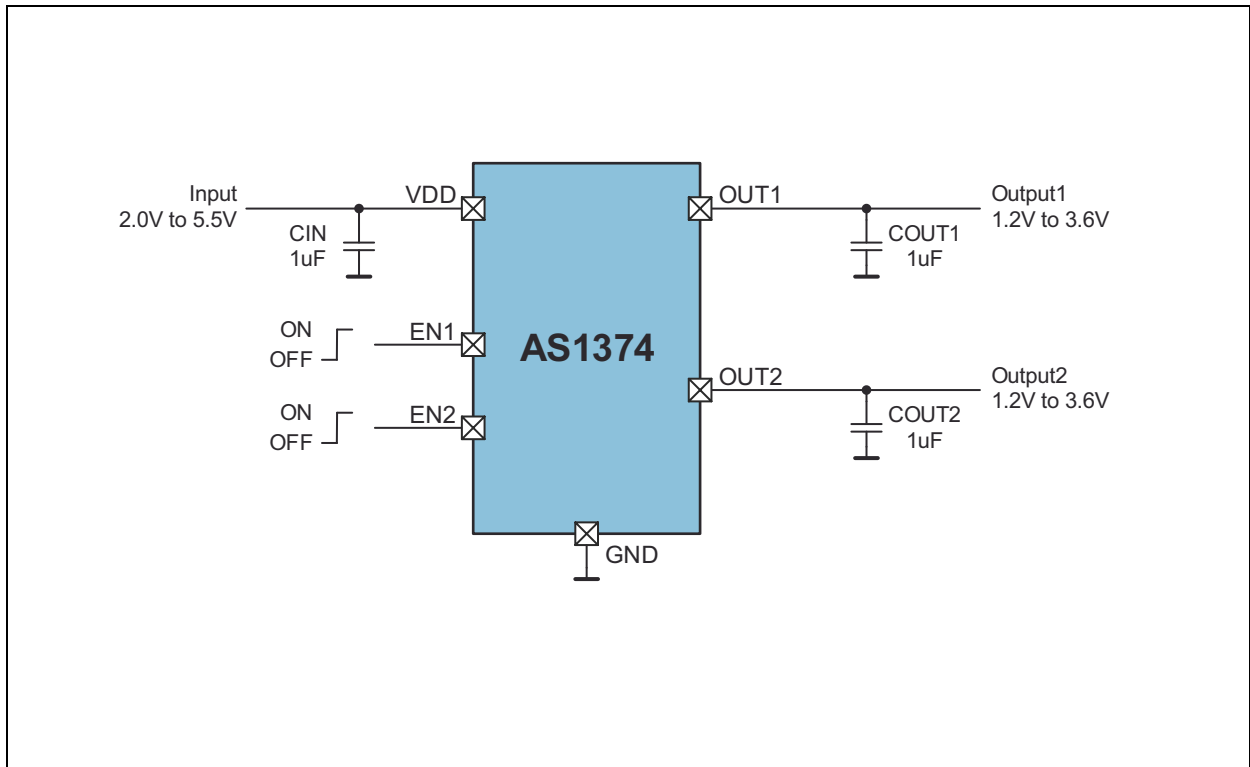
**Figure 1:**  
Added Value of Using AS1374

Benefits	Features
<ul style="list-style-type: none"> <li>Ideal for battery-powered applications</li> </ul>	<ul style="list-style-type: none"> <li>Input voltage from 2.0V to 5.5V</li> <li>Low quiescent current of 30µA</li> <li>Low dropout of 120mV at 200mA load</li> </ul>
<ul style="list-style-type: none"> <li>Supports a variety of end applications</li> </ul>	<ul style="list-style-type: none"> <li>Output voltage from 1.2V to 3.6V</li> <li>Guaranteed output current of 200mA</li> <li>Pull-down option in shutdown (factory set)</li> </ul>
<ul style="list-style-type: none"> <li>Overtemperature and overcurrent protection and shutdown</li> </ul>	<ul style="list-style-type: none"> <li>Integrated temperature and output power monitoring</li> </ul>
<ul style="list-style-type: none"> <li>Cost-effective, small PCB area needed</li> </ul>	<ul style="list-style-type: none"> <li>Small external components needed</li> <li>Small 6-balls WLCSP package</li> </ul>

## Applications

The devices are ideal for mobile phones, wireless phones, PDAs, handheld computers, mobile phone base stations, Bluetooth portable radios and accessories, wireless LANs, digital cameras, personal audio devices, and any other portable, battery-powered application.

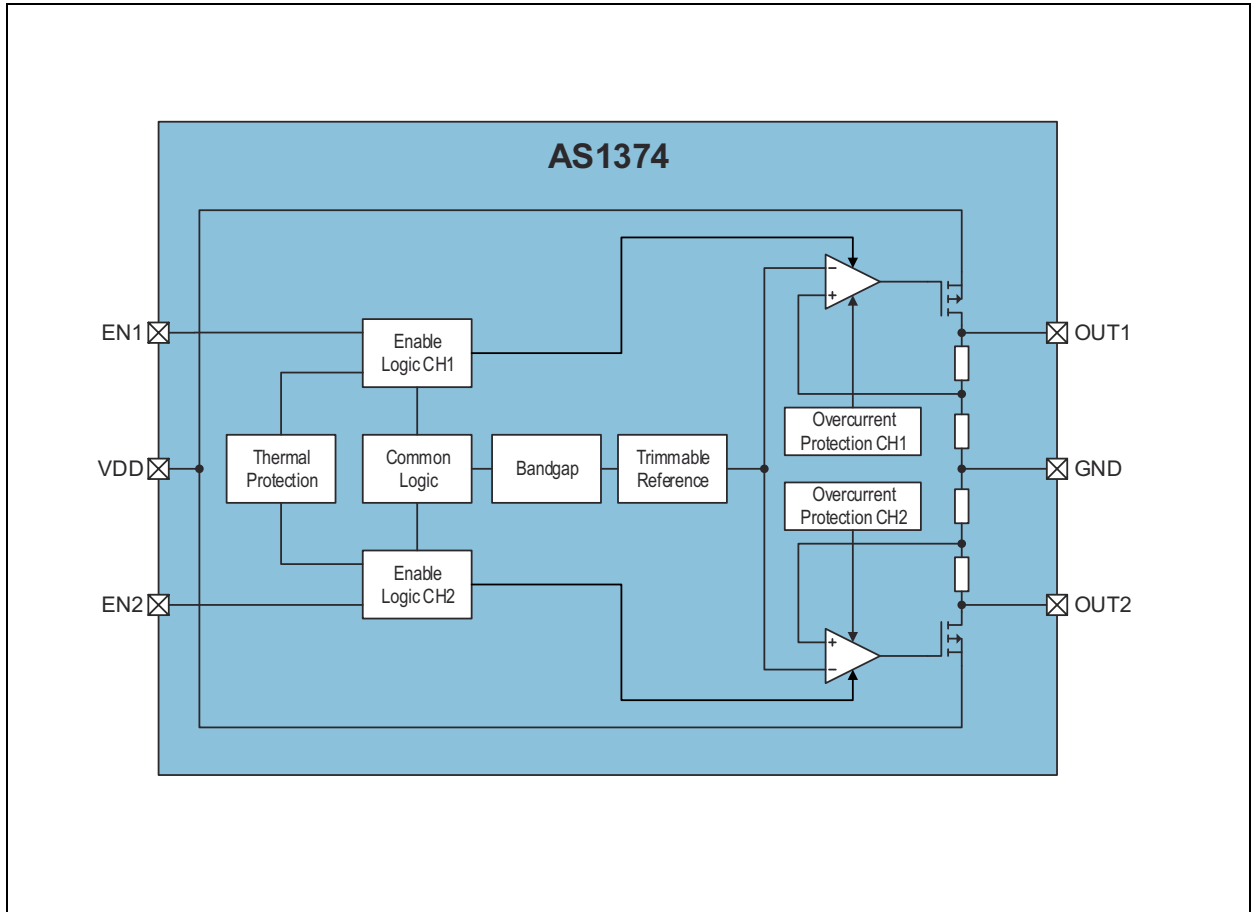
**Figure 2:**  
**A1374 Typical Application Circuit**



### Block Diagram

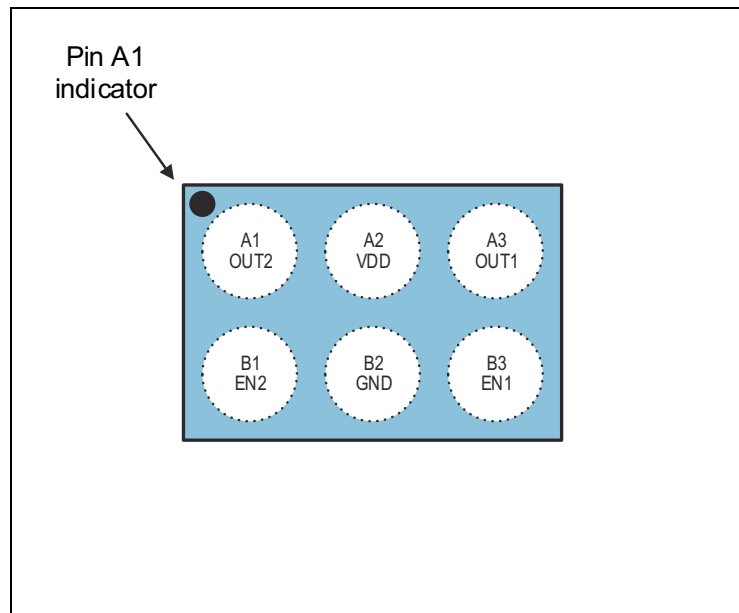
The functional blocks of this device are shown below:

**Figure 3:**  
**A1374 Block Diagram**



## Pin Assignment

**Figure 4:**  
Pin Diagram



**Figure 5:**  
Pin Descriptions

Pin Number	Pin Name	Description
A1	OUT 2	Regulated Output Voltage 2. Bypass this pin with a capacitor to GND. See <a href="#">Application Information</a> for capacitor selection.
A2	VDD	Input Supply
A3	OUT 1	Regulated Output Voltage 1. Bypass this pin with a capacitor to GND. See <a href="#">Application Information</a> for capacitor selection.
B1	EN 2	Enable 2. Pull this pin to logic low to disable Regulated Output 2 voltage.
B2	GND	Ground
B3	EN 1	Enable 1. Pull this pin to logic low to disable Regulated Output 1 voltage.

## Absolute Maximum Ratings

Stresses beyond those listed in [Absolute Maximum Ratings](#) may cause permanent damage to the device. These are stress ratings only, and functional operation of the device at these or any other conditions beyond those indicated in [Electrical Characteristics](#) is not implied. Exposure to absolute maximum rating conditions for extended periods may affect device reliability.

**Figure 6:**  
Absolute Maximum Ratings

Parameter	Min	Max	Units	Comments
<b>Electrical Parameters</b>				
VDD to GND	-0.3	7	V	
All other pins to GND	-0.3	VDD + 0.3	V	
Output short-circuit duration		Infinite		
Input current (latch-up immunity)	-100	100	mA	JEDEC 78
<b>Electrostatic Discharge</b>				
Electrostatic discharge HBM		±2	kV	MIL 883 E method 3015
<b>Temperature Ranges and Storage Conditions</b>				
Thermal resistance $\Theta_{JA}$		201.7	°C/W	Junction-to-ambient thermal resistance is very dependent on application and board-layout. In situations where high maximum power dissipation exists, special attention must be paid to thermal dissipation during board design.
Junction temperature		125	°C	
Storage temperature range	-55	150	°C	
Package body temperature		260	°C	The reflow peak soldering temperature (body temperature) specified is in accordance with <i>IPC/JEDEC J-STD-020 "Moisture/Reflow Sensitivity Classification for Non-Hermetic Solid State Surface Mount Devices"</i> .
Relative humidity non-condensing	5	85	%	
Moisture sensitivity level		1		Maximum floor life time of Unlimited

## Electrical Characteristics

$V_{IN} = V_{OUT} + 0.5V$ ,  $V_{OUT} = 2.85V$ ,  $C_{IN} = C_{OUT} = 1\mu F$ , Typical values are at  $T_{AMB} = 25^{\circ}C$  (unless otherwise specified). All limits are guaranteed. The parameters with min and max values are guaranteed with production tests or SQC (Statistical Quality Control) methods.

**Figure 7:**  
**Electrical Characteristics**

Symbol	Parameter	Condition	Min	Typ	Max	Unit
$T_{AMB}$	Operating Temperature Range		-40		85	$^{\circ}C$
$V_{IN}$	Input Range		2		5.5	V
$\Delta V_{OUT}$	Output Voltage Accuracy	$I_{OUT} = 1mA$ , $T_{AMB} = 25^{\circ}C$	-1		+1	%
		$I_{OUT} = 100\mu A$ to $200mA$ , $T_{AMB} = 25^{\circ}C$	-1.5		+1.5	
		$I_{OUT} = 100\mu A$ to $200mA$	-2.5		+2.5	
$I_{OUT}$	Maximum Output Current	Each channel	200			mA
$I_{GND}$	Ground Current	One channel on, $I_{OUT} = 50\mu A$		25	50	$\mu A$
		One channel on, $I_{OUT} = 200mA$		30	55	$\mu A$
$I_{LIMIT}$	Current Limit	OUT = short	210	300	400	mA
	Dropout Voltage <sup>(1)</sup>	$2V \leq V_{OUT} < 2.5V$ , $I_{OUT} = 100mA$		80	150	mV
IQ	Quiescent Current	Both channels on, $I_{OUT} = 0.05mA$		30	90	$\mu A$
		Both channels ON, $V_{IN} = V_{OUTNOM} - 0.1V$ , $I_{OUT} = 0mA$		50		
$V_{LNR}$	Line Regulation	$V_{IN} = (V_{OUT} + 0.5V)$ to $5.5V$ , $I_{OUT} = 1mA$		0.02		%/V
$V_{LDR}$	Load Regulation	$I_{OUT} = 1$ to $200mA$		0.00 05		%/mA
$I_{SHDN}$	Shutdown Current	OUT 1 and OUT 2 disable		0.01	2	$\mu A$
PSRR	Ripple Rejection	$f = 1kHz$ , $I_{OUT} = 10mA$		85		dB
		$f = 10kHz$ , $I_{OUT} = 10mA$		65		
		$f = 100kHz$ , $I_{OUT} = 10mA$		50		

Symbol	Parameter	Condition	Min	Typ	Max	Unit
	Output Noise Voltage (RMS)	f = 100Hz to 100kHz, I <sub>LOAD</sub> = 20mA		20		μV
<b>Enable</b>						
	Enable Input Bias Current			0.01		μA
	Enable Exit Delay <sup>(2)</sup>	Both channels initially OFF		150		μs
		One channel initially OFF		200		
	Enable Logic Low Level				0.4	V
	Enable Logic High Level		1.4			V
<b>Thermal Protection</b>						
T <sub>SHDN</sub>	Thermal Shutdown Temperature			160		°C
ΔT <sub>SHDN</sub>	Thermal Shutdown Hysteresis			15		°C
C <sub>OUT</sub>	Output Capacitor	Load Capacitor Range	0.47		10	μF
		Maximum ESR Load			500	mΩ

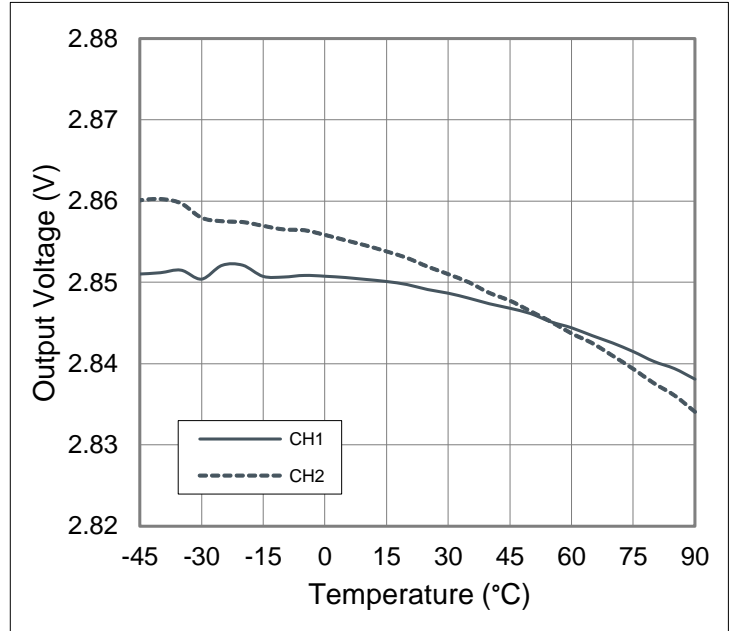
**Note(s):**

- Dropout is defined as V<sub>IN</sub> - V<sub>OUT</sub> when V<sub>OUT</sub> is 100mV below the value of V<sub>OUT</sub> for V<sub>IN</sub> = V<sub>OUT</sub> + 0.5V.
- Time needed for V<sub>OUT</sub> to reach 90% of final value.

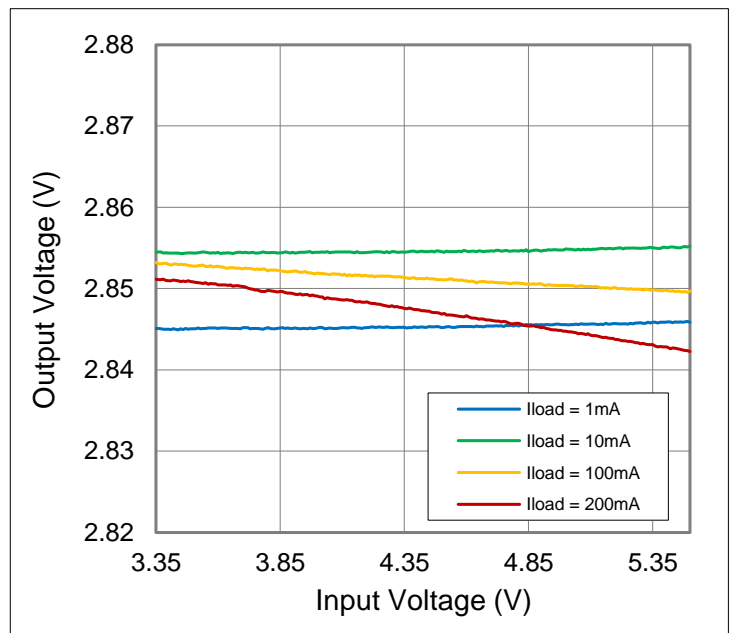
**Typical Operating Characteristics**

$V_{IN} = V_{OUT} + 0.5V$ ,  $V_{OUT} = 2.85V$ ,  $C_{IN} = C_{OUT} = 1\mu F$ ,  
 $T_{AMB} = 25^{\circ}C$  (unless otherwise specified).

**Figure 8:**  
**Output Voltage vs. Temperature**

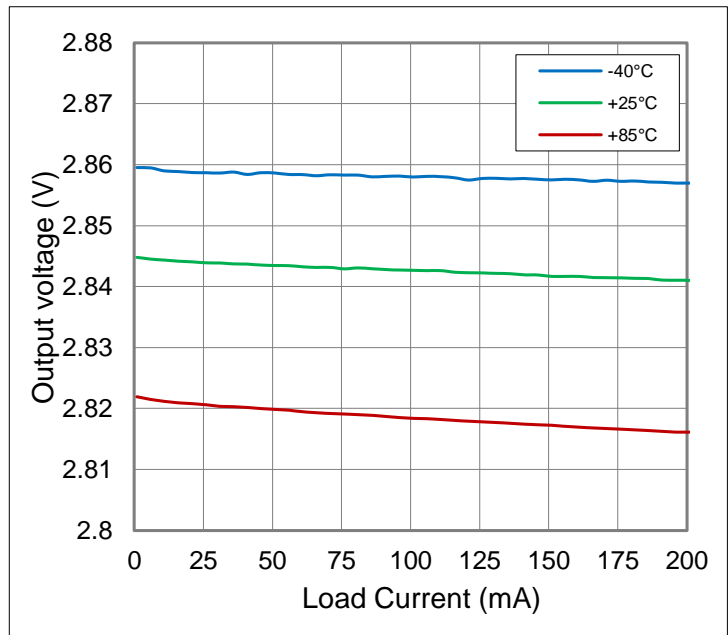


**Figure 9:**  
**Output Voltage vs. Input Voltage**

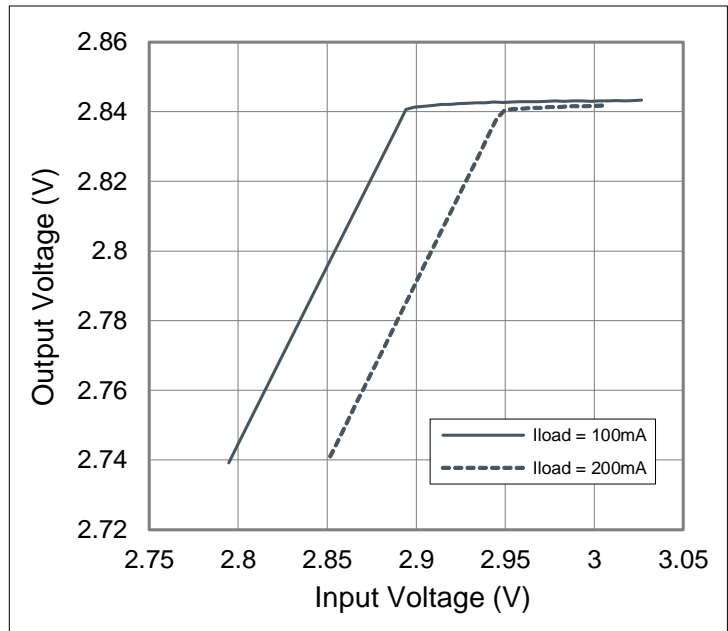




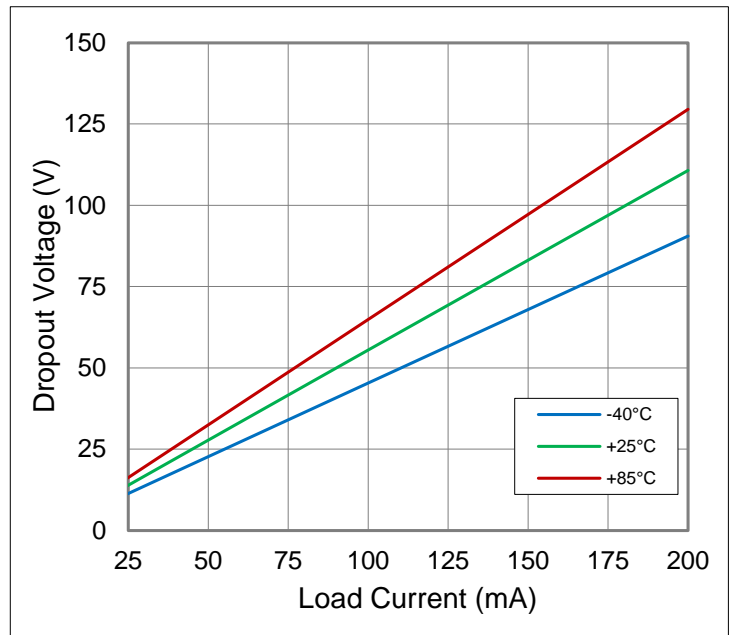
**Figure 10:**  
Output Voltage vs. Load Current



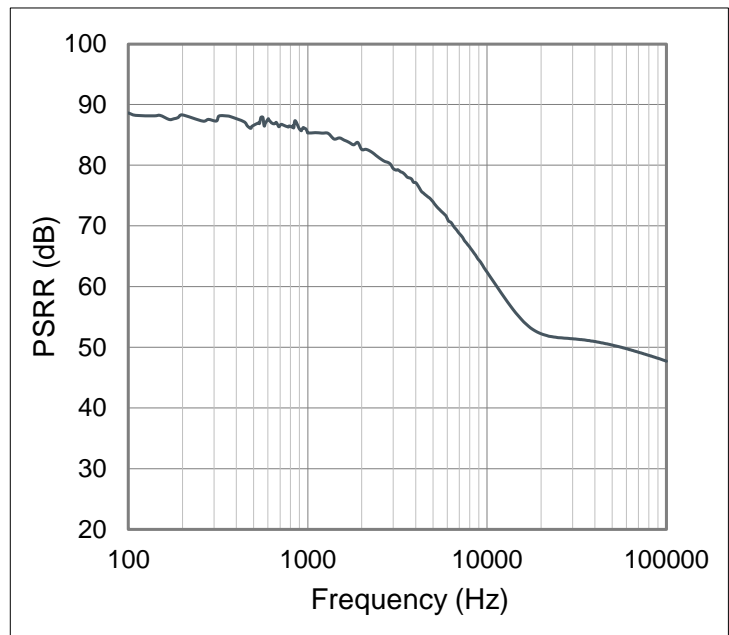
**Figure 11:**  
Output Voltage vs. Input Voltage - Dropout



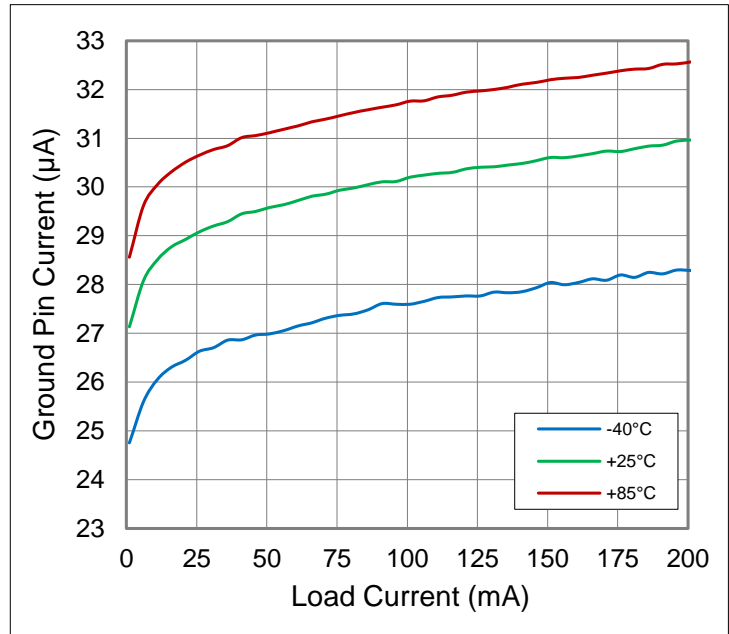
**Figure 12:**  
Dropout Voltage vs. Load Current



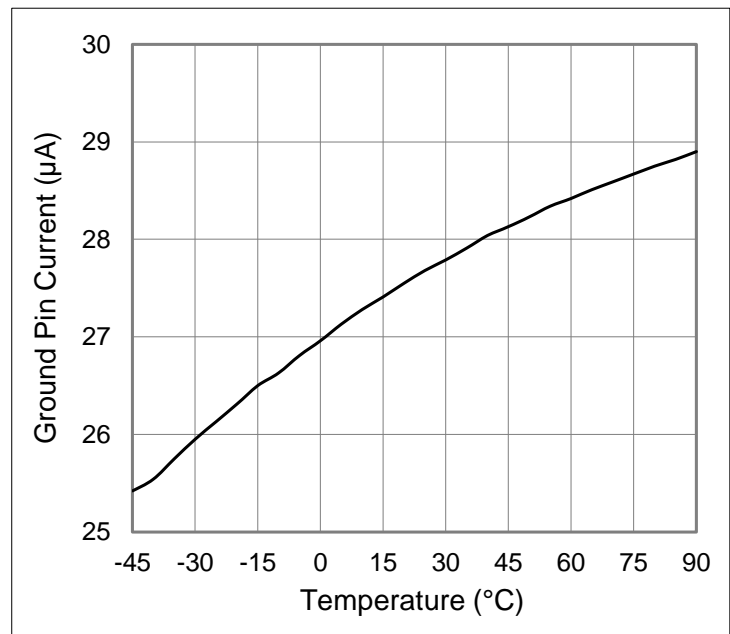
**Figure 13:**  
PSRR vs. Frequency



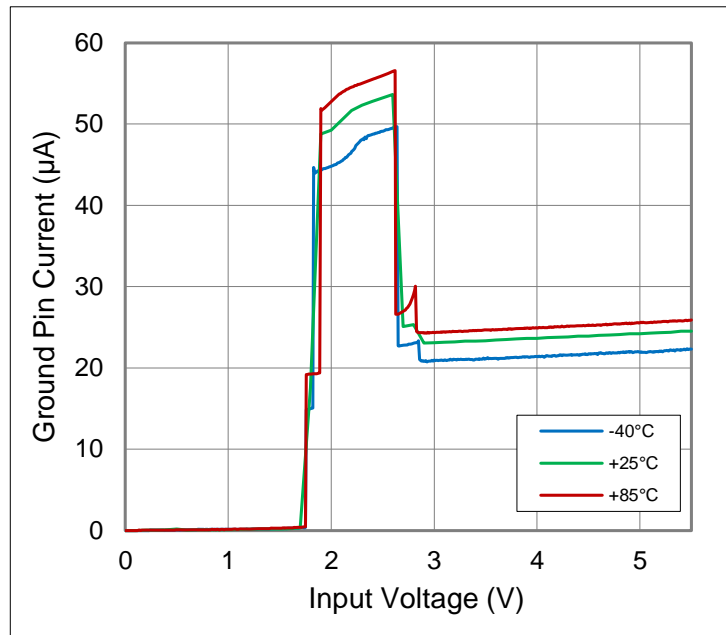
**Figure 14:**  
Ground Pin Current vs. Load Current



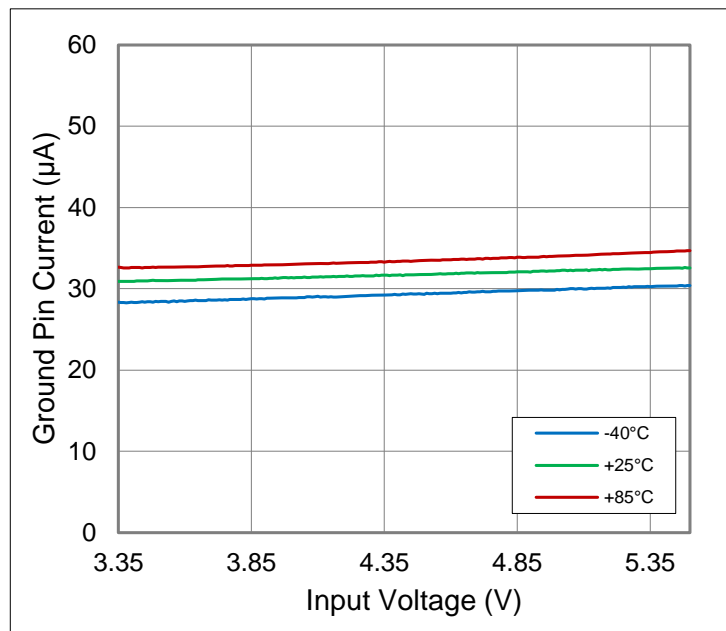
**Figure 15:**  
Ground Pin Current vs. Temperature



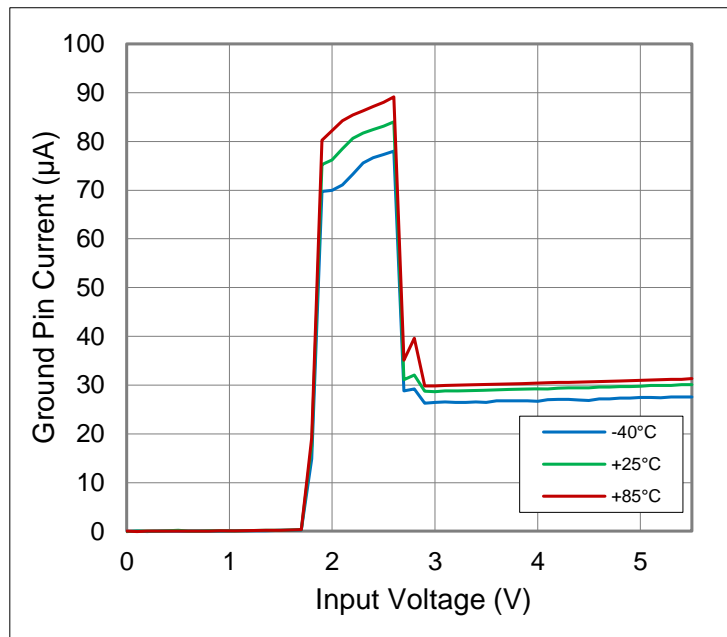
**Figure 16:**  
**Ground Pin Current vs. Input Voltage; One Channel On, No Load**



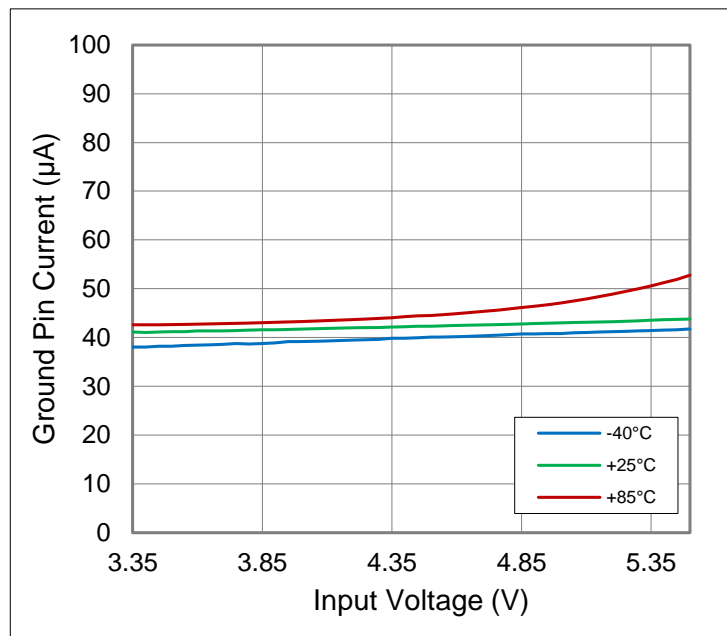
**Figure 17:**  
**Ground Pin Current vs. Input Voltage; One Channel On,  $I_{LOAD} = 200mA$**



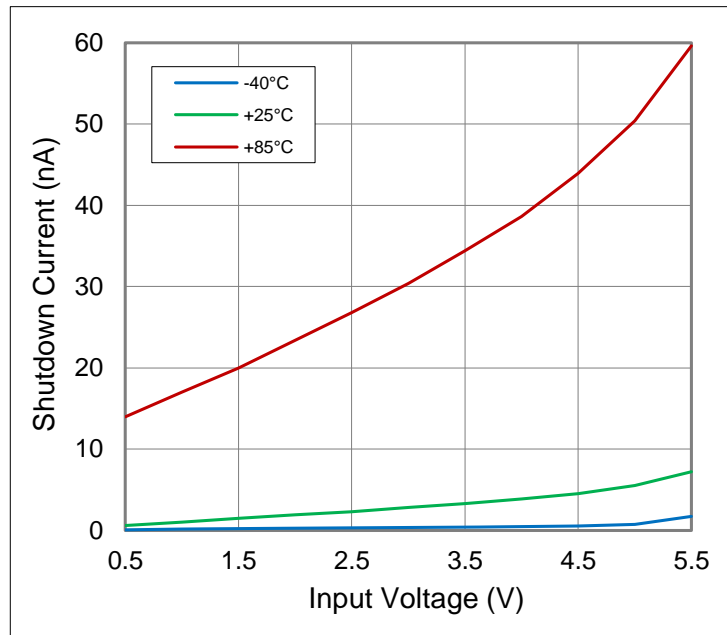
**Figure 18:**  
**Ground Pin Current vs. Input Voltage; Both Channels on, No Load**



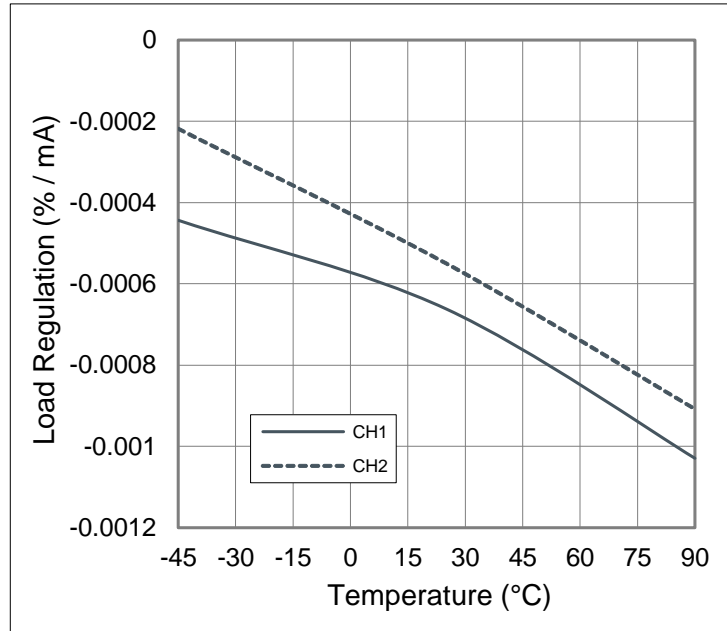
**Figure 19:**  
**Ground Pin Current vs. Input Voltage; Both Channels On,  $I_{LOAD} = 200mA$**



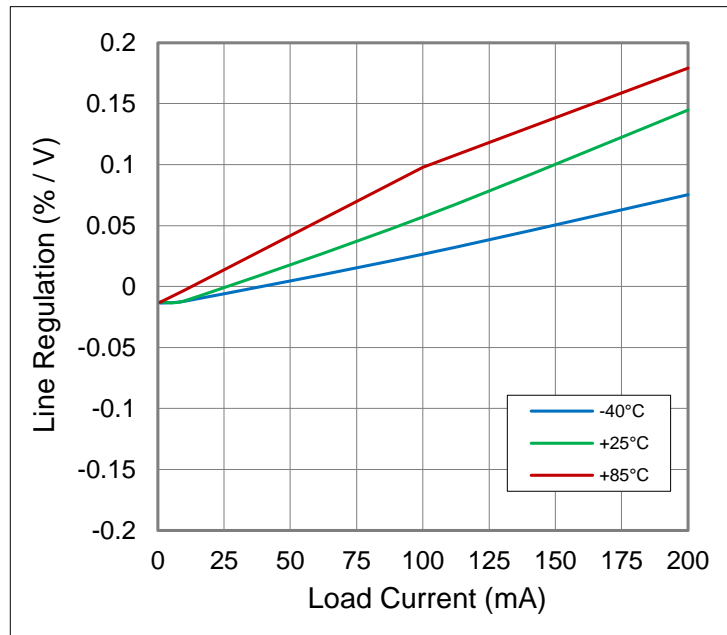
**Figure 20:**  
Shutdown Current vs. Input Voltage



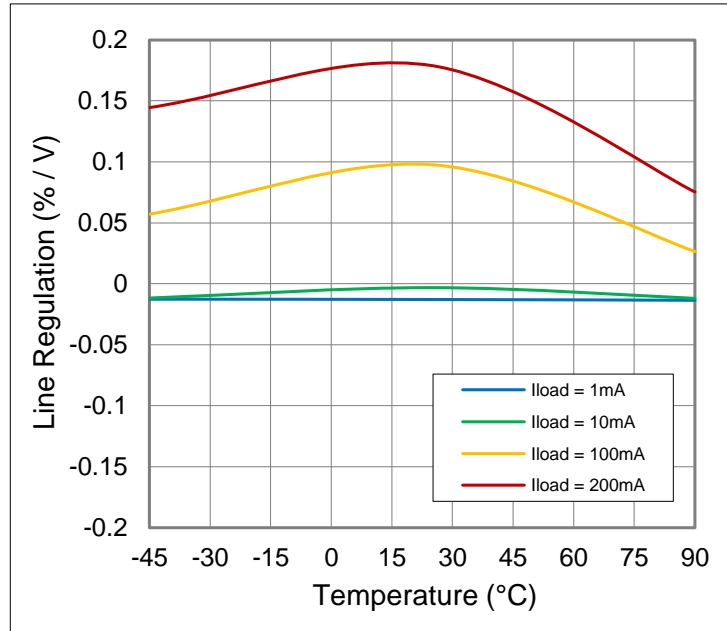
**Figure 21:**  
Load Regulation vs. Temperature



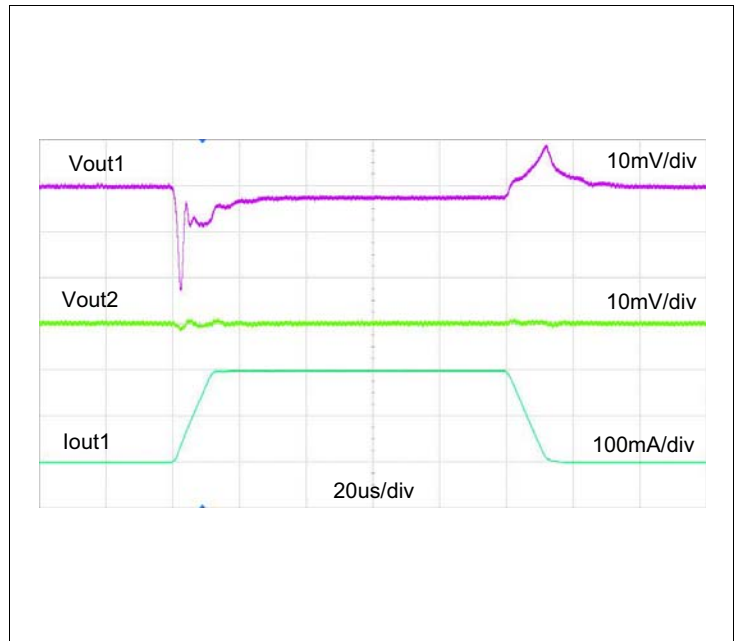
**Figure 22:**  
Line Regulation vs. Load Current



**Figure 23:**  
Line Regulation vs. Temperature



**Figure 24:**  
**Load Transient Response, Crosstalk, Between CH1 and CH2,**  
 $I_{OUT} = 200\text{mA}$

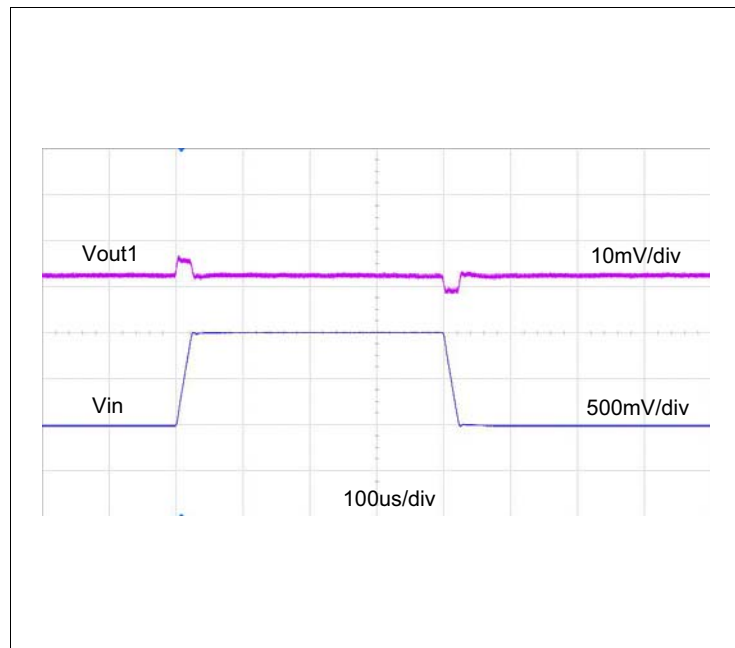


**Figure 25:**  
**Load Transient Response Near Dropout,**  
 $I_{OUT} = 200\text{mA}$

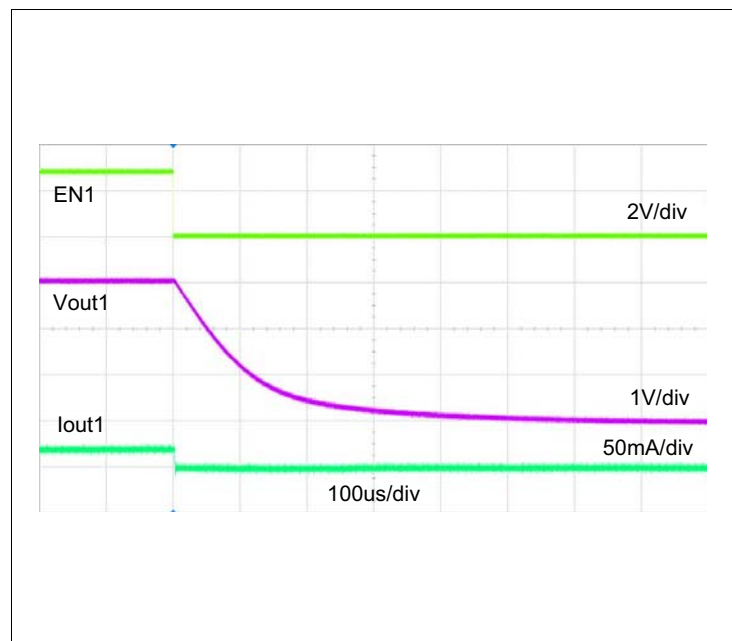




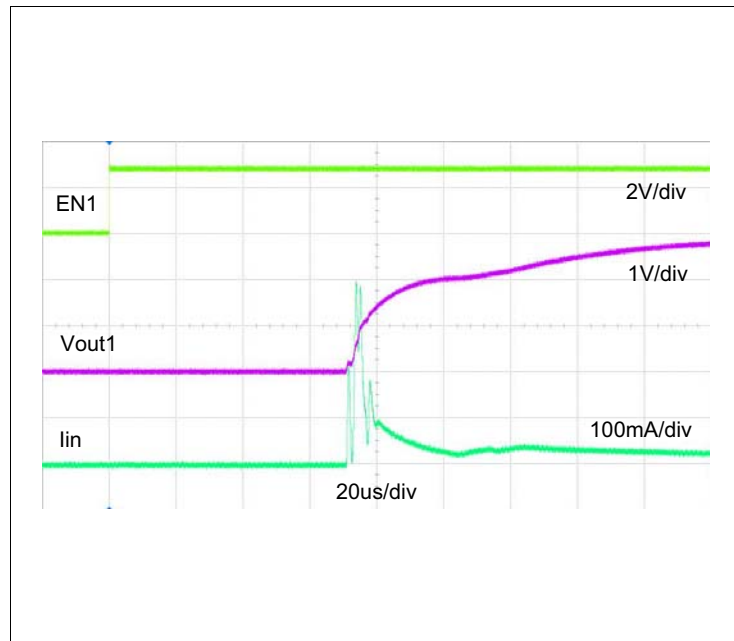
**Figure 26:**  
**Line Transient Response**



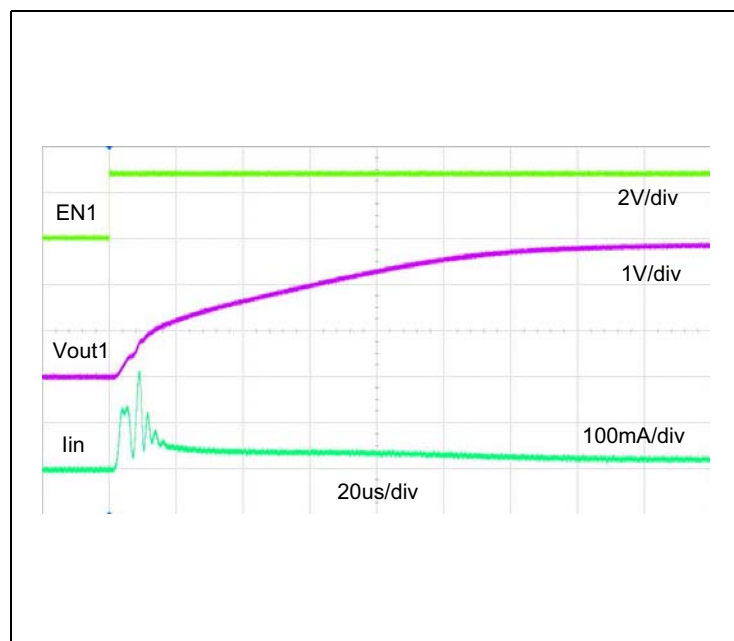
**Figure 27:**  
**Shutdown**



**Figure 28:**  
Startup of CH1 When CH2 is Off



**Figure 29:**  
Startup of CH1 When CH2 is On



## Detailed Description

Figure 3 shows the block diagram of the AS1374. It identifies the basics of a series linear regulator employing a P-Channel MOSFET as the control element. A stable voltage reference (REF in Figure 3) is compared with an attenuated sample of the output voltage. Any difference between the two voltages (reference and sample) creates an output from the error amplifier that drives the series control element to reduce the difference to a minimum. The error amplifier incorporates additional buffering to drive the relatively large gate capacitance of the series pass P-Channel MOSFET, when additional drive current is required under transient conditions. Input supply variations are absorbed by the series element, and output voltage variations with loading are absorbed by the low output impedance of the regulator.

### Output Voltage

The AS1374 deliver preset output voltages from 1.2V to 3.6V, in 50mV increments (see [Ordering Information](#)).

### Enable

The AS1374 feature an active high enable mode to shutdown each output independently. Driving EN 1 low disables Output 1, driving EN 2 low disables Output 2. The disabled Output enters a high-impedance state.

### Current Limit

The AS1374 include a current limiting circuitry to monitor and control the P-channel MOSFET pass transistor's gate voltage, thus limiting the device output current to 300mA.

**Note(s):** See [Figure 7](#) for the recommended min and max current limits. The output can be shorted to ground indefinitely without causing damage to the device.

### Thermal Protection

Integrated thermal protection circuitry limits total power dissipation in the AS1374. When the junction temperature ( $T_J$ ) exceeds 160°C, the thermal sensor signals the shutdown logic, turning off the P-channel MOSFET pass transistor and allowing the device to cool down. The thermal sensor turns the pass transistor on again after the device's junction temperature drops by 15°C, resulting in a pulsed output during continuous thermal-overload conditions.

**Note(s):** Thermal protection is designed to protect the devices in the event of fault conditions. For continuous operation, do not exceed the absolute maximum junction temperature rating of 150°C.

## Application Information

### Dropout Voltage

Dropout is the input to output voltage difference, below which the linear regulator ceases to regulate. At this point, the output voltage change follows the input voltage change. Dropout voltage may be measured at different load currents, but is usually specified at maximum output. As a result, the MOSFET maximum series resistance over temperature is obtained. More generally:

$$(EQ1) \quad V_{\text{DROPOUT}} = I_{\text{LOAD}} \times R_{\text{SERIES}}$$

Dropout is probably the most important specification when the regulator is used in a battery application. The dropout performance of the regulator defines the useful “end of life” of the battery before replacement or re-charge is required.

**Figure 30:**  
Graphical Representation of Dropout Voltage

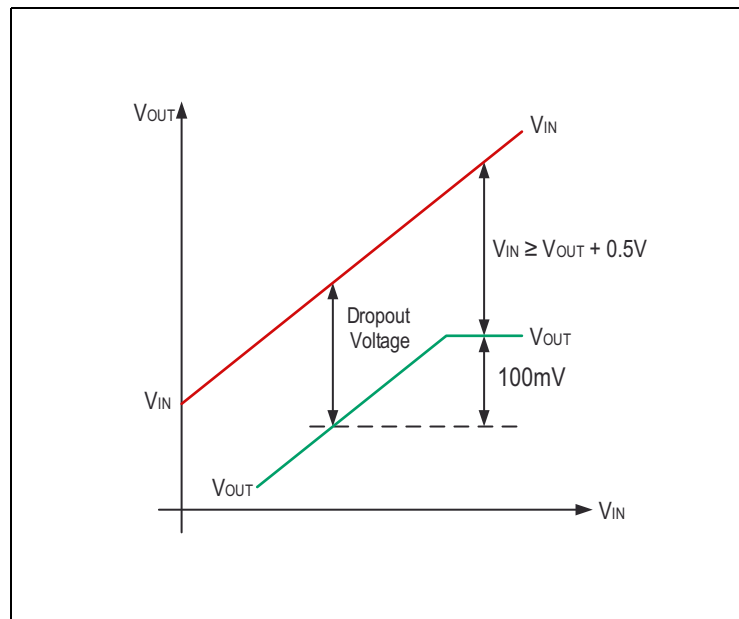


Figure 30 shows the variation of V<sub>OUT</sub> as V<sub>IN</sub> is varied for a certain load current. The practical value of dropout is the differential voltage (V<sub>OUT</sub> - V<sub>IN</sub>) measured at the point where the LDO output voltage has fallen by 100mV below the nominal, fully regulated output value. The nominal regulated output voltage of the LDO is that obtained when there is 500mV (or greater) input-output voltage differential.

## Efficiency

Low quiescent current and low input-output voltage differential are important in battery applications amongst others, as the regulator efficiency is directly related to quiescent current and dropout voltage. Efficiency is given by:

$$(EQ2) \quad \text{Efficiency} = \frac{V_{LOAD} \times I_{LOAD}}{V_{IN}(I_Q + I_{LOAD})} \times 100\%$$

Where:

$I_Q$  = Quiescent current of LDO

## Power Dissipation

Maximum power dissipation (PD) of the LDO is the sum of the power dissipated by the internal series MOSFET and the quiescent current required to bias the internal voltage reference and the internal error amplifier, and is calculated as:

$$(EQ3) \quad PD_{(MAX)}^{(Seriespass)} = I_{LOAD(MAX)}(V_{IN(MAX)} - V_{OUT(MIN)}) \text{ Watts}$$

Internal power dissipation as a result of the bias current for the internal voltage reference and the error amplifier is calculated as:

$$(EQ4) \quad PD_{(MAX)}^{(Bias)} = V_{IN(MAX)} I_Q \text{ Watts}$$

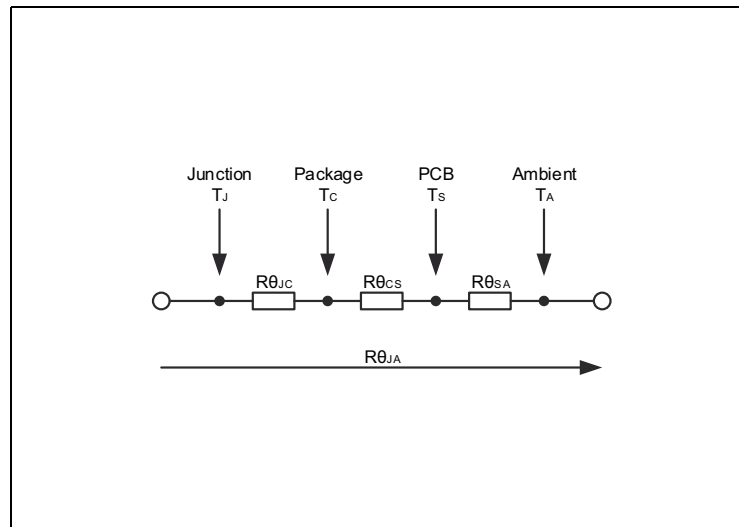
Total LDO power dissipation is calculated as:

$$(EQ5) \quad PD_{(MAX)}^{(Total)} = PD_{(MAX)}^{(Seriespass)} + PD_{(MAX)}^{(Bias)} \text{ Watts}$$

## Junction Temperature

Under all operating conditions, the maximum junction temperature should not be allowed to exceed 125°C (unless otherwise specified in the datasheet). Limiting the maximum junction temperature requires knowledge of the heat path from junction to case ( $\theta_{JC}$  °C/W fixed by the IC manufacturer), and adjustment of the case to ambient heat path ( $\theta_{CA}$  °C/W) by manipulation of the PCB copper area adjacent to the IC position.

**Figure 31:**  
Steady State Heat Flow Equivalent Circuit



Total Thermal Path Resistance:

$$(EQ6) \quad R_{\theta JA} = R_{\theta JC} + R_{\theta CS} + R_{\theta SA}$$

Junction Temperature (T<sub>J</sub> °C) is determined by:

$$(EQ7) \quad T_J = (PD_{(MAX)} \times R_{\theta JA}) + T_{AMB} \text{ } ^\circ\text{C}$$

## Explanation of Steady State Specifications

### Line Regulation

Line regulation is defined as the change in output voltage when the input (or line) voltage is changed by a known quantity. It is a measure of the regulator's ability to maintain a constant output voltage when the input voltage changes. Line regulation is a measure of the DC open loop gain of the error amplifier. More generally:

$$(EQ8) \quad \text{Line Regulation} = \frac{\Delta V_{OUT}}{\Delta V_{IN}} \text{ and is a pure number}$$

In practise, line regulation is referred to the regulator output voltage in terms of % /  $V_{OUT}$ . This is particularly useful when the same regulator is available with numerous output voltage trim options.

$$(EQ9) \quad \text{Line Regulation} = \frac{\Delta V_{OUT}}{\Delta V_{IN}} \times \frac{100}{V_{OUT}} \% / V$$

### Load Regulation

Load regulation is defined as the change of the output voltage when the load current is changed by a known quantity. It is a measure of the regulator's ability to maintain a constant output voltage when the load changes. Load regulation is a measure of the DC closed loop output resistance of the regulator. More generally:

$$(EQ10) \quad \text{Load Regulation} = \frac{\Delta V_{OUT}}{\Delta I_{OUT}} \text{ and is units of Ohms } (\Omega)$$

In practise, load regulation is referred to the regulator output voltage in terms of % / mA. This is particularly useful when the same regulator is available with numerous output voltage trim options.

$$(EQ11) \quad \text{Load Regulation} = \frac{\Delta V_{OUT}}{\Delta I_{OUT}} \times \frac{100}{V_{OUT}} \% / \text{mA}$$

### Setting Accuracy

Accuracy of the final output voltage is determined by the accuracy of the ratio of R1 and R2, the reference accuracy and the input offset voltage of the error amplifier. When the regulator is supplied pre-trimmed, the output voltage accuracy is fully defined in the output voltage specification.

When the regulator has a SET terminal, the output voltage may be adjusted externally. In this case, the tolerance of the external resistor network must be incorporated into the final accuracy calculation. Generally:

$$(EQ12) \quad V_{OUT} = (V_{SET} \pm \Delta V_{SET}) \left( 1 + \frac{R1 \pm \Delta R1}{R2 \pm \Delta R2} \right)$$

The reference tolerance is given both at 25°C and over the full operating temperature range.

**Total Accuracy**

Away from dropout, total steady state accuracy is the sum of setting accuracy, load regulation and line regulation. Generally:

$$(EQ13) \quad \text{Total \% Accuracy} = \text{Setting \% Accuracy} + \text{Load Regulation \%} + \text{Line Regulation \%}$$

**Explanation of Dynamic Specifications****Power Supply Rejection Ratio (PSRR)**

Known also as Ripple Rejection, this specification measures the ability of the regulator to reject noise and ripple beyond DC. PSRR is a summation of the individual rejections of the error amplifier, reference and AC leakage through the series pass transistor. The specification, in the form of a typical attenuation plot with respect to frequency, shows up the gain bandwidth compromises forced upon the designer in low quiescent current conditions. Generally:

$$(EQ14) \quad \text{PSRR} = 20 \text{Log} \frac{\delta V_{\text{OUT}}}{\delta V_{\text{IN}}} \text{ dB using lower case } \delta \text{ to indicate AC values}$$

Power supply rejection ratio is fixed by the internal design of the regulator. Additional rejection must be provided externally. The AS1374 is designed to deliver low noise and high PSRR, with low quiescent currents in battery-powered systems. The power-supply rejection is 85dB at 1kHz and 50dB at 100kHz. When operating from sources other than batteries, improved supply-noise rejection and transient response are achieved by increasing the values of the input and output capacitors. Additional passive LC filtering at the input can provide enhanced rejection at high frequencies.

**Output Capacitor ESR**

The series regulator is a negative feedback amplifier, and as such is conditionally stable. The ESR of the output capacitor is usually used to cancel one of the open loop poles of the error amplifier in order to produce a single pole response. Excessive ESR values may actually cause instability by excessive changes to the closed loop unity gain frequency crossover point. The range of ESR values for stability is usually shown either by a plot of stable ESR versus load current, or a maximum value in the datasheet.

Some ceramic capacitors exhibit large capacitance and ESR variations with variations in temperature. Z5U and Y5V capacitors may be required to ensure stability at temperatures below  $T_{\text{AMB}} = -10^{\circ}\text{C}$ . With X7R or X5R capacitors, a 1 $\mu\text{F}$  capacitor should be sufficient at all operating temperatures.

Larger output capacitor values (10 $\mu\text{F}$ ) help to reduce noise and improve load transient-response, stability and power-supply rejection.



### **Input Capacitor**

An input capacitor at  $V_{IN}$  is required for stability. It is recommended that a 1.0 $\mu$ F capacitor be connected between the AS1369 power supply input pin  $V_{IN}$  and ground (capacitance value may be increased without limit subject to ESR limits). This capacitor must be located at a distance of not more than 1 cm from the  $V_{IN}$  pin and returned to a clean analog ground. Any good quality ceramic, tantalum, or film capacitor may be used at the input.

### **Noise**

The regulator output is a DC voltage with noise superimposed on the output. The noise comes from three sources; the reference, the error amplifier input stage, and the output voltage setting resistors. Noise is a random fluctuation and if not minimized in some applications, will produce system problems.

### **Transient Response**

The series regulator is a negative feedback system, and therefore any change at the output will take a finite time to be corrected by the error loop. This “propagation time” is related to the bandwidth of the error loop. The initial response to an output transient comes from the output capacitance, and during this time, ESR is the dominant mechanism causing voltage transients at the output. More generally:

$$(EQ15) \quad \delta V_{TRANSIENT} = \delta I_{OUTPUT} \times R_{ESR} \quad \text{Units are Volts, Amps, Ohms.}$$

Thus an initial +50mA change of output current will produce a -12mV transient when the ESR=240m $\Omega$ . Do remember to keep the ESR within stability recommendations when reducing ESR by adding multiple parallel output capacitors.

After the initial ESR transient, there follows a voltage droop during the time that the LDO feedback loop takes to respond to the output change. This drift is approx. linear in time and sums with the ESR contribution to make a total transient variation at the output of:

$$(EQ16) \quad \delta V_{TRANSIENT} = \delta I_{OUTPUT} \times \left( R_{ESR} + \frac{T}{C_{LOAD}} \right)$$

Units are Volts, Seconds, Farads, Ohms.

Where:

$C_{LOAD}$  is output capacitor

T= Propagation Delay of the LDO

This shows why it is convenient to increase the output capacitor value for a better support for fast load changes. Of course the formula holds for  $t < \text{“propagation time”}$ , so that a faster LDO needs a smaller cap at the load to achieve a similar transient response.

For instance 50mA load current step produces 50mV output drop if the LDO response is 1 $\mu$ s and the load cap is 1 $\mu$ F.

There is also a steady state error caused by the finite output impedance of the regulator. This is derived from the load regulation specification discussed above.

### ***Turn On Time***

This specification defines the time taken for the LDO to awake from shutdown. The time is measured from the release of the enable pin to the time that the output voltage is within 5% of the final value. It assumes that the voltage at VIN is stable and within the regulator min and max limits. Shutdown reduces the quiescent current to very low, mostly leakage values (<1 $\mu$ A).

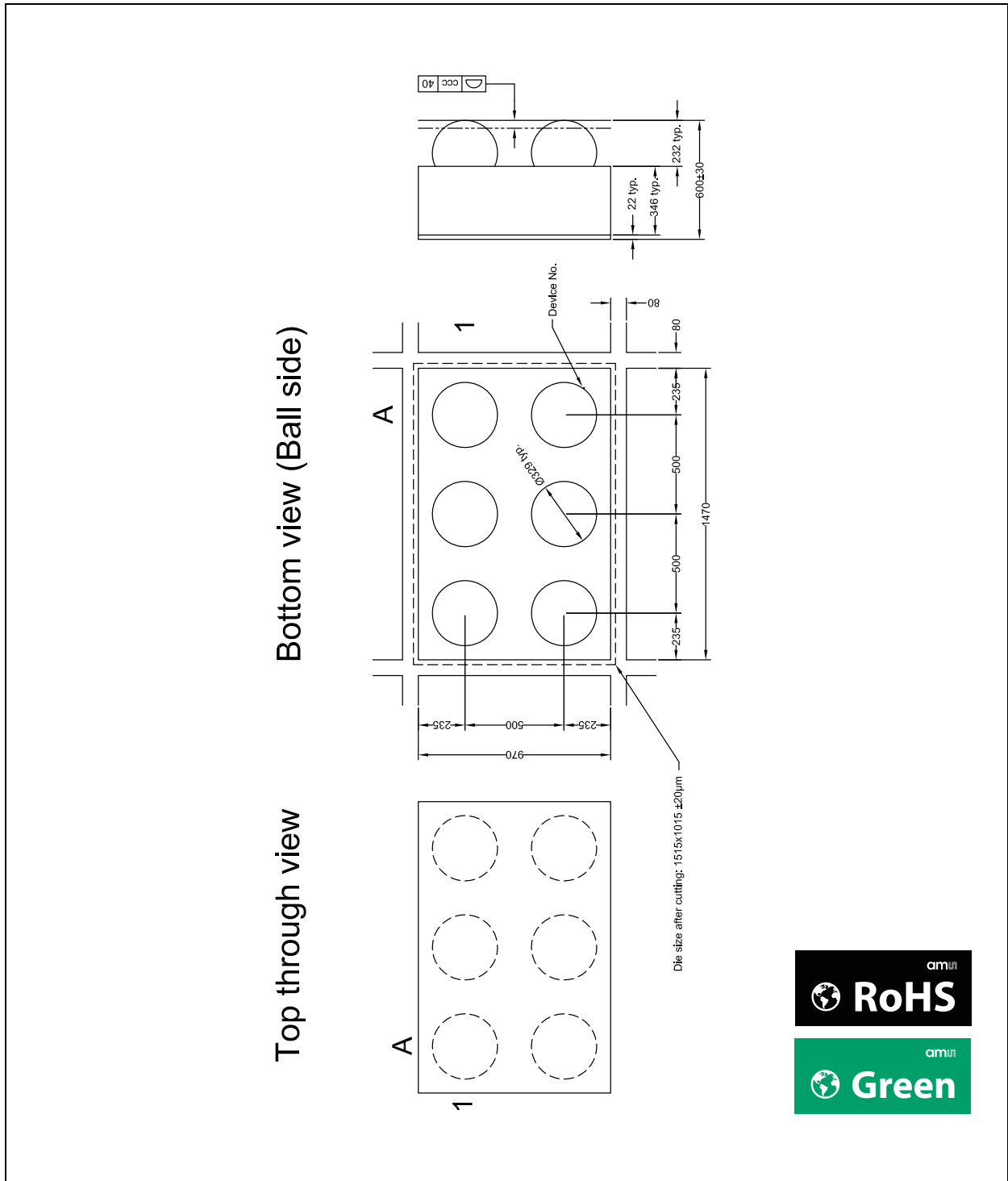
### ***Thermal Protection***

To prevent operation under extreme fault conditions, such as a permanent short circuit at the output, thermal protection is built into the device. Die temperature is measured, and when a 160°C threshold is reached, the device enters shutdown. When the die cools sufficiently, the device will restart (assuming input voltage exists and the device is enabled). Hysteresis of 15°C prevents low frequency oscillation between start-up and shutdown around the temperature threshold.

## Package Drawings & Markings

The AS1374 is available in a 6-bump WLCSP package.

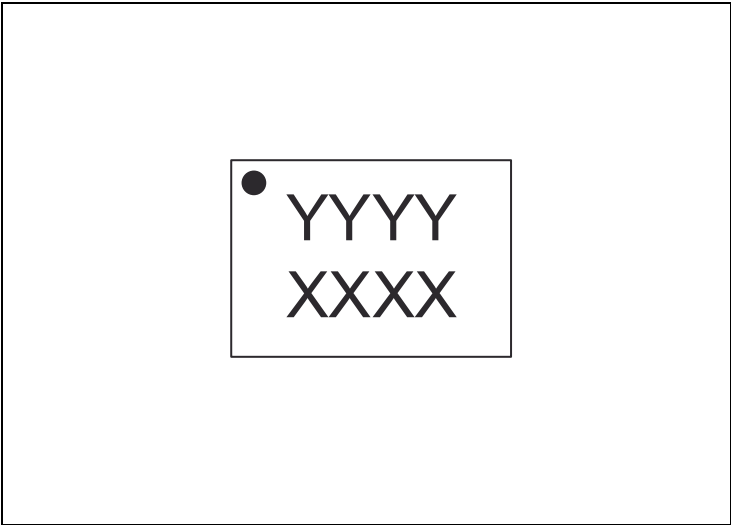
**Figure 32:**  
6-Bump WLCSP Package



**Note(s):**

1. Pin 1 = A1
2. ccc coplanarity
3. All dimensions are in μm.

**Figure 33:  
Package Marking**



**Figure 34:  
Packaging Code**

YYYYY	XXXXX
Marking	Tracecode

## Ordering & Contact Information

The devices are available as the standard products shown in [Figure 35](#).

**Figure 35:**  
**Ordering Information**

Ordering Code	Marking	Package	Output Voltage 1	Output Voltage 2	Delivery Form	Delivery Quantity
AS1374-BWLT-285 <sup>(1)</sup>	ASSH	6-bump WLCSP	2.85V	2.85V	Tape & Reel	10k pcs/reel
AS1374-BWLT1833	ASSJ	6-bump WLCSP	1.8V	3.3V	Tape & Reel	10k pcs/reel
AS1374-BWLT1818	ASSP	6-bump WLCSP	1.8V	1.8V	Tape & Reel	10k pcs/reel
AS1374-BWLT1218	ASSK	6-bump WLCSP	1.2V	1.8V	Tape & Reel	10k pcs/reel
AS1374-BWLT1214	ASSY	6-bump WLCSP	1.2V	1.4V	Tape & Reel	10k pcs/reel
AS1374-BWLT18285	ASSZ	6-bump WLCSP	1.8V	2.85V	Tape & Reel	10k pcs/reel
AS1374-BWLT1212	ASSW	6-bump WLCSP	1.2V	1.2V	Tape & Reel	10k pcs/reel
AS1374-BWLT1827	ASTB	6-bump WLCSP	1.8V	2.7V	Tape & Reel	10k pcs/reel
AS1374-BWLT1533 <sup>(1)</sup>	ASTF	6-bump WLCSP	1.5V	3.3V	Tape & Reel	10k pcs/reel
AS1374-BWLT1820 <sup>(1)</sup>	ASTG	6-bump WLCSP	1.8V	2.0V	Tape & Reel	10k pcs/reel
AS1374-BWLT1821 <sup>(1)</sup>	ASTH	6-bump WLCSP	1.8V	2.1V	Tape & Reel	10k pcs/reel
AS1374-BWLT2533 <sup>(1)</sup>	ASTI	6-bump WLCSP	2.5V	3.3V	Tape & Reel	10k pcs/reel
AS1374-BWLT-1518 <sup>(1)</sup>	ASTK	6-bump WLCSP	1.5V	1.8V	Tape & Reel	10k pcs/reel
AS1374-BWLT-1530 <sup>(1)</sup>	ASTX	6-bump WLCSP	1.5V	3.0V	Tape & Reel	10k pcs/reel
AS1374-BWLT-2525 <sup>(1)</sup>	ASV7	6-bump WLCSP	2.5V	2.5V	Tape & Reel	10k pcs/reel
AS1374-BWLT-1825 <sup>(1)</sup>	ASV8	6-bump WLCSP	1.8V	2.5V	Tape & Reel	10k pcs/reel
AS1374-BWLT <sup>(2)</sup>	—	6-bump WLCSP	tbd	tbd	Tape & Reel	10k pcs/reel

**Note(s):**

1. On request
2. Non-standard devices from 1.2V to 3.6V are available in 50mV steps. For more information and inquiries contact [www.ams.com/contact](http://www.ams.com/contact)

Buy our products or get free samples online at:

[www.ams.com/ICdirect](http://www.ams.com/ICdirect)

Technical Support is available at:

[www.ams.com/Technical-Support](http://www.ams.com/Technical-Support)

Provide feedback about this document at:

[www.ams.com/Document-Feedback](http://www.ams.com/Document-Feedback)

For further information and requests, e-mail us at:

[ams\\_sales@ams.com](mailto:ams_sales@ams.com)

For sales offices, distributors and representatives, please visit:

[www.ams.com/contact](http://www.ams.com/contact)

#### **Headquarters**

ams AG

Tobelbaderstrasse 30

8141 Premstaetten

Austria, Europe

Tel: +43 (0) 3136 500 0

Website: [www.ams.com](http://www.ams.com)

## RoHS Compliant & ams Green Statement

**RoHS:** The term RoHS compliant means that ams AG products fully comply with current RoHS directives. Our semiconductor products do not contain any chemicals for all 6 substance categories, including the requirement that lead not exceed 0.1% by weight in homogeneous materials. Where designed to be soldered at high temperatures, RoHS compliant products are suitable for use in specified lead-free processes.

**ams Green (RoHS compliant and no Sb/Br):** ams Green defines that in addition to RoHS compliance, our products are free of Bromine (Br) and Antimony (Sb) based flame retardants (Br or Sb do not exceed 0.1% by weight in homogeneous material).

**Important Information:** The information provided in this statement represents ams AG knowledge and belief as of the date that it is provided. ams AG bases its knowledge and belief on information provided by third parties, and makes no representation or warranty as to the accuracy of such information. Efforts are underway to better integrate information from third parties. ams AG has taken and continues to take reasonable steps to provide representative and accurate information but may not have conducted destructive testing or chemical analysis on incoming materials and chemicals. ams AG and ams AG suppliers consider certain information to be proprietary, and thus CAS numbers and other limited information may not be available for release.

## Copyrights & Disclaimer

Copyright ams AG, Tobelbader Strasse 30, 8141 Premstaetten, Austria-Europe. Trademarks Registered. All rights reserved. The material herein may not be reproduced, adapted, merged, translated, stored, or used without the prior written consent of the copyright owner.

Devices sold by ams AG are covered by the warranty and patent indemnification provisions appearing in its General Terms of Trade. ams AG makes no warranty, express, statutory, implied, or by description regarding the information set forth herein. ams AG reserves the right to change specifications and prices at any time and without notice. Therefore, prior to designing this product into a system, it is necessary to check with ams AG for current information. This product is intended for use in commercial applications. Applications requiring extended temperature range, unusual environmental requirements, or high reliability applications, such as military, medical life-support or life-sustaining equipment are specifically not recommended without additional processing by ams AG for each application. This product is provided by ams AG "AS IS" and any express or implied warranties, including, but not limited to the implied warranties of merchantability and fitness for a particular purpose are disclaimed.

ams AG shall not be liable to recipient or any third party for any damages, including but not limited to personal injury, property damage, loss of profits, loss of use, interruption of business or indirect, special, incidental or consequential damages, of any kind, in connection with or arising out of the furnishing, performance or use of the technical data herein. No obligation or liability to recipient or any third party shall arise or flow out of ams AG rendering of technical or other services.



## Document Status

Document Status	Product Status	Definition
Product Preview	Pre-Development	Information in this datasheet is based on product ideas in the planning phase of development. All specifications are design goals without any warranty and are subject to change without notice
Preliminary Datasheet	Pre-Production	Information in this datasheet is based on products in the design, validation or qualification phase of development. The performance and parameters shown in this document are preliminary without any warranty and are subject to change without notice
Datasheet	Production	Information in this datasheet is based on products in ramp-up to full production or full production which conform to specifications in accordance with the terms of ams AG standard warranty as given in the General Terms of Trade
Datasheet (discontinued)	Discontinued	Information in this datasheet is based on products which conform to specifications in accordance with the terms of ams AG standard warranty as given in the General Terms of Trade, but these products have been superseded and should not be used for new designs

## Revision Information

Changes from 1.8 (2011-Dec-12) to current revision 2-00 (2016-Jun-22)	Page
Content of austriamicrosystems datasheet was converted to latest <b>ams</b> design	
Added benefits to Key Features	
Updated all drawings	
Updated Figure 6	5
Updated Typical Operating Characteristics section	8
Updated Package Drawings & Markings section	27
Updated Figure 35	29

**Note(s):**

1. Page and figure numbers for the previous version may differ from page and figure numbers in the current revision.
2. Correction of typographical errors is not explicitly mentioned.

## Content Guide

<b>1</b>	<b>General Description</b>
1	Key Benefits & Features
2	Applications
3	Block Diagram
<b>4</b>	<b>Pin Assignment</b>
<b>5</b>	<b>Absolute Maximum Ratings</b>
<b>6</b>	<b>Electrical Characteristics</b>
<b>8</b>	<b>Typical Operating Characteristics</b>
<b>19</b>	<b>Detailed Description</b>
19	Output Voltage
19	Enable
19	Current Limit
19	Thermal Protection
<b>20</b>	<b>Application Information</b>
20	Dropout Voltage
21	Efficiency
21	Power Dissipation
22	Junction Temperature
23	Explanation of Steady State Specifications
23	Line Regulation
23	Load Regulation
23	Setting Accuracy
24	Total Accuracy
24	Explanation of Dynamic Specifications
24	Power Supply Rejection Ratio (PSRR)
24	Output Capacitor ESR
25	Input Capacitor
25	Noise
25	Transient Response
26	Turn On Time
26	Thermal Protection
<b>27</b>	<b>Package Drawings &amp; Markings</b>
<b>29</b>	<b>Ordering &amp; Contact Information</b>
<b>31</b>	<b>RoHS Compliant &amp; ams Green Statement</b>
<b>32</b>	<b>Copyrights &amp; Disclaimer</b>
<b>33</b>	<b>Document Status</b>
<b>34</b>	<b>Revision Information</b>

## X-ON Electronics

Largest Supplier of Electrical and Electronic Components

*Click to view similar products for [Audio IC Development Tools](#) category:*

*Click to view products by [ams](#) manufacturer:*

Other Similar products are found below :

[LM4906MMBD](#) [LM4935RLEVAL](#) [LME49710NABD](#) [LME49740MABD](#) [LME49740NABD](#) [LME49860MABD](#) [LME49870MABD](#) [EVAL-AD1940AZ](#) [EVAL-ADAU1401AEBZ](#) [SRC4382EVM-PDK](#) [TLV320AIC36EVM-K](#) [TPA5052EVM](#) [TPA6136A2YFFEVM](#) [LM4562HABD](#) [LM4906LDBD](#) [LM4923LQBD](#) [LM4992SDBD](#) [LME49710MABD](#) [LME49713MABD](#) [LME49860NABD](#) [MAX98300EVKIT+WLP](#) [MAX9738EVKIT+](#) [MAX98358EVSYS#WLP](#) [MAX9723DEVKIT+](#) [EVAL-ADAV803EBZ](#) [MAX9709EVKIT](#) [LM4809MBD](#) [LM4674TLBD](#) [CDBWM8725-M-1](#) [CDBWM8533-M-1](#) [EV\\_ICS-40740-FX](#) [SDCK3](#) [PIM524](#) [MAX9723DEVCMODU+](#) [DEV-17737](#) [MAX9850EVCMOD2#](#) [EVALAHNBIM69D130V01TOBO1](#) [1063](#) [TAS5756MDCAEVM](#) [TLV320ADC3101EVM-K](#) [TLV320AIC3007EVM-K](#) [TLV320AIC3105EVM-K](#) [TLV320AIC3253EVM-K](#) [TPA2016D2EVM](#) [TPA2035D1EVM](#) [TPA2051D3YFFEVM](#) [TPA3107D2EVM](#) [TPA6120A2EVM](#) [TPA6132A2EVM2](#) [MIKROE-2454](#)