



Eval Kit Manual

AS3722

Standard Board

AS3722-CT-00_EK_ST AS3728

Table of Contents

1	Introduction	3
1.1	Kit Content	4
2	Getting Started	5
3	Hardware Description.....	6
4	Software Description	8
4.1	LDO	9
4.2	DCDC	10
4.2.1	DCDC0, DCDC1, DCDC6.....	10
4.2.2	DCDC2 – DCDC5	11
4.2.3	OC_PG / PWM Settings.....	12
5	Schematics, Layers and BOM	13
5.1	Schematics of AS3722 and AS3728 Evaluation Board	14
5.2	Board Layout of AS3722 and AS3728 Evaluation Board	18
5.3	BOM	21
6	Ordering & Contact Information	22
7	Copyrights & Disclaimer.....	23
8	Revision Information	24

1 Introduction

This document describes the AS3722 and AS3728 Evaluation Kit.

The AS3722 is a compact System PMU supporting up to 20 high current rails. It features 4 DCDC buck converters as well as 12 low noise LDOs. The different regulated supply voltages are programmable via the serial control interface. AS3722 further features 3DCDC buck controllers which are ideal to support processor currents ranging from 5A up to 32A.

The single supply voltage may vary from 2.5V to 5.5V

The Evaluation Kit has to be externally supplied. The graphical user interface (GUI) runs on PC running Windows 7 and allows the user to control the AS3722. Use the enclosed USB cable to connect the PC with the Evaluation board.

The AS3728 is a companion power stage, intended to be used with AS372x products.

It cannot be used without a DCDC controller. It contains the power FETs for 2 phases and is capable to handle output currents of 4A per phase.

1.1 Kit Content

The AS3722 and AS3728 Evaluation Kit include all items listed in Figure 1: Kit Content.

Figure 1: Kit Content

Item	Comment
USB flash drive	Includes document and software
Evaluation board	AS3722 and AS3728
USB connection cable	

2 Getting Started

Drive the AS3722 and AS3728 only with the recommended settings and values as described in the datasheet. Please check www.ams.com for the latest version.

For a detailed description of the Kit please read sections 3-5 of this document.

- Install the GUI from the attached USB flash drive
- Establish the connection between PC and Evaluation board via the enclosed USB cable
- Supply AS3722 Evaluation Board with the battery which is included in this kit. Check first if the battery is loaded (~ 3.7 VDC).
- Connect the battery to VBAT and GND. Make sure that all four Jumpers are set between J43 and J44 in order to connect VBAT to VSUP.
- Remain all other Jumpers in the default setting (ex-factory).
- Start the GUI and connect the USB Box to a PC USB Port.
- First of all please **perform a firmware upgrade** on the Evaluation board in order to ensure a proper communication to the GUI! The appropriate firmware file for the Evaluation board comes with the GUI software and can be found in the GUI installation directory (default: C:\Program Files (x86)\ams\AS372x Evaluation Software\firmware). Open “Help” in the top command bar and press “Firmware update” to initiate the procedure. Never disconnect the battery or interrupt the connection to the PC during the update!!!
- If the AS3722 Evaluation Board is supplied and connected properly to the PC and the appropriate firmware file is installed, the field at the right bottom corner of the GUI becomes green

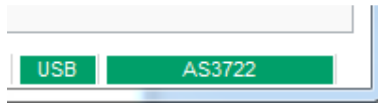



For further information do not hesitate to contact us.

3 Hardware Description

The AS3722 and AS3728 Evaluation Board can be powered via an external power supply or via battery (label E). The AS3722 and AS3729 can be controlled with the onboard μ C or any other controller board via 10 pole connector which enables fast code debugging (label D).

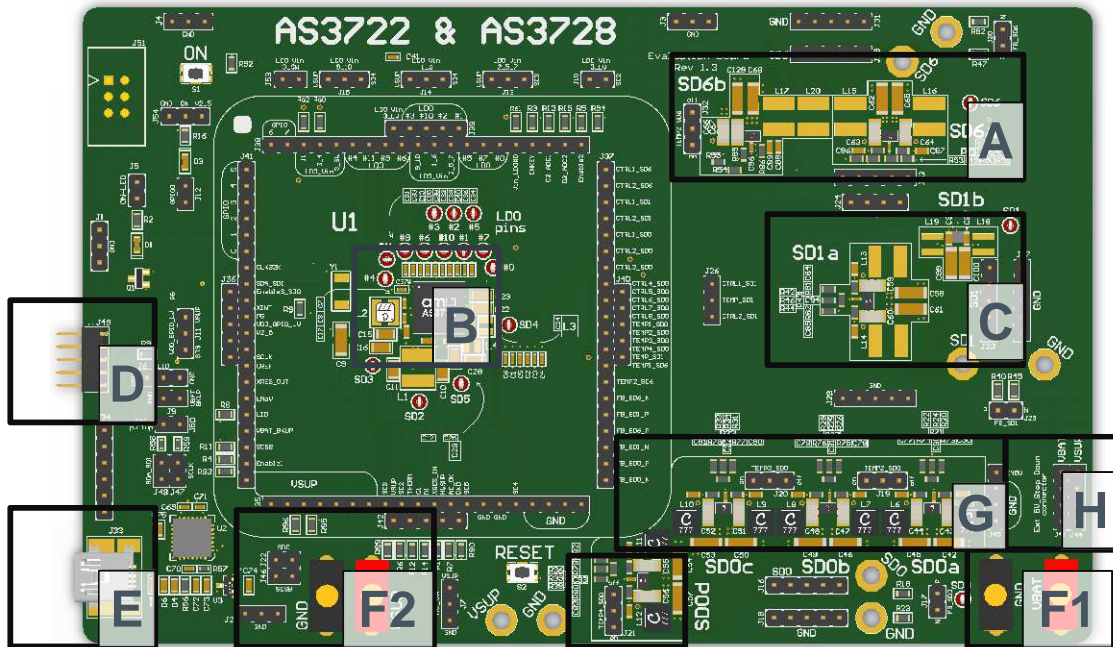
Figure 2: Evaluation Board Overview



Label	Name	Designator	Description	Info
A	SD6	SD6a, SD6b	2 pcs. AS3728 external Power Stages providing max. 12A	Can be used in a special mode using 2 phases with 2 power stages which provides up to 12A. Requires coils capable of supporting 6A each
B	AS3722	U1		PMU supporting up to 20 high current rails
C	SD1	SD1	1 pc. AS3728 external Power Stage providing max. 6A	Support for single, dual or combined phase(s) operation, 3A per phase
D	Controller interface	J49	Controller interface	Can be connected to an external controller
E	USB connector	J33	USB Mini B	Interface to the PC
F1 F2	VBAT, GND VSUP, GND	BU1, BU2 BU11, BU12	VBAT VSUP	Voltage Range: 2.7V to 5.5V. You can use the Battery for VBAT and an ext. Supply for VSUP (default: no jumper on J43, J44) or one ext. Supply on VBAT with jumper on J34, J44).
G	SD0	SD0a, SD0b, SD0c, SD0d	4 pcs. AS3728 external Power Stages providing max. 24A	The output current is easily scalable by varying the number of phases and power-stages from 3A up to 24A
H	VBAT to VSUP	J43, J44	Connect VBAT to VSUP	<p>With this jumper setting the max. permissible voltage supply is 5.5V. Default setting = all 4 Jumpers are set between J43 and J44.</p>  <p>J43 J44</p>

4 Software Description

The graphical user interface (GUI) is used to control the AS3722 Evaluation board.

Start the GUI and setup the Hardware according section **Error! Reference source not found.**
Error! Reference source not found.

Make sure hardware is recognized and indicators on the bottom right side of the GUI are green colored.

Figure 3: AS3722 Evaluation Software

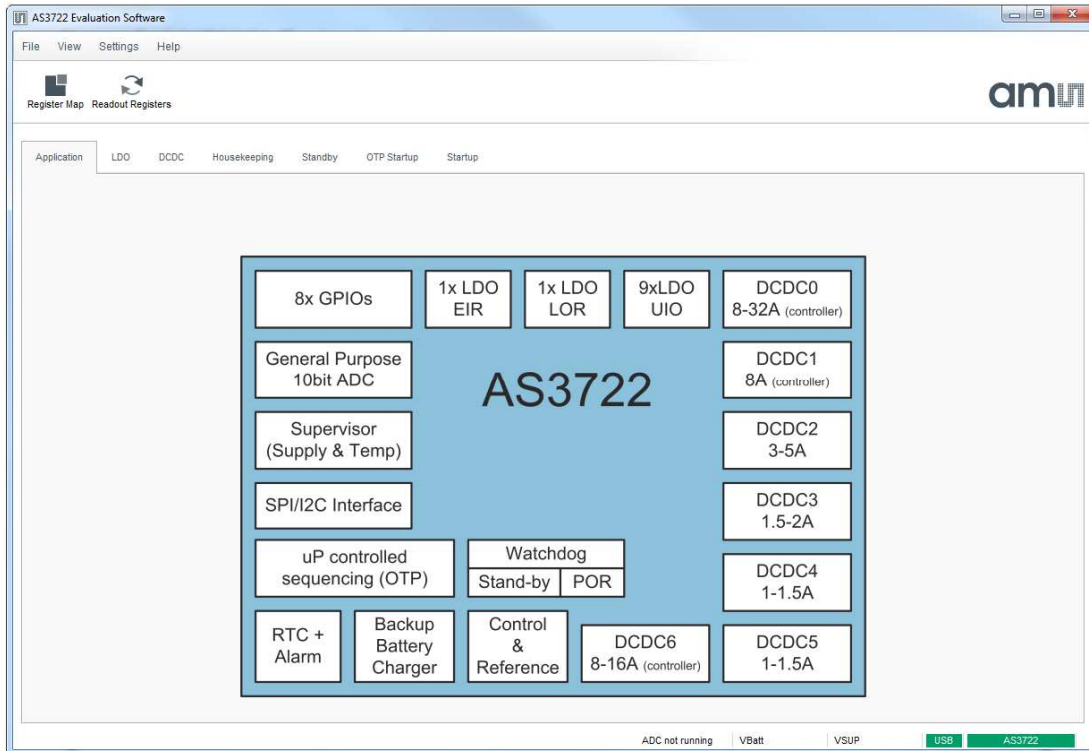

4.1 LDO

The AS3722 features 12 low noise LDO's.

Figure 4: LDO Settings

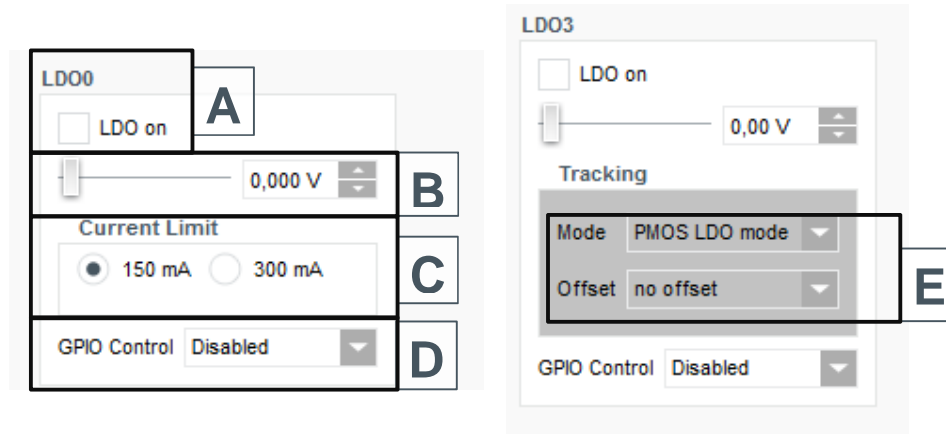

Label	Name	Comment
A	LDO on	Enabling / Disabling of LDOs
B	Vout Regulator	Output voltage
C	Current Limit	Minimum current Limit setting
D	GPIO Control	GPIO controlling of LDOs
E	Tracking	LDO3 works independent or tracks the Vout of DCDC1

4.2 DCDC

4.2.1 DCDC0, DCDC1, DCDC6

The AS3720 features 3 DCDC step down controller which are generally used in combination with the external Power Stages AS3729.

Figure 5: Settings for DCDC controllers

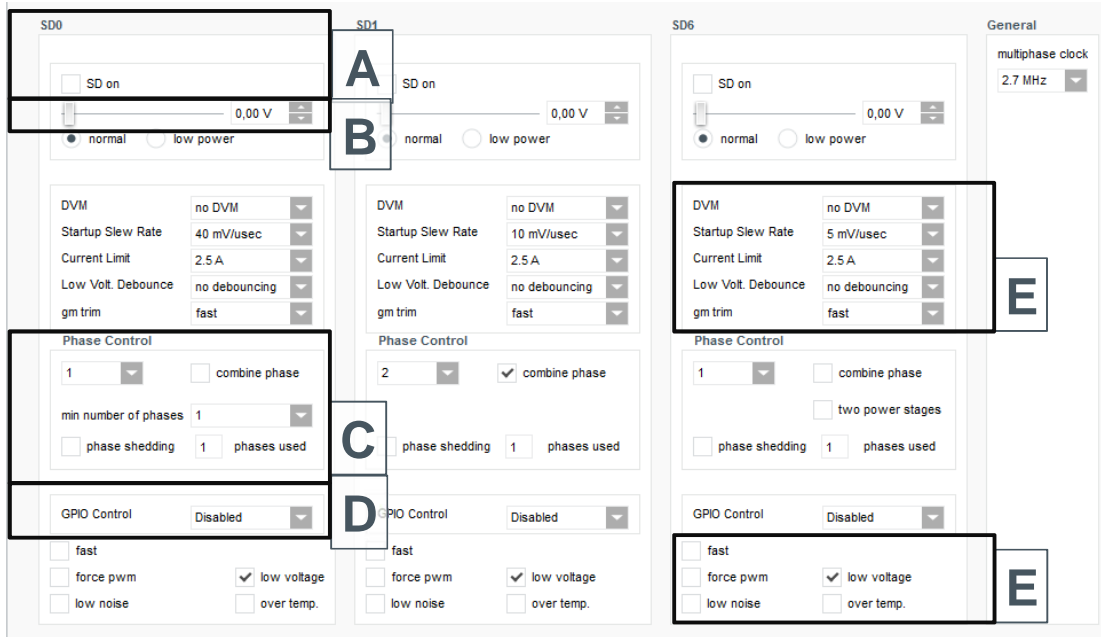

Label	Name	Comment
A	SD on	Enabling / Disabling of DCDCs
B	Vout Regulator	Output voltage
C	Phase Control	SD0: Up to 4 Power Stages and 8 phases can be used. As well as a combined mode of phases 1 and 2, 3 and 4, 5 and 6, 7 and 8 is possible. SD1 and SD6: Support for single, dual or combined phase(s) operation
D	GPIO Control	GPIO controlling of DCDCs
E	Mode Settings	For further details please refer to the AS3720/21 datasheet. The latest version of the datasheet can be found on our homepage, www.ams.com

4.2.2 DCDC2 – DCDC5

The AS3722 features 4 DCDC step down regulators.

Figure 6: Settings for DCDC regulators

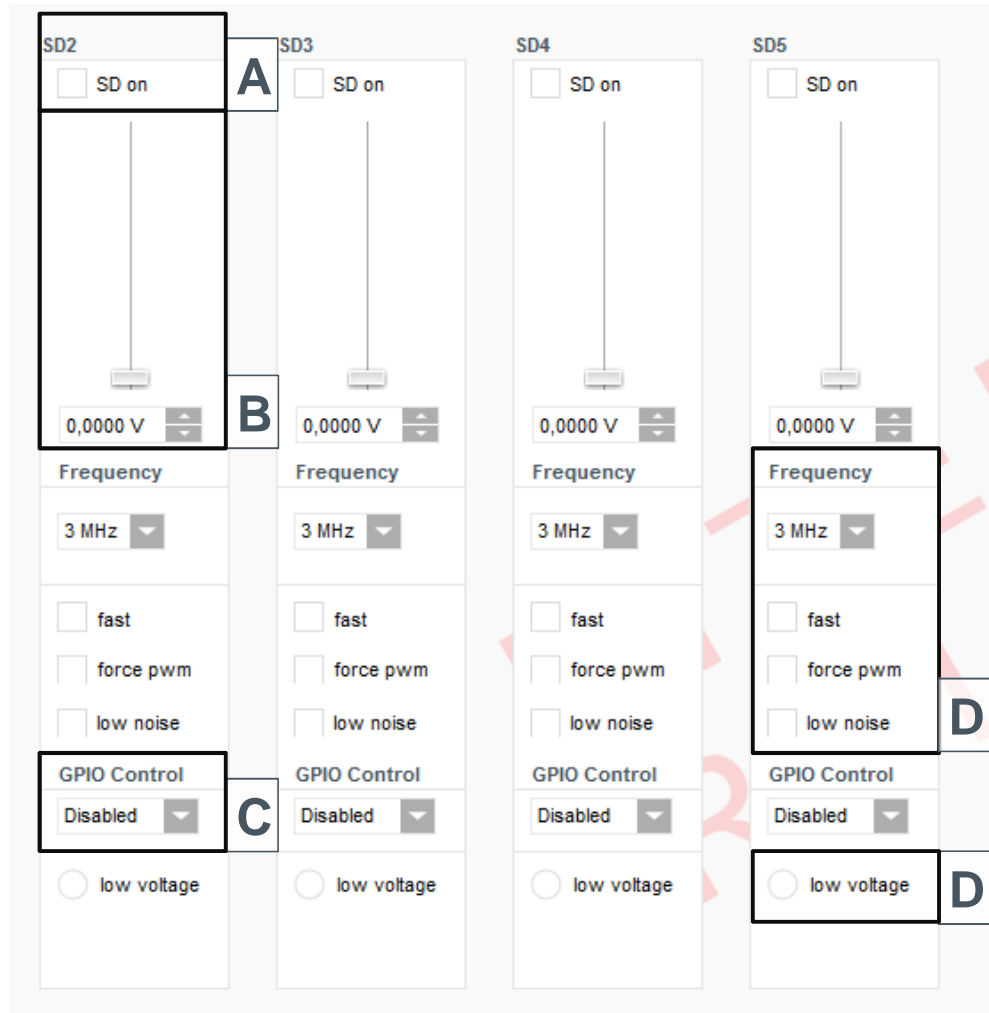

Label	Name	Comment
A	SD on	Enabling / Disabling of DCDCs
B	Vout Regulator	Output voltage
C	GPIO Control	GPIO controlling of DCDCs
D	Mode Settings	For further details please refer to the AS3720/21 datasheet. The latest version of the datasheet can be found on our homepage, www.ams.com

4.2.3 OC_PG / PWM Settings

The AS3722 features for SD0 a PWM Control.

<p>SD0 Over Current / Power Good</p> <p>SD0 ovc alarm: disabled SD0 ovc alarm debounce: no debouncing <input type="checkbox"/> Over Current</p> <p><input type="checkbox"/> SD0 over current mask SD0 oc-pg mask time: no masking</p> <p><input type="checkbox"/> SD0 power good mask <input type="checkbox"/> VresFall mask</p> <p><input type="checkbox"/> GPIO5 mask</p> <p><input type="checkbox"/> GPIO4 mask</p> <p><input type="checkbox"/> GPIO3 mask</p> <p><input type="checkbox"/> AC_OK mask <input type="checkbox"/> pg_ac_ok invert <input type="checkbox"/> oc_pg invert</p>	<p>PWM Control</p> <p><input type="checkbox"/> SD0 PWM Control <input checked="" type="radio"/> 10mV steps <input type="radio"/> 20mV steps</p> <p>Base: 0.6V vpwm1 reset: vpwm1_on & vpwm1_val</p> <p>Value: 0.60V max: 1.28V</p> <p><input type="checkbox"/> SD6 PWM Control <input checked="" type="radio"/> 10mV steps <input type="radio"/> 20mV steps</p> <p>Base: 0.6V vpwm2 reset: vpwm2_on & vpwm2_val</p> <p>Value: 0.60V max: 1.28V</p>
<p>SD6 overcurrent</p> <p>SD6 oVC alarm: disabled</p> <p><input type="checkbox"/> SD6 over current mask SD6 oc-pg mask time: no masking</p> <p><input type="checkbox"/> SD6 power good mask</p>	

5 Schematics, Layers and BOM

The AS3722 and AS3728 Evaluation Board is a 6-layer FR4 board. The main components are the AS3722 together with the Power Stages AS3728 plus additionally some active components, passive components, several test points and connectors.

Figure 7: AS3722 and AS3728 PCB Layer Stack up

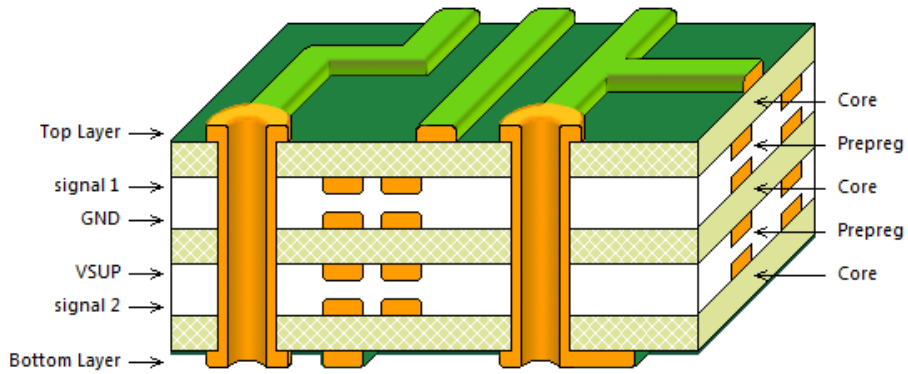

Figure 9: Schematic page 2

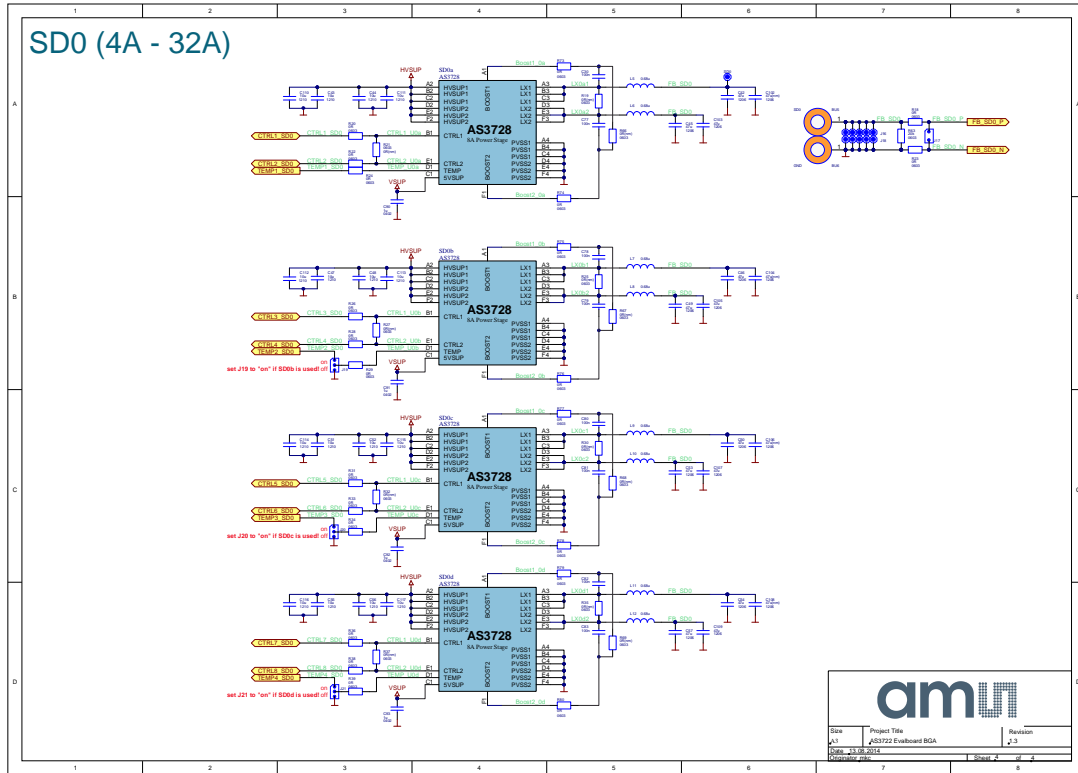

Figure 10: Schematic page 3

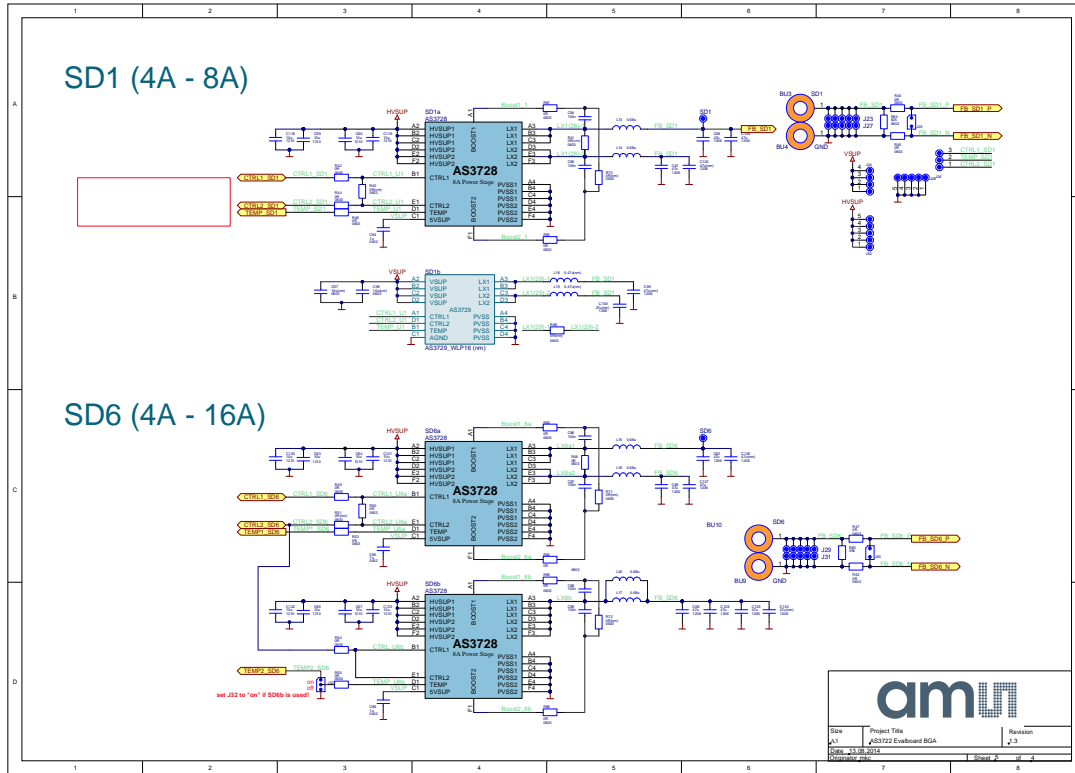
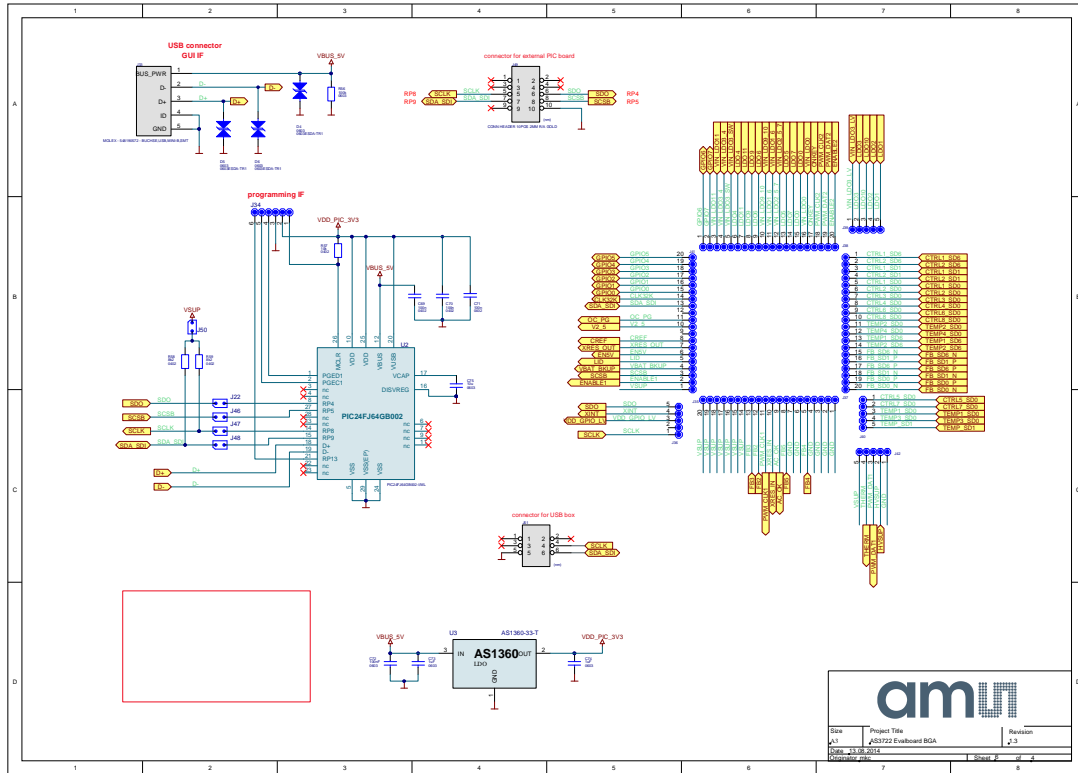

Figure 11: Schematic page 4



5.2 Board Layout of AS3722 and AS3728 Evaluation Board

Figure 12: Top Layer & Silk

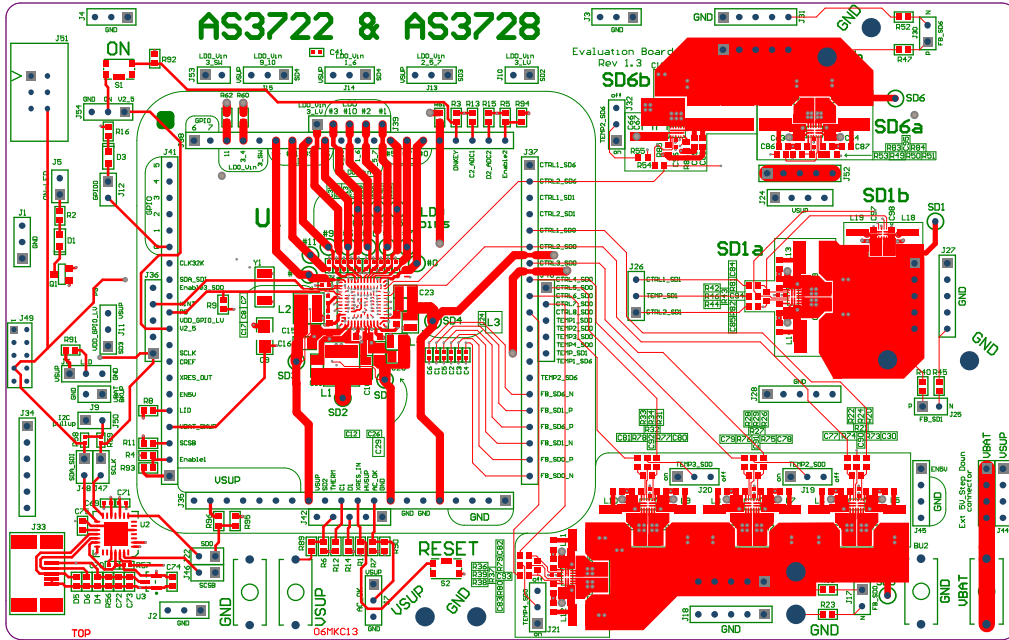

Figure 13: Layer INNER1 - SIGNAL1 & GND

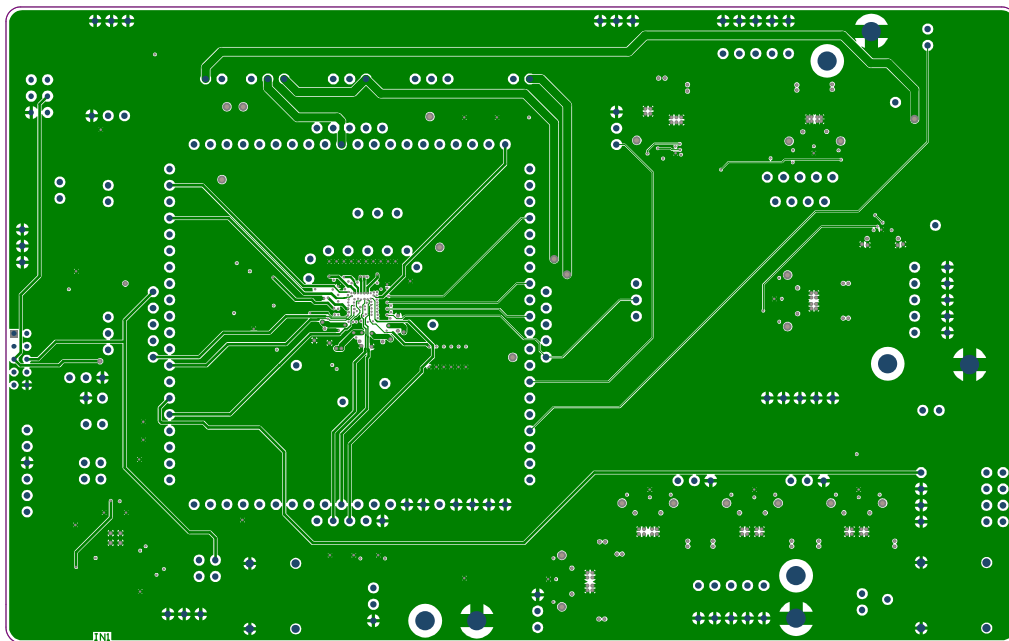

Figure 14: Layer INNER2 - GND

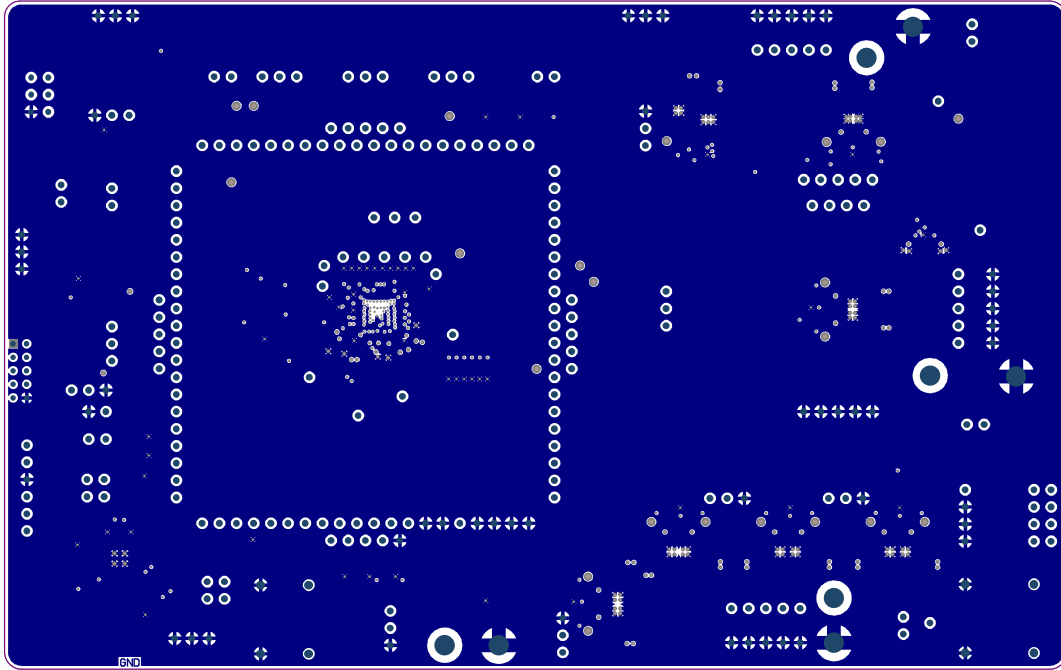

Figure 15: Layer INNER3 - VSUP

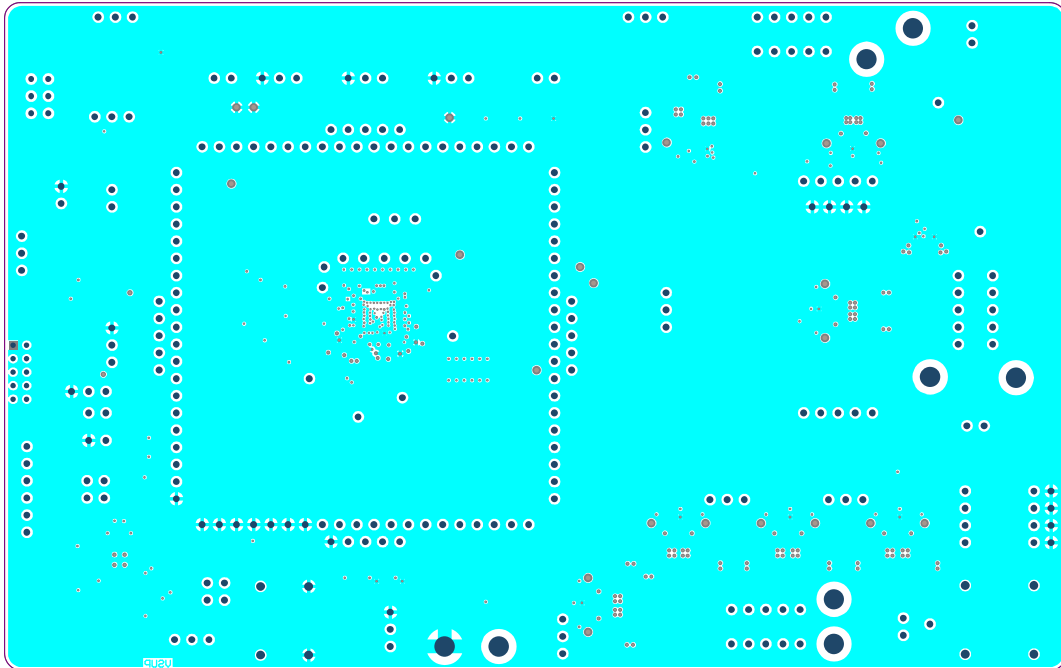

Figure 16: Layer INNER4 - SIGNAL2 & GND

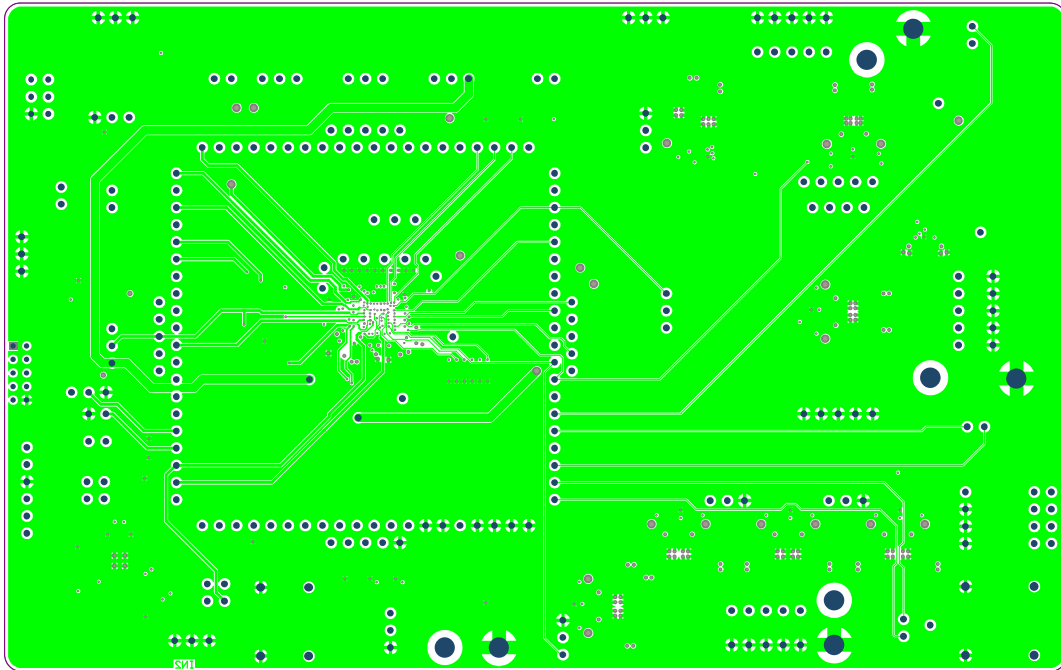
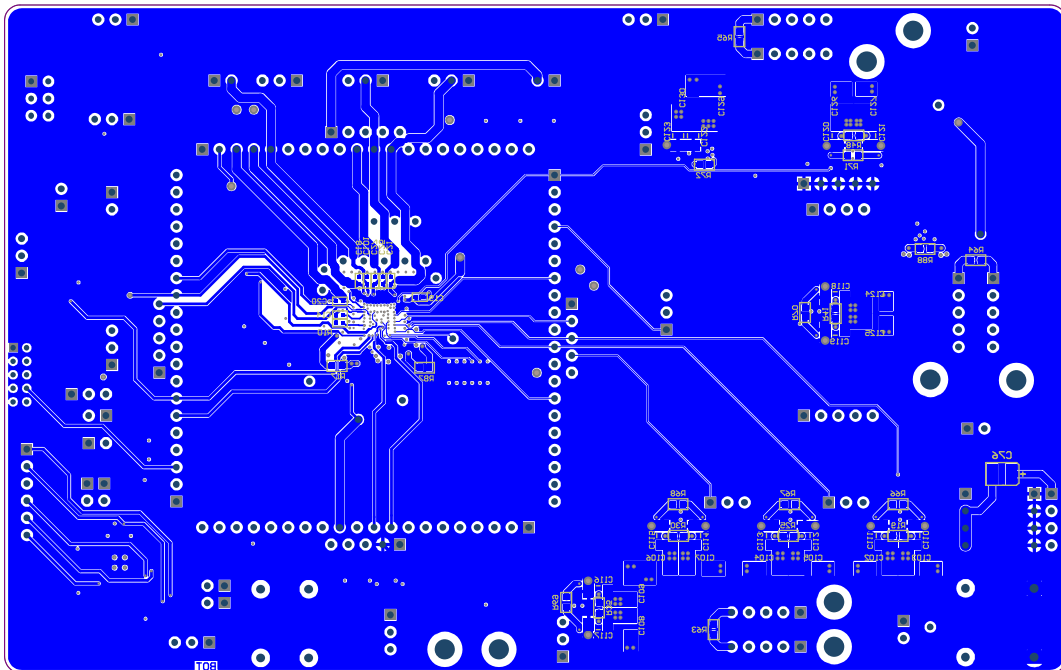

Figure 17: Bottom Layer & Silk



5.3 BOM

Figure 18: Bill of Material

Bill of Materials						amun	
AS3722 Evalboard BGA							
Company:						ams AG	
Originator:						mkc	
PCB Name:						AS3722 Evalboard BGA	
PCB Version:						1.3	
Report Date:						13.08.2014	
#	Designator	Comment	Component_Description	Manufacturer	Manufacturer Part Number	Quantity	
1	BU1, BU11	VBAT, V SUP	HRSCHMANN TEST AND MEASUREMENT - MPB1 RED - MINI-PRUEFBUCHSE ROT	HRSCHMANN TEST AND MEASUREMENT	MPB1 RED	2	
2	BU2, BU12	GND	HRSCHMANN TEST AND MEASUREMENT - MPB1 BLACK - MINI-PRUEFBUCHSE SW	HRSCHMANN TEST AND MEASUREMENT	MPB1 BLACK	2	
3	C1, C2, C3, C4, C5, C6	100p	MURATA - GRM1555C1H101J0D1D - KONDENSATOR, 0402, 100PF, 50V	MURATA	GRM1555C1H101J0D1D	6	
4	C7, C13, C14, C18, C19, C20, C21, C25, C27, C31, C32, C33, C34, C35, C36, C37, C38, C39, C40, C41, C50, C91, C92, C93, C94, C95, C96, C101	1u	MURATA - GRM155R81A105KE15D - KONDENSATOR, 0402, 1.0UF, 10V	MURATA	GRM155R81A105KE15D	28	
5	C8, C89, C70, C71	100n	MURATA - GRM155R71A104KA01D - CAPACITOR, 0402, X7R, 10V, 100NF	MURATA	GRM155R71A104KA01D	4	
6	C9	100u	MURATA - GRM01CR60J107ME9L - KONDENSATOR, 1206, 100UF, 6.3V	MURATA	GRM01CR60J107ME9L	1	
7	C10, C11, C15, C22, C28	22u	CAP CER 22UF 6.3V 20% X5R 0805	Taiyo Yuden	JMK212B1J22M-D-T	5	
8	C12, C17, C24, C26	2u2	CAP CER 2.2UF 10V 10% X7R 0603	Murata Electronics North America	GRM188R71A225KE15D	4	
9	C30, C77, C78, C79, C80, C81, C82, C83, C84, C85, C86, C87, C88, C89	100n	CAP CER 0.1UF 16V 10% X7R 0603	Murata Electronics North America	GRM188R71C104KA01D	14	
10	C42, C45, C48, C49, C50, C53, C54, C57, C58, C61, C62, C65, C68, C103, C105, C107, C109, C124, C127, C128, C129	47u	CAP CER 47UF 6.3V 20% X5R 0805	Taiyo Yuden	JMK212B1J47M63-T	21	
11	C43, C44, C47, C48, C51, C52, C55, C56, C59, C60, C63, C64, C66, C67, C110, C111, C112, C113, C114, C115, C116, C117, C118, C119, C120, C121, C122, C123	10u	CAP CER 10UF 25V 10% X5R 1206	Taiyo Yuden	TMK316ABJ106KD-T	28	
12	C72	100nF	MURATA - GRM188R71E104KA01D - CAPACITOR, 0603, X7R, 25V, 100NF	MURATA	GRM188R71E104KA01D	1	
13	C73, C74	1uF	MURATA - GRM188R71E105KA12D - KONDENSATOR, 0603, 1.0UF, 25V	MURATA	GRM188R71E105KA12D	2	
14	C75	10u	MURATA - GRM188R60J106ME47D - KONDENSATOR, 0603, 10UF, 6.3V	MURATA	GRM188R60J106ME47D	1	
15	C76	100uF	AVX - TPSB107M10R0400 - KONDENSATOR, BAUF, B, 100 UF, 10V	AVX	TPSB107M10R0400	1	
16	D1, D3	LED	AVAGO TECHNOLOGIES - HSMW-C191 - LED, SMD WEISS	AVAGO TECHNOLOGIES	HSMW-C191	2	
17	D4, D5, D6	ESD	COOPER BUSSMANN - 0603ESDA-TR1 - DIODE TVS, BL24V, 0603	COOPER BUSSMANN	0603ESDA-TR1	3	
18	J1, J2, J3, J5, J9, J10, J11, J12, J13, J14, J15, J16, J17, J18, J19, J20, J21, J23, J25, J27, J29, J30, J31, J32, J35, J36, J37, J38, J39, J40, J41, J42, J43, J44, J45, J47, J48, J50, J53	Jumper_THMD	FISCHER ELEKTRONIK - SL11 124 36G - STIFTLISTE, 36POL, 2.54MM RASTER	FISCHER ELEKTRONIK	SL11 124 36G	39	
19	J6, J7, J54	LID, AC, OK, ONKEY	FISCHER ELEKTRONIK - SL11 124 36G - STIFTLISTE, 36POL, 2.54MM RASTER	FISCHER ELEKTRONIK	SL11 124 36G	3	
20	J33	USB_AB_MIN_SMD_MOLEX	MOLEX - 548190572 - BUCHSE USB, MINI-B, SMT	MOLEX	548190572	1	
21	L1, L2	0.47u	INDUCTOR POWER 070M 420% SMD	TDK Corporation	SPW01ST-047M	2	
22	L3, L4	1u	INDUCTOR 1.0UH 20% 1008	TDK	TFM252010GH4-1R0MTAA	2	
23	L5, L6, L7, L8, L9, L10, L11, L12, L13, L14, L15, L16, L17, L20	0.68u	INDUCTOR POWER 0804H SMD	TDK	SPW01ST-R68	14	
24	Q1	SI1304	VISHAY SILICONIX - SI1304BDL-T1-E3 - N CHANNEL MOSFET, 30V, 900mA, SC-70	VISHAY SILICONIX	SI1304BDL-T1-E3	1	
25	R1, R3, R5, R6, R7, R8, R11, R12, R13, R14, R15, R93, R95	1M	BOURNS - CR0603-JW-105GLF - WIDERSTAND, 0603, 1M5%, 0.1W	BOURNS	CR0603-JW-105GLF	13	
26	R2	1k	BOURNS - CR0603-JW-102GLF - WIDERSTAND, 0603, 1K5%, 0.1W	BOURNS	CR0603-JW-102GLF	1	
27	R9, R56	100k	BOURNS - CR0603-FX-1003ELF - WIDERSTAND, 0603, 100K, 1%, 0.1W	BOURNS	CR0603-FX-1003ELF	2	
28	R10	220k	MULTICOMP - MC 0.0625W 0402 1% 220K - WIDERSTAND, 0402 1% 220K	MULTICOMP	MC 0.0625W 0402 1% 220K	1	
29	R16	270	VISHAY DRALORIC - CRCW0603270RFKEAHP - WIDERSTAND, 0603, 1%, 270R	VISHAY DRALORIC	CRCW0603270RFKEAHP	1	
30	R18, R20, R22, R23, R24, R26, R28, R29, R31, R33, R34, R36, R38, R39, R40, R42, R44, R45, R46, R47, R48, R49, R50, R52, R53, R54, R55, R60, R61, R62, R73, R74, R75, R76, R77, R78, R79, R80, R81, R82, R83, R84, R85, R86	0R	VISHAY DRALORIC - CRCW0603000020EA - RESISTOR, 0603, 0R, 0.1W, ±1%	VISHAY DRALORIC	CRCW0603000020EA	44	
31	R57	10k	VISHAY DRALORIC - CRCW040210K0FKEAHP - WIDERSTAND, 0402, 1%, 10K0	VISHAY DRALORIC	CRCW040210K0FKEAHP	1	
32	R58, R59	8k2	VISHAY DRALORIC - CRCW04028K20FKEAHP - WIDERSTAND, 0402, 1%, 8K20	VISHAY DRALORIC	CRCW04028K20FKEAHP	2	
33	R63	20k	MULTICOMP - MC 0.063W 0603 1% 20K - WIDERSTAND, 0603 20K	MULTICOMP	MC 0.063W 0603 1% 20K	1	
34	R64	82k	MULTICOMP - MC 0.063W 0603 1% 82K - WIDERSTAND, 0603 82K	MULTICOMP	MC 0.063W 0603 1% 82K	1	
35	R65	39k	MULTICOMP - MC0063W0603139K - WIDERSTAND, 0603 39K	MULTICOMP	MC0063W0603139K	1	
36	S1, S2	ON, Reset	SWITCH TACTILE SPST-NO 0.05A 32V	C&K Components	KMR211GLFS	2	
37	SD0a, SD0b, SD0c, SD0d, SD1a, SD0a, SD0b	AS3722	VERO - 20-313137 - LOTSTUTZPUNKT ROT BIS MAX. 475° 100ST	VERO	AS3722-BWLT	7	
38	TP1, TP2, TP3, TP4, TP5, TP6, TP7, TP8, TP9, TP10, TP11, TP12, TP13, TP14, TP15, TP16, TP17, TP18, TP19, TP20					16	
39	U1	AS3722			AS3722-BCTT-00	1	
40	U2	PC24FJ64GB002	MICROCHIP - PC24FJ64GB002-IML - MCU 16BIT, 64K FLASH, USB, OTG, 280FN	MICROCHIP	PC24FJ64GB002-IML	1	
41	U3	AS1360	FLDIO 150MA 3.3V SOT23-3	ams AG	AS1360-33-T	1	
42	Y1	CRYSTAL	CRYSTAL 32.768KHZ 7PF SMD	Citizen Finetech Myota	CM519-32.768KD2YT	1	
Approved						Notes	
						286	

Note: Populated components may vary!

6 Ordering & Contact Information

The AS3722 Evaluation Kit can be ordered via www.ams.com.

Ordering Code	Description
AS3722-CT-00_EK_ST AS3728	AS3722 Eval Kit Standard Board

Buy our products or get free samples online at:

www.ams.com/ICdirect

Technical Support is available at:

www.ams.com/Technical-Support

Provide feedback about this document at:

www.ams.com/Document-Feedback

For further information and requests, e-mail us at:

ams_sales@ams.com

For sales offices, distributors and representatives, please visit:

www.ams.com/contact

Headquarters

ams AG

Tobelbaderstrasse 30

8141 Unterpremstaetten

Austria, Europe

Tel: +43 (0) 3136 500 0

Website: www.ams.com

7 Copyrights & Disclaimer

Copyright ams AG, Tobelbader Strasse 30, 8141 Unterpemstaetten, Austria-Europe. Trademarks Registered. All rights reserved. The material herein may not be reproduced, adapted, merged, translated, stored, or used without the prior written consent of the copyright owner.

Demo Kits, Evaluation Kits and Reference Designs are provided to recipient on an “as is” basis for demonstration and evaluation purposes only and are not considered to be finished end-products intended and fit for general consumer use, commercial applications and applications with special requirements such as but not limited to medical equipment or automotive applications. Demo Kits, Evaluation Kits and Reference Designs have not been tested for compliance with electromagnetic compatibility (EMC) standards and directives, unless otherwise specified. Demo Kits, Evaluation Kits and Reference Designs shall be used by qualified personnel only.

ams AG reserves the right to change functionality and price of Demo Kits, Evaluation Kits and Reference Designs at any time and without notice.

Any express or implied warranties, including, but not limited to the implied warranties of merchantability and fitness for a particular purpose are disclaimed. Any claims and demands and any direct, indirect, incidental, special, exemplary or consequential damages arising from the inadequacy of the provided Demo Kits, Evaluation Kits and Reference Designs or incurred losses of any kind (e.g. loss of use, data or profits or business interruption however caused) as a consequence of their use are excluded.

ams AG shall not be liable to recipient or any third party for any damages, including but not limited to personal injury, property damage, loss of profits, loss of use, interruption of business or indirect, special, incidental or consequential damages, of any kind, in connection with or arising out of the furnishing, performance or use of the technical data herein. No obligation or liability to recipient or any third party shall arise or flow out of ams AG rendering of technical or other services.

8 Revision Information

Initial version 1-00

X-ON Electronics

Largest Supplier of Electrical and Electronic Components

Click to view similar products for [Power Management IC Development Tools](#) category:

Click to view products by [ams](#) manufacturer:

Other Similar products are found below :

[EVAL-ADM1168LQEBZ](#) [EVB-EP5348UI](#) [MIC23451-AAAYFL EV](#) [MIC5281YMME EV](#) [DA9063-EVAL](#) [ADP122-3.3-EVALZ](#) [ADP130-0.8-EVALZ](#) [ADP130-1.2-EVALZ](#) [ADP130-1.5-EVALZ](#) [ADP130-1.8-EVALZ](#) [ADP1714-3.3-EVALZ](#) [ADP1716-2.5-EVALZ](#) [ADP1740-1.5-EVALZ](#) [ADP1752-1.5-EVALZ](#) [ADP1828LC-EVALZ](#) [ADP1870-0.3-EVALZ](#) [ADP1871-0.6-EVALZ](#) [ADP1873-0.6-EVALZ](#) [ADP1874-0.3-EVALZ](#) [ADP1882-1.0-EVALZ](#) [ADP199CB-EVALZ](#) [ADP2102-1.25-EVALZ](#) [ADP2102-1.875EVALZ](#) [ADP2102-1.8-EVALZ](#) [ADP2102-2-EVALZ](#) [ADP2102-3-EVALZ](#) [ADP2102-4-EVALZ](#) [ADP2106-1.8-EVALZ](#) [ADP2147CB-110EVALZ](#) [AS3606-DB](#) [BQ24010EVM](#) [BQ24075TEVM](#) [BQ24155EVM](#) [BQ24157EVM-697](#) [BQ24160EVM-742](#) [BQ24296MEVM-655](#) [BQ25010EVM](#) [BQ3055EVM](#) [NCV891330PD50GEVB](#) [ISLUSBI2CKIT1Z](#) [LM2744EVAL](#) [LM2854EVAL](#) [LM3658SD-AEV/NOPB](#) [LM3658SDEV/NOPB](#) [LM3691TL-1.8EV/NOPB](#) [LM4510SDEV/NOPB](#) [LM5033SD-EVAL](#) [LP38512TS-1.8EV](#) [EVAL-ADM1186-1MBZ](#) [EVAL-ADM1186-2MBZ](#)