



**high
performance
needs great
design.**

Datasheet: AS5262 12-Bit Magnetic Angle Position Sensor

Please be patient while we update our brand image as austriamicrosystems and TAOS are now ams.

AS5262

12-Bit Magnetic Angle Position Sensor

1 General Description

The AS5262 is a contactless magnetic angle position sensor for accurate angular measurement over a full turn of 360°. A sub range can be programmed to achieve the best resolution for the application. It is a system-on-chip, combining integrated Hall elements, analog front end, digital signal processing and best in class automotive protection features in a single device.

To measure the angle, only a simple two-pole magnet, rotating over the center of the chip, is required. The magnet may be placed above or below the IC.

The absolute angle measurement provides instant indication of the magnet's angular position with a resolution of $0.022^\circ = 16384$ positions per revolution. According to this resolution the adjustment of the application specific mechanical positions are possible. The angular output data is available over a 12 bit ratiometric analog output.

The AS5262 operates at a supply voltage of 5V and the supply and output pins are protected against overvoltage up to +20V. In addition the supply pins are protected against reverse polarity up to -20V.

Figure 1. Typical Arrangement of AS5262 and magnet

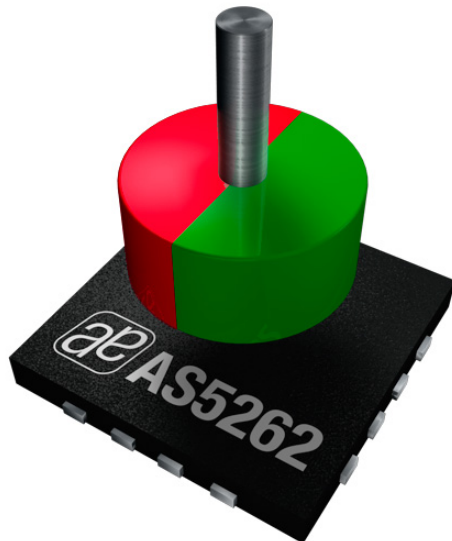

2 Key Features

- 360° contactless high resolution angular position sensing
- User programmable start and end point of the application region + linearization.
- User programmable clamping levels and programming of the transition point.
- Powerful analog output
 - Short circuit monitor
 - High driving capability for resistive and capacitive loads
- Wide temperature range: - 40°C to + 150°C
- Small Pb-free package: MLF 16 6x6 (with dimple)
- Broken GND and VDD detection over a wide range of different load conditions.
- Saw tooth mode 1,2,3,4 slopes per revolution

3 Benefits

- Unique fully differential patented solution
- Best protections for automotive applications
- Easy to program
- Additional linearization points for output characteristic
- Ideal for applications in harsh environments due to contactless position sensing
- Robust system, tolerant to magnet misalignment, air gap variations, temperature variations and external magnetic fields
- High inherent accuracy
- High driving capability of analog output (including diagnostics)
- Broken GND and VDD detection for all external load cases

4 Applications

The AS5262 is ideal for automotive applications like throttle and valve position sensing, gearbox position sensor, tumble flap, chassis height level, pedal position sensing and contactless potentiometers.



Figure 2. AS5262 Block Diagram

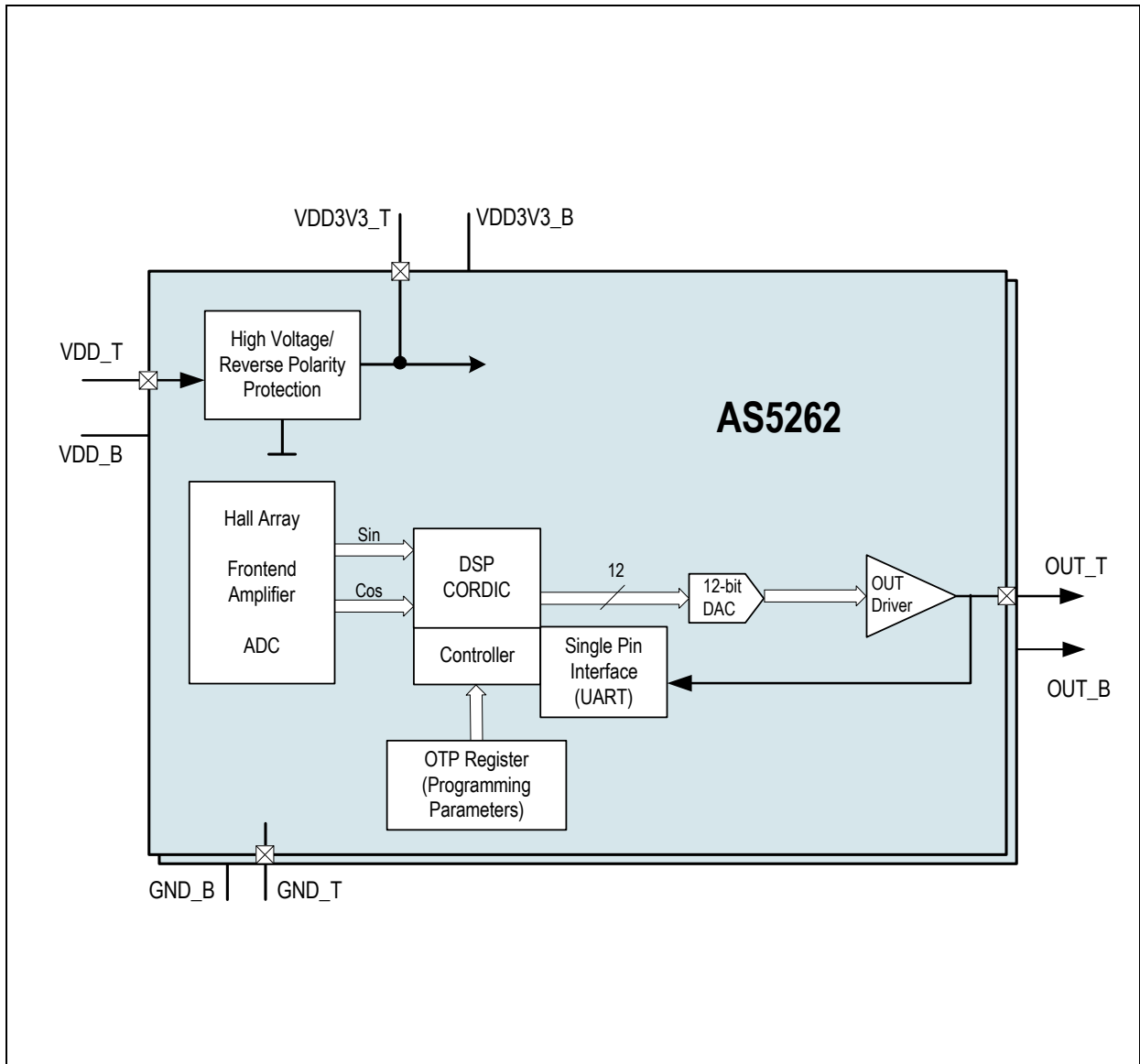



Contents

1	General Description	1
2	Key Features.....	1
3	Benefits	1
4	Applications.....	1
5	Pin Assignments	4
5.1	Pin Descriptions.....	4
6	Absolute Maximum Ratings	5
7	Electrical Characteristics.....	6
7.1	Operating Conditions.....	6
7.2	Magnetic Input Specification.....	6
7.3	Electrical System Specifications.....	7
7.4	Timing Characteristics	8
7.5	Power Management - Supply Monitor	8
8	Detailed Description.....	9
8.1	Operation.....	9
8.1.1	VDD Voltage Monitor	9
8.2	Analog Output.....	9
8.2.1	Programming Parameters.....	10
8.2.2	Application Specific Angular Range Programming	10
8.2.3	Application Specific Programming of the Break Point	11
8.2.4	Full Scale Mode	11
8.2.5	Multiple Slope Output	12
8.2.6	Linearization of the Output.....	13
8.2.7	Resolution of Parameters	13
8.2.8	Analog Output Diagnostic Mode	15
8.2.9	Analog Output Driver Parameters.....	15
8.2.10	Noise Suppressor	16
8.2.11	Hysteresis Function	16
9	Application Information	16
9.1	Recommended Application Schematic.....	16
9.2	Programming the AS5262	18
9.2.1	UART Interface for Programming	18
9.2.2	Frame Organization	18
9.2.3	WRITE (Command Description)	20
9.2.4	READ (Command Description).....	21
9.2.5	Baud-rate Automatic Detection.....	21
9.2.6	Baud-rate Manual Setting (optional)	21
9.3	OTP Programming Data	23
9.4	READ / WRITE Register Map.....	27
9.5	READ Only Register Map.....	28
9.6	Special Registers.....	30
9.7	Programming Procedure	31
10	Package Drawings and Markings	32
11	Ordering Information	35



5 Pin Assignments

Figure 3. MLF-16 Pin Configuration (View from Top)

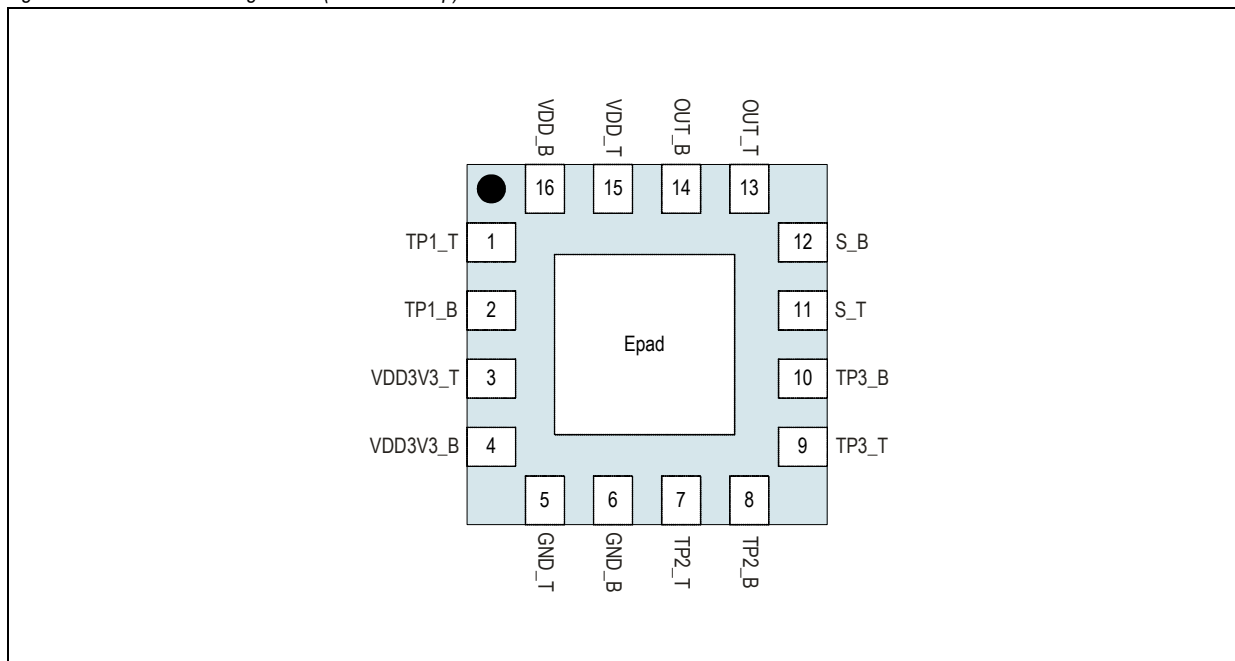

5.1 Pin Descriptions

Table 1. MLF-16 Pin Descriptions

Pin Number	Pin Name	Pin Type	Description
1	TP1_T	DIO/AIO Multi purpose pin	Test pin for fabrication. Connected to ground in the application.
2	TP1_B		Test pin for fabrication. Connected to ground in the application.
3	VDD3V3_T	AIO	Output of the LDO. 1μF required.
4	VDD3V3_B		Output of the LDO. 1μF required.
5	GND_T	Supply pin	Ground pin. Connected to ground in the application.
6	GND_B		Ground pin. Connected to ground in the application.
7	TP2_T	DIO/AIO Multi purpose pin	Test pin for fabrication. Connected to ground in the application.
8	TP2_B		Test pin for fabrication. Connected to ground in the application.
9	TP3_T		Test pin for fabrication. Left open in the application.
10	TP3_B		Test pin for fabrication. Left open in the application.
11	S_T	AIO	Test pin for fabrication. Connected to OUT_T in the application. (special case for the connection possible → 4-wire mode)
12	S_B		Test pin for fabrication. Connected to OUT_B in the application. (special case for the connection possible @ 4-wire mode)
13	OUT_T	Analog output pin	Output pin analog output. Over this pin the programming is possible.
14	OUT_B		Output pin analog output. Over this pin the programming is possible.
15	VDD_T	Supply pin	Positive supply pin. This pin is over voltage protected.
16	VDD_B		Positive supply pin. This pin is over voltage protected.



6 Absolute Maximum Ratings

Stresses beyond those listed in [Table 2](#) may cause permanent damage to the device. These are stress ratings only, and functional operation of the device at these or any other conditions beyond those indicated in [Electrical Characteristics on page 6](#) is not implied. Exposure to absolute maximum rating conditions for extended periods may affect device reliability.

Table 2. Absolute Maximum Ratings

Symbol	Parameter	Min	Max	Units	Comments
Electrical Parameters					
V _{DD}	DC supply voltage at pin VDD Overvoltage	-20	20	V	No operation
V _{OUT}	Output voltage OUT	-0.3	20	V	Permanent
V _{diff}	Voltage difference at pin VDD and OUT	-20	20	V	
V _{DD3V3}	DC supply voltage at pin VDD3V3	-0.3	5	V	
I _{scr}	Input current (latchup immunity)	-100	100	mA	Norm: AEC-Q100-004
Electrostatic Discharge					
ESD	Electrostatic discharge		±2	kV	Norm: AEC-Q100-002
Temperature Ranges and Storage Conditions					
T _{strg}	Storage temperature	-55	+150	°C	Min -67°F; Max +257°F
T _{Body}	Body temperature		260	°C	The reflow peak soldering temperature (body temperature) specified is in accordance with IPC/JEDEC J-STD-020 "Moisture/Reflow Sensitivity Classification for Non-Hermetic Solid State Surface Mount Devices". The lead finish for Pb-free leaded packages is matte tin (100% Sn).
H	Humidity non-condensing	5	85	%	
MSL	Moisture Sensitive Level		3		Represents a maximum floor life time of 168h



7 Electrical Characteristics

7.1 Operating Conditions

In this specification, all the defined tolerances for external components need to be assured over the whole operation conditions range and also over lifetime.

Table 3. Operating Conditions

Symbol	Parameter	Conditions	Min	Typ	Max	Units
T _{AMB}	Ambient temperature		-40		+150	°C
I _{supp}	Supply current	Only for one die. Must be multiplied by 2			12	mA
VDD	Supply voltage at pin VDD		4.5	5.0	5.5	V

7.2 Magnetic Input Specification

T_{AMB} = -40 to +150°C, VDD = 4.5 to 5.5V (5V operation), unless otherwise noted.

Two-pole cylindrical diametrically magnetized source:

Table 4. Magnetic Input Specification

Symbol	Parameter	Conditions	Min	Typ	Max	Units
B _{pk}	Magnetic input field amplitude	Required vertical component of the magnetic field strength on the die's surface, measured along a concentric circle with a radius of 1.25 mm	30		70	mT
B _{pkext}	Magnetic input field amplitude (extended) default setting	Required vertical component of the magnetic field strength on the die's surface, measured along a concentric circle with a radius of 1.25 mm. Increased sensor output noise.	10		90	mT
B _{off}	Magnetic offset	Constant magnetic stray field			± 5	mT
	Field non-linearity	Including offset gradient			5	%
D _{isp}	Displacement radius	Offset between defined device center and magnet axis. Dependent on the selected magnet. Including Eccentricity.		1		mm



7.3 Electrical System Specifications

T_{AMB} = -40 to +150°C, VDD = 4.5 - 5.5V (5V operation), [Magnetic Input Specification](#), unless otherwise noted.

Table 5. Electrical System Specifications

Symbol	Parameter	Conditions	Min	Typ	Max	Units
RES	Resolution Analog Output	Range > 90° 1LSB=1.221mV typ			12	bit
INL _{opt}	Integral non-linearity (optimum)	Best aligned reference magnet at 25°C over full turn 360°.			0.5	deg
INL _{temp}	Integral non-linearity (optimum)	Best aligned reference magnet over temperature -40 -150° over full turn 360°.			0.9	deg
INL	Integral non-linearity	Best aligned reference magnet over temperature -40 -150° over full turn 360° and displacement			1.4	deg
DNL	Differential non-linearity	Monolithic		0.05		deg
ON	Output noise (360° segment)	1 LSB after filter peak/peak rms value		0.2		%/VDD
t _{pwrUp}	Power-up time 0-5V	See Figure 4			10	ms
t _{delay}	System propagation delay absolute output: delay of ADC, DSP and absolute interface	10kOhm, 100 μF RC filter			300	μs

Figure 4. Power-up timing Diagram

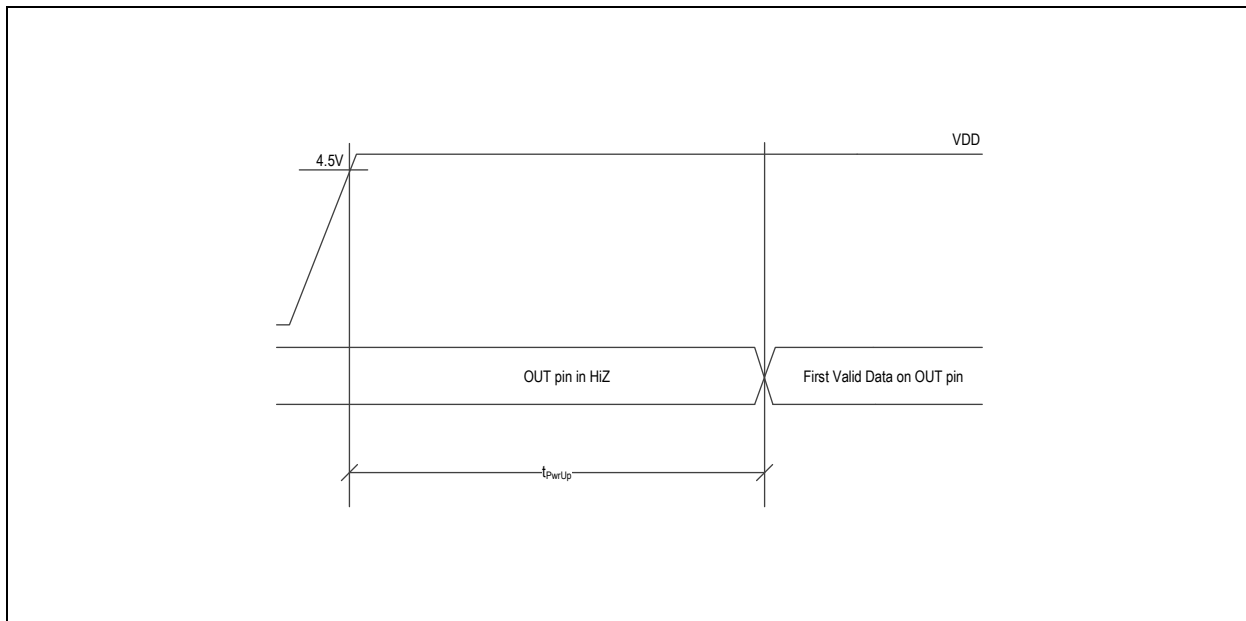



7.4 Timing Characteristics

Table 6. Timing Conditions

Symbol	Parameter	Conditions	Min	Typ	Max	Units
T _{DETWD}	WachDog error detection time				12	ms

7.5 Power Management - Supply Monitor

Table 7. Power Management - Supply Monitor Conditions

Symbol	Parameter	Conditions	Min	Typ	Max	Units
VDD _{UVTH}	VDD undervoltage upper threshold		3.5	4.0	4.5	V
VDD _{UVTL}	VDD undervoltage lower threshold		3.0	3.5	4.0	V
VDD _{UVHYS}	VDD undervoltage hysteresis		300	500	900	mV
VDD _{UVDET}	VDD undervoltage detection time		10	50	250	μs
VDD _{UVREC}	VDD undervoltage recovery time		10	50	250	μs
VDD _{OVTH}	VDD overvoltage upper threshold		6.0	6.5	7.0	V
VDD _{OVTL}	VDD overvoltage lower threshold		5.5	6	6.5	V
VDD _{OVHYS}	VDD overvoltage hysteresis		300	500	900	mV
ANA _{TOVDET}	VDD overvoltage detection time (analog path)		10	50	250	μs
ANA _{TOVREC}	VDD overvoltage recovery time (analog path)		10	50	250	μs



8 Detailed Description

The AS5262 is manufactured in a CMOS process and uses a spinning current Hall technology for sensing the magnetic field distribution across the surface of the chip.

This IC consists of two galvanic isolated dies. All following in and register names refers to one die.

The integrated Hall elements are placed around the center of the device and deliver a voltage representation of the magnetic field at the surface of the IC.

Through Sigma-Delta Analog / Digital Conversion and Digital Signal-Processing (DSP) algorithms, the AS5262 provides accurate high-resolution absolute angular position information. For this purpose a Coordinate Rotation Digital Computer (CORDIC) calculates the angle and the magnitude of the Hall array signals.

The DSP is also used to provide digital information at the outputs that indicate movements of the used magnet towards or away from the device's surface.

A small low cost diametrically magnetized (two-pole) standard magnet provides the angular position information.

The AS5262 senses the orientation of the magnetic field and calculates a 14-bit binary code. This code is mapped to a programmable output characteristic in analog voltage format. This signal is available at the pin (**OUT**).

The application angular region can be programmed in a user friendly way. The start angle position **T1** and the end point **T2** can be set and programmed according the mechanical range of the application with a resolution of 14 bits. In addition the **T1Y** and **T2Y** parameter can be set and programmed according the application. The transition point 0 to 360 degree can be shifted using the break point parameter **BP**. The voltage for clamping level low **CLL** and clamping level high **CLH** can be programmed with a resolution of 9 bits. Both levels are individually adjustable. Two additional linearization points can be used to improve the system linearity. These points **C1** and **C2** are programmable.

The output parameters can be programmed in an OTP register. No additional voltage is required to program the AS5262. The setting may be overwritten at any time and will be reset to default when power is cycled. To make the setting permanent, the OTP register must be programmed by using a lock bit the content could be frozen for ever.

The AS5262 is tolerant to magnet misalignment and unwanted external magnetic fields due to differential measurement technique and Hall sensor conditioning circuitry.

8.1 Operation

8.1.1 VDD Voltage Monitor

VDD Over Voltage Management. If the supply voltage at pin **VDD** exceeds the over-voltage upper threshold for longer than the detection time the output is turned off. When the over voltage event has passed and the voltage applied to pin **VDD** falls below the over-voltage lower threshold for longer than the recovery time the device enters the normal mode and the output is enabled.

VDD Under Voltage Management. When the voltage applied to the **VDD** pin falls below the under-voltage lower threshold for longer than the detection time the output is turned off. When the voltage applied to the **VDD** pin exceeds the under-voltage upper threshold for longer than the detection time the device enters the normal mode and the output is enabled.

8.2 Analog Output

By default (after programmed **CUST_LOCK** OTP bit) the analog output mode is selected. The pin **OUT** provides an analog voltage that is proportional to the angle of the rotating magnet and ratiometric to the supply voltage **VDD**. It can source or sink currents up in normal operation. A short circuit protection is in place and will switch the output driver in high Z in case of an overload event. Due to an intelligent approach a permanent short circuit will not damage the device. This is also feasible in a high voltage condition up to 20 V and at the highest specified ambient temperature.

After the digital signal processing (DSP) a 12-bit Digital-to-Analog converter and output stage provides the output signal.

The DSP maps the application range to the output characteristic. An inversion of the slope is also programmable to allow inversion of the rotation direction.

The reference voltage for the Digital-to-Analog converter (DAC) is taken from **VDD**. In this mode, the output voltage is ratiometric to the supply voltage.

An on-chip diagnostic feature handles the error state at the output. Depending on the failure the output is in HiZ condition or is driven in the failure band. (see Table 9).



8.2.1 Programming Parameters

The analog output characteristic is programmable by OTP. Depending on the application, the analog output can be adjusted. The user can program the following application specific parameters:

T1	Mechanical angle start point
T2	Mechanical angle end point
T1Y	Voltage level at the T1 position
T2Y	Voltage level at the T2 position
CLL	Clamping Level Low
CLH	Clamping Level High
BP	Break point (transition point 0 to 360°)
C1	Calibration Point 1
C2	Calibration Point 2
C1Y	Trim value for C1
C2Y	Trim value for C2

These parameters are input parameters. Using the available programming software and programmer these parameters are converted and finally written into the AS5262 128 bit OTP memory.

8.2.2 Application Specific Angular Range Programming

The application range can be selected by programming T1 with a related T1Y and T2 with a related T2Y into the AS5262. The clamping levels CLL and CLH can be programmed independent from the T1 and T2 position and both levels can be separately adjusted.

Figure 5. Programming of an Individual Application Range

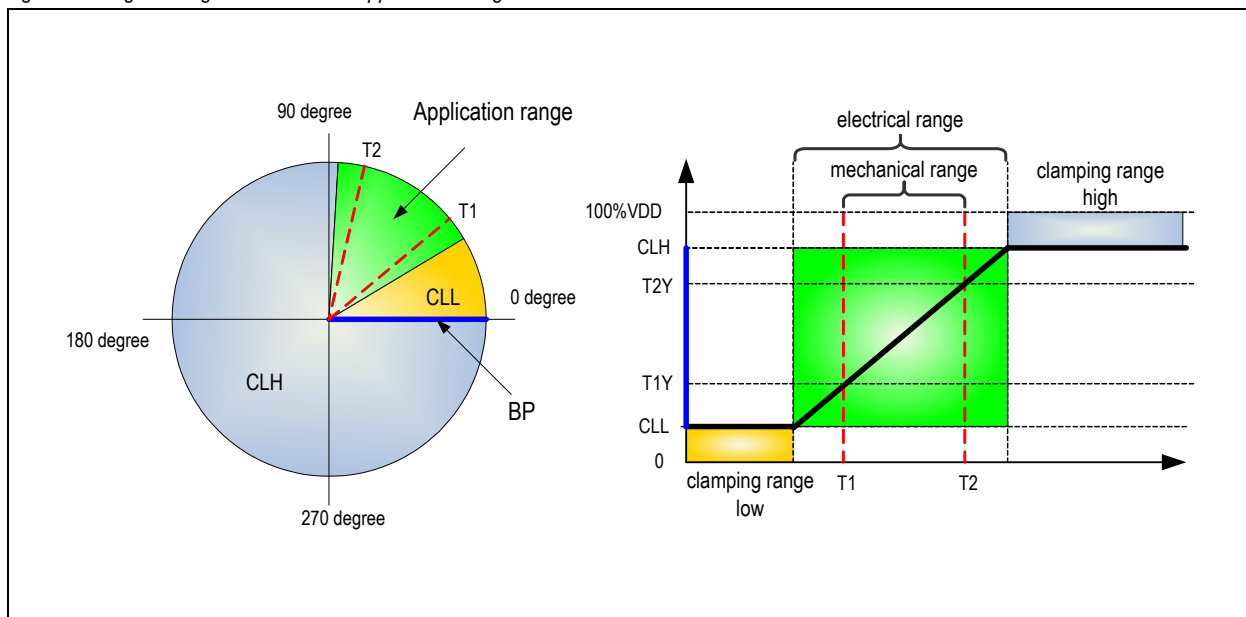

Figure 5 shows a simple example of the selection of the range. The mechanical starting point T1 and the mechanical end point T2 are defining the mechanical range. A sub range of the internal Cordic output range is used and mapped to the needed output characteristic. The analog output signal has 12 bit, hence the level T1Y and T2Y can be adjusted with this resolution. As a result of this level and the calculated slope the clamping region low is defined. The break point BP defines the transition between CLL and CLH. In this example the BP is set to 0 degree. The BP is also the end point of the clamping level high CLH. This range is defined by the level CLH and the calculated slope. Both clamping levels can be set independently from each other.



8.2.3 Application Specific Programming of the Break Point

The break point **BP** can be programmed as well with 14 bits. This is important when the default transition point is inside the application range. In such a case the default transition point must be shifted out of the application range. The parameter **BP** defines the new position.

Figure 6. Individual Programming of the Break Point BP

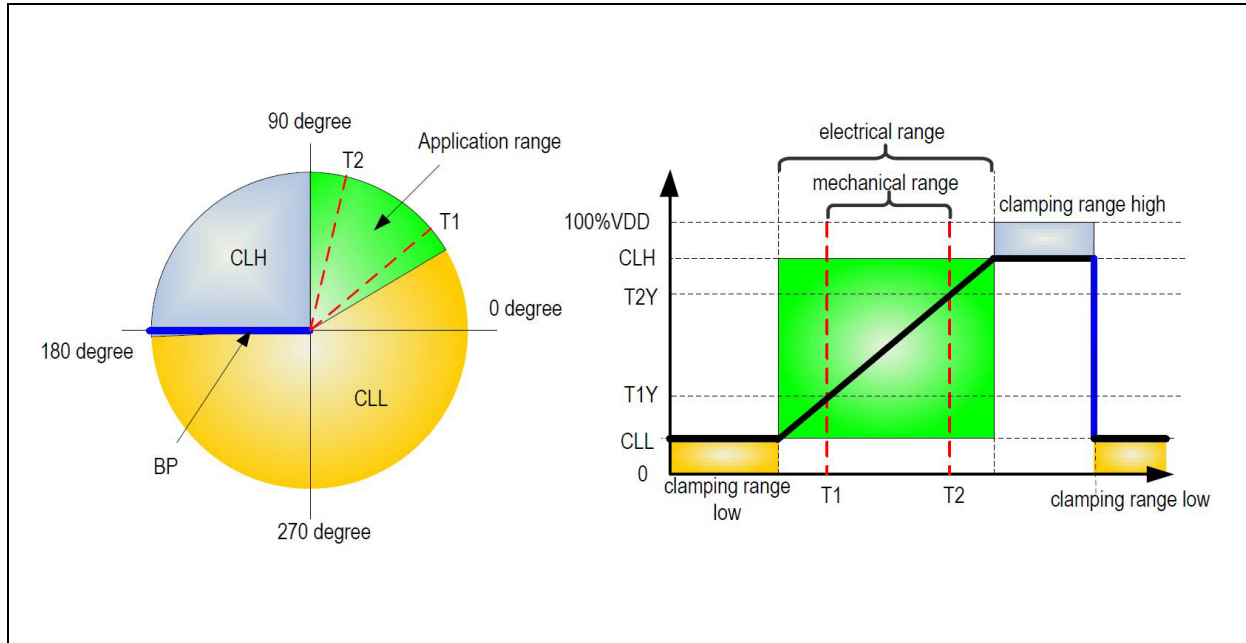

8.2.4 Full Scale Mode

Figure 7. Full Scale Mode

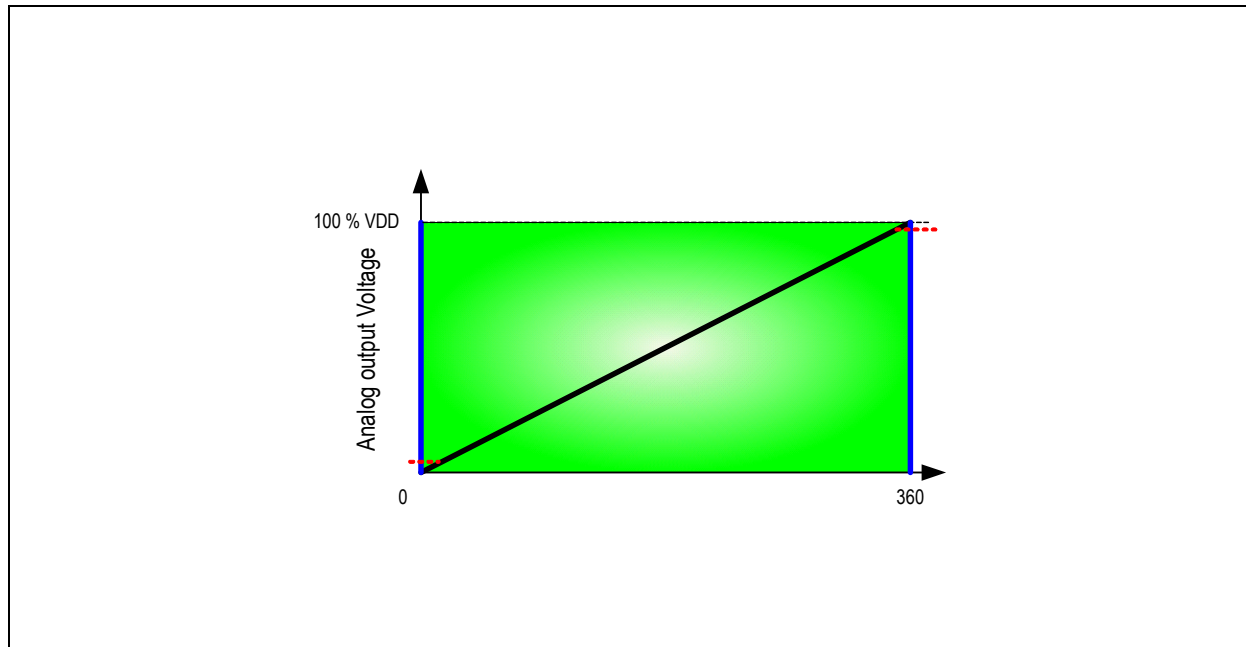

For simplification, Figure 7 describes a linear output voltage from rail to rail (0V to VDD) over the complete rotation range. In practice, this is not feasible due to saturation effects of the output stage transistors. The actual curve will be rounded towards the supply rails (as indicated Figure 7).



8.2.5 Multiple Slope Output

The AS5262 can be programmed to multiple slopes. Where one programmed reference slope characteristic is copied to multiple slopes. Two, three and four slopes are selectable by the user OTP bits QUADEN (1:0). In addition to the steepness of the slope the clamping levels can be programmed as well.

Figure 8. Two Slope Mode

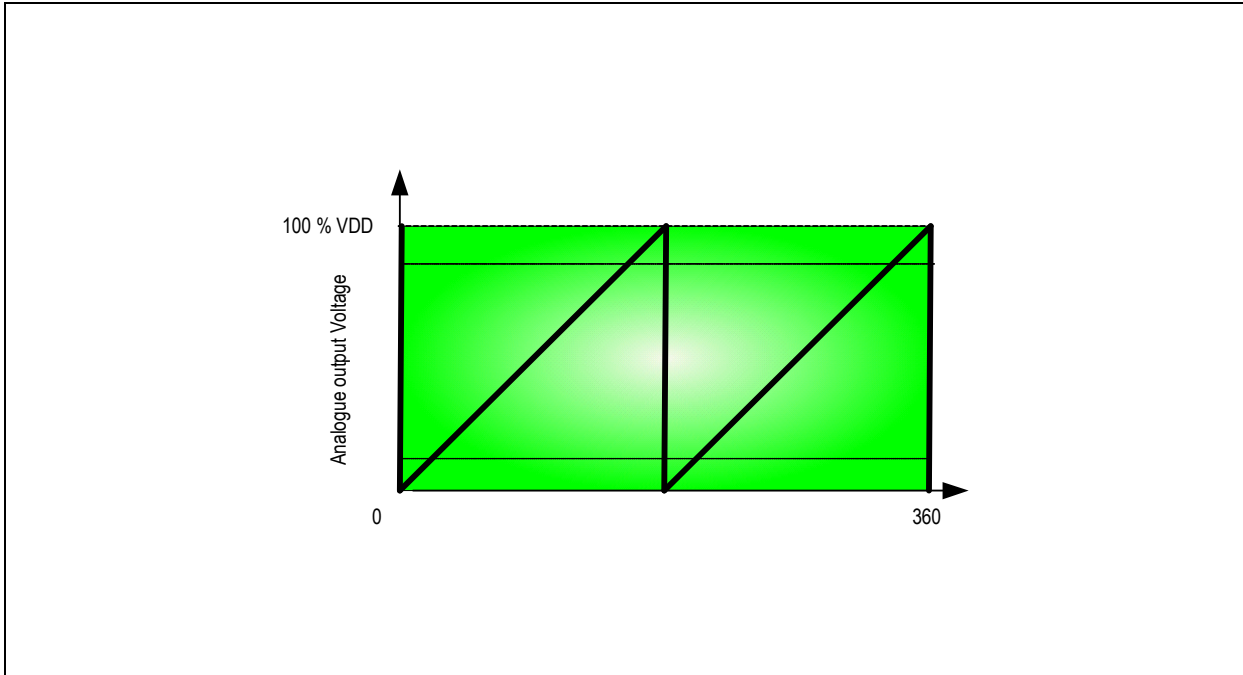
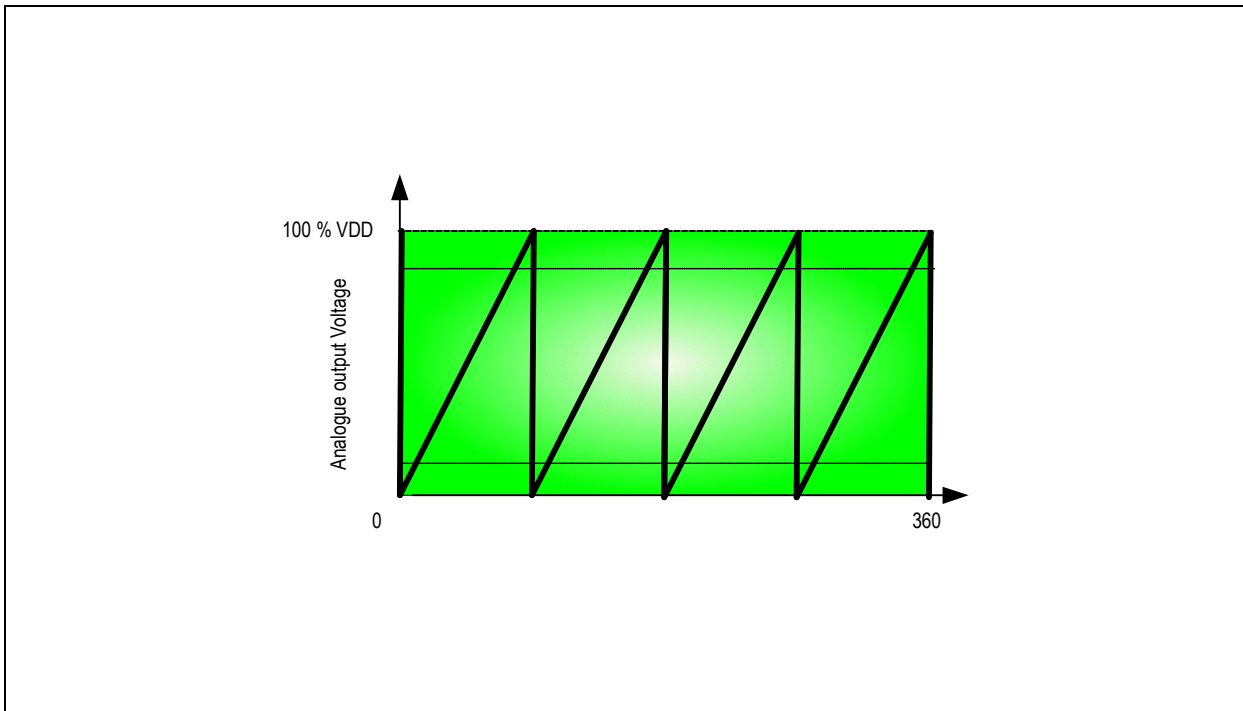

Figure 9. Four Slope Mode





8.2.6 Linearization of the Output

To improve the system linearity an additional 2 point linearization function is implemented in the AS5262.

Figure 10. Linearization of the Output Characteristic

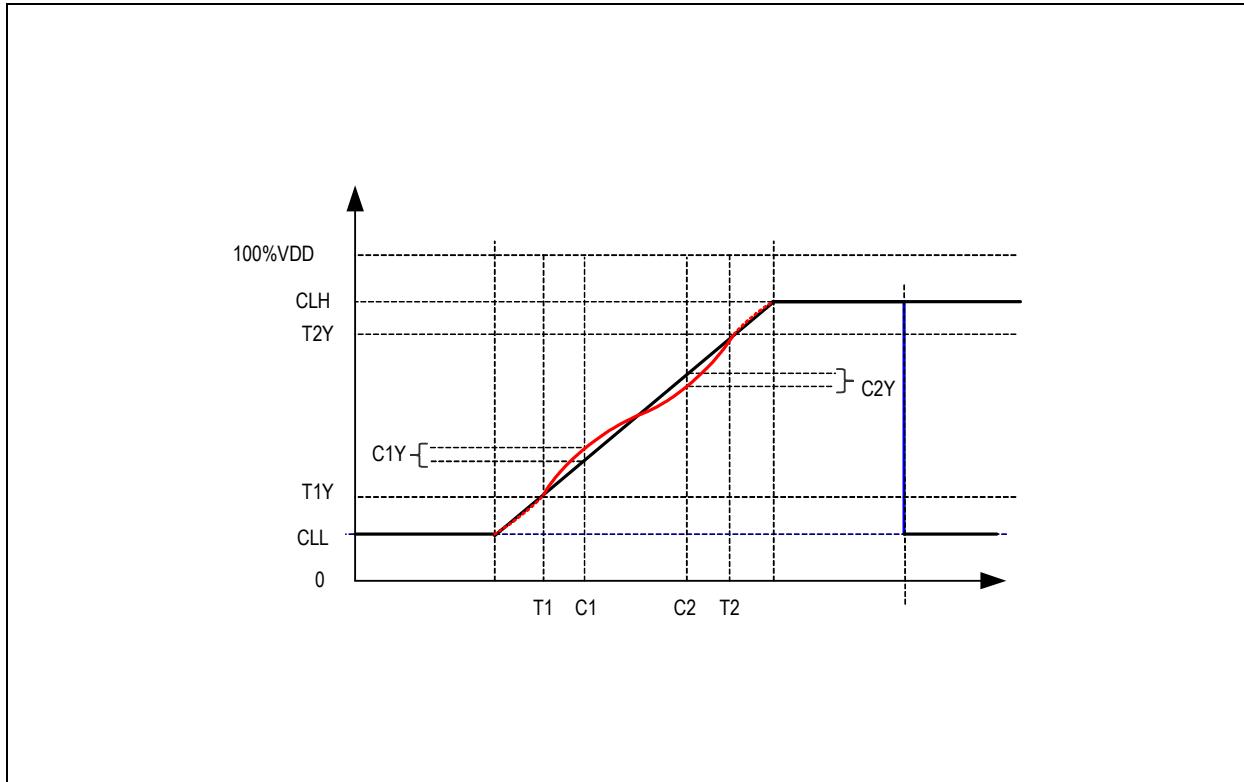

8.2.7 Resolution of Parameters

The programming parameters have a wide resolution of up to 14 bits.

Table 8. Resolution of the Programming Parameters

Symbol	Parameter	Resolution	Note
T1	Mechanical angle start point	14 bits	
T2	Mechanical angle stop point	14 bits	
T1Y	Mechanical start voltage level	12 bits	
T2Y	Mechanical stop voltage level	12 bits	
CLL	Clamping level low	9 bits	
CLH	Clamping level high	9 bits	
BP	Break point	14 bits	
C1	Calibration Point 1	4 bits	
C2	Calibration Point 2	4 bits	
C1Y	Trim value C1	3 bits	
C2Y	Trim value C2	3 bits	



Figure 11. Overview of the Angular Output Voltage

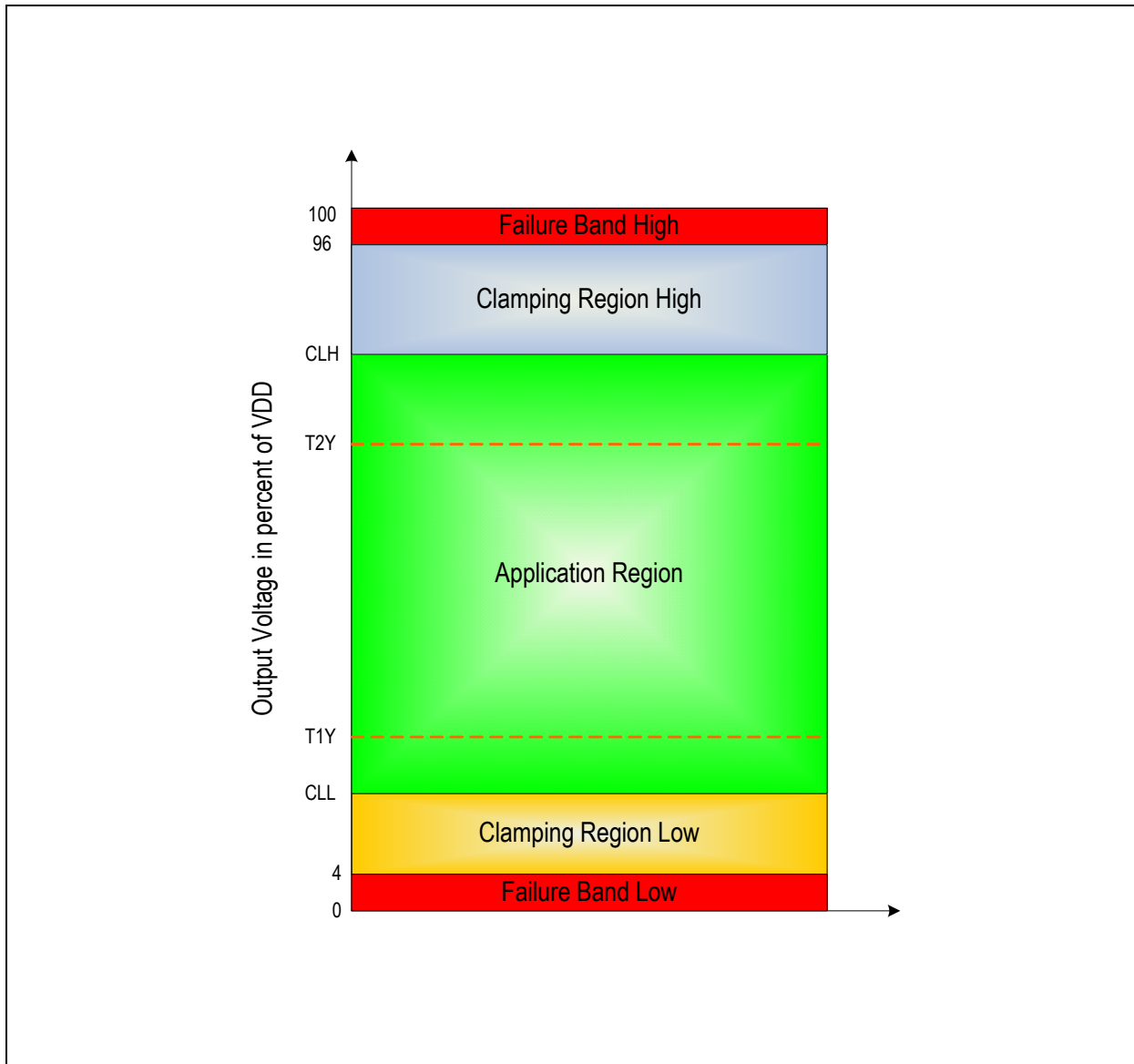

Figure 11 gives an overview of the different ranges. The failure bands are used to indicate a wrong operation of the AS5262. This can be caused due to a broken supply line. By using the specified load resistors, the output level will remain in these bands during a fail. It is recommended to set the clamping level **CLL** above the lower failure band and the clamping level **CLH** below the higher failure band.



8.2.8 Analog Output Diagnostic Mode

Due to the low pin count in the application a wrong operation must be indicated by the output pin **OUT**. This could be realized using the failure bands. The failure band is defined with a fixed level. The failure band low is specified from 0 to 4% of the supply range over the total operation range. The failure band high is defined always from 96 to 100%. Several failures can happen during operation. The output signal remains in these bands over the specified operating and load conditions. All different failures can be grouped into the internal alarms (failures) and the application related failures.

$$C_{LOAD} \leq 33 \text{ nF}, R_{PU} = 4k \dots 10k\Omega$$

$$R_{PD} = 4k \dots 10k\Omega \text{ load pull-up}$$

Table 9. Different Failure Cases of AS5262

Type	Failure Mode	Symbol	Failure Band	Note
Internal alarms (failures)	Out of magnetic range (too less or too high magnetic input)	MAGRng	High/Low	Programmable by OTP bit DIAG_HIGH
	Cordic overflow	COF	High/Low	Programmable by OTP bit DIAG_HIGH
	Offset compensation finished	OCF	High/Low	Programmable by OTP bit DIAG_HIGH
	Watchdog fail	WDF	High/Low	Programmable by OTP bit DIAG_HIGH
	Oscillator fail	OF	High/Low	Programmable by OTP bit DIAG_HIGH
Application related failures	Overvoltage condition	OV	High/Low	Dependant on the load resistor Pull up → failure band high Pull down → failure band low
	Broken VDD	BVDD		
	Broken VSS	BVSS		
	Short circuit output	SCO	High/Low	Switch off → short circuit dependent

For efficient use of diagnostics, it is recommended to program to clamping levels **CLL** and **CLH**.

8.2.9 Analog Output Driver Parameters

The output stage is configured in a push-pull output. Therefore it is possible to sink and source currents.

$$C_{LOAD} \leq 33 \text{ nF}, R_{PU} = 4k \dots 10k\Omega ; R_{PD} = 4k \dots 10k\Omega \text{ load pull-up}$$

Table 10. General Parameters for the Output Driver

Symbol	Parameter	Min	Typ	Max	Unit	Note
IOUTSCL	Short circuit output current (low side driver)	5	10	20	mA	$V_{OUT}=20V$
IOUTSCH	Short circuit output current (high side driver)	-20	-10	-5	mA	$V_{OUT}=0V$
TSCDET	Short circuit detection time	20		600	μs	output stage turned off
TSCREC	Short circuit recovery time	2		20	ms	output stage turned on
ILEAKOUT	Output Leakage current	-20		20	μA	$V_{OUT}=V_{DD}=5V$
BGNDDPU	Output voltage broken GND with pull-up	96		100	%VDD	
BGNDDPD	Output voltage broken GND with pull-down	0		4	%VDD	
BVDDPU	Output voltage broken VDD with pull-up	96		100	%VDD	
BVDDPD	Output voltage broken VDD with pull-down	0		4	%VDD	
OUTRATIO	Output ratiometric error	-0.5		0.5	%VDD	
OUTDNL	Output DNL			$10^{(1)}$	LSB	Between 4% and 96% of VDD
OUTINL	Output INL	$-10^{(2)}$		$10^{(2)}$	LSB	Between 4% and 96% of VDD

Notes:

1. This parameter will be finally defined after temperature characterisation.
2. Design target for this value is reduced.



8.2.10 Noise Suppressor

The noise suppressor is inserted after the angle calculation (first stage) and after range expansion (second stage). This function is capable to reduce the noise level down to 1 LSB peak to peak over different programming ranges.

4 possible configurations of the noise suppressor can be selected via the OTP bits **FILTERCFG<1:0>**.

8.2.11 Hysteresis Function

AS5262 device includes a hysteresis function to avoid sudden jumps from CLH to CLL and vice versa caused by noise in the full turn configuration.

The hysteresis amplitude can be selected via the OTP bits **HYSTSEL<1:0>**.

9 Application Information

9.1 Recommended Application Schematic

Figure 12 shows the recommended schematic in the application. All components marked with (*) are optional and can be used to further increase the EMC.

Figure 12. AS5262 6-Wire Connection with Pull-Down / Pull-Up Resistors

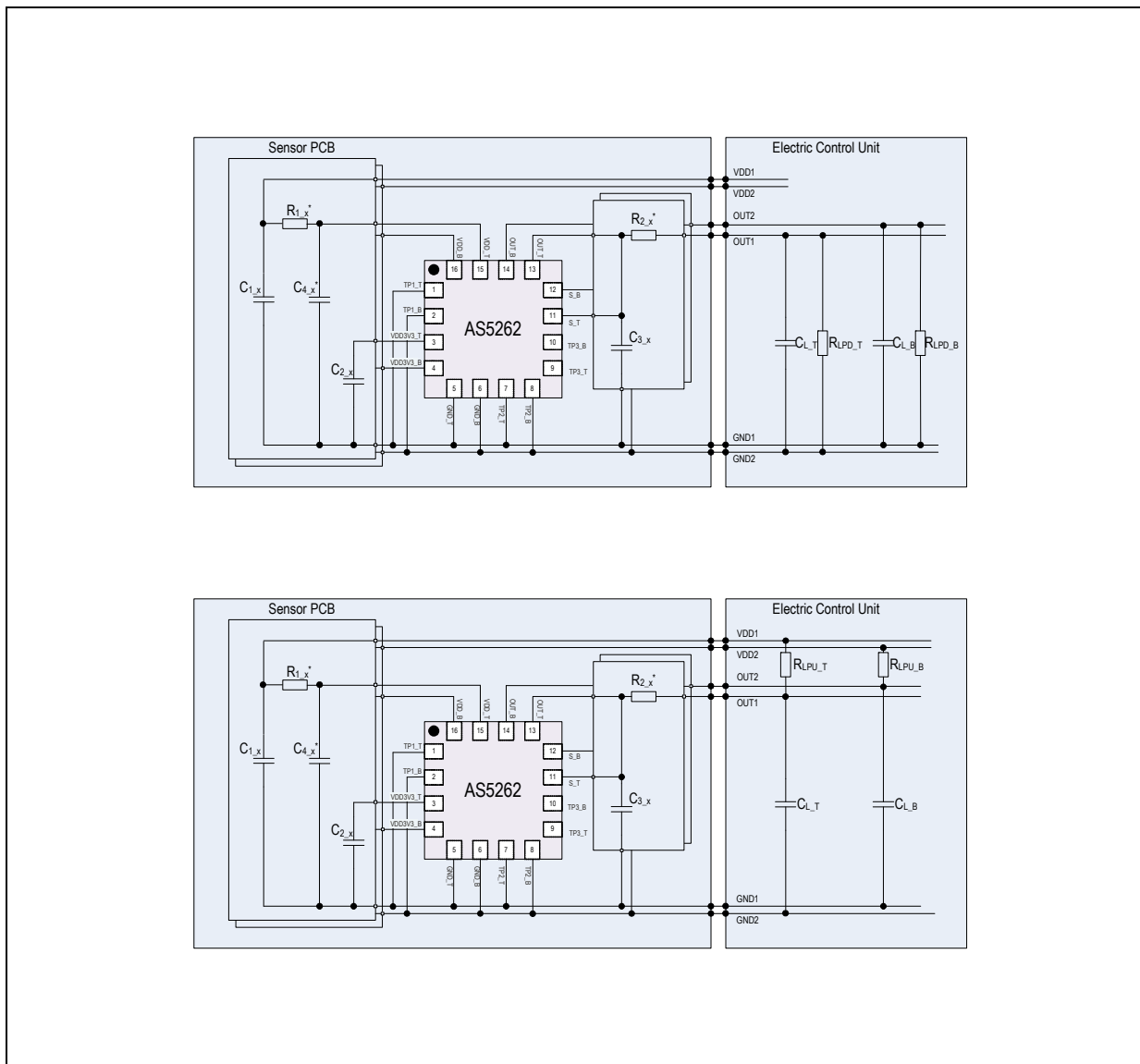



Table 11. External Components

Symbol	Parameter	Min	Typ	Max	Unit	Note
C ₁	VDD buffer capacitor	0.8	1	1.2	μF	Low ESR 0.3 Ω
C ₂	VDD3V3 regulator capacitor	0.8	1	1.2	μF	Low ESR 0.3 Ω
C ₃	OUT load capacitor (sensor PCB)	0		4.7	nF	
C ₄ [*]	VDD capacitor (optional)		4.7		nF	Do not increase due to programming over output.
R ₁ [*]	VDD serial resistor (optional)		10		Ω	
C _L	OUT load capacitor (ECU)	0		33	nF	
R ₂ [*]	OUT serial resistor (optional)		50		Ω	
R _{LPU}	OUT pull-up resistance	4		10	kΩ	
R _{LPD}	OUT pull-down resistance	4		10	kΩ	



9.2 Programming the AS5262

The AS5262 programming is a one-time-programming (OTP) method, based on polysilicon fuses. The advantage of this method is that no additional programming voltage is needed. The internal LDO provides the current for programming.

The OTP consists of 128 bits; several bits are available for user programming. In addition factory settings are stored in the OTP memory. Both regions are independently lockable by build in lock bits.

A single OTP cell can be programmed only once. Per default, the cell is "0"; a programmed cell will contain a "1". While it is not possible to reset a programmed bit from "1" to "0", multiple OTP writes are possible, as long as only unprogrammed "0"-bits are programmed to "1".

Independent of the OTP programming, it is possible to overwrite the OTP register temporarily with an OTP write command. This is possible only if the user lock bit is not programmed.

Due to the programming over the output pin the device will initially start in the communication mode. In this mode the digital angle value can be read with a specific protocol format. It is a bidirectional communication possible. Parameters can be written into the device. A programming of the device is triggered by a specific command. With another command (pass2func) the device can be switched into operation mode. In case of a programmed user lock bit the AS5262 automatically starts up in the functional operation mode. No communication of the specific protocol is possible after this.

A standard half duplex UART protocol is used to exchange data with the device in the communication mode.

9.2.1 UART Interface for Programming

The AS5262 uses a standard UART interface with an address byte and two data bytes. The read or write mode is selected with bit R/Wn in the first byte. The timing (baudrate) is selected by the AS5262 over a synchronization frame. The baud rate register can be read and overwritten (optional). Every start bit is used for synchronisation.

A time out function detects not complete commands and resets the AS5262 UART after the timeout period.

9.2.2 Frame Organization

Each frame is composed by 24 bits. The first byte of the frame specifies the read/write operation with the register address. 16 data bits contains the communication data. There will be no operation in case of the usage of a not specified CMD. The UART programming interface block of the AS5262 can operate in slave communication or master communication mode. In the slave communication mode the AS5262 receives the data. The programming tool is the driver of the single communication line. In case of the master communication mode the AS5262 transmits data in the frame format. The single communication line can be pulled down by the AS5262.

The UART frame consists of 1 start bit (low level), 8 data bit, 1 even-parity bit and 1 stop bit (high level). Data are transferred from LSB to MSB

Figure 13. General UART Frame

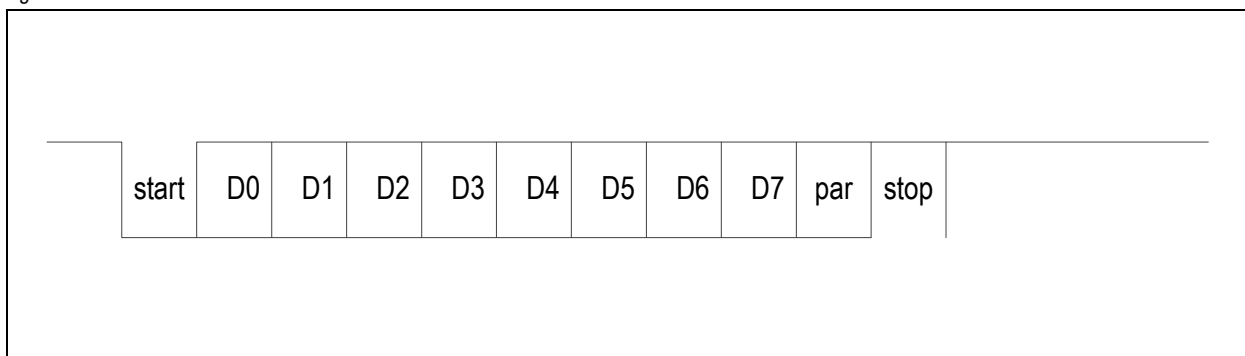

Table 12. Bit Timing

Symbol	Parameter	Min	Typ	Max	Unit	Note
START	Start bit		1		TBIT	
Dx	Data bit		1		TBIT	
PAR	Parity bit		1		TBIT	
STOP	Stop bit	1			TBIT	
TSW	Slave/Master Switch Time		7		TBIT	



Each communication starts with the reception of a request from the external controller. The request consists of two frames: one synchronization frame and the command frame.

The synchronization frame contains the data 0x55 and allows the UART to measure the external controller baud rate:

Figure 14. Synchronization Frame

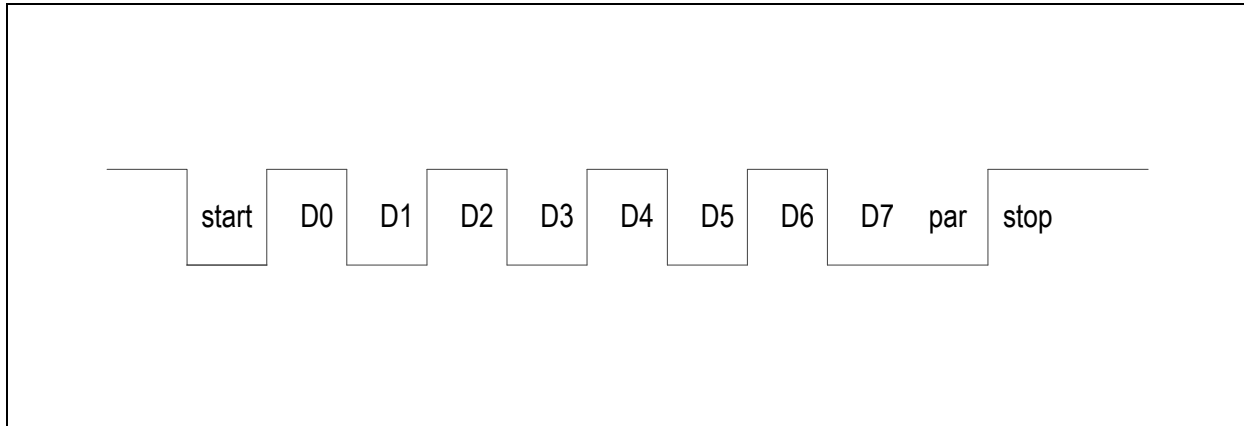

The second frame contains the command Read/ Write (1 bit) and the address (7 bits):

Figure 15. Address and Command Frame

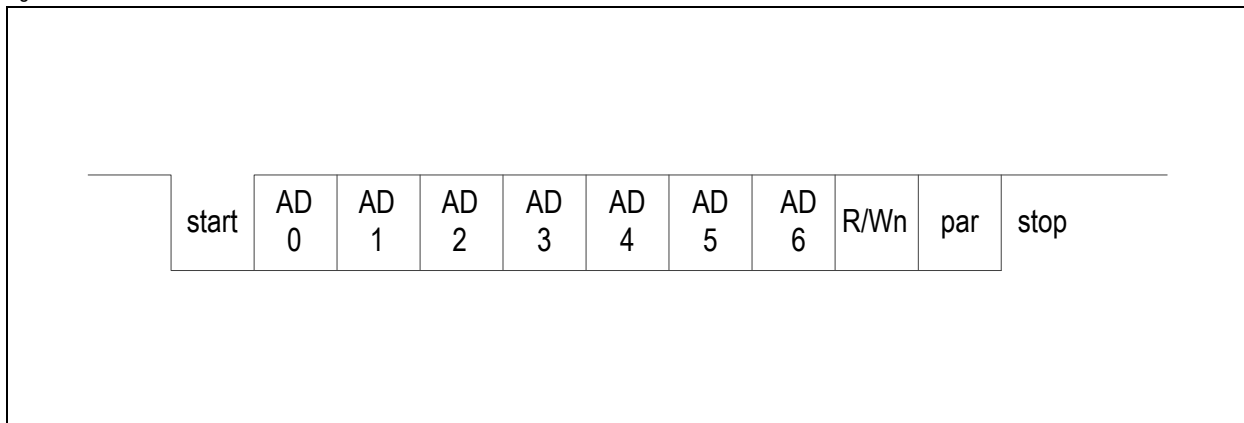

Only two commands are possible. In case of read command the idle phase between the command and the answer is the time TSW. In case of parity error command is not executed.

Table 13. Possible Commands

Possible Interface Commands	Description	AS5X63 Communication Mode	Command CMD
WRITE	Write data to the OTP memory or Registers	SLAVE	0
READ	Read data to the OTP memory or Registers	SLAVE & MASTER	1

Notes:

1. In case of Write command the request is followed by the frames containing the data to write.
2. In case of Read command the communication direction will change and the AS5262 will answer with the frames containing the requested data.



9.2.3 WRITE (Command Description)

Figure 16. Full Write Command

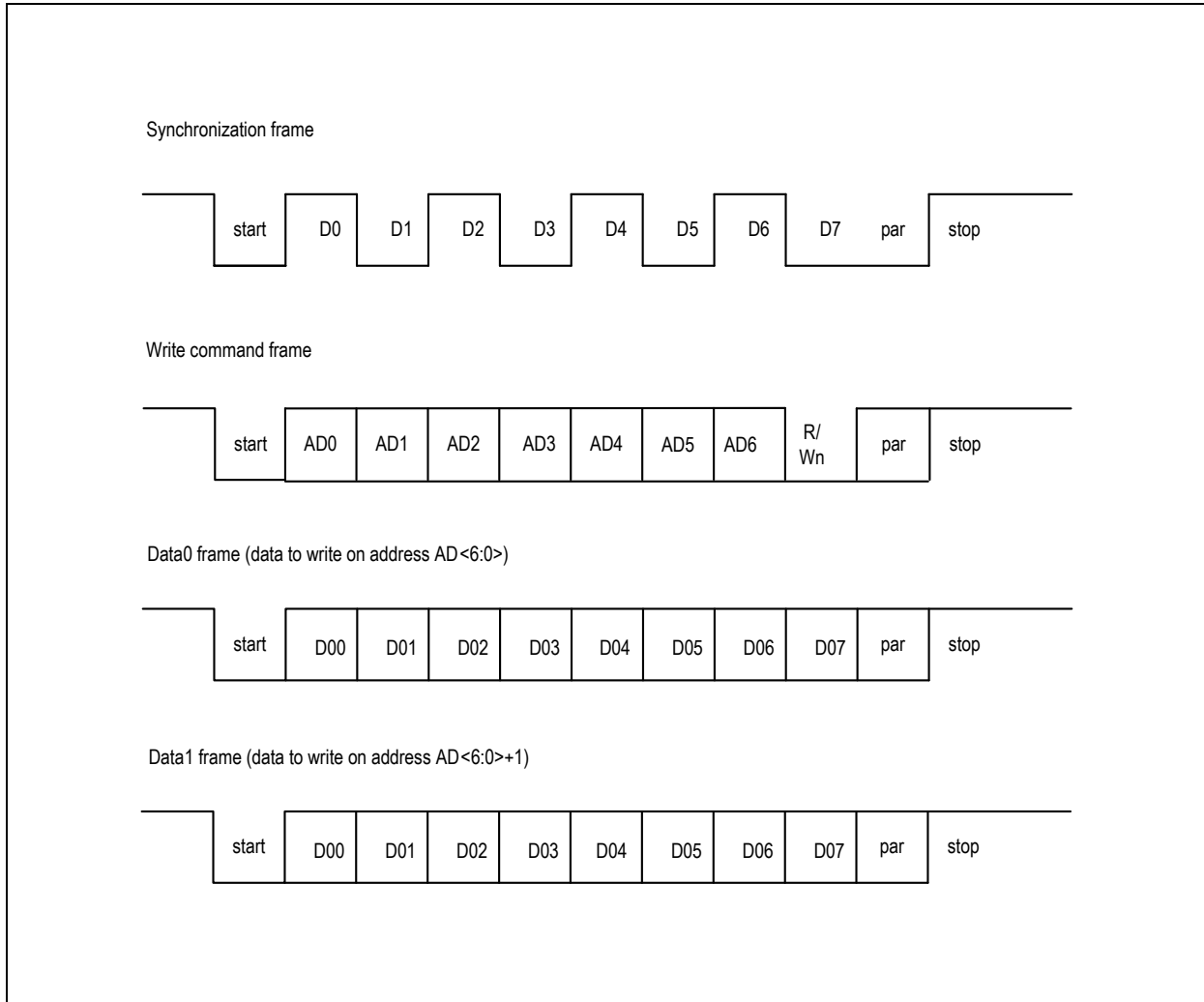

- Writing the AS5262 KEY in the fuse register (address 0x41) triggers the transfer of the data from the OTP RAM into the Poly Fuse cell.
- Writing the AS5262 KEY in the Pass2Func Register (address 0x60) forces the device into normal mode.



9.2.4 READ (Command Description)

Figure 17. Full Read Command

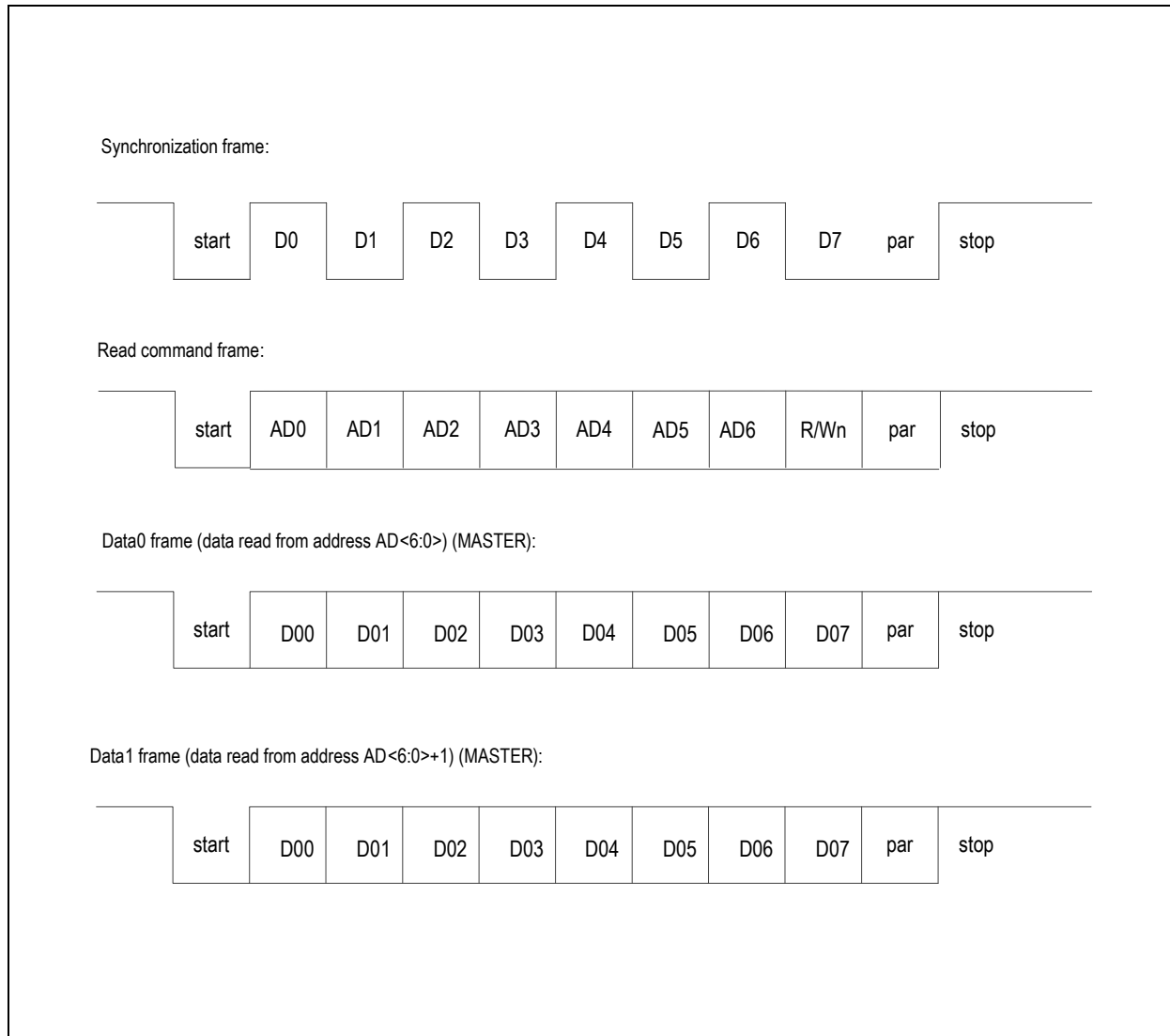

9.2.5 Baud-rate Automatic Detection

The UART includes a built-in baud-rate monitor that uses the synchronization frame to detect the external controller baud-rate. This baud-rate is used after the synchronization byte to decode the following frame and to transmit the answer and it is stored in the BAUDREG register.

9.2.6 Baud-rate Manual Setting (optional)

The BAUDREG register can be read and over-written for a possible manual setting of the baud-rate: in case the register is overwritten with a value different from 0, this value will be used for the following UART communications and the synchronization frame must be removed from the request.



Figure 18. Manual Baud-rate Setting

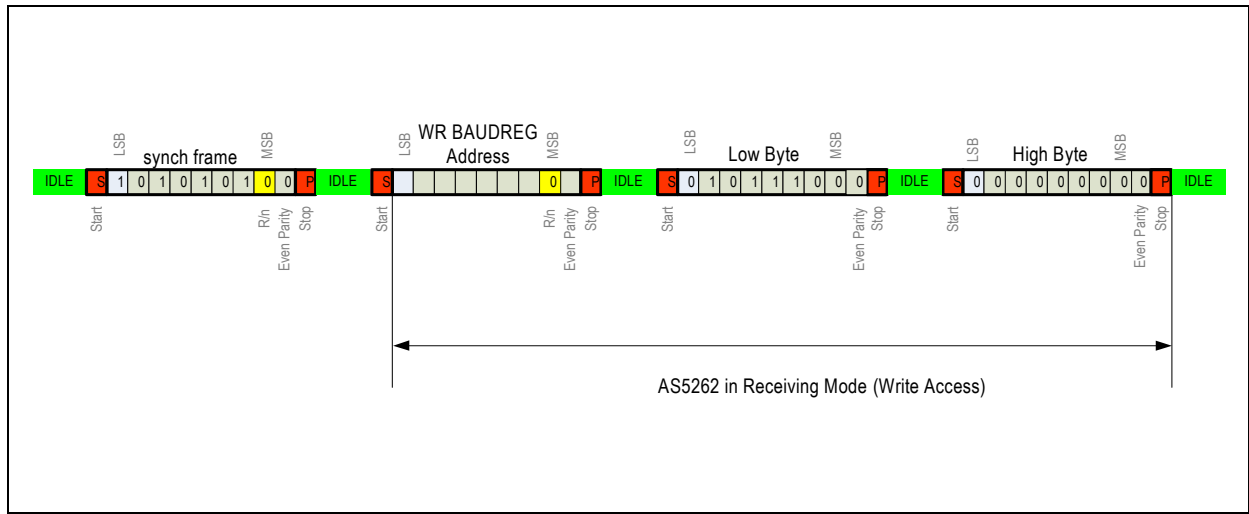
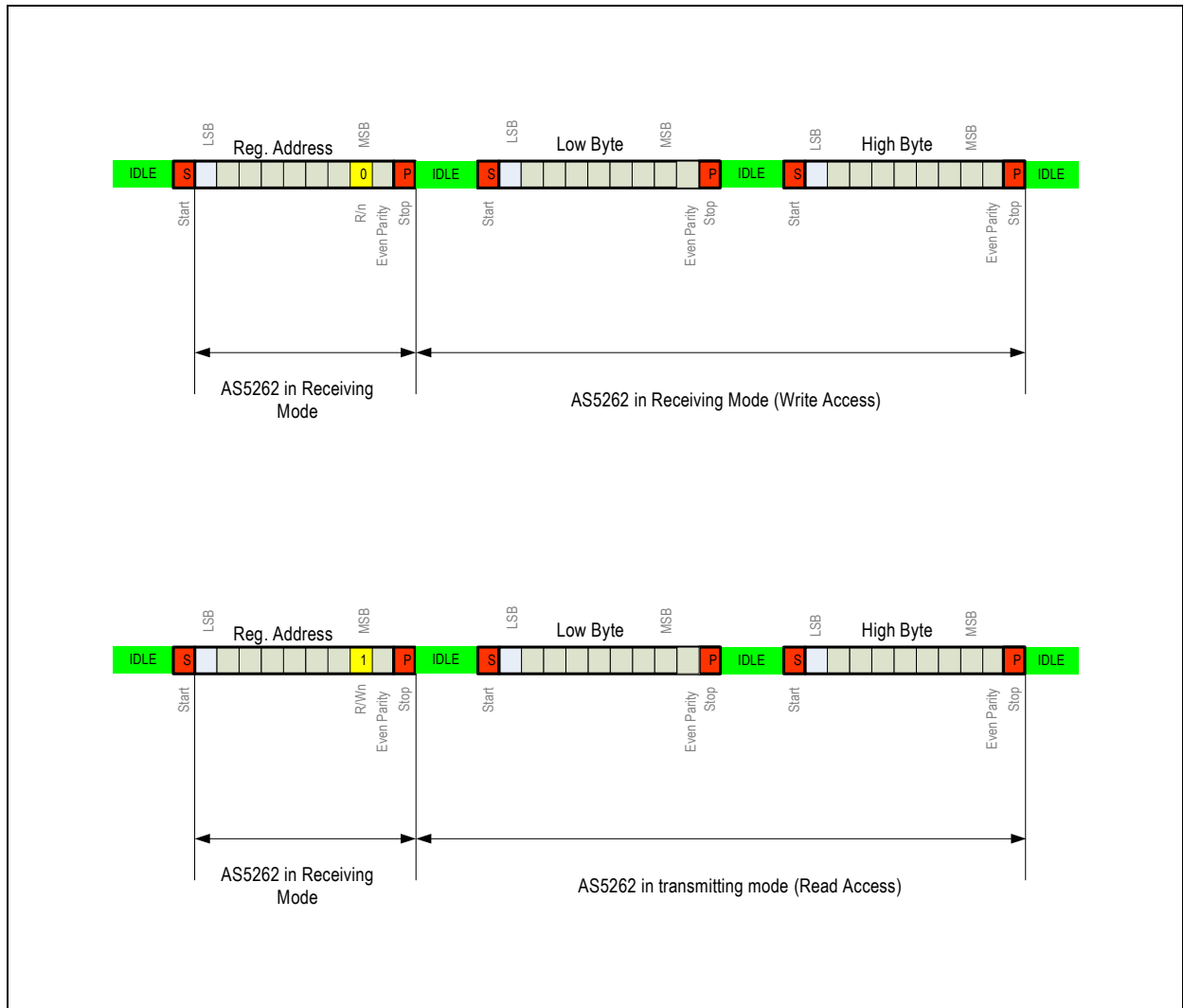

Figure 19. Simple Read and Write





9.3 OTP Programming Data

Table 14. OTP Memory Map

Data Byte	Bit Number	Symbol	Default	Description	
DATA15 (0x0F)	0	Factory Settings	0	AMS (reserved)	Factory Settings
	1		0		
	2		0		
	3		0		
	4		0		
	5		0		
	6		0		
	7		0		
DATA14 (0x0E)	0	Factory Settings	0	AMS (reserved)	Factory Settings
	1		0		
	2		0		
	3		0		
	4		0		
	5		0		
	6		0		
	7		0		
DATA13 (0x0D)	0	Factory Settings	0	AMS (reserved)	Factory Settings
	1		0		
	2	CUSTID<0>	0	Customer Identifier	Customer Settings
	3	CUSTID<1>	0		
	4	CUSTID<2>	0		
	5	CUSTID<3>	0		
	6	CUSTID<4>	0		
	7	CUSTID<5>	0		
DATA12 (0x0C)	0	CUSTID<6>	0	Second linearization point (X-axis)	Customer Settings
	1	X2LIN<0>	0		
	2	X2LIN<1>	0		
	3	X2LIN<2>	0		
	4	X2LIN<3>	0	First linearization point (X-axis)	
	5	X1LIN<0>	0		
	6	X1LIN<1>	0		
	7	X1LIN<2>	0		
DATA11 (0x0B)	0	X1LIN<3>	0	First linearization point (Y-axis)	Customer Settings
	1	Y1LIN<0>	0		



Table 14. OTP Memory Map

Data Byte	Bit Number	Symbol	Default	Description		
	2	Y1LIN<1>	0	First linearization point (Y-axis)	Customer Settings	
	3	Y1LIN<2>	0			
	4	Y2LIN<0>	0	Second linearization point (Y-axis)		
	5	Y2LIN<1>	0			
	6	Y2LIN<2>	0			
	DATA10 (0x0A)	7	CLH<0>	0		Clamping Level High
		0	CLH<1>	0		
1		CLH<2>	0			
2		CLH<3>	0			
3		CLH<4>	0			
4		CLH<5>	0			
5		CLH<6>	0			
6		CLH<7>	0			
DATA9 (0x09)	7	CLH<8>	0	Clamping Level Low		
	0	CLL<0>	0			
	1	CLL<1>	0			
	2	CLL<2>	0			
	3	CLL<3>	0			
	4	CLL<4>	0			
	5	CLL<5>	0			
	6	CLL<6>	0			
DATA8 (0x08)	7	CLL<7>	0	Offset		
	0	CLL<8>	0			
	1	OFFSET<0>	0			
	2	OFFSET<1>	0			
	3	OFFSET<2>	0			
	4	OFFSET<3>	0			
	5	OFFSET<4>	0			
	6	OFFSET<5>	0			
DATA7 (0x07)	7	OFFSET<6>	0			
	0	OFFSET<7>	0			
	1	OFFSET<8>	0			
	2	OFFSET<9>	0			
	3	OFFSET<10>	0			
	4	OFFSET<11>	0			
	5	OFFSET<12>	0			
	6	OFFSET<13>	0			
	7	OFFSET<14>	0			



Table 14. OTP Memory Map

Data Byte	Bit Number	Symbol	Default	Description	
DATA6 (0x06)	0	OFFSET<15>	0	Offset	Customer Settings
	1	OFFSET<16>	0		
	2	OFFSET<17>	0		
	3	OFFSET<18>	0		
	4	OFFSET<19>	0	Scale Factor	
	5	GAIN<0>	0		
	6	GAIN<1>	0		
	7	GAIN<2>	0		
DATA5 (0x05)	0	GAIN<3>	0	Scale Factor	
	1	GAIN<4>	0		
	2	GAIN<5>	0		
	3	GAIN<6>	0		
	4	GAIN<7>	0		
	5	GAIN<8>	0		
	6	GAIN<9>	0		
	7	GAIN<10>	0		
DATA4 (0x04)	0	GAIN<11>	0	Scale Factor	
	1	GAIN<12>	0		
	2	GAIN<13>	0		
	3	GAIN<14>	0		
	4	GAIN<15>	0	Break Point	
	5	GAIN<16>	0		
	6	BP<0>	0		
	7	BP<1>	0		
DATA3 (0x003)	0	BP<2>	0	Break Point	
	1	BP<3>	0		
	2	BP<4>	0		
	3	BP<5>	0		
	4	BP<6>	0		
	5	BP<7>	0		
	6	BP<8>	0		
	7	BP<9>	0		
DATA2 (0x02)	0	BP<10>	0	Break Point	
	1	BP<11>	0		
	2	BP<12>	0		
	3	BP<13>	0		
	4	ANGLERNG	0	Sector selection 0=Angular Sector≥22.5 degrees; 1=Angular Sector<22.5 degrees	
	5	DIAG_HIGH	0	Failure Band Selection 0=Failure Band Low 1=Failure Band High	



Table 14. OTP Memory Map

Data Byte	Bit Number	Symbol	Default	Description	
DATA2 (0x02)	6	QUADEN<0>	0	Quadrant Mode Enable 00=1quadrant;01=2quadrants; 10=3 quadrants;11=4 quadrants	Customer Settings
	7	QUADEN<1>	0		
DATA1 (0x01)	0	AIRGAPSEL	0	Magnetic input range extension 0:extended range;1=normal range	
	1	HYSTSEL<0>	0	Hysteresis selection 00=no hysteresis; 01: 56LSB; 10=91LSB; 11=137LSB	
	2	HYSTSEL<1>	0		
	3	FILTERCFG<0>	0	Filter Configuration 00=no filter; 01= fast; 10=moderate; 11=slow	
	4	FILTERCFG<1>	0		
	5	Not used	0		
	6	Not used	0		
7	Not used	0			
DATA0 (0x00)	0	RED_ADD<0>	0	Redundancy Address Identify the address of the byte containing the bit to be changed	
	1	RED_ADD<1>	0		
	2	RED_ADD<2>	0		
	3	RED_ADD<3>	0		
	4	RED_BIT<0>	0	Redundancy Bit Identify the position of the bit to be changed in the byte at the address RED_ADD<3:0>	
	5	RED_BIT<1>	0		
	6	RED_BIT<2>	0		
	7	CUST_LOCK	0		Lock bit for Customer Area



9.4 READ / WRITE Register Map

Table 15. Read / Write Registers

Data Byte	Bit Number	Symbol	Default	Description	
DATA0 (0x20)	0	BAUDREG<0>	0	UART Baud Rate Register	Read/Write Area
	1	BAUDREG<1>	0		
	2	BAUDREG<2>	0		
	3	BAUDREG<3>	0		
	4	BAUDREG<4>	0		
	5	BAUDREG<5>	0		
	6	BAUDREG<6>	0		
	7	BAUDREG<7>	0		
DATA1 (0x21)	0	BAUDREG<8>	0	A read command returns all data bits at 0	
	1	Not used	0		
	2	Not used	0		
	3	Not used	0		
	4	Not used	0		
	5	Not used	0		
	6	Not used	0		
	7	Not used	0		
DATA2 (0x22)	0	DAC12IN<8>	0	DAC12 buffer value	
	1	DAC12IN<9>	0		
	2	DAC12IN<10>	0		
	3	DAC12IN<11>	0	DAC12 buffer selection	
	4	DAC12INSEL	0		
	5	R1K10K<0>	0	Selection of the reference resistance used for OTP download	
	6	R1K10K<1>	0		
	7	DSPRN	0	Resetrn of the Digital Signal Processing circuit	
DATA3 (0x23)	0	DAC12IN<0>	0	DAC12 buffer value	
	1	DAC12IN<1>	0		
	2	DAC12IN<2>	0		
	3	DAC12IN<3>	0		
	4	DAC12IN<4>	0		
	5	DAC12IN<5>	0		
	6	DAC12IN<6>	0		
	7	DAC12IN<7>	0		



9.5 READ Only Register Map

Table 16. Read Only Registers

Data Byte	Bit Number	Symbol	Default	Description	Read Area
DATA0 (0x28)	0	Not used	0	A read command returns 0	
	1	OFFSETFINISHED	0	Offset compensation finished	
	2	AGCFINISHED	0	AGC loop compensation finished	
	3	CORDICOVF	0	Overflow of the Cordic	
	4	AGCALARML	0	AGC loop saturation because of B field too strong	
	5	AGCALARMH	0	AGC loop saturation because of B field too weak	
	6	OTP_RES	0	0=1K resistance selected for OTP download; 1=10K resistance selected for OTP download	
	7	PARITY_ERR	0	UART parity error flag	
DATA1 (0x29)	0	CORDICOUT<0>	0	Cordic Output	
	1	CORDICOUT<1>	0		
	2	CORDICOUT<2>	0		
	3	CORDICOUT<3>	0		
	4	CORDICOUT<4>	0		
	5	CORDICOUT<5>	0		
	6	CORDICOUT<6>	0		
	7	CORDICOUT<7>	0		
DATA2 (0x2A)	0	CORDICOUT<8>	0		
	1	CORDICOUT<9>	0		
	2	CORDICOUT<10>	0		
	3	CORDICOUT<11>	0		
	4	CORDICOUT<12>	0		
	5	CORDICOUT<13>	0		
	6	Not used	0	A read command returns all data bits at 0	
	7	Not used	0		
DATA3 (0x2B)	0	DSPOUT<0>	0	DSP Output	
	1	DSPOUT<1>	0		
	2	DSPOUT<2>	0		
	3	DSPOUT<3>	0		
	4	DSPOUT<4>	0		
	5	DSPOUT<5>	0		
	6	DSPOUT<6>	0		
	7	DSPOUT<7>	0		



Table 16. Read Only Registers

Data Byte	Bit Number	Symbol	Default	Description	
DATA4 (0x2C)	0	DSPOUT<8>	0	DSP Output	Read Area
	1	DSPOUT<9>	0		
	2	DSPOUT<10>	0		
	3	DSPOUT<11>	0		
	4	Not used	0	A read command returns all data bits at 0	
	5	Not used	0		
	6	Not used	0		
	7	Not used	0		
DATA5 (0x2D)	0	AGCVALUE<0>	0	AGC Value	
	1	AGCVALUE<1>	0		
	2	AGCVALUE<2>	0		
	3	AGCVALUE<3>	0		
	4	AGCVALUE<4>	0		
	5	AGCVALUE<5>	0		
	6	AGCVALUE<6>	0		
	7	AGCVALUE<7>	0		
DATA6 (0x2E)	0	MAG<0>	0	Magnitude of magnetic field	
	1	MAG<1>	0		
	2	MAG<2>	0		
	3	MAG<3>	0		
	4	MAG<4>	0		
	5	MAG<5>	0		
	6	MAG<6>	0		
	7	MAG<7>	0		
DATA7 (0x2F)	0	Not used	0	A read command returns all data bits at 0	
	1	Not used	0		
	2	Not used	0		
	3	Not used	0		
	4	Not used	0		
	5	Not used	0		
	6	Not used	0		
	7	Not used	0		



9.6 Special Registers

Table 17. Special Registers

Data Byte	Bit Number	Symbol	Default	Description	
DATA0 (0x41)	0	AS5262KEY<0>	0	AS5262 KEY<15:0>=0101 0001 0110 0010 A write command with data different from AS5262 KEY is not executed A read command returns all data bits at 0	Fuse Register
	1	AS5262KEY<1>	0		
	2	AS5262KEY<2>	0		
	3	AS5262KEY<3>	0		
	4	AS5262KEY<4>	0		
	5	AS5262KEY<5>	0		
	6	AS5262KEY<6>	0		
	7	AS5262KEY<7>	0		
DATA1 (0x42)	0	AS5262KEY<8>	0		
	1	AS5262KEY<9>	0		
	2	AS5262KEY<10>	0		
	3	AS5262KEY<11>	0		
	4	AS5262KEY<12>	0		
	5	AS5262KEY<13>	0		
	6	AS5262KEY<14>	0		
	7	AS5262KEY<15>	0		
DATA0 (0x60)	0	AS5262KEY<0>	0	AS5262 KEY<15:0>=0101 0001 0110 0010 A write command with data different from AS5262 KEY is not executed A read command returns all data bits at 0	Pass2Func Register
	1	AS5262KEY<1>	0		
	2	AS5262KEY<2>	0		
	3	AS5262KEY<3>	0		
	4	AS5262KEY<4>	0		
	5	AS5262KEY<5>	0		
	6	AS5262KEY<6>	0		
	7	AS5262KEY<7>	0		
DATA1 (0x61)	0	AS5262KEY<8>	0		
	1	AS5262KEY<9>	0		
	2	AS5262KEY<10>	0		
	3	AS5262KEY<11>	0		
	4	AS5262KEY<12>	0		
	5	AS5262KEY<13>	0		
	6	AS5262KEY<14>	0		
	7	AS5262KEY<15>	0		



9.7 Programming Procedure

- Pull-up on out pin
- VDD=5V
- Wait 10ms (after the startup time device enters communication mode)
- Write command: Trimming bits are written in the OTP RAM
- Read command: All the trimming bits are read back to check the correctness of the writing procedure.
- Write AS5262KEY in the Fuse register: The OTP RAM content is permanently transferred into the Poly Fuse cells.
- Wait 10 ms (fuse time)
- Write command, R1K_10K<1:0>=(11)b: Poly Fuse cells are downloaded into the RAM memory using a 10K resistance as reference.
- Wait 5 ms (download time)
- Read R1K_10K register, the expected value is 00b
- Write command, R1K_10K<1:0>=(11)b
- Read R1K_10K register, the expected value is (11)b. NB: Step11 and Step12 have to be consecutive.
- Read command: all the fused bits downloaded with 10K resistance are read back.
- Write command, R1K_10K=<1:0>=(10)b: Poly Fuse cells are downloaded into the RAM memory using a 1K resistance as reference.
- Wait 5 ms (download time)
- Read R1K_10K register, the expected value is (00)b
- Write command register, R1K_10K<1:0>=(10)b
- Read R1K_10K register, the expected value is (10)b NB: Step18 and Step19 have to be consecutive.
- Read command: All the fused bits downloaded with 1K resistance are read back.
- Check that read commands at Steps 5, 13 and 19 are matching
- Write AS5262KEY in the Pass2Func register: Device enters normal mode.



10 Package Drawings and Markings

The device is available in a MLF-16 package.

Figure 20. Package Drawings and Dimensions

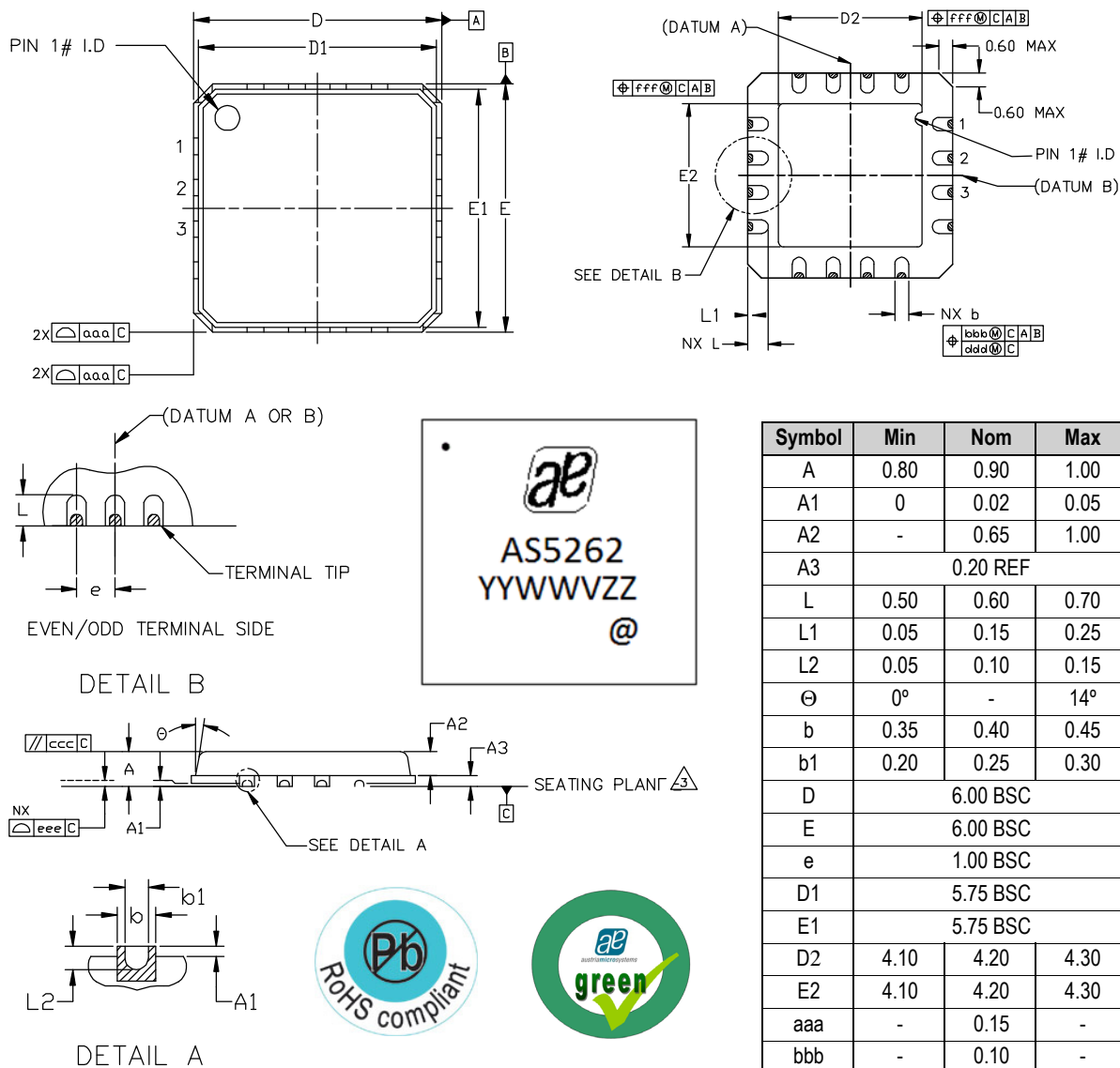

Symbol	Min	Nom	Max
A	0.80	0.90	1.00
A1	0	0.02	0.05
A2	-	0.65	1.00
A3	0.20 REF		
L	0.50	0.60	0.70
L1	0.05	0.15	0.25
L2	0.05	0.10	0.15
θ	0°	-	14°
b	0.35	0.40	0.45
b1	0.20	0.25	0.30
D	6.00 BSC		
E	6.00 BSC		
e	1.00 BSC		
D1	5.75 BSC		
E1	5.75 BSC		
D2	4.10	4.20	4.30
E2	4.10	4.20	4.30
aaa	-	0.15	-
bbb	-	0.10	-
ccc	-	0.10	-
ddd	-	0.05	-
eee	-	0.08	-
fff	-	0.10	-
N	16		

Notes:

1. Dimensions and tolerancing confirm to ASME Y14.5M-1994.
2. All dimensions are in millimeters. Angles are in degrees.
3. Bilateral coplanarity zone applies to the exposed pad as well as the terminal.
4. Radius on the terminal is optional.
5. N is the total number of terminals.

Marking: YYWWVZZ.

YY	WW	V	ZZ
Year	Week	Assembly plant identifier	Assembly traceability code



Figure 21. Vertical Cross Section of MLF-16

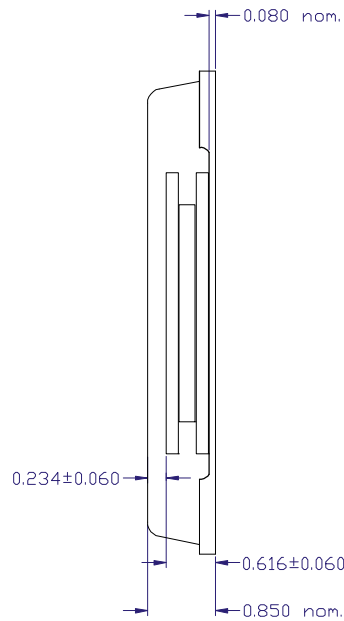
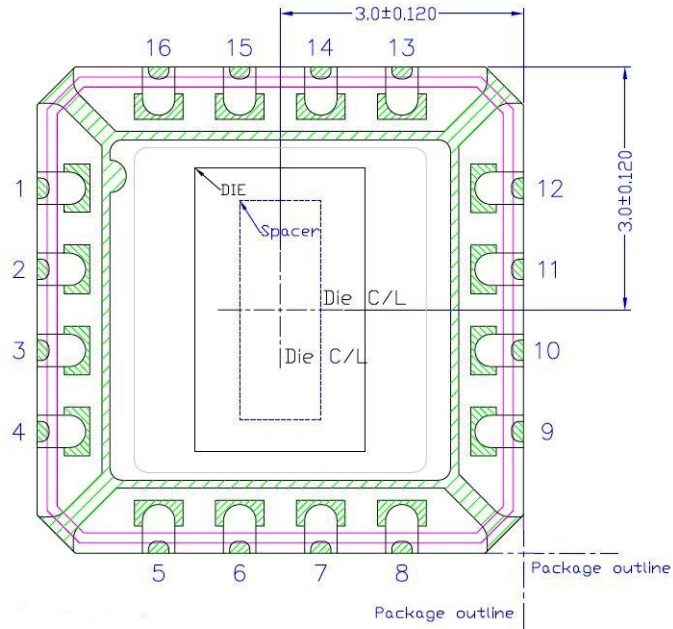

Notes:

1. All dimensions in mm.
2. Die thickness 0.150mm nom.
3. Adhesive thickness 0.011mm.
4. Spacer thickness 0.203mm typ.



Revision History

Revision	Date	Owner	Description
1.0	Oct 30, 2012	mub	Initial revision
1.1	Oct 31, 2012		Updated Figure 3 , Table 1 , Table 2 , Table 10 and Figure 12

Note: Typos may not be explicitly mentioned under revision history.



11 Ordering Information

The devices are available as the standard products shown in [Table 18](#).

Table 18. Ordering Information

Ordering Code	Description	Delivery Form	Package
AS5262-HMFP, -HMFM	12-bit programmable redundant angle position sensor with analog outputs	Tape&Reel	MLF 16 6x6

Note: All products are RoHS compliant and ams green.
Buy our products or get free samples online at www.ams.com/ICdirect

Technical Support is available at www.ams.com/Technical-Support

For further information and requests, email us at sales@ams.com
(or) find your local distributor at www.ams.com/distributor



Copyrights

Copyright © 1997-2012, ams AG, Tobelbaderstrasse 30, 8141 Unterpremstaetten, Austria-Europe. Trademarks Registered ®. All rights reserved. The material herein may not be reproduced, adapted, merged, translated, stored, or used without the prior written consent of the copyright owner.

All products and companies mentioned are trademarks or registered trademarks of their respective companies.

Disclaimer

Devices sold by ams AG are covered by the warranty and patent indemnification provisions appearing in its Term of Sale. ams AG makes no warranty, express, statutory, implied, or by description regarding the information set forth herein or regarding the freedom of the described devices from patent infringement. ams AG reserves the right to change specifications and prices at any time and without notice. Therefore, prior to designing this product into a system, it is necessary to check with ams AG for current information. This product is intended for use in normal commercial applications. Applications requiring extended temperature range, unusual environmental requirements, or high reliability applications, such as military, medical life-support or life-sustaining equipment are specifically not recommended without additional processing by ams AG for each application. For shipments of less than 100 parts the manufacturing flow might show deviations from the standard production flow, such as test flow or test location.

The information furnished here by ams AG is believed to be correct and accurate. However, ams AG shall not be liable to recipient or any third party for any damages, including but not limited to personal injury, property damage, loss of profits, loss of use, interruption of business or indirect, special, incidental or consequential damages, of any kind, in connection with or arising out of the furnishing, performance or use of the technical data herein. No obligation or liability to recipient or any third party shall arise or flow out of ams AG rendering of technical or other services.



Contact Information

Headquarters

ams AG
Tobelbaderstrasse 30
A-8141 Unterpremstaetten, Austria

Tel : +43 (0) 3136 500 0
Fax : +43 (0) 3136 525 01

For Sales Offices, Distributors and Representatives, please visit:

<http://www.ams.com/contact>

X-ON Electronics

Largest Supplier of Electrical and Electronic Components

Click to view similar products for [Board Mount Hall Effect/Magnetic Sensors](#) category:

Click to view products by [ams](#) manufacturer:

Other Similar products are found below :

[HGPRDT005A](#) [AH277AZ4-AG1](#) [AV-10379](#) [AV-10448](#) [SS41C](#) [AH1894-Z-7](#) [ATS601LSGTN-LT-WU4-T](#) [TLE4917](#) [50017859-003](#) [TY-13101](#) [TLE4976L](#) [AH49FNTR-G1](#) [SS85CA](#) [AH277AZ4-BG1](#) [TLE49614MXTSA1](#) [AH3377-P-B](#) [AH211Z4-AG1](#) [AH3360-FT4-7](#) [SS460S-100SAMPLE](#) [50065820-03](#) [TLE4941PLUSCB](#) [AH374-P-A](#) [AH1806-P-A](#) [AH374-W-7](#) [SS460P-T2](#) [SS413F](#) [TLE5046ICAKLRHALA1](#) [TLE49421CHAMA2](#) [TLE4941PLUSCXAMA1](#) [AH1912-W-EVM](#) [AH1903-FA-EVM](#) [AH3774-W-EVM](#) [AH49FNTR-EVM](#) [MMC5633NJL](#) [AH3360-FA-EVM](#) [AH8502-FDC-EVM](#) [AH3366Q-SA-EVM](#) [AH3774-P-EVM](#) [KTH1601SU-ST3](#) [MG910](#) [MG910M](#) [MG911](#) [MG610](#) [MW921](#) [MW922](#) [TLE4998S3XALA1](#) [TLE5011FUMA1](#) [TLE5027CE6747HAMA1](#) [TLE5109A16E2210XUMA1](#) [TLI4966GHTSA1](#)