

- Approximates Human Eye Response
- Approximately 4× More Sensitive Than TSL2560/61 Device
- Programmable Interrupt Function with User-Defined Upper and Lower Threshold Settings
- 16-Bit Digital Output with SMBus (TSL2568) at 100 kHz or I<sup>2</sup>C (TSL2569) Fast-Mode at 400 kHz
- Programmable Analog Gain and Integration Time Supporting 1,000,000-to-1 Dynamic Range
- Available in Ultra-Small 1.25 mm × 1.75 mm ChipScale Package
- Automatically Rejects 50/60-Hz Lighting Ripple
- Low Active Power (0.75 mW Typical) with Power Down Mode
- RoHS Compliant

**PACKAGE CS  
6-LEAD CHIPSCALE  
(TOP VIEW)**

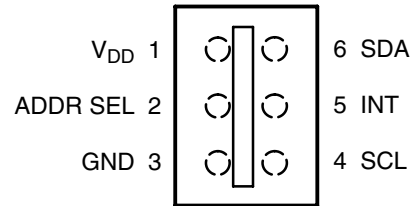

Package Drawings are Not to Scale

**PACKAGE T  
6-LEAD TMB  
(TOP VIEW)**

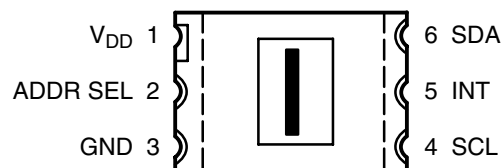

## Description

The TSL2568 and TSL2569 are high-sensitivity light-to-digital converters that transform light intensity to a digital signal output capable of direct I<sup>2</sup>C (TSL2569) or SMBus (TSL2568) interface. Each device combines one broadband photodiode (visible plus infrared) and one infrared-responding photodiode on a single CMOS integrated circuit capable of providing a near-photopic response over an effective 20-bit dynamic range (16-bit resolution). Two integrating ADCs convert the photodiode currents to a digital output that represents the irradiance measured on each channel. This digital output can be input to a microprocessor where illuminance (ambient light level) in lux is derived using an empirical formula to approximate the human eye response. The TSL2568 device permits an SMB-Alert style interrupt, and the TSL2569 device supports a traditional level style interrupt that remains asserted until the firmware clears it.

While useful for general purpose light sensing applications, the TSL2568/69 devices are designed particularly for display panels (LCD, OLED, etc.) with the purpose of extending battery life and providing optimum viewing in diverse lighting conditions. Display panel backlighting, which can account for up to 30 to 40 percent of total platform power, can be automatically managed. Both devices are also ideal for controlling keyboard illumination based upon ambient lighting conditions. Illuminance information can further be used to manage exposure control in digital cameras. The TSL2568/69 devices are ideal in notebook/tablet PCs, LCD monitors, flat-panel televisions, cell phones, and digital cameras. In addition, other applications include street light control, security lighting, sunlight harvesting, machine vision, and automotive instrumentation clusters.

# TSL2568, TSL2569 LIGHT-TO-DIGITAL CONVERTER

TAOS091D – DECEMBER 2008

## Functional Block Diagram

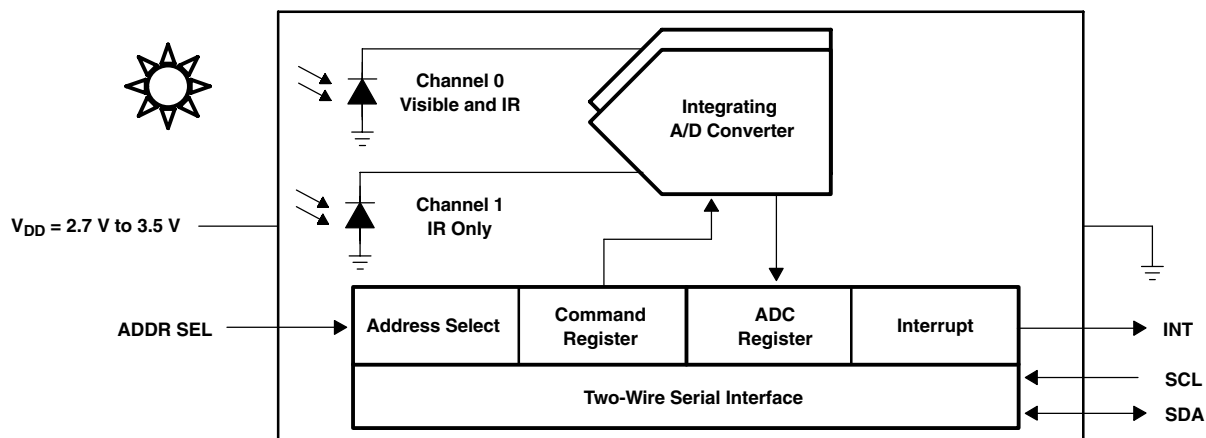

## Detailed Description

The TSL2568 and TSL2569 are second-generation ambient light sensor devices. Each contains two integrating analog-to-digital converters (ADC) that integrate currents from two photodiodes. Integration of both channels occurs simultaneously. Upon completion of the conversion cycle, the conversion result is transferred to the Channel 0 and Channel 1 data registers, respectively. The transfers are double-buffered to ensure that the integrity of the data is maintained. After the transfer, the device automatically begins the next integration cycle.

Communication to the device is accomplished through a standard, two-wire SMBus or I<sup>2</sup>C serial bus. Consequently, the TSL256x device can be easily connected to a microcontroller or embedded controller. No external circuitry is required for signal conditioning, thereby saving PCB real estate as well. Since the output of the TSL256x device is digital, the output is effectively immune to noise when compared to an analog signal.

The TSL256x devices also support an interrupt feature that simplifies and improves system efficiency by eliminating the need to poll a sensor for a light intensity value. The primary purpose of the interrupt function is to detect a meaningful change in light intensity. The concept of a *meaningful change* can be defined by the user both in terms of light intensity and time, or persistence, of that change in intensity. The TSL256x devices have the ability to define a threshold above and below the current light level. An interrupt is generated when the value of a conversion exceeds either of these limits.

**Terminal Functions**

TERMINAL NAME	T PKG NO.	TYPE	DESCRIPTION
ADDR SEL	2	I	SMBus device select — three-state
GND	3		Power supply ground. All voltages are referenced to GND.
INT	5	O	Level or SMB Alert interrupt — open drain.
SCL	4	I	SMBus serial clock input terminal — clock signal for SMBus serial data.
SDA	6	I/O	SMBus serial data I/O terminal — serial data I/O for SMBus.
V <sub>DD</sub>	1		Supply voltage.

**Available Options**

DEVICE	INTERFACE	PACKAGE - LEADS	PACKAGE DESIGNATOR	ORDERING NUMBER
TSL2568	SMBus	Chipscale	CS	TSL2568CS
TSL2568	SMBus	TMB-6	T	TSL2568T
TSL2569	I <sup>2</sup> C	Chipscale	CS	TSL2569CS
TSL2569	I <sup>2</sup> C	TMB-6	T	TSL2569T

**Absolute Maximum Ratings over operating free-air temperature range (unless otherwise noted)†**

Supply voltage, V <sub>DD</sub> (see Note 1)	3.8 V
Digital output voltage range, V <sub>O</sub>	–0.5 V to 3.8 V
Digital output current, I <sub>O</sub>	–1 mA to 20 mA
Storage temperature range, T <sub>stg</sub>	–40°C to 85°C
ESD tolerance, human body model	2000 V

† Stresses beyond those listed under “absolute maximum ratings” may cause permanent damage to the device. These are stress ratings only, and functional operation of the device at these or any other conditions beyond those indicated under “recommended operating conditions” is not implied. Exposure to absolute-maximum-rated conditions for extended periods may affect device reliability.

NOTE 1: All voltages are with respect to GND.

**Recommended Operating Conditions**

	MIN	NOM	MAX	UNIT
Supply voltage, V <sub>DD</sub>	2.7	3	3.6	V
Operating free-air temperature, T <sub>A</sub>	–30		70	°C
SCL, SDA input low voltage, V <sub>IL</sub>	–0.5		0.8	V
SCL, SDA input high voltage, V <sub>IH</sub>	2.1		3.6	V

**Electrical Characteristics over recommended operating free-air temperature range (unless otherwise noted)**

PARAMETER		TEST CONDITIONS	MIN	TYP	MAX	UNIT
I <sub>DD</sub>	Supply current	Active		0.24	0.6	mA
		Power down		3.2	15	μA
V <sub>OL</sub>	INT, SDA output low voltage	3 mA sink current	0		0.4	V
I <sub>LEAK</sub>	Leakage current		–5		5	μA

# TSL2568, TSL2569 LIGHT-TO-DIGITAL CONVERTER

TAOS091D – DECEMBER 2008

**Operating Characteristics, High Gain (16×), V<sub>DD</sub> = 3 V, T<sub>A</sub> = 25°C, (unless otherwise noted) (see Notes 2, 3, 4, 5)**

PARAMETER	TEST CONDITIONS	CHANNEL	TSL2568T, TSL2569T			TSL2568CS, TSL2569CS			UNIT
			MIN	TYP	MAX	MIN	TYP	MAX	
f <sub>osc</sub>	Oscillator frequency		690	735	780	690	735	780	kHz
Dark ADC count value	E <sub>e</sub> = 0, T <sub>int</sub> = 402 ms	Ch0	0		8	0		8	counts
		Ch1	0		8	0		8	
Full scale ADC count value (Note 6)	T <sub>int</sub> > 178 ms	Ch0			65535			65535	counts
		Ch1			65535			65535	
	T <sub>int</sub> = 101 ms	Ch0			37177			37177	
		Ch1			37177			37177	
	T <sub>int</sub> = 13.7 ms	Ch0			5047			5047	
		Ch1			5047			5047	
ADC count value	λ <sub>p</sub> = 640 nm, T <sub>int</sub> = 101 ms E <sub>e</sub> = 33 μW/cm <sup>2</sup>	Ch0	3000	4000	5000				counts
		Ch1		1000					
	λ <sub>p</sub> = 940 nm, T <sub>int</sub> = 101 ms E <sub>e</sub> = 106 μW/cm <sup>2</sup>	Ch0	2800	4000	5200				counts
		Ch1		3520					
	λ <sub>p</sub> = 640 nm, T <sub>int</sub> = 101 ms E <sub>e</sub> = 34.5 μW/cm <sup>2</sup>	Ch0				3000	4000	5000	counts
		Ch1					840		
	λ <sub>p</sub> = 940 nm, T <sub>int</sub> = 101 ms E <sub>e</sub> = 110.9 μW/cm <sup>2</sup>	Ch0				2800	4000	5200	counts
		Ch1					3440		
ADC count value ratio: Ch1/Ch0	λ <sub>p</sub> = 640 nm, T <sub>int</sub> = 101 ms		0.18	0.25	0.32	0.14	0.21	0.28	
	λ <sub>p</sub> = 940 nm, T <sub>int</sub> = 101 ms		0.73	0.88	1.03	0.70	0.86	1.01	
R <sub>e</sub> Irradiance responsivity	λ <sub>p</sub> = 640 nm, T <sub>int</sub> = 101 ms	Ch0		121			116		counts/ (μW/ cm <sup>2</sup> )
		Ch1		30.3			24		
	λ <sub>p</sub> = 940 nm, T <sub>int</sub> = 101 ms	Ch0		37.7			36		
		Ch1		33.2			31		
R <sub>v</sub> Illuminance responsivity	Fluorescent light source: T <sub>int</sub> = 402 ms	Ch0		185			180		counts/ lux
		Ch1		35			33.3		
	Incandescent light source: T <sub>int</sub> = 402 ms	Ch0		599			537		
		Ch1		330			307		
ADC count value ratio: Ch1/Ch0	Fluorescent light source: T <sub>int</sub> = 402 ms			0.19			0.19		
	Incandescent light source: T <sub>int</sub> = 402 ms			0.55			0.57		
R <sub>v</sub> Illuminance responsivity, low gain mode (Note 7)	Fluorescent light source: T <sub>int</sub> = 402 ms	Ch0		11.6			11.1		counts/ lux
		Ch1		2.2			2.1		
	Incandescent light source: T <sub>int</sub> = 402 ms	Ch0		37.5			33.8		
		Ch1		20.7			19.3		
(Sensor Lux) / (actual Lux), high gain mode (Note 8)	Fluorescent light source: T <sub>int</sub> = 402 ms		0.65	1	1.35	0.65	1	1.35	
	Incandescent light source: T <sub>int</sub> = 402 ms		0.60	1	1.40	0.60	1	1.40	

- NOTES:
2. Optical measurements are made using small-angle incident radiation from light-emitting diode optical sources. Visible 640 nm LEDs and infrared 940 nm LEDs are used for final product testing for compatibility with high-volume production.
  3. The 640 nm irradiance  $E_e$  is supplied by an AlInGaP light-emitting diode with the following characteristics: peak wavelength  $\lambda_p = 640$  nm and spectral halfwidth  $\Delta\lambda_{1/2} = 17$  nm.
  4. The 940 nm irradiance  $E_e$  is supplied by a GaAs light-emitting diode with the following characteristics: peak wavelength  $\lambda_p = 940$  nm and spectral halfwidth  $\Delta\lambda_{1/2} = 40$  nm.
  5. Integration time  $T_{int}$ , is dependent on internal oscillator frequency ( $f_{osc}$ ) and on the integration field value in the timing register as described in the *Register Set* section. For nominal  $f_{osc} = 735$  kHz, nominal  $T_{int} = (\text{number of clock cycles})/f_{osc}$ .  
 Field value 00:  $T_{int} = (11 \times 918)/f_{osc} = 13.7$  ms  
 Field value 01:  $T_{int} = (81 \times 918)/f_{osc} = 101$  ms  
 Field value 10:  $T_{int} = (322 \times 918)/f_{osc} = 402$  ms  
 Scaling between integration times vary proportionally as follows:  $11/322 = 0.034$  (field value 00),  $81/322 = 0.252$  (field value 01), and  $322/322 = 1$  (field value 10).
  6. Full scale ADC count value is limited by the fact that there is a maximum of one count per two oscillator frequency periods and also by a 2-count offset.  
 Full scale ADC count value =  $((\text{number of clock cycles})/2 - 2)$   
 Field value 00: Full scale ADC count value =  $((11 \times 918)/2 - 2) = 5047$   
 Field value 01: Full scale ADC count value =  $((81 \times 918)/2 - 2) = 37177$   
 Field value 10: Full scale ADC count value = 65535, which is limited by 16 bit register. This full scale ADC count value is reached for 131074 clock cycles, which occurs for  $T_{int} = 178$  ms for nominal  $f_{osc} = 735$  kHz.
  7. Low gain mode has 16x lower gain than high gain mode:  $(1/16 = 0.0625)$ .
  8. The sensor Lux is calculated using the empirical formula shown on p. 22 of this data sheet based on measured Ch0 and Ch1 ADC count values for the light source specified. Actual Lux is obtained with a commercial luxmeter. The range of the (sensor Lux) / (actual Lux) ratio is estimated based on the variation of the 640 nm and 940 nm optical parameters. Devices are not 100% tested with fluorescent or incandescent light sources.

**AC Electrical Characteristics,  $V_{DD} = 3$  V,  $T_A = 25^\circ\text{C}$  (unless otherwise noted)**

PARAMETER†		TEST CONDITIONS	MIN	TYP	MAX	UNIT
$t_{(CONV)}$	Conversion time		12	100	400	ms
$f_{(SCL)}$	Clock frequency (I <sup>2</sup> C only)		0		400	kHz
	Clock frequency (SMBus only)		10		100	kHz
$t_{(BUF)}$	Bus free time between start and stop condition		1.3			$\mu\text{s}$
$t_{(HDSTA)}$	Hold time after (repeated) start condition. After this period, the first clock is generated.		0.6			$\mu\text{s}$
$t_{(SUSTA)}$	Repeated start condition setup time		0.6			$\mu\text{s}$
$t_{(SUSTO)}$	Stop condition setup time		0.6			$\mu\text{s}$
$t_{(HDDAT)}$	Data hold time		0		0.9	$\mu\text{s}$
$t_{(SUDAT)}$	Data setup time		100			ns
$t_{(LOW)}$	SCL clock low period		1.3			$\mu\text{s}$
$t_{(HIGH)}$	SCL clock high period		0.6			$\mu\text{s}$
$t_{(TIMEOUT)}$	Detect clock/data low timeout (SMBus only)		25		35	ms
$t_F$	Clock/data fall time				300	ns
$t_R$	Clock/data rise time				300	ns
$C_i$	Input pin capacitance				10	pF

† Specified by design and characterization; not production tested.

# TSL2568, TSL2569 LIGHT-TO-DIGITAL CONVERTER

TAOS091D – DECEMBER 2008

## PARAMETER MEASUREMENT INFORMATION

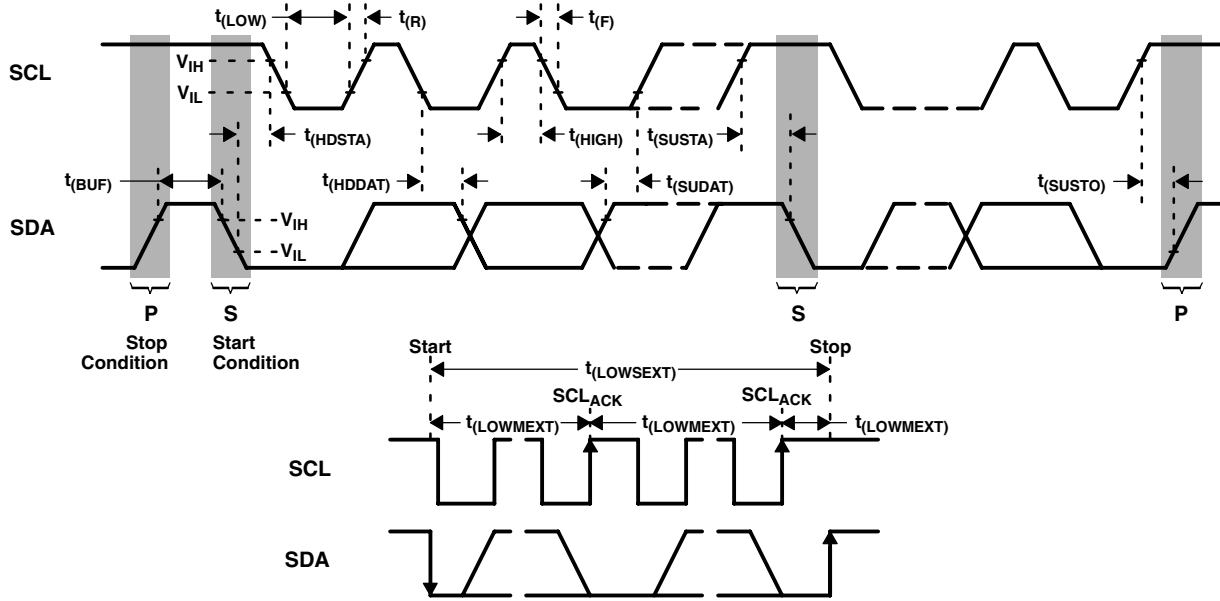

Figure 1. Timing Diagrams

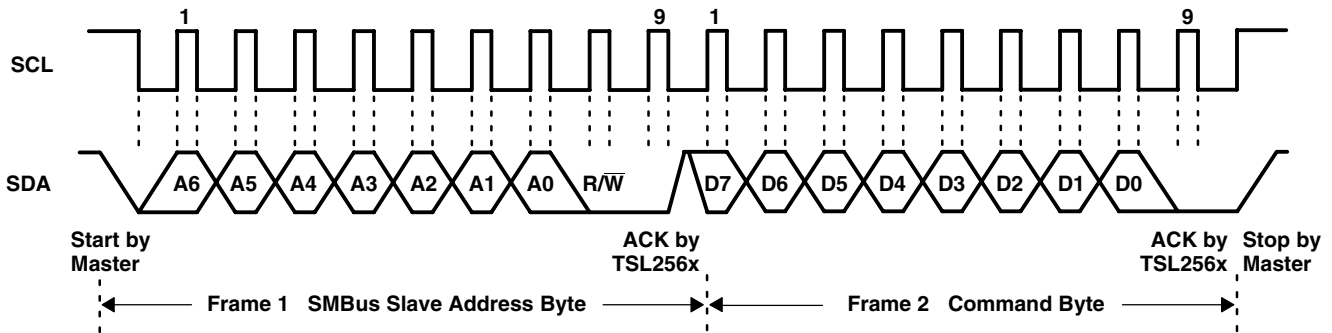

Figure 2. Example Timing Diagram for SMBus Send Byte Format

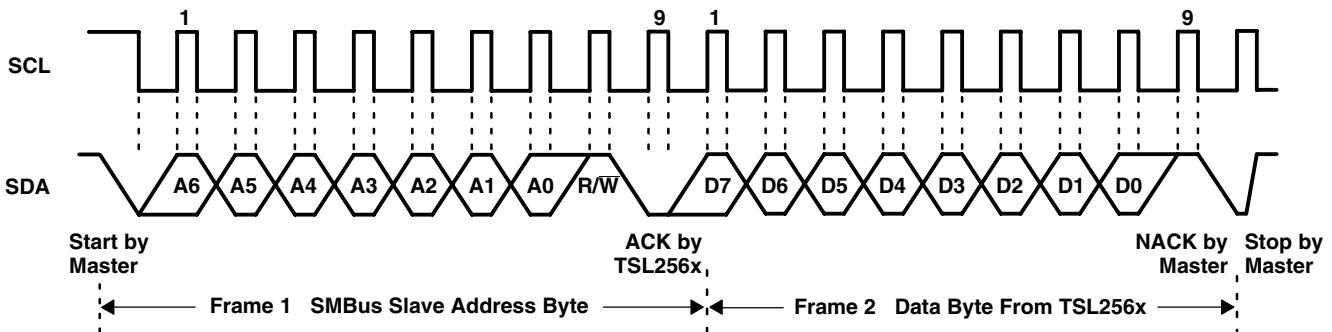

Figure 3. Example Timing Diagram for SMBus Receive Byte Format

TYPICAL CHARACTERISTICS

SPECTRAL RESPONSIVITY

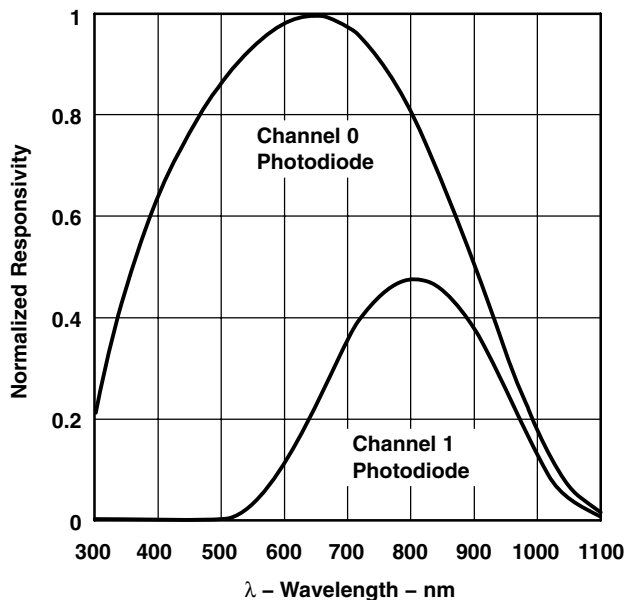

Figure 4

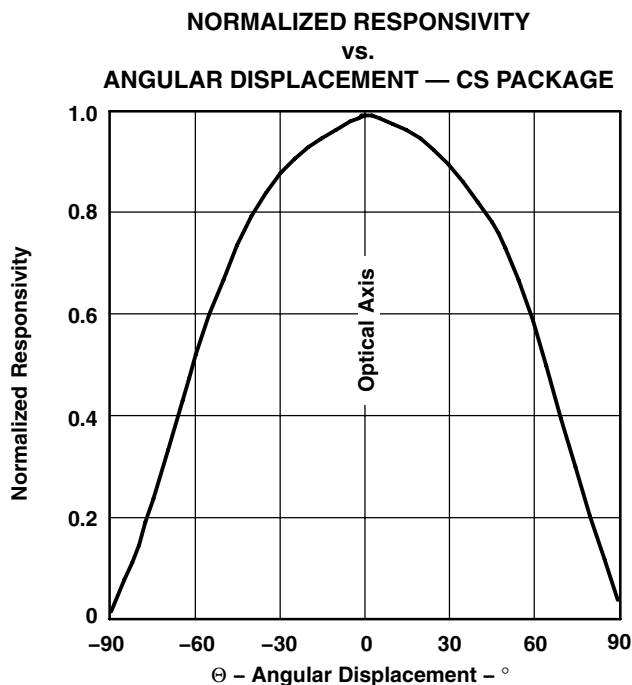

Figure 5

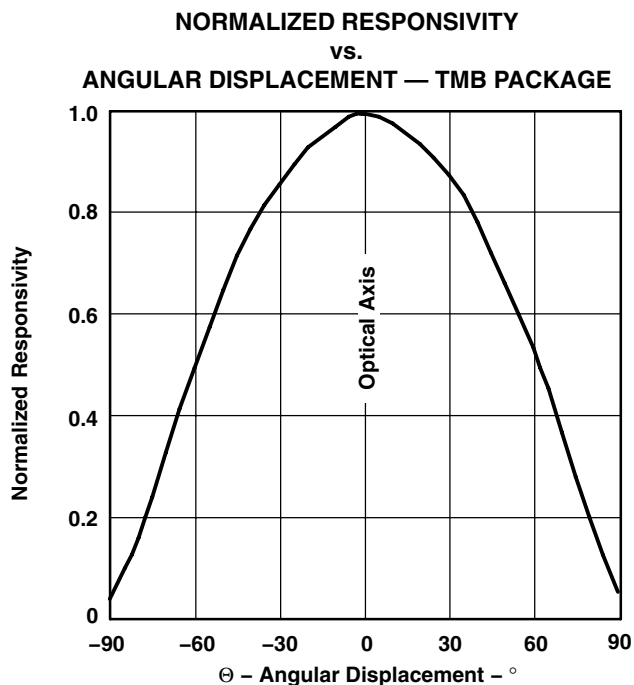

Figure 6

## PRINCIPLES OF OPERATION

### Analog-to-Digital Converter

The TSL256x contains two integrating analog-to-digital converters (ADC) that integrate the currents from the channel 0 and channel 1 photodiodes. Integration of both channels occurs simultaneously, and upon completion of the conversion cycle the conversion result is transferred to the channel 0 and channel 1 data registers, respectively. The transfers are double buffered to ensure that invalid data is not read during the transfer. After the transfer, the device automatically begins the next integration cycle.

### Digital Interface

Interface and control of the TSL256x is accomplished through a two-wire serial interface to a set of registers that provide access to device control functions and output data. The serial interface is compatible with System Management Bus (SMBus) versions 1.1 and 2.0, and I<sup>2</sup>C bus Fast-Mode. The TSL256x offers three slave addresses that are selectable via an external pin (ADDR SEL). The slave address options are shown in Table 1.

Table 1. Slave Address Selection

ADDR SEL TERMINAL LEVEL	SLAVE ADDRESS	SMB ALERT ADDRESS
GND	0101001	0001100
Float	0111001	0001100
VDD	1001001	0001100

NOTE: The Slave and SMB Alert Addresses are 7 bits. Please note the SMBus and I<sup>2</sup>C protocols on pages 9 through 12. A read/write bit should be appended to the slave address by the master device to properly communicate with the TSL256X device.

### SMBus and I<sup>2</sup>C Protocols

Each *Send* and *Write* protocol is, essentially, a series of bytes. A byte sent to the TSL256x with the most significant bit (MSB) equal to 1 will be interpreted as a COMMAND byte. The lower four bits of the COMMAND byte form the register select address (see Table 2), which is used to select the destination for the subsequent byte(s) received. The TSL256x responds to any Receive Byte requests with the contents of the register specified by the stored register select address.

The TSL256X implements the following protocols of the SMB 2.0 specification:

- Send Byte Protocol
- Receive Byte Protocol
- Write Byte Protocol
- Write Word Protocol
- Read Word Protocol
- Block Write Protocol
- Block Read Protocol

The TSL256X implements the following protocols of the Philips Semiconductor I<sup>2</sup>C specification:

- I<sup>2</sup>C Write Protocol
- I<sup>2</sup>C Read (Combined Format) Protocol



When an SMBus Block Write or Block Read is initiated (see description of COMMAND Register), the byte following the COMMAND byte is ignored but is a requirement of the SMBus specification. This field contains the byte count (i.e. the number of bytes to be transferred). The TSL2568 (SMBus) device ignores this field and extracts this information by counting the actual number of bytes transferred before the Stop condition is detected.

When an I<sup>2</sup>C Write or I<sup>2</sup>C Read (Combined Format) is initiated, the byte count is also ignored but follows the SMBus protocol specification. Data bytes continue to be transferred from the TSL2569 (I<sup>2</sup>C) device to Master until a NACK is sent by the Master.

The data formats supported by the TSL2568 and TSL2569 devices are:

- Master transmitter transmits to slave receiver (SMBus and I<sup>2</sup>C):
  - The transfer direction in this case is not changed.
- Master reads slave immediately after the first byte (SMBus only):
  - At the moment of the first acknowledgment (provided by the slave receiver) the master transmitter becomes a master receiver and the slave receiver becomes a slave transmitter.
- Combined format (SMBus and I<sup>2</sup>C):
  - During a change of direction within a transfer, the master repeats both a START condition and the slave address but with the R/W bit reversed. In this case, the master receiver terminates the transfer by generating a NACK on the last byte of the transfer and a STOP condition.

For a complete description of SMBus protocols, please review the SMBus Specification at <http://www.smbus.org/specs>. For a complete description of I<sup>2</sup>C protocols, please review the I<sup>2</sup>C Specification at <http://www.semiconductors.philips.com>.

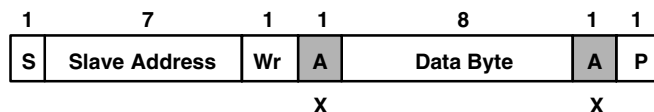

- A** Acknowledge (this bit position may be 0 for an ACK or 1 for a NACK)
- P** Stop Condition
- Rd** Read (bit value of 1)
- S** Start Condition
- Sr** Repeated Start Condition
- Wr** Write (bit value of 0)
- X** Shown under a field indicates that that field is required to have a value of X
- ... Continuation of protocol
- Master-to-Slave
- Slave-to-Master

**Figure 7. SMBus and I<sup>2</sup>C Packet Protocol Element Key**

# TSL2568, TSL2569 LIGHT-TO-DIGITAL CONVERTER

TAOS091D – DECEMBER 2008

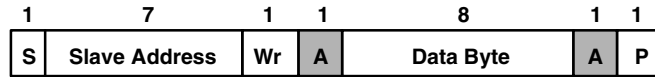

Figure 8. SMBus Send Byte Protocol

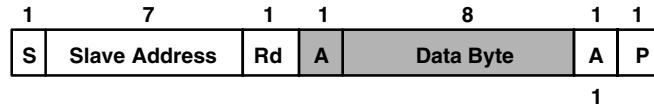

Figure 9. SMBus Receive Byte Protocol

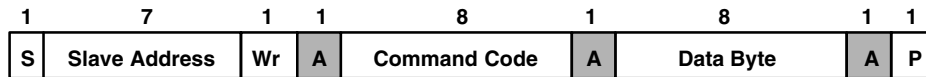

Figure 10. SMBus Write Byte Protocol

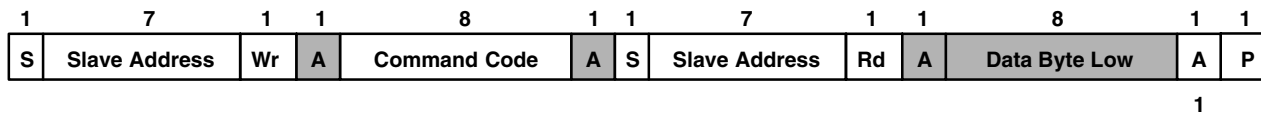

Figure 11. SMBus Read Byte Protocol

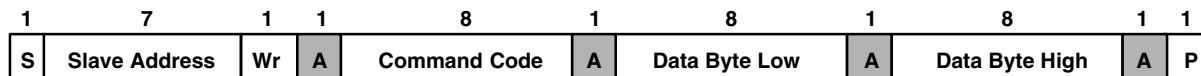

Figure 12. SMBus Write Word Protocol

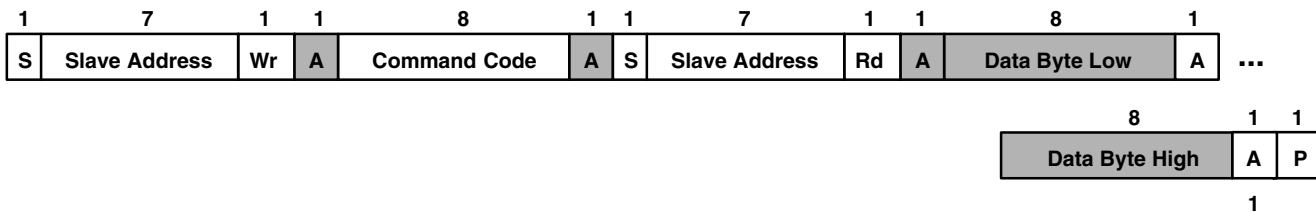

Figure 13. SMBus Read Word Protocol

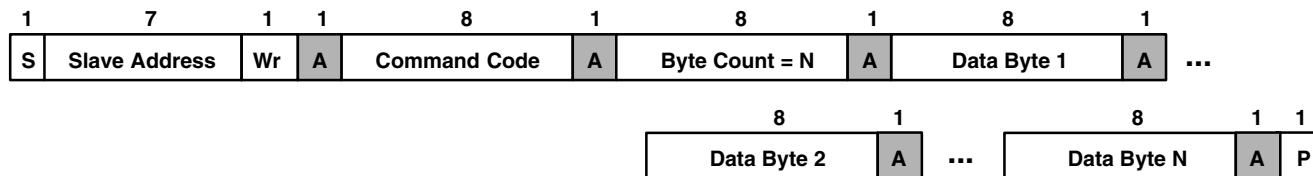

Figure 14. SMBus Block Write or I<sup>2</sup>C Write Protocols

NOTE: The I<sup>2</sup>C write protocol does not use the Byte Count packet, and the Master will continue sending Data Bytes until the Master initiates a Stop condition. See the Command Register on page 13 for additional information regarding the Block Read/Write protocol.

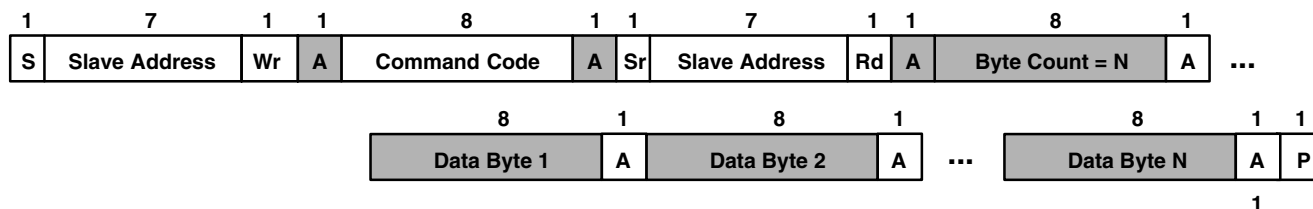

Figure 15. SMBus Block Read or I<sup>2</sup>C Read (Combined Format) Protocols

NOTE: The I<sup>2</sup>C read protocol does not use the Byte Count packet, and the Master will continue receiving Data Bytes until the Master initiates a Stop Condition. See the Command Register on page 13 for additional information regarding the Block Read/Write protocol.

## Register Set

The TSL256x is controlled and monitored by sixteen registers (three are reserved) and a command register accessed through the serial interface. These registers provide for a variety of control functions and can be read to determine results of the ADC conversions. The register set is summarized in Table 2.

Table 2. Register Address

ADDRESS	REGISTER NAME	REGISTER FUNCTION
--	COMMAND	Specifies register address
0h	CONTROL	Control of basic functions
1h	TIMING	Integration time/gain control
2h	THRESHLOWLOW	Low byte of low interrupt threshold
3h	THRESHLOWHIGH	High byte of low interrupt threshold
4h	THRESHHIGHLOW	Low byte of high interrupt threshold
5h	THRESHHIGHHIGH	High byte of high interrupt threshold
6h	INTERRUPT	Interrupt control
7h	--	Reserved
8h	CRC	Factory test — not a user register
9h	--	Reserved
Ah	ID	Part number/ Rev ID
Bh	--	Reserved
Ch	DATA0LOW	Low byte of ADC channel 0
Dh	DATA0HIGH	High byte of ADC channel 0
Eh	DATA1LOW	Low byte of ADC channel 1
Fh	DATA1HIGH	High byte of ADC channel 1

The mechanics of accessing a specific register depends on the specific SMB protocol used. Refer to the section on SMBus protocols. In general, the COMMAND register is written first to specify the specific control/status register for following read/write operations.

# TSL2568, TSL2569 LIGHT-TO-DIGITAL CONVERTER

TAOS091D – DECEMBER 2008

## Command Register

The command register specifies the address of the target register for subsequent read and write operations. The Send Byte protocol is used to configure the COMMAND register. The command register contains eight bits as described in Table 3. The command register defaults to 00h at power on.

**Table 3. Command Register**

	7	6	5	4	3	2	1	0	
	CMD	CLEAR	WORD	BLOCK	ADDRESS				COMMAND
Reset Value:	0	0	0	0	0	0	0	0	
FIELD	BIT	DESCRIPTION							
CMD	7	Select command register. Must write as 1.							
CLEAR	6	Interrupt clear. Clears any pending interrupt. This bit is a write-one-to-clear bit. It is self clearing.							
WORD	5	SMB Write/Read Word Protocol. 1 indicates that this SMB transaction is using either the SMB Write Word or Read Word protocol.							
BLOCK	4	Block Write/Read Protocol. 1 indicates that this transaction is using either the Block Write or the Block Read protocol. See Note below.							
ADDRESS	3:0	Register Address. This field selects the specific control or status register for following write and read commands according to Table 2.							

NOTE: An I<sup>2</sup>C block transaction will continue until the Master sends a stop condition. See Figure 14 and Figure 15. Unlike the I<sup>2</sup>C protocol, the SMBus read/write protocol requires a Byte Count. All four ADC Channel Data Registers (Ch through Fh) can be read simultaneously in a single SMBus transaction. This is the only 32-bit data block supported by the TSL2568 SMBus protocol. The BLOCK bit must be set to 1, and a read condition should be initiated with a COMMAND CODE of 9Bh. By using a COMMAND CODE of 9Bh during an SMBus Block Read Protocol, the TSL2568 device will automatically insert the appropriate Byte Count (Byte Count = 4) as illustrated in Figure 15. A write condition should not be used in conjunction with the Bh register.

## Control Register (0h)

The CONTROL register contains two bits and is primarily used to power the TSL256x device up and down as shown in Table 4.

**Table 4. Control Register**

	7	6	5	4	3	2	1	0	
0h	Resv	Resv	Resv	Resv	Resv	Resv	POWER		CONTROL
Reset Value:	0	0	0	0	0	0	0	0	
FIELD	BIT	DESCRIPTION							
Resv	7:2	Reserved. Write as 0.							
POWER	1:0	Power up/power down. By writing a 03h to this register, the device is powered up. By writing a 00h to this register, the device is powered down. <b>NOTE:</b> If a value of 03h is written, the value returned during a read cycle will be 03h. This feature can be used to verify that the device is communicating properly.							

## Timing Register (1h)

The TIMING register controls both the integration time and the gain of the ADC channels. A common set of control bits is provided that controls both ADC channels. The TIMING register defaults to 02h at power on.

**Table 5. Timing Register**

	7	6	5	4	3	2	1	0	
1h	Resv	Resv	Resv	GAIN	Manual	Resv	INTEG		TIMING
Reset Value:	0	0	0	0	0	0	1	0	
FIELD	BIT	DESCRIPTION							
Resv	7–5	Reserved. Write as 0.							
GAIN	4	Switches gain between low gain and high gain modes. Writing a 0 selects low gain (1×); writing a 1 selects high gain (16×).							
Manual	3	Manual timing control. Writing a 1 begins an integration cycle. Writing a 0 stops an integration cycle. <b>NOTE:</b> This field only has meaning when INTEG = 11. It is ignored at all other times.							
Resv	2	Reserved. Write as 0.							
INTEG	1:0	Integrate time. This field selects the integration time for each conversion.							

Integration time is dependent on the INTEG FIELD VALUE and the internal clock frequency. Nominal integration times and respective scaling between integration times scale proportionally as shown in Table 6. See Note 5 and Note 6 on page 5 for detailed information regarding how the scale values were obtained; see page 22 for further information on how to calculate lux.

**Table 6. Integration Time**

INTEG FIELD VALUE	SCALE	NOMINAL INTEGRATION TIME
00	0.034	13.7 ms
01	0.252	101 ms
10	1	402 ms
11	--	N/A

The manual timing control feature is used to manually start and stop the integration time period. If a particular integration time period is required that is not listed in Table 6, then this feature can be used. For example, the manual timing control can be used to synchronize the TSL256x device with an external light source (e.g. LED). A start command to begin integration can be initiated by writing a 1 to this bit field. Correspondingly, the integration can be stopped by simply writing a 0 to the same bit field.

## Interrupt Threshold Register (2h – 5h)

The interrupt threshold registers store the values to be used as the high and low trigger points for the comparison function for interrupt generation. If the value generated by channel 0 crosses below or is equal to the low threshold specified, an interrupt is asserted on the interrupt pin. If the value generated by channel 0 crosses above the high threshold specified, an interrupt is asserted on the interrupt pin. Registers THRESHLOWLOW and THRESHLOWHIGH provide the low byte and high byte, respectively, of the lower interrupt threshold. Registers THRESHHIGHLOW and THRESHHIGHHIGH provide the low and high bytes, respectively, of the upper interrupt threshold. The high and low bytes from each set of registers are combined to form a 16-bit threshold value. The interrupt threshold registers default to 00h on power up.

# TSL2568, TSL2569 LIGHT-TO-DIGITAL CONVERTER

TAOS091D – DECEMBER 2008

**Table 7. Interrupt Threshold Register**

REGISTER	ADDRESS	BITS	DESCRIPTION
THRESHLOWLOW	2h	7:0	ADC channel 0 lower byte of the low threshold
THRESHLOWHIGH	3h	7:0	ADC channel 0 upper byte of the low threshold
THRESHHIGHLOW	4h	7:0	ADC channel 0 lower byte of the high threshold
THRESHHIGHHIGH	5h	7:0	ADC channel 0 upper byte of the high threshold

NOTE: Since two 8-bit values are combined for a single 16-bit value for each of the high and low interrupt thresholds, the Send Byte protocol should not be used to write to these registers. Any values transferred by the Send Byte protocol with the MSB set would be interpreted as the COMMAND field and stored as an address for subsequent read/write operations and not as the interrupt threshold information as desired. The Write Word protocol should be used to write byte-paired registers. For example, the THRESHLOWLOW and THRESHLOWHIGH registers (as well as the THRESHHIGHLOW and THRESHHIGHHIGH registers) can be written together to set the 16-bit ADC value in a single transaction.

## Interrupt Control Register (6h)

The INTERRUPT register controls the extensive interrupt capabilities of the TSL256x. The TSL256x permits both SMB-Alert style interrupts as well as traditional level-style interrupts. The interrupt persist bit field (PERSIST) provides control over when interrupts occur. A value of 0 causes an interrupt to occur after every integration cycle regardless of the threshold settings. A value of 1 results in an interrupt after one integration time period outside the threshold window. A value of *N* (where *N* is 2 through 15) results in an interrupt only if the value remains outside the threshold window for *N* consecutive integration cycles. For example, if *N* is equal to 10 and the integration time is 402 ms, then the total time is approximately 4 seconds.

When a level Interrupt is selected, an interrupt is generated whenever the last conversion results in a value outside of the programmed threshold window. The interrupt is active-low and remains asserted until cleared by writing the COMMAND register with the CLEAR bit set.

In SMBAlert mode, the interrupt is similar to the traditional level style and the interrupt line is asserted low. To clear the interrupt, the host responds to the SMBAlert by performing a modified Receive Byte operation, in which the Alert Response Address (ARA) is placed in the slave address field, and the TSL256x that generated the interrupt responds by returning its own address in the seven most significant bits of the receive data byte. If more than one device connected on the bus has pulled the SMBAlert line low, the highest priority (lowest address) device will win communication rights via standard arbitration during the slave address transfer. If the device loses this arbitration, the interrupt will not be cleared. The Alert Response Address is 0Ch.

When INTR = 11, the interrupt is generated immediately following the SMBus write operation. Operation then behaves in an SMBAlert mode, and the *software set* interrupt may be cleared by an SMBAlert cycle.

NOTE: Interrupts are based on the value of Channel 0 only.

**Table 8. Interrupt Control Register**

	7	6	5	4	3	2	1	0	
6h	Resv	Resv	INTR		PERSIST				INTERRUPT
Reset Value:	0	0	0	0	0	0	0	0	
FIELD	BITS		DESCRIPTION						
Resv	7:6		Reserved. Write as 0.						
INTR	5:4		INTR Control Select. This field determines mode of interrupt logic according to Table 9, below.						
PERSIST	3:0		Interrupt persistence. Controls rate of interrupts to the host processor as shown in Table 10, below.						

**Table 9. Interrupt Control Select**

INTR FIELD VALUE	READ VALUE
00	Interrupt output disabled
01	Level Interrupt
10	SMBAlert compliant
11	Test Mode: Sets interrupt and functions as mode 10

NOTE: Field value of 11 may be used to test interrupt connectivity in a system or to assist in debugging interrupt service routine software.

**Table 10. Interrupt Persistence Select**

PERSIST FIELD VALUE	INTERRUPT PERSIST FUNCTION
0000	Every ADC cycle generates interrupt
0001	Any value outside of threshold range
0010	2 integration time periods out of range
0011	3 integration time periods out of range
0100	4 integration time periods out of range
0101	5 integration time periods out of range
0110	6 integration time periods out of range
0111	7 integration time periods out of range
1000	8 integration time periods out of range
1001	9 integration time periods out of range
1010	10 integration time periods out of range
1011	11 integration time periods out of range
1100	12 integration time periods out of range
1101	13 integration time periods out of range
1110	14 integration time periods out of range
1111	15 integration time periods out of range

## ID Register (Ah)

The ID register provides the value for both the part number and silicon revision number for that part number. It is a read-only register, whose value never changes.

**Table 11. ID Register**

	7	6	5	4	3	2	1	0	
Ah	PARTNO						REVNO		ID
Reset Value:	-	-	-	-	-	-	-	-	
FIELD	BITS	DESCRIPTION							
PARTNO	7:4	Part Number Identification: field value 1010 = TSL2568, field value 1011 = TSL2569							
REVNO	3:0	Revision number identification							

# TSL2568, TSL2569 LIGHT-TO-DIGITAL CONVERTER

TAOS091D – DECEMBER 2008

---

## ADC Channel Data Registers (Ch – Fh)

The ADC channel data are expressed as 16-bit values spread across two registers. The ADC channel 0 data registers, DATA0LOW and DATA0HIGH provide the lower and upper bytes, respectively, of the ADC value of channel 0. Registers DATA1LOW and DATA1HIGH provide the lower and upper bytes, respectively, of the ADC value of channel 1. All channel data registers are read-only and default to 00h on power up.

**Table 12. ADC Channel Data Registers**

REGISTER	ADDRESS	BITS	DESCRIPTION
DATA0LOW	Ch	7:0	ADC channel 0 lower byte
DATA0HIGH	Dh	7:0	ADC channel 0 upper byte
DATA1LOW	Eh	7:0	ADC channel 1 lower byte
DATA1HIGH	Fh	7:0	ADC channel 1 upper byte

The upper byte data registers can only be read following a read to the corresponding lower byte register. When the lower byte register is read, the upper eight bits are strobed into a shadow register, which is read by a subsequent read to the upper byte. The upper register will read the correct value even if additional ADC integration cycles end between the reading of the lower and upper registers.

NOTE: The Read Word protocol can be used to read byte-paired registers. For example, the DATA0LOW and DATA0HIGH registers (as well as the DATA1LOW and DATA1HIGH registers) may be read together to obtain the 16-bit ADC value in a single transaction



## APPLICATION INFORMATION: SOFTWARE

### Basic Operation

After applying  $V_{DD}$ , the device will initially be in the power-down state. To operate the device, issue a command to access the CONTROL register followed by the data value 03h to power up the device. At this point, both ADC channels will begin a conversion at the default integration time of 400 ms. After 400 ms, the conversion results will be available in the DATA0 and DATA1 registers. Use the following pseudo code to read the data registers:

```
// Read ADC Channels Using Read Word Protocol - RECOMMENDED
    Address = 0x39                                //Slave addr - also 0x29 or 0x49

    //Address the Ch0 lower data register and configure for Read Word
    Command = 0xAC                                //Set Command bit and Word bit

    //Reads two bytes from sequential registers 0x0C and 0x0D
    //Results are returned in DataLow and DataHigh variables
    ReadWord (Address, Command, DataLow, DataHigh)
    Channel0 = 256 * DataHigh + DataLow

    //Address the Ch1 lower data register and configure for Read Word
    Command = 0xAE                                //Set bit fields 7 and 5

    //Reads two bytes from sequential registers 0x0E and 0x0F
    //Results are returned in DataLow and DataHigh variables
    ReadWord (Address, Command, DataLow, DataHigh)
    Channel1 = 256 * DataHigh + DataLow           //Shift DataHigh to upper byte

// Read ADC Channels Using Read Byte Protocol
    Address = 0x39                                //Slave addr - also 0x29 or 0x49
    Command = 0x8C                                //Address the Ch0 lower data register
    ReadByte (Address, Command, DataLow)           //Result returned in DataLow
    Command = 0x8D                                //Address the Ch0 upper data register
    ReadByte (Address, Command, DataHigh)         //Result returned in DataHigh
    Channel0 = 256 * DataHigh + DataLow           //Shift DataHigh to upper byte

    Command = 0x8E                                //Address the Ch1 lower data register
    ReadByte (Address, Command, DataLow)           //Result returned in DataLow
    Command = 0x8F                                //Address the Ch1 upper data register
    ReadByte (Address, Command, DataHigh)         //Result returned in DataHigh
    Channel1 = 256 * DataHigh + DataLow           //Shift DataHigh to upper byte
```

# TSL2568, TSL2569 LIGHT-TO-DIGITAL CONVERTER

TAOS091D – DECEMBER 2008

---

## APPLICATION INFORMATION: SOFTWARE

### Configuring the Timing Register

The command, timing, and control registers are initialized to default values on power up. Setting these registers to the desired values would be part of a normal initialization or setup procedure. In addition, to maximize the performance of the device under various conditions, the integration time and gain may be changed often during operation. The following pseudo code illustrates a procedure for setting up the timing register for various options:

```
// Set up Timing Register
//Low Gain (1x), integration time of 402ms (default value)
Address = 0x39
Command = 0x81
Data = 0x02
WriteByte(Address, Command, Data)

//Low Gain (1x), integration time of 101ms
Data = 0x01
WriteByte(Address, Command, Data)

//Low Gain (1x), integration time of 13.7ms
Data = 0x00
WriteByte(Address, Command, Data)

//High Gain (16x), integration time of 101ms
Data = 0x11
WriteByte(Address, Command, Data)

//Read data registers (see Basic Operation example)

//Perform Manual Integration
//Set up for manual integration with Gain of 1x
Data = 0x03
//Set manual integration mode - device stops converting
WriteByte(Address, Command, Data)

//Begin integration period
Data = 0x0B
WriteByte(Address, Command, Data)

//Integrate for 50ms
Sleep (50) //Wait for 50ms

//Stop integrating
Data = 0x03
WriteByte(Address, Command, Data)

//Read data registers (see Basic Operation example)
```

**APPLICATION INFORMATION: SOFTWARE**

**Interrupts**

The interrupt feature of the TSL256x device simplifies and improves system efficiency by eliminating the need to poll the sensor for a light intensity value. Interrupt styles are determined by the INTR field in the Interrupt Register. The interrupt feature may be disabled by writing a field value of 00h to the Interrupt Control Register so that polling can be performed.

The versatility of the interrupt feature provides many options for interrupt configuration and usage. The primary purpose of the interrupt function is to provide a meaningful change in light intensity. However, it also be used as an end-of-conversion signal. The concept of a *meaningful change* can be defined by the user both in terms of light intensity and time, or persistence, of that change in intensity. The TSL256x device implements two 16-bit-wide interrupt threshold registers that allow the user to define a threshold above and below the current light level. An interrupt will then be generated when the value of a conversion exceeds either of these limits. For simplicity of programming, the threshold comparison is accomplished only with Channel 0. This simplifies calculation of thresholds that are based, for example, on a percent of the current light level. It is adequate to use only one channel when calculating light intensity differences since, for a given light source, the channel 0 and channel 1 values are linearly proportional to each other and thus both values scale linearly with light intensity.

To further control when an interrupt occurs, the TSL256x device provides an interrupt persistence feature. This feature allows the user to specify a number of conversion cycles for which a light intensity exceeding either interrupt threshold must persist before actually generating an interrupt. This can be used to prevent transient changes in light intensity from generating an unwanted interrupt. With a value of 1, an interrupt occurs immediately whenever either threshold is exceeded. With values of *N*, where *N* can range from 2 to 15, *N* consecutive conversions must result in values outside the interrupt window for an interrupt to be generated. For example, if *N* is equal to 10 and the integration time is 402 ms, then an interrupt will not be generated unless the light level persists for more than 4 seconds outside the threshold.

Two different interrupt styles are available: Level and SMBus Alert. The difference between these two interrupt styles is how they are cleared. Both result in the interrupt line going active low and remaining low until the interrupt is cleared. A level style interrupt is cleared by setting the CLEAR bit (bit 6) in the COMMAND register. The SMBus Alert style interrupt is cleared by an Alert Response as described in the Interrupt Control Register section and SMBus specification.

To configure the interrupt as an end-of-conversion signal, the interrupt PERSIST field is set to 0. Either Level or SMBus Alert style can be used. An interrupt will be generated upon completion of each conversion. The interrupt threshold registers are ignored. The following example illustrates the configuration of a level interrupt:

```
// Set up end-of-conversion interrupt, Level style
Address = 0x39 //Slave addr also 0x29 or 0x49
Command = 0x86 //Address Interrupt Register
Data = 0x10 //Level style, every ADC cycle
WriteByte(Address, Command, Data)
```

# TSL2568, TSL2569 LIGHT-TO-DIGITAL CONVERTER

TAOS091D – DECEMBER 2008

---

## APPLICATION INFORMATION: SOFTWARE

The following example pseudo code illustrates the configuration of an SMB Alert style interrupt when the light intensity changes 20% from the current value, and persists for 3 conversion cycles:

```
// Read current light level
Address = 0x39 //Slave addr also 0x29 or 0x49
Command = 0xAC //Set Command bit and Word bit
ReadWord (Address, Command, DataLow, DataHigh)
Channel0 = (256 * DataHigh) + DataLow

//Calculate upper and lower thresholds
T_Upper = Channel0 + (0.2 * Channel0)
T_Lower = Channel0 - (0.2 * Channel0)

//Write the lower threshold register
Command = 0xA2 //Addr lower threshold reg, set Word Bit
WriteWord (Address, Command, T_Lower.LoByte, T_Lower.HiByte)

//Write the upper threshold register
Command = 0xA4 //Addr upper threshold reg, set Word bit
WriteWord (Address, Command, T_Upper.LoByte, T_Upper.HiByte)

//Enable interrupt
Command = 0x86 //Address interrupt register
Data = 0x23 //SMBAlert style, PERSIST = 3
WriteByte(Address, Command, Data)
```

In order to generate an interrupt on demand during system test or debug, a test mode (INTR = 11) can be used. The following example illustrates how to generate an interrupt on demand:

```
// Generate an interrupt
Address = 0x39 //Slave addr also 0x29 or 0x49
Command = 0x86 //Address Interrupt register
Data = 0x30 //Test interrupt
WriteByte(Address, Command, Data)

//Interrupt line should now be low
```

**APPLICATION INFORMATION: SOFTWARE**

**Calculating Lux**

The TSL256x is intended for use in ambient light detection applications such as display backlight control, where adjustments are made to display brightness or contrast based on the brightness of the ambient light, as perceived by the human eye. Conventional silicon detectors respond strongly to infrared light, which the human eye does not see. This can lead to significant error when the infrared content of the ambient light is high, such as with incandescent lighting, due to the difference between the silicon detector response and the brightness perceived by the human eye.

This problem is overcome in the TSL256x through the use of two photodiodes. One of the photodiodes (channel 0) is sensitive to both visible and infrared light, while the second photodiode (channel 1) is sensitive primarily to infrared light. An integrating ADC converts the photodiode currents to digital outputs. Channel 1 digital output is used to compensate for the effect of the infrared component of light on the channel 0 digital output. The ADC digital outputs from the two channels are used in a formula to obtain a value that approximates the human eye response in the commonly used Illuminance unit of Lux:

**Chipscale Package**

For $0 < CH1/CH0 \leq 0.35$	$Lux = 0.00713 \times CH0 - 0.00975 \times CH1$
For $0.35 < CH1/CH0 \leq 0.45$	$Lux = 0.00813 \times CH0 - 0.01250 \times CH1$
For $0.45 < CH1/CH0 \leq 0.52$	$Lux = 0.00935 \times CH0 - 0.01521 \times CH1$
For $0.52 < CH1/CH0 \leq 0.67$	$Lux = 0.00394 \times CH0 - 0.00482 \times CH1$
For $0.67 < CH1/CH0 \leq 0.85$	$Lux = 0.00337 \times CH0 - 0.00396 \times CH1$
For $CH1/CH0 > 0.85$	$Lux = 0$

**TMB Package**

For $0 < CH1/CH0 \leq 0.35$	$Lux = 0.00763 \times CH0 - 0.01031 \times CH1$
For $0.35 < CH1/CH0 \leq 0.50$	$Lux = 0.00817 \times CH0 - 0.01188 \times CH1$
For $0.50 < CH1/CH0 \leq 0.60$	$Lux = 0.00723 \times CH0 - 0.01000 \times CH1$
For $0.60 < CH1/CH0 \leq 0.72$	$Lux = 0.00573 \times CH0 - 0.00750 \times CH1$
For $0.72 < CH1/CH0 \leq 0.85$	$Lux = 0.00216 \times CH0 - 0.00254 \times CH1$
For $CH1/CH0 > 0.85$	$Lux = 0$

The formulas shown above were obtained by optical testing with fluorescent and incandescent light sources, and apply only to open-air applications. Optical apertures (e.g. light pipes) will affect the incident light on the device.

**Simplified Lux Calculation**

Below is the argument and return value including source code (shown on following page) for calculating lux. The source code is intended for embedded and/or microcontroller applications. Two individual code sets are provided, one for the chipscale package and one for the TMB package. All floating point arithmetic operations have been eliminated since embedded controllers and microcontrollers generally do not support these types of operations. Since floating point has been removed, scaling must be performed prior to calculating illuminance if the integration time is not 402 ms and/or if the gain is not 16x as denoted in the source code on the following pages. This sequence scales first to mitigate rounding errors induced by decimal math.

```
extern unsigned int CalculateLux(unsigned int iGain, unsigned int tInt, unsigned int
    ch0, unsigned int ch1, int iType)
```

# TSL2568, TSL2569 LIGHT-TO-DIGITAL CONVERTER

TAOS091D – DECEMBER 2008

---

```
//*****  
//  
// Copyright 2004-2008 TAOS, Inc.  
//  
// THIS CODE AND INFORMATION IS PROVIDED "AS IS" WITHOUT WARRANTY OF ANY  
// KIND, EITHER EXPRESSED OR IMPLIED, INCLUDING BUT NOT LIMITED TO THE  
// IMPLIED WARRANTIES OF MERCHANTABILITY AND/OR FITNESS FOR A PARTICULAR  
// PURPOSE.  
//  
// Module Name:  
// lux.cpp  
//  
//*****  
  
#define LUX_SCALE 16          // scale by 2^16  
#define RATIO_SCALE 9       // scale ratio by 2^9  
  
//-----  
// Integration time scaling factors  
//-----  
  
#define CH_SCALE 10          // scale channel values by 2^10  
#define CHSCALE_TINT0 0x7517 // 322/11 * 2^CH_SCALE  
#define CHSCALE_TINT1 0x0fe7 // 322/81 * 2^CH_SCALE  
  
//-----  
// T Package coefficients  
//-----  
// For Ch1/Ch0=0.00 to 0.35:  
//      Lux=0.00763*Ch0-0.01031*Ch1  
//  
// For Ch1/Ch0=0.35 to 0.50:  
//      Lux=0.00817*Ch0-0.01188*Ch1  
//  
// For Ch1/Ch0=0.50 to 0.60:  
//      Lux=0.00723*Ch0-0.01000*Ch1  
//  
// For Ch1/Ch0=0.60 to 0.72:  
//      Lux=0.00573*Ch0-0.00750*Ch1  
//  
// For Ch1/Ch0=0.72 to 0.85:  
//      Lux=0.00216*Ch0-0.00254*Ch1  
//  
// For Ch1/Ch0>0.85:  
//      Lux/Ch0=0  
//  
//-----  
#define K1T 0x00b3          // 0.35 * 2^RATIO_SCALE  
#define B1T 0x01f4          // 0.00763 * 2^LUX_SCALE  
#define M1T 0x02a4          // 0.01031 * 2^LUX_SCALE  
  
#define K2T 0x0100          // 0.50 * 2^RATIO_SCALE  
#define B2T 0x0217          // 0.00817 * 2^LUX_SCALE  
#define M2T 0x030a          // 0.01188 * 2^LUX_SCALE  
  
#define K3T 0x0133          // 0.60 * 2^RATIO_SCALE  
#define B3T 0x01da          // 0.00723 * 2^LUX_SCALE  
#define M3T 0x028f          // 0.01000 * 2^LUX_SCALE
```



```

#define K4T 0x0171          // 0.72 * 2^RATIO_SCALE
#define B4T 0x0177          // 0.00573 * 2^LUX_SCALE
#define M4T 0x01ec          // 0.00750 * 2^LUX_SCALE

#define K5T 0x01b3          // 0.85 * 2^RATIO_SCALE
#define B5T 0x008d          // 0.00216 * 2^LUX_SCALE
#define M5T 0x00a6          // 0.00254 * 2^LUX_SCALE

#define K6T 0x01b3          // 0.85 * 2^RATIO_SCALE
#define B6T 0x0000          // 0.00000 * 2^LUX_SCALE
#define M6T 0x0000          // 0.00000 * 2^LUX_SCALE

//-----
// CS Package coefficients
//-----
// For Ch1/Ch0=0.00 to 0.35:
//      Lux=0.00713*Ch0-0.00975*Ch1
//
// For Ch1/Ch0=0.35 to 0.45:
//      Lux=0.00813*Ch0-0.01250*Ch1
//
// For Ch1/Ch0=0.45 to 0.52:
//      Lux=0.00935*Ch0-0.01521*Ch1
//
// For Ch1/Ch0=0.52 to 0.67:
//      Lux=0.00394*Ch0-0.00482*Ch1
//
// For Ch1/Ch0=0.67 to 0.85:
//      Lux=0.00337*Ch0-0.00396*Ch1
//
// For Ch1/Ch0>0.85:
//      Lux/Ch0=0
//-----
#define K1C 0x00b3          // 0.35 * 2^RATIO_SCALE
#define B1C 0x01d3          // 0.00713 * 2^LUX_SCALE
#define M1C 0x027f          // 0.00975 * 2^LUX_SCALE

#define K2C 0x00e6          // 0.45 * 2^RATIO_SCALE
#define B2C 0x0214          // 0.00813 * 2^LUX_SCALE
#define M2C 0x0333          // 0.01250 * 2^LUX_SCALE

#define K3C 0x010a          // 0.52 * 2^RATIO_SCALE
#define B3C 0x0265          // 0.00935 * 2^LUX_SCALE
#define M3C 0x03e5          // 0.01521 * 2^LUX_SCALE

#define K4C 0x0157          // 0.67 * 2^RATIO_SCALE
#define B4C 0x0102          // 0.00394 * 2^LUX_SCALE
#define M4C 0x013c          // 0.00482 * 2^LUX_SCALE

#define K5C 0x01b3          // 0.85 * 2^RATIO_SCALE
#define B5C 0x00dd          // 0.00337 * 2^LUX_SCALE
#define M5C 0x0104          // 0.00396 * 2^LUX_SCALE

#define K6C 0x01b3          // 0.85 * 2^RATIO_SCALE
#define B6C 0x0000          // 0.00000 * 2^LUX_SCALE
#define M6C 0x0000          // 0.00000 * 2^LUX_SCALE

```



# TSL2568, TSL2569 LIGHT-TO-DIGITAL CONVERTER

TAOS091D – DECEMBER 2008

---

```
// lux equation approximation without floating point calculations
// Routine: unsigned int CalculateLux(unsigned int ch0, unsigned int ch1, int iType)
// Description: Calculate the approximate illuminance (lux) given the raw
//              channel values of the TSL2568. The equation is implemented
//              as a piece-wise linear approximation.
// Arguments: unsigned int iGain - gain, where 0:1X, 1:16X
//            unsigned int tInt - integration time, where 0:13.7mS, 1:100mS, 2:402mS,
//            3:Manual
//            unsigned int ch0 - raw channel value from channel 0 of TSL2568
//            unsigned int ch1 - raw channel value from channel 1 of TSL2568
//            unsigned int iType - package type (0:T, 1:CS)
// Return:    unsigned int - the approximate illuminance (lux)
//
// unsigned int CalculateLux(unsigned int iGain, unsigned int tInt, unsigned int ch0,
// unsigned int ch1, int iType)
{
    //-----
    // first, scale the channel values depending on the gain and integration time
    // 16X, 402mS is nominal.
    // scale if integration time is NOT 402 msec
    unsigned long chScale;
    unsigned long channel1;
    unsigned long channel0;
    switch (tInt)
    {
        case 0: // 13.7 msec
            chScale = CHSCALE_TINT0;
            break;
        case 1: // 101 msec
            chScale = CHSCALE_TINT1;
            break;
        default: // assume no scaling
            chScale = (1 << CH_SCALE);
            break;
    }
    // scale if gain is NOT 16X
    if (!iGain) chScale = chScale << 4; // scale 1X to 16X

    // scale the channel values
    channel0 = (ch0 * chScale) >> CH_SCALE;
    channel1 = (ch1 * chScale) >> CH_SCALE;
    //-----

    // find the ratio of the channel values (Channel1/Channel0)
    // protect against divide by zero
    unsigned long ratio1 = 0;
    if (channel0 != 0) ratio1 = (channel1 << (RATIO_SCALE+1)) / channel0;
    // round the ratio value
    unsigned long ratio = (ratio1 + 1) >> 1;

    // is ratio <= eachBreak ?
    unsigned int b, m;
```





```

switch (iType)
{
    case 0: // T package
        if ((ratio >= 0) && (ratio <= K1T))
            {b=B1T; m=M1T;}
        else if (ratio <= K2T)
            {b=B2T; m=M2T;}
        else if (ratio <= K3T)
            {b=B3T; m=M3T;}
        else if (ratio <= K4T)
            {b=B4T; m=M4T;}
        else if (ratio <= K5T)
            {b=B5T; m=M5T;}
        else if (ratio > K6T)
            {b=B6T; m=M6T;}
        break;

    case 1: // CS package
        if ((ratio >= 0) && (ratio <= K1C))
            {b=B1C; m=M1C;}
        else if (ratio <= K2C)
            {b=B2C; m=M2C;}
        else if (ratio <= K3C)
            {b=B3C; m=M3C;}
        else if (ratio <= K4C)
            {b=B4C; m=M4C;}
        else if (ratio <= K5C)
            {b=B5C; m=M5C;}
        else if (ratio > K6C)
            {b=B6C; m=M6C;}
        break;
}

unsigned long temp;
unsigned long lux;
temp = ((channel0 * b) - (channel1 * m));

// scale CS or T package
// round lsb (2^(LUX_SCALE-1))
temp += (1 << (LUX_SCALE-1));
// strip off fractional portion
lux = temp >> LUX_SCALE;

return(lux);
}
    
```

## APPLICATION INFORMATION: HARDWARE

### Power Supply Decoupling and Application Hardware Circuit

The power supply lines must be decoupled with a 0.1  $\mu\text{F}$  capacitor placed as close to the device package as possible (Figure 16). The bypass capacitor should have low effective series resistance (ESR) and low effective series inductance (ESI), such as the common ceramic types, which provide a low impedance path to ground at high frequencies to handle transient currents caused by internal logic switching.

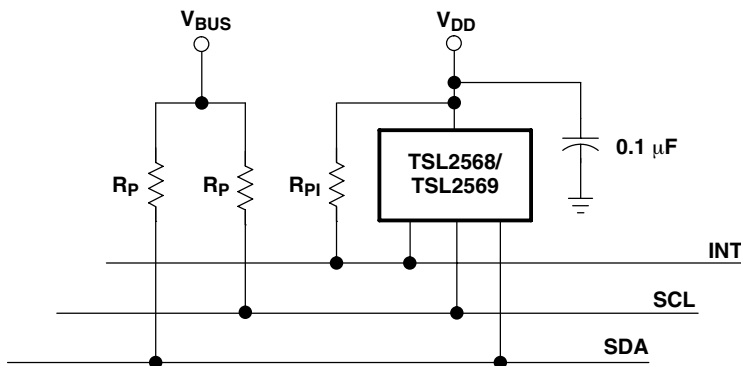

Figure 16. Bus Pull-Up Resistors

Pull-up resistors ( $R_p$ ) maintain the SDAH and SCLH lines at a *high* level when the bus is free and ensure the signals are pulled up from a low to a high level within the required rise time. For a complete description of the SMBus maximum and minimum  $R_p$  values, please review the SMBus Specification at <http://www.smbus.org/specs>. For a complete description of I<sup>2</sup>C maximum and minimum  $R_p$  values, please review the I<sup>2</sup>C Specification at <http://www.semiconductors.philips.com>.

A pull-up resistor ( $R_{PI}$ ) is also required for the interrupt (INT), which functions as a wired-AND signal in a similar fashion to the SCL and SDA lines. A typical impedance value between 10 k $\Omega$  and 100 k $\Omega$  can be used. Please note that while Figure 16 shows INT being pulled up to V<sub>DD</sub>, the interrupt can optionally be pulled up to V<sub>BUS</sub>.

APPLICATION INFORMATION: HARDWARE

PCB Pad Layout

Suggested PCB pad layout guidelines for the TMB-6 surface mount package and CS chipscale package are shown in Figure 17 and Figure 18.

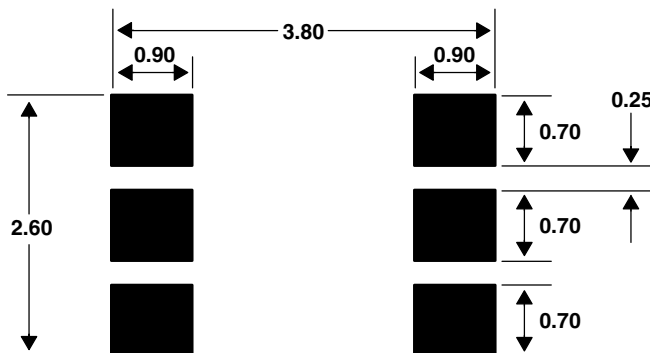

- NOTES: A. All linear dimensions are in millimeters.  
B. This drawing is subject to change without notice.

Figure 17. Suggested TMB-6 Package PCB Layout

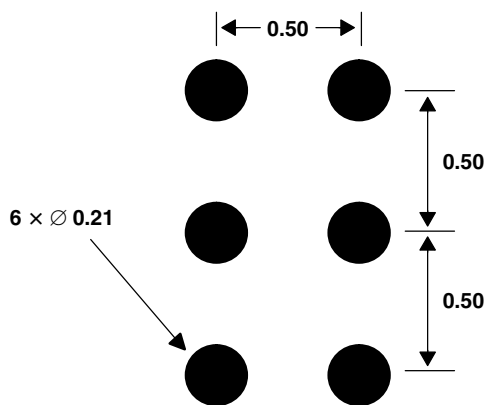

- NOTES: A. All linear dimensions are in millimeters.  
B. This drawing is subject to change without notice.

Figure 18. Suggested Chipscale Package PCB Layout

# TSL2568, TSL2569 LIGHT-TO-DIGITAL CONVERTER

TAOS091D – DECEMBER 2008

## MECHANICAL DATA

PACKAGE CS

Six-Lead Chipscale Device

TOP VIEW

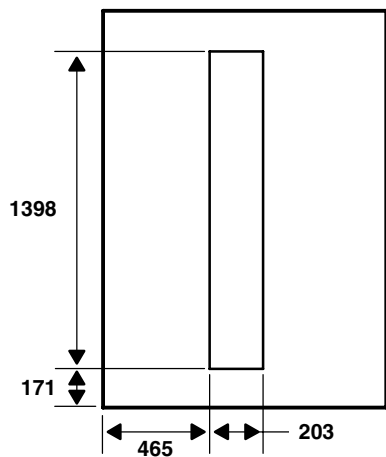

PIN OUT  
BOTTOM VIEW

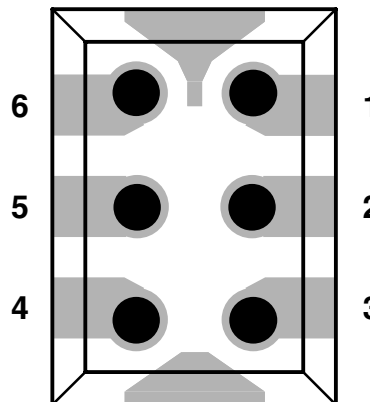

END VIEW

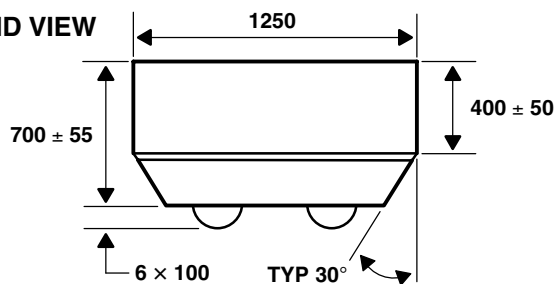

BOTTOM VIEW

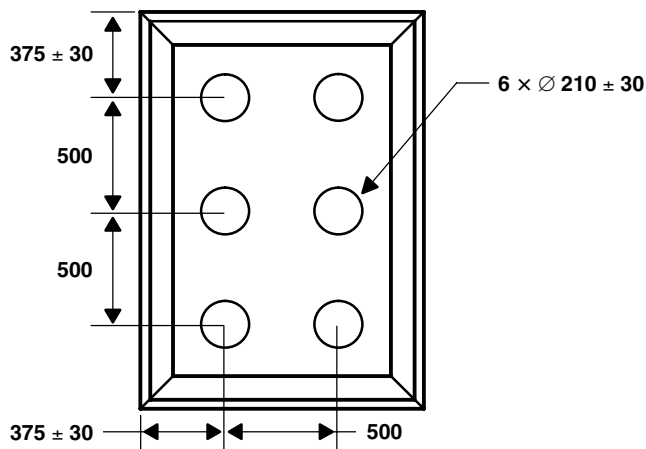

SIDE VIEW

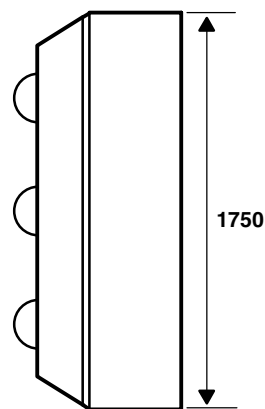

Lead Free

- NOTES: A. All linear dimensions are in micrometers. Dimension tolerance is  $\pm 25 \mu\text{m}$  unless otherwise noted.  
 B. Solder bumps are formed of Sn (96.5%), Ag (3%), and Cu (0.5%).  
 C. The top of the photodiode active area is  $410 \mu\text{m}$  below the top surface of the package.  
 D. The layer above the photodiode is glass and epoxy with an index of refraction of 1.53.  
 E. This drawing is subject to change without notice.

Figure 19. Package CS — Six-Lead Chipscale Packaging Configuration

MECHANICAL DATA

PACKAGE TMB-6

Six-Lead Surface Mount Device

TOP VIEW

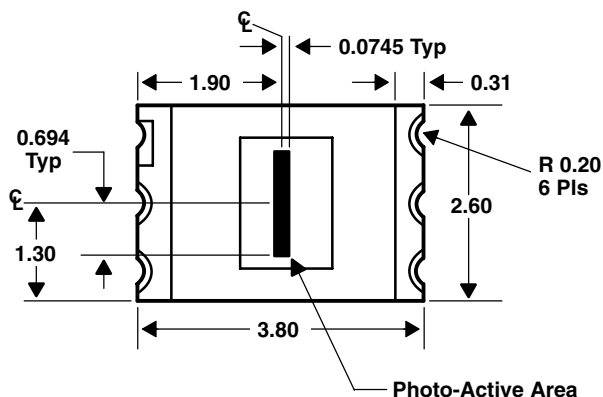

TOP VIEW

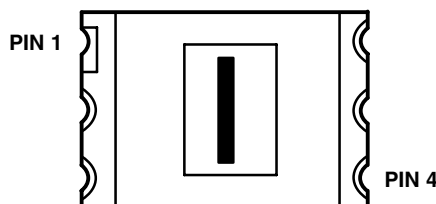

END VIEW

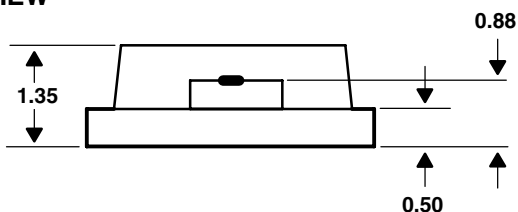

BOTTOM VIEW

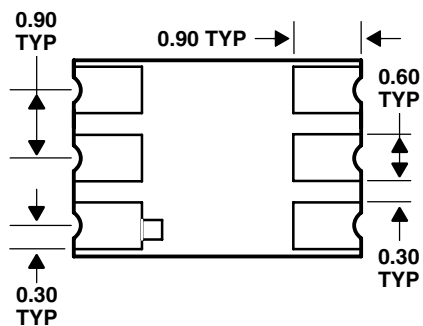

Lead Free

- NOTES: A. All linear dimensions are in millimeters. Dimension tolerance is  $\pm 0.20$  mm unless otherwise noted.  
 B. The photo-active area is  $1388 \mu\text{m}$  by  $149 \mu\text{m}$ .  
 C. Package top surface is molded with an electrically nonconductive clear plastic compound having an index of refraction of 1.55.  
 D. Contact finish is  $0.5 \mu\text{m}$  minimum of soft gold plated over a  $18 \mu\text{m}$  thick copper foil pattern with a  $5 \mu\text{m}$  to  $9 \mu\text{m}$  nickel barrier.  
 E. The underside of the package includes copper traces used to connect the pads during package substrate fabrication. Accordingly, exposed traces and vias should not be placed under the footprint of the TMB package in a PCB layout.  
 F. This package contains no lead (Pb).  
 G. This drawing is subject to change without notice.

Figure 20. Package T — Six-Lead TMB Plastic Surface Mount Packaging Configuration

# TSL2568, TSL2569 LIGHT-TO-DIGITAL CONVERTER

TAOS091D – DECEMBER 2008

## MECHANICAL DATA

### TOP VIEW

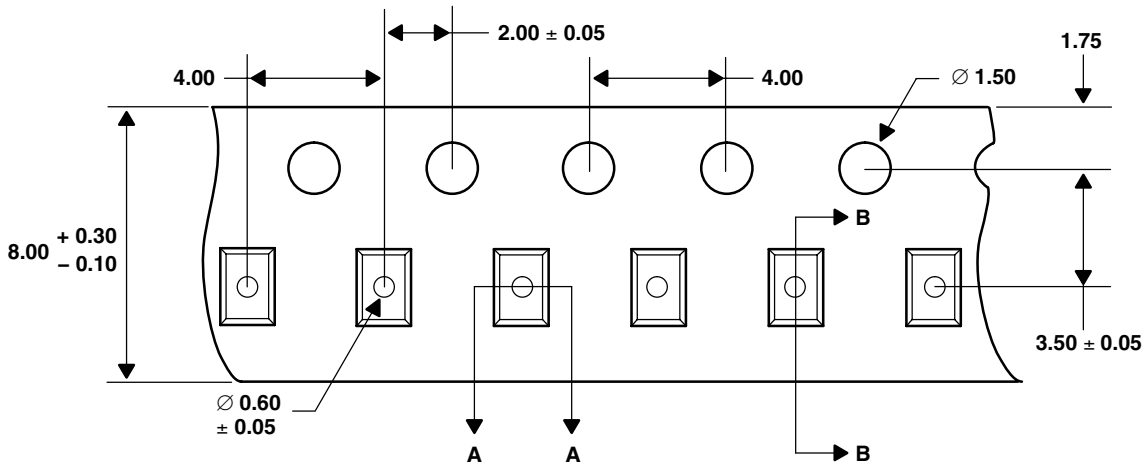

### DETAIL A

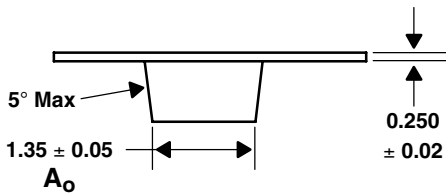

### DETAIL B

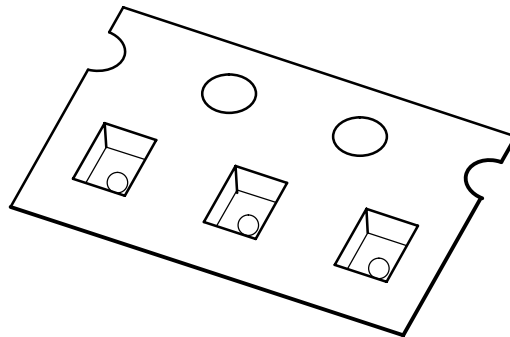
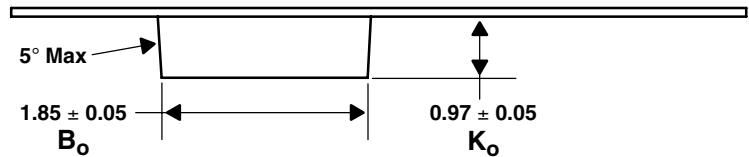

- NOTES: A. All linear dimensions are in millimeters. Dimension tolerance is  $\pm 0.10$  mm unless otherwise noted.  
 B. The dimensions on this drawing are for illustrative purposes only. Dimensions of an actual carrier may vary slightly.  
 C. Symbols on drawing  $A_o$ ,  $B_o$ , and  $K_o$  are defined in ANSI EIA Standard 481-B 2001.  
 D. Each reel is 178 millimeters in diameter and contains 3500 parts.  
 E. TAOS packaging tape and reel conform to the requirements of EIA Standard 481-B.  
 F. In accordance with EIA standard, device pin 1 is located next to the sprocket holes in the tape.  
 G. This drawing is subject to change without notice.

Figure 21. TSL2568/TSL2569 Chipscale Carrier Tape

MECHANICAL DATA

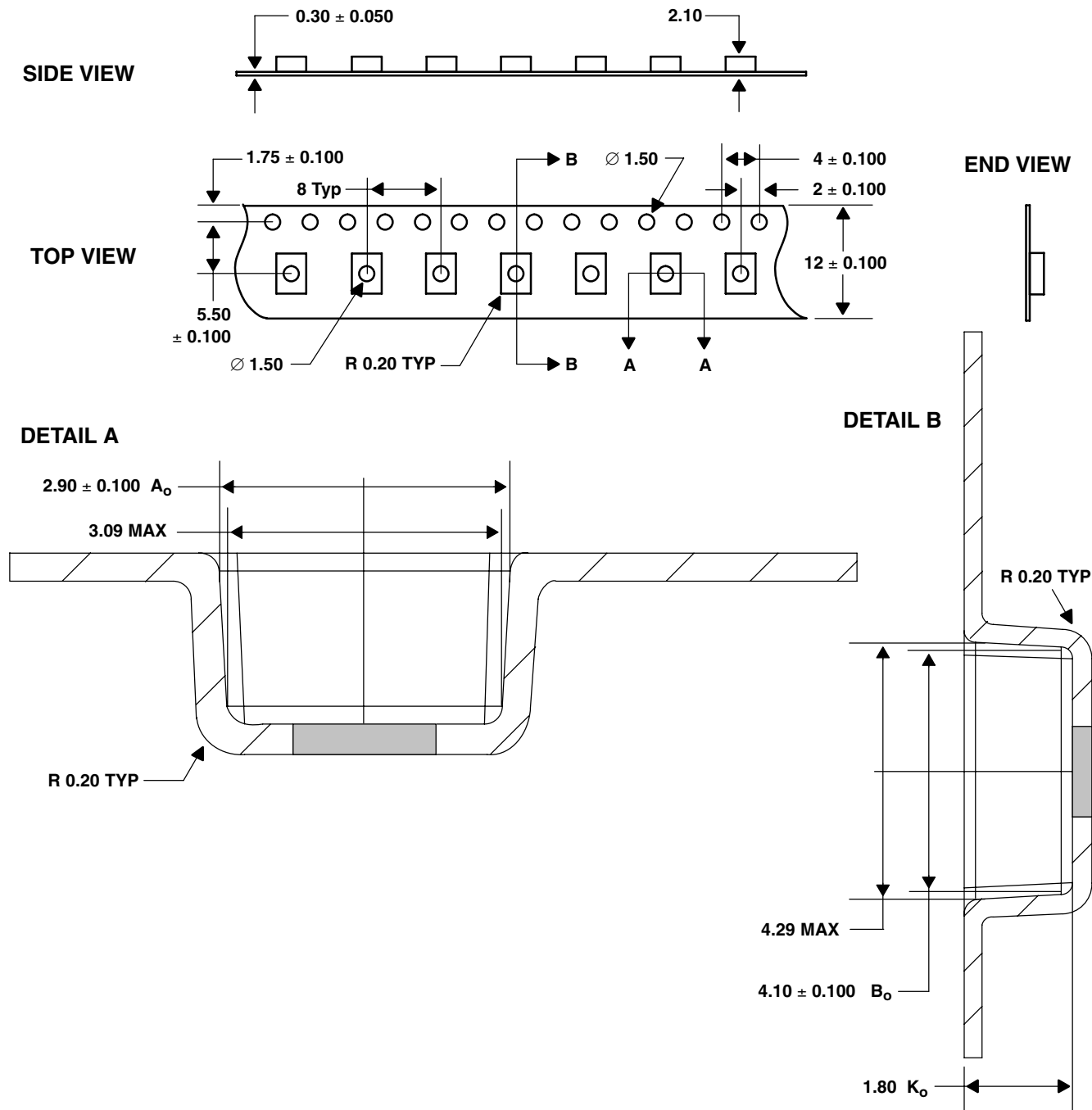

- NOTES: A. All linear dimensions are in millimeters.  
 B. The dimensions on this drawing are for illustrative purposes only. Dimensions of an actual carrier may vary slightly.  
 C. Symbols on drawing A<sub>0</sub>, B<sub>0</sub>, and K<sub>0</sub> are defined in ANSI EIA Standard 481-B 2001.  
 D. Each reel is 178 millimeters in diameter and contains 1000 parts.  
 E. TAOS packaging tape and reel conform to the requirements of EIA Standard 481-B.  
 F. In accordance with EIA standard, device pin 1 is located next to the sprocket holes in the tape.  
 G. This drawing is subject to change without notice.

Figure 22. TSL2568/TSL2569 TMB Carrier Tape

# TSL2568, TSL2569 LIGHT-TO-DIGITAL CONVERTER

TAOS091D – DECEMBER 2008

## MANUFACTURING INFORMATION

The CS and T packages have been tested and have demonstrated an ability to be reflow soldered to a PCB substrate. The process, equipment, and materials used in these test are detailed below.

The solder reflow profile describes the expected maximum heat exposure of components during the solder reflow process of product on a PCB. Temperature is measured on top of component. The components should be limited to a maximum of three passes through this solder reflow profile.

**Table 13. TSL2568/69 Solder Reflow Profile**

PARAMETER	REFERENCE	TSL2568/69
Average temperature gradient in preheating		2.5°C/sec
Soak time	$t_{soak}$	2 to 3 minutes
Time above 217°C	$t_1$	Max 60 sec
Time above 230°C	$t_2$	Max 50 sec
Time above $T_{peak} - 10^\circ\text{C}$	$t_3$	Max 10 sec
Peak temperature in reflow	$T_{peak}$	260° C (-0°C/+5°C)
Temperature gradient in cooling		Max -5°C/sec

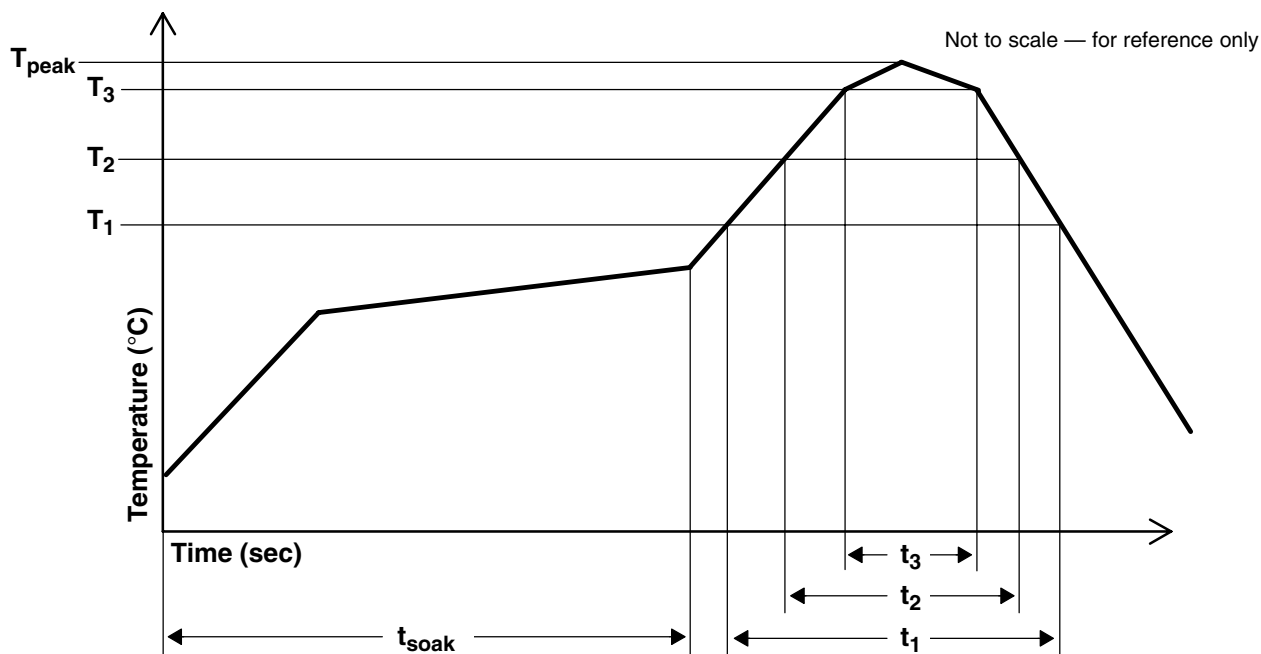

**Figure 23. TSL2568/TSL2569 Solder Reflow Profile Graph**



---

## MANUFACTURING INFORMATION

### Tooling Required

- Chipscale
  - Solder stencil (square aperture size 0.210 mm, stencil thickness of 152  $\mu\text{m}$ )
- TMB
  - Solder stencil (aperture size 0.70 mm x 0.90 mm, stencil thickness of 152  $\mu\text{m}$ )

### Process

1. Apply solder paste using stencil
2. Place component
3. Reflow solder/cure
4. X-Ray verify (recommended for chipscale only)

### Additional Notes for Chipscale

Placement of the TSL2568/TSL2569 chipscale device onto the gold immersion substrate is accomplished using a standard surface mount manufacturing process. Using a 152- $\mu\text{m}$  stencil with a 0.21 mm square aperture, print solder paste onto the substrate. Machine-place the TSL2568/TSL2569 from the tape onto the substrate. A suggest pick-up tool is the Siemens Vacuum Pickup tool nozzle number 912. This nozzle has a rubber tip with a diameter of approximately 0.75 mm. The part is picked up from the center of the body.

It is important to use a substrate that has an immersion plating surface. This may be immersion gold, solder, or white tin. Hot air solder leveled (HASL) substrates are not coplanar, making them difficult to work with.

# TSL2568, TSL2569 LIGHT-TO-DIGITAL CONVERTER

TAOS091D – DECEMBER 2008

---

## MANUFACTURING INFORMATION

### Moisture Sensitivity

Optical characteristics of the device can be adversely affected during the soldering process by the release and vaporization of moisture that has been previously absorbed into the package molding compound. To ensure the package molding compound contains the smallest amount of absorbed moisture possible, each device is dry-baked prior to being packed for shipping. Devices are packed in a sealed aluminized envelope with silica gel to protect them from ambient moisture during shipping, handling, and storage before use.

The CS package has been assigned a moisture sensitivity level of MSL 2 and the devices should be stored under the following conditions:

Temperature Range	5°C to 50°C
Relative Humidity	60% maximum
Floor Life	1 year out of bag at ambient < 30°C / 60% RH

Rebaking will be required if the aluminized envelope has been open for more than 1 year. If rebaking is required, it should be done at 90°C for 3 hours.

The T package has been assigned a moisture sensitivity level of MSL 3 and the devices should be stored under the following conditions:

Temperature Range	5°C to 50°C
Relative Humidity	60% maximum
Total Time	6 months from the date code on the aluminized envelope — if unopened
Opened Time	168 hours or fewer

Rebaking will be required if the devices have been stored unopened for more than 6 months or if the aluminized envelope has been open for more than 168 hours. If rebaking is required, it should be done at 90°C for 4 hours.

**PRODUCTION DATA** — information in this document is current at publication date. Products conform to specifications in accordance with the terms of Texas Advanced Optoelectronic Solutions, Inc. standard warranty. Production processing does not necessarily include testing of all parameters.

### ***LEAD-FREE (Pb-FREE) and GREEN STATEMENT***

**Pb-Free (RoHS)** TAOS' terms *Lead-Free* or *Pb-Free* mean semiconductor products that are compatible with the current RoHS requirements for all 6 substances, including the requirement that lead not exceed 0.1% by weight in homogeneous materials. Where designed to be soldered at high temperatures, TAOS Pb-Free products are suitable for use in specified lead-free processes.

**Green (RoHS & no Sb/Br)** TAOS defines *Green* to mean Pb-Free (RoHS compatible), and free of Bromine (Br) and Antimony (Sb) based flame retardants (Br or Sb do not exceed 0.1% by weight in homogeneous material).

**Important Information and Disclaimer** The information provided in this statement represents TAOS' knowledge and belief as of the date that it is provided. TAOS bases its knowledge and belief on information provided by third parties, and makes no representation or warranty as to the accuracy of such information. Efforts are underway to better integrate information from third parties. TAOS has taken and continues to take reasonable steps to provide representative and accurate information but may not have conducted destructive testing or chemical analysis on incoming materials and chemicals. TAOS and TAOS suppliers consider certain information to be proprietary, and thus CAS numbers and other limited information may not be available for release.

### **NOTICE**

Texas Advanced Optoelectronic Solutions, Inc. (TAOS) reserves the right to make changes to the products contained in this document to improve performance or for any other purpose, or to discontinue them without notice. Customers are advised to contact TAOS to obtain the latest product information before placing orders or designing TAOS products into systems.

TAOS assumes no responsibility for the use of any products or circuits described in this document or customer product design, conveys no license, either expressed or implied, under any patent or other right, and makes no representation that the circuits are free of patent infringement. TAOS further makes no claim as to the suitability of its products for any particular purpose, nor does TAOS assume any liability arising out of the use of any product or circuit, and specifically disclaims any and all liability, including without limitation consequential or incidental damages.

TEXAS ADVANCED OPTOELECTRONIC SOLUTIONS, INC. PRODUCTS ARE NOT DESIGNED OR INTENDED FOR USE IN CRITICAL APPLICATIONS IN WHICH THE FAILURE OR MALFUNCTION OF THE TAOS PRODUCT MAY RESULT IN PERSONAL INJURY OR DEATH. USE OF TAOS PRODUCTS IN LIFE SUPPORT SYSTEMS IS EXPRESSLY UNAUTHORIZED AND ANY SUCH USE BY A CUSTOMER IS COMPLETELY AT THE CUSTOMER'S RISK.

LUMENOLOGY, TAOS, the TAOS logo, and Texas Advanced Optoelectronic Solutions are registered trademarks of Texas Advanced Optoelectronic Solutions Incorporated.

# TSL2568, TSL2569 LIGHT-TO-DIGITAL CONVERTER

TAOS091D – DECEMBER 2008

---

## **X-ON Electronics**

Largest Supplier of Electrical and Electronic Components

*Click to view similar products for [Light to Digital Converters](#) category:*

*Click to view products by [ams](#) manufacturer:*

Other Similar products are found below :

[LTR-559ALS-01](#) [LTR-553ALS-01](#) [TSL27721FN](#) [TCS34727FN](#) [TCS37013M](#) [TCS37073M](#) [TSL25413](#) [TSL2584TSV](#) [TSL27713FN](#)  
[BH1745NUC-E2](#) [AS3400-EQFP-500](#) [TSL25723FN](#) [TSL25715FN](#) [LTR-507ALS-01](#)