

## Transient Voltage Suppressors

### Features

- ◆ 5000W peak pulse power capability at 10/1000 $\mu$ s waveform, Repetition rate (duty cycle):0.01%
- ◆ For surface mounted applications to optimize board space
- ◆ Low incremental surge impedance
- ◆ Excellent clamping capability
- ◆ Photo Glass and LPCVD process
- ◆ Fast response time: typically less than 1ps from 0V to BV min.
- ◆ Typical  $I_R$  less than 2 $\mu$ A above 12V.
- ◆ High Temperature soldering guaranteed: 260 $^{\circ}$ C/40 seconds at terminals
- ◆ Plastic package has underwriters laboratory flammability 94V-0
- ◆ Meets MSL level 1, per J-STD-020.
- ◆ Meet Halogen free and RoHS compliant
- ◆ AEC-Q101 qualified available
- ◆ Automotive product No.: base P/N-H

### Mechanical Data

- ◆ Case: JEDEC DO-214AB
- ◆ Polarity: Color band denotes positive end (cathode) except bi-directional models
- ◆ Weight: About 0.21g

### Partnumber Coding System

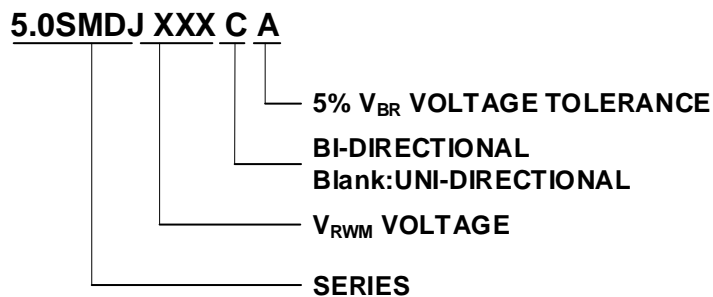

### Application

- ◆ Power Supply: DC12V/24V、The DC48V of POE RJ45 etc.
- ◆ Communication: RS485、 RS232 etc

Uni-directional

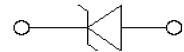
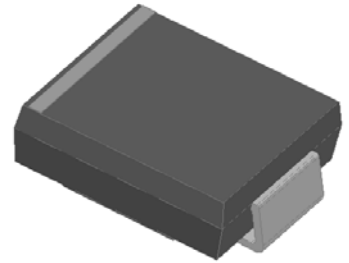

Bi-directional

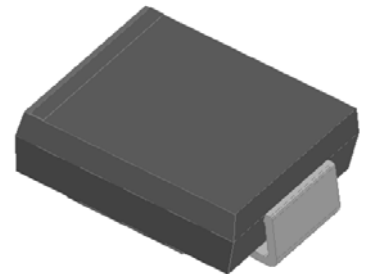

## 5.0SMDJ SERIES

### Maximum Ratings and Characteristics

Parameters at 25°C ambient temperature unless otherwise Noted.

Rating	Symbol	Value	Units
Peak pulse power dissipation at 10/1000μs waveform (Note1, Note2, Fig.1)	$P_{PPM}$	Minimum 5000	Watts
Peak pulse current of at 10/1000μs waveform (Note 1, Fig.3)	$I_{PPM}$	See Table	Amps
Steady state power dissipation at $T_A=50^{\circ}\text{C}$ (Fig.5)	$P_{M(AV)}$	6.5	Watts
Maximum Instantaneous Forward Voltage at 100A for Unidirectional	VF	4.0	V
<sup>Only</sup> Peak forward surge current, 8.3ms single half sine-wave superimposed on rated load, (JEDEC Method) (Note3, Fig.6)	$I_{FSM}$	300	Amps
Operating junction and Storage Temperature Range.	$T_J, T_{STG}$	-55 to +175	°C

Notes: 1. Non-repetitive current pulse, per Fig.3 and derated above  $T_A=25^{\circ}\text{C}$  per Fig.2.

2. Mounted on 8.0mm×8.0mm copper pads to each terminal.

3. 8.3ms single half sine-wave, or equivalent square wave, duty cycle=4 pulses per minutes maximum.

### Dimensions (DO-214AB/SMC)

Symbol	Millimeters		Inches	
	Min.	Max.	Min.	Max.
A	2.90	3.20	0.114	0.126
B	6.60	7.11	0.260	0.280
C	5.59	6.22	0.220	0.245
D	2.06	2.62	0.079	0.103
E	0.76	1.52	0.030	0.060
F	-	0.203	-	0.008
G	7.75	8.130	0.305	0.320
H	0.152	0.305	0.006	0.012
I	3.30	-	0.129	-
J	2.40	-	0.094	-
K	-	4.20	-	0.165

# 5.0SMDJ SERIES

## Electrical Characteristics

Part Number (Uni)	Part Number (Bi)	Marking		Reverse Stand off Voltage $V_R$ (Volts)	Breakdown Voltage $V_{BR}$ (Volts) @ $I_T$		Test Current $I_T$ (mA)	Maximum Clamping Voltage $V_C$ @ $I_{PP}$ (V)	Maximum Peak Pulse Current $I_{PP}$ (A)	Maximum Reverse Leakage $I_R$ @ $V_R$ ( $\mu$ A)
		UNI	BI		MIN	MAX				
5.0SMDJ12A	5.0SMDJ12CA	5PEP	5BEP	12.0	13.30	14.70	10	19.9	252.00	800
5.0SMDJ13A	5.0SMDJ13CA	5PEQ	5BEQ	13.0	14.40	15.90	10	21.5	233.00	500
5.0SMDJ14A	5.0SMDJ14CA	5PER	5BER	14.0	15.60	17.20	10	23.2	216.00	200
5.0SMDJ15A	5.0SMDJ15CA	5PES	5BES	15.0	16.70	18.50	1	24.4	205.00	100
5.0SMDJ16A	5.0SMDJ16CA	5PET	5BET	16.0	17.80	19.70	1	26.0	193.00	50
5.0SMDJ17A	5.0SMDJ17CA	5PEU	5BEU	17.0	18.90	20.90	1	27.6	181.00	20
5.0SMDJ18A	5.0SMDJ18CA	5PEV	5BEV	18.0	20.00	22.10	1	29.2	172.00	10
5.0SMDJ20A	5.0SMDJ20CA	5PEW	5BEW	20.0	22.20	24.50	1	32.4	155.00	5
5.0SMDJ22A	5.0SMDJ22CA	5PEX	5BEX	22.0	24.40	26.90	1	35.5	141.00	5
5.0SMDJ24A	5.0SMDJ24CA	5PEZ	5BEZ	24.0	26.70	29.50	1	38.9	129.00	5
5.0SMDJ26A	5.0SMDJ26CA	5PFE	5BFE	26.0	28.90	31.90	1	42.1	119.00	5
5.0SMDJ28A	5.0SMDJ28CA	5PFG	5BFG	28.0	31.10	34.40	1	45.4	110.00	5
5.0SMDJ30A	5.0SMDJ30CA	5PFK	5BFK	30.0	33.30	36.80	1	48.4	103.00	5
5.0SMDJ33A	5.0SMDJ33CA	5PFM	5BFM	33.0	36.70	40.60	1	53.3	93.90	5
5.0SMDJ36A	5.0SMDJ36CA	5PFP	5BFP	36.0	40.00	44.20	1	58.1	86.10	5
5.0SMDJ40A	5.0SMDJ40CA	5PFR	5BFR	40.0	44.40	49.10	1	64.5	77.60	5
5.0SMDJ43A	5.0SMDJ43CA	5PFT	5BFT	43.0	47.80	52.80	1	69.4	72.10	5
5.0SMDJ45A	5.0SMDJ45CA	5PFV	5BFV	45.0	50.00	55.30	1	72.7	68.80	5
5.0SMDJ48A	5.0SMDJ48CA	5PFX	5BFX	48.0	53.30	58.90	1	77.4	64.70	5
5.0SMDJ51A	5.0SMDJ51CA	5PFZ	5BFZ	51.0	56.70	62.70	1	82.4	60.70	5
5.0SMDJ54A	5.0SMDJ54CA	5RGE	5RGE	54.0	60.00	66.30	1	87.1	57.50	5
5.0SMDJ58A	5.0SMDJ58CA	5PGG	5BGG	58.0	64.40	71.20	1	93.6	53.50	5
5.0SMDJ60A	5.0SMDJ60CA	5PGK	5BGK	60.0	66.70	73.70	1	96.8	51.70	5
5.0SMDJ64A	5.0SMDJ64CA	5PGM	5BGM	64.0	71.10	78.60	1	103.0	48.60	5
5.0SMDJ70A	5.0SMDJ70CA	5PGP	5BGP	70.0	77.80	86.00	1	113.0	44.30	5
5.0SMDJ75A	5.0SMDJ75CA	5PGR	5BGR	75.0	83.30	92.10	1	121.0	41.40	5
5.0SMDJ78A	5.0SMDJ78CA	5PGT	5BGT	78.0	86.70	95.80	1	126.0	39.70	5
5.0SMDJ85A	5.0SMDJ85CA	5PGV	5BGV	85.0	94.40	104.00	1	137.0	36.50	5
5.0SMDJ90A	5.0SMDJ90CA	5PGX	5BGX	90.0	100.00	111.00	1	146.0	34.30	5
5.0SMDJ100A	5.0SMDJ100CA	5PGZ	5BGZ	100.0	111.00	123.00	1	162.0	30.90	5
5.0SMDJ110A	5.0SMDJ110CA	5PHE	5BHE	110.0	122.00	135.00	1	177.0	28.30	5
5.0SMDJ120A	5.0SMDJ120CA	5PHG	5BHG	120.0	133.00	147.00	1	193.0	26.00	5
5.0SMDJ130A	5.0SMDJ130CA	5PHK	5BHK	130.0	144.00	159.00	1	209.0	24.00	5
5.0SMDJ140A	5.0SMDJ140CA	5PHB	5BHB	140.0	155.00	171.00	1	226.8	22.20	5
5.0SMDJ150A	5.0SMDJ150CA	5PHM	5BHM	150.0	167.00	185.00	1	243.0	20.60	5
5.0SMDJ160A	5.0SMDJ160CA	5PHP	5BHP	160.0	178.00	197.00	1	259.0	19.30	5
5.0SMDJ170A	5.0SMDJ170CA	5PHR	5BHR	170.0	189.00	209.00	1	275.0	18.20	5
5.0SMDJ180A	5.0SMDJ180CA	5PKE	5BKE	180.0	200.20	220.00	1	291.6	17.10	5
5.0SMDJ190A	5.0SMDJ190CA	5PKG	5BKG	190.0	211.00	232.00	1	307.8	16.20	5
5.0SMDJ200A	5.0SMDJ200CA	5PKK	5BKK	200.0	224.00	247.00	1	324.0	15.40	5
5.0SMDJ220A	5.0SMDJ220CA	5PKM	5BKM	220.0	246.00	272.00	1	356.0	14.00	5
5.0SMDJ250A	5.0SMDJ250CA	5PKP	5BKP	250.0	279.00	309.00	1	405.0	12.30	5
5.0SMDJ300A	5.0SMDJ300CA	5PKR	5BKR	300.0	335.00	371.00	1	486.0	10.30	5
5.0SMDJ350A	5.0SMDJ350CA	5PKT	5BKT	350.0	391.00	432.00	1	567.0	8.80	5
5.0SMDJ400A	5.0SMDJ400CA	5PKV	5BKV	400.0	447.00	494.00	1	648.0	7.70	5
5.0SMDJ440A	5.0SMDJ440CA	5PKX	5BKX	440.0	492.00	543.00	1	713.0	7.00	5

Notes: For bidirectional type having  $V_{RWM}$  of 10V and less, the  $I_R$  limit is double.

# 5.0SMDJ SERIES

## Ratings and Characteristic Curves ( $T_A=25^\circ\text{C}$ unless otherwise noted)

Figure 1. Peak Pulse Power Rating Curve

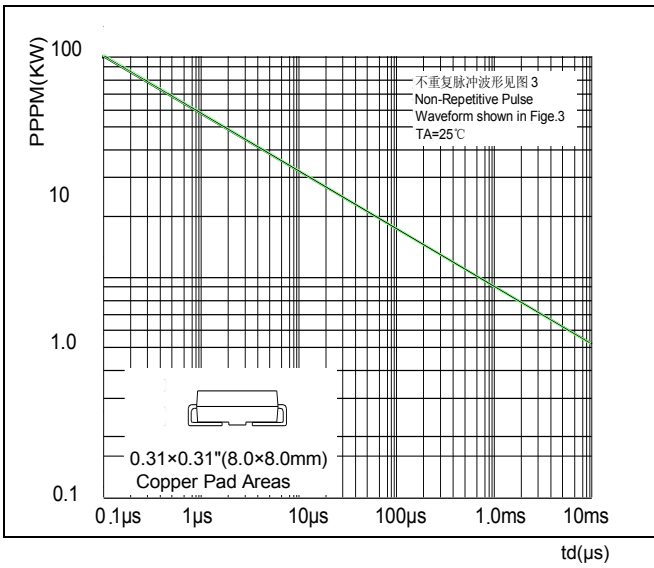

Figure 2. Pulse Derating Curve

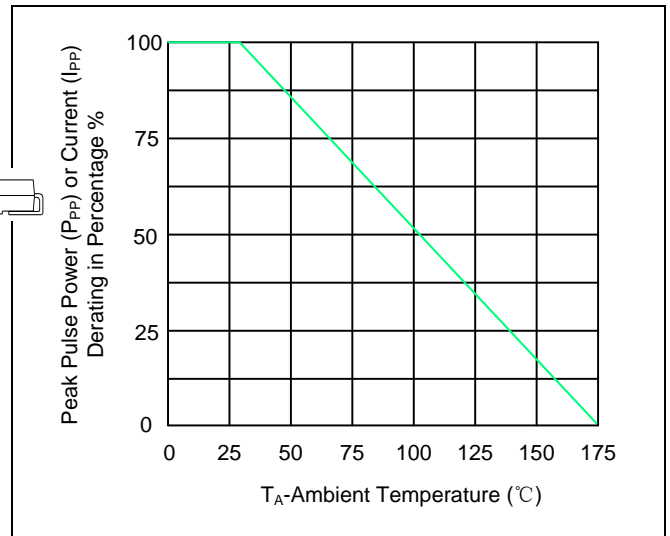

Figure 3. Pulse Waveform

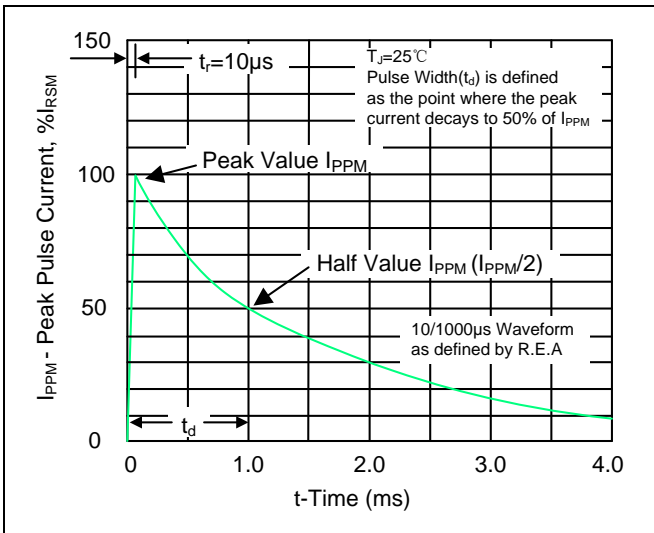

Figure 4. Typical Junction Capacitance

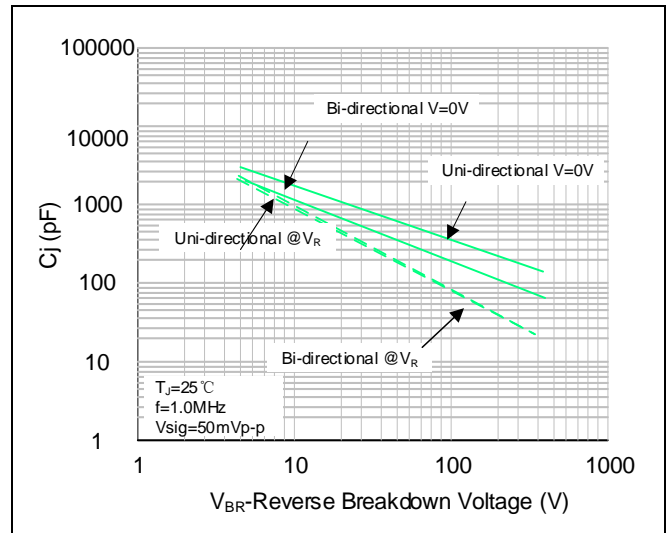

Figure 5. Steady State Power Dissipation Derating Curve

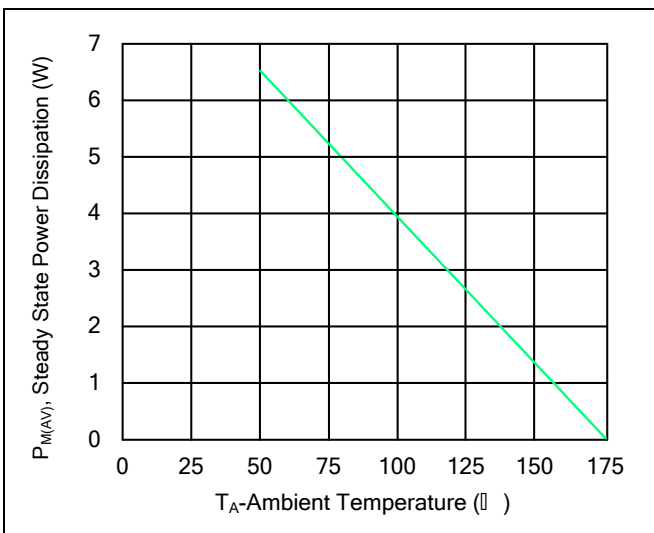
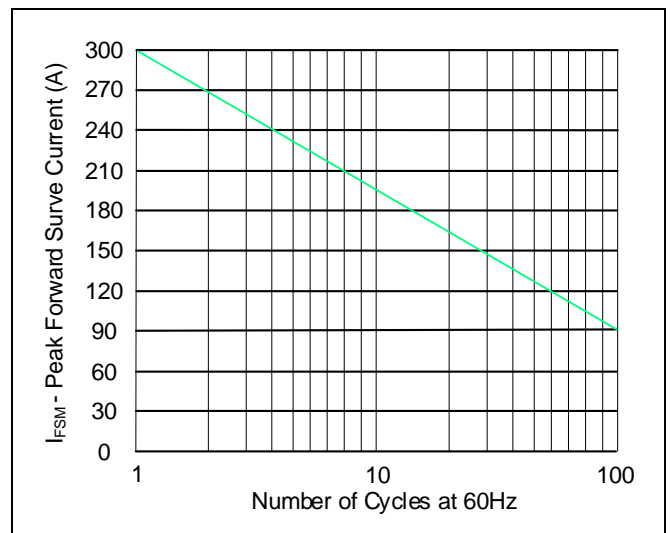
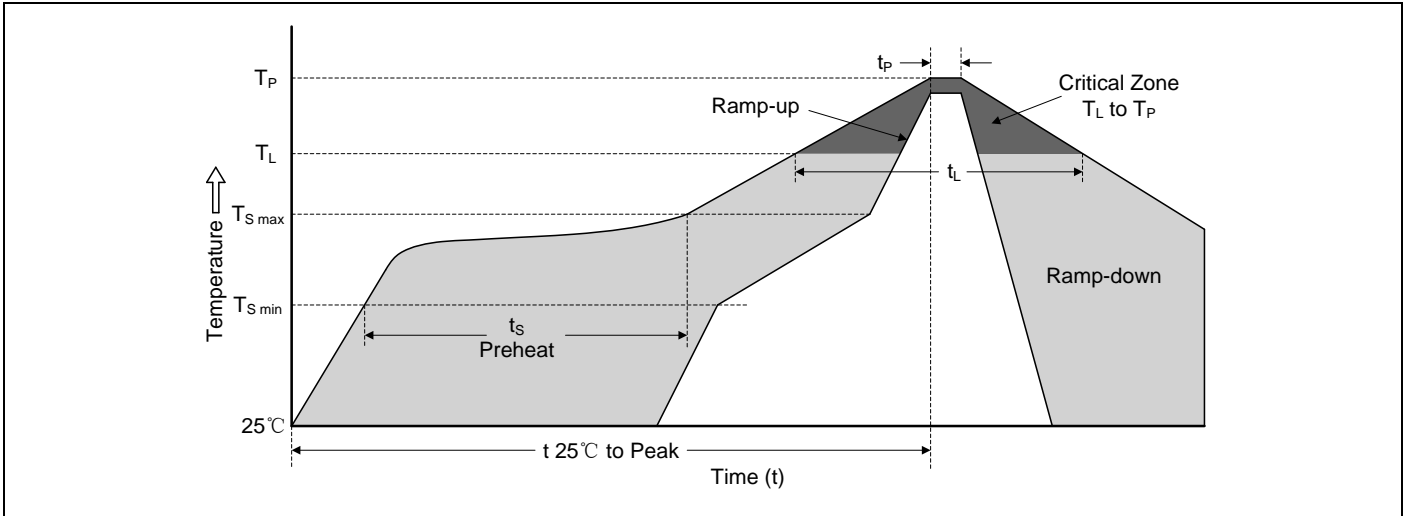

Figure 6. Maximum Non-Repetitive Forward Surge Current



ReflowSoldering Parameters



Reflow Condition		Lead-free Assembly
Pre heat	-Temperature Min ( $T_{S\ min}$ )	150°C
	-Temperature Max ( $T_{S\ max}$ )	200°C
	-Time (min to max) ( $t_s$ )	60-180 seconds
Average ramp-up rate ( $T_L$ to $T_P$ )		3°C/second max.
$T_{S\ max}$ to $T_L$ -Ramp-up Rate		3°C/second max.
Reflow	-Temperature ( $T_L$ ) (Liquidus)	217°C
	-Time (min to max) ( $t_s$ )	60-150 seconds
Peak Temperature ( $T_P$ )		260(+0/-5)°C
Time within 5°C of actual Peak Temperature ( $t_p$ )		20-40 seconds
Ramp-down Rate		6°C/second max.
Time 25°C to Peak Temperature		8 minutes max.
Do not exceed		280°C

Reliability

	Standards
Terminal strength	MIL-STD-750 Method 2036
Mechanical shock	JESD22-B104
Vibration	JESD22-B103
High Temp. Storage	JESD22-A103
High Temp Reverse Bias	JESD22-A108
Temperature Cycling	JESD22-A104
High Temp High humidityReverse Bias	JESD22-A101
Resistance to solder heat	JESD22-B106

# 5.0SMDJ SERIES



## Packaging

Part number	Component Package	Quantity	Packaging Option	Packaging Specification
5.0SMDJxxxXX	DO-214AB	3000	Tape & Reel-16mm tape/13" reel	EIA STD RS-481
5.0SMDJxxxXX-T7	DO-214AB	500	Tape & Reel-16mm tape/7" reel	EIA STD RS-481

## Tape and Reel Specification

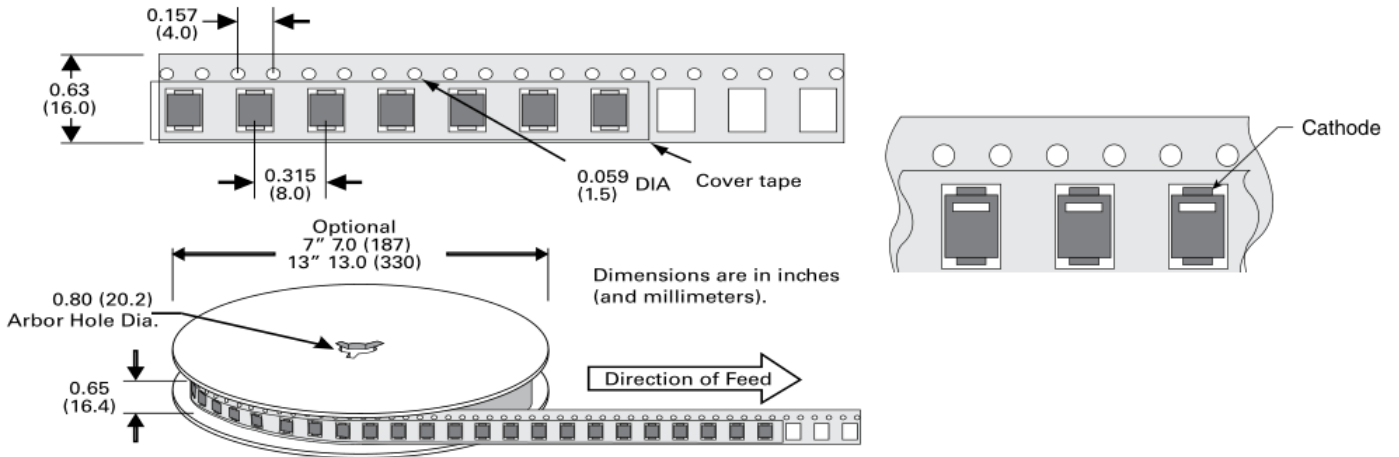

# IMPORTANT NOTICE AND DISCLAIMER

AM RESERVES THE RIGHT TO MAKE CHANGES TO ALL PRODUCT, PRODUCT SPECIFICATIONS AND DATA WITHOUT NOTICE TO IMPROVE RELIABILITY, FUNCTION OR DESIGN OR OTHERWISE. CUSTOMERS SHOULD OBTAIN AND CONFIRM THE LATEST PRODUCT INFORMATION AND SPECIFICATIONS BEFORE FINAL DESIGN PURCHASE OR USE.

AM disclaim any and all liability for any errors, inaccuracies or incompleteness contained in any datasheet or in any other disclosure relating to any product.

All information are provided as-is, even it has qualified by the AEC-Q101 which satisfy industrial application requirement, except as expressly stated in this data sheet is applied for automotive grade, AM make no warranties, representation or guarantee, whether express, implied or statutory, including, without limitation, regarding any merchantability, satisfactory quality, or fitness for a particular purpose with respect to AM.

AM does not assume any liability or compensation for any application assistance or customer product design, and make no warranty or accept any liability with products, which are purchased or used for any unintended or unauthorized application.

Except as expressly indicated in writing, AM products are not designed for use in medical, life-saving, or lifesustaining applications or for any other application in which the failure of the AM product could result in personal injury or death. Customers using or selling AM products not expressly indicated for use in such applications do so at their own risk. Please contact authorized AM personnel to obtain written terms and conditions regarding products designed for such applications.

No license, express or implied, by estoppel or otherwise, to any intellectual property rights is granted by this document or by any conduct of AM. Product names and markings noted herein may be trademarks of their respective owners.

## X-ON Electronics

Largest Supplier of Electrical and Electronic Components

*Click to view similar products for [ESD Suppressors / TVS Diodes](#) category:*

*Click to view products by [amsem](#) manufacturer:*

Other Similar products are found below :

[60KS200C](#) [D18V0L1B2LP-7B](#) [D5V0F4U5P5-7](#) [NTE4902](#) [P4KE27CA](#) [P6KE11CA](#) [P6KE8.2A](#) [JANTX1N6053A](#) [SA60CA](#) [SA64CA](#)  
[SMBJ12CATR](#) [SMBJ33CATR](#) [SMBJ6.5A](#) [SMBJ8.0A](#) [ESD101-B1-02ELS E6327](#) [ESD112-B1-02EL E6327](#) [ESD7451N2T5G](#) [19180-510](#)  
[CPDT-5V0USP-HF](#) [3.0SMCJ33CA-F](#) [3.0SMCJ36A-F](#) [HSPC16701B02TP](#) [JANTX1N6126A](#) [D3V3Q1B2DLP3-7](#) [D55V0M1B2WS-7](#)  
[SCM1293A-04SO](#) [ESD200-B1-CSP0201 E6327](#) [SM12-7](#) [CEN955 W/DATA](#) [VESD12A1A-HD1-GS08](#) [CPDQC5V0-HF](#) [D1213A-01LP4-7B](#)  
[ESD101-B1-02EL E6327](#) [AOZ8808DI-03](#) [5KP15A](#) [5KP48A](#) [5KP90A](#) [ESD3V3D7-TP](#) [15KPA36A-LF](#) [P4KE56CA](#) [P4KE68A](#)  
[P4KE91CATR](#) [P6KE120A](#) [P6KE13CA](#) [P6KE43CA](#) [P6KE6.8CA](#) [P6KE8.2](#) [P6SMBJ20CA](#) [JANTX1N6072A](#) [SR2835ESKG](#)