

DATA SHEET(Preliminary)

BAV316

- ◇ General purpose diodes
- ◇ High Switching Speed
- ◇ SOD323 Thin SMD package
- ◇ RoHS compliant / Green EMC
- ◇ Moisture Sensitivity Level 1

Device Marking Code	
BAV316	XX

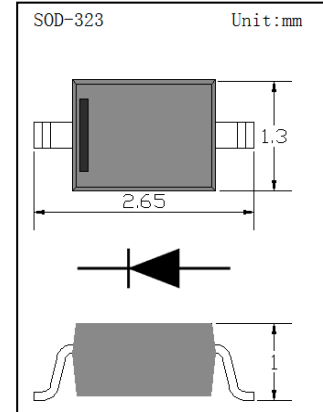

Absolute Maximum Ratings (Ta = 25 °C)

Symbol	Parameter	Value	Units
V _{RRM}	Repetitive Peak Reverse Voltage	130	V
V _R	Maximum DC Blocking Voltage	130	V
I _{F(AV)}	Average Forward Current	215	mA
I _{FSM}	Peak Forward Surge Current(t=8.3ms)	2	A
P _D	Power Dissipation	250	mW
T _J	Junction Temperature	-55 to +150	°C
R _{JA}	Thermal Resistance Junction to Ambient Air	500	°C/W
T _{STG}	Storage Temperature	-55 to +150	°C

Electrical Characteristics (Ta = 25 °C)

Symbol	Parameter	Conditions	Min	Typ	Max	Units
V _{BR}	Reverse Breakdown Voltage	I _R =100μA	130			V
V _F	Forward Voltage	I _F = 1mA I _F = 10mA I _F = 50mA I _F = 150mA			0.85 0.95 1 1.1	V V V V
I _R	Reverse current	V _R = 75V			5	nA
C _J	Junction Capacitance	V _R = 0V, f = 1MHz		2		pF
trr	Reverse Recovery Time	I _F = I _R = 10mA, I _{rr} = 0.1*I _R , R _L = 100 Ω			3	us

Typical Characteristics

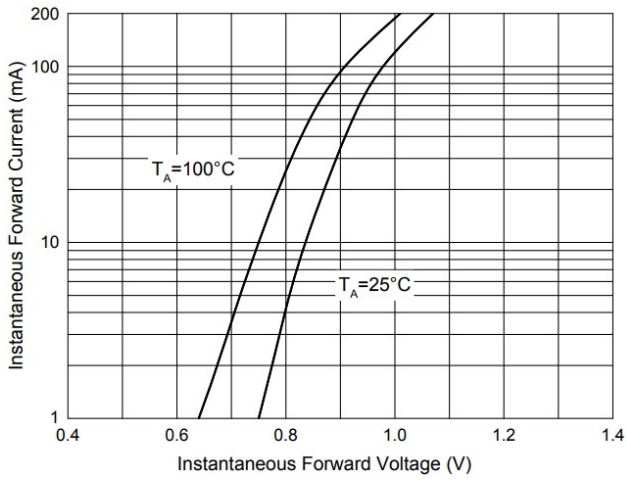

Typical Instantaneous Forward Characteristics

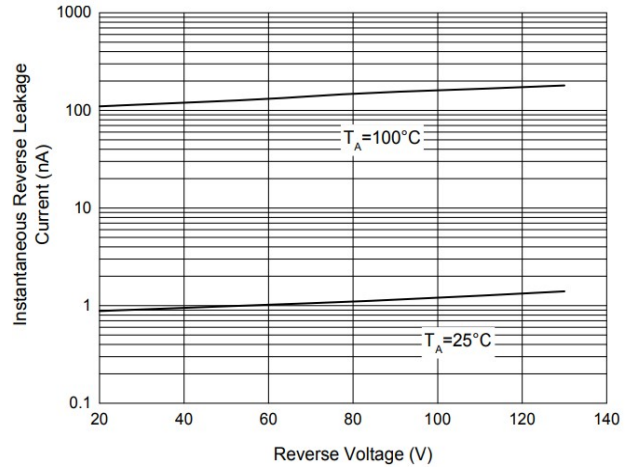

Typical Reverse Leakage Characteristics

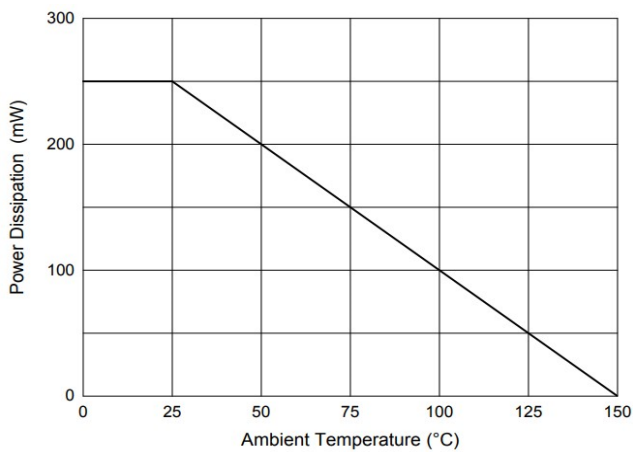

Power Derating Curve

Ordering Information

Device	Package	Shipping	Tape wide	Emboss pitch	Tape specification	Notes
BAV316	SOD323-GW	Tape & Reel 3000pcs /7" Reel	8 mm	4 mm	Conductive	

Package Dimensions

Package outline : SOD-323

Top View

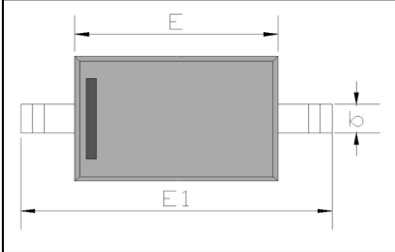

Side View

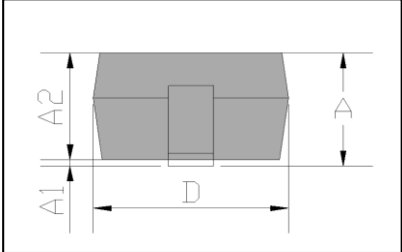

Symbol	Dimensions in mm	
	Min.	Max.
A		1.000
A1	0.000	0.100
A2	0.800	0.900
b	0.250	0.350
c	0.080	0.150
D	1.200	1.400
E	1.600	1.800
E1	2.500	2.700
L	0.475 REF.	
L1	0.250	0.400
θ	0°	8°

Front View

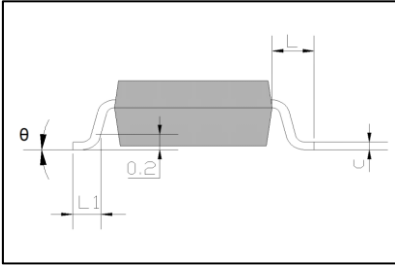

Soldering Pattern

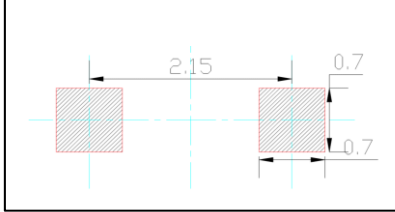

Notice:

2. Lead plating: Pb free solder
3. Lead thickness includes solder plating
4. Other Tolerance: ±0.05
5. Unit: mm

X-ON Electronics

Largest Supplier of Electrical and Electronic Components

Click to view similar products for [Diodes - General Purpose, Power, Switching category:](#)

Click to view products by [amsem manufacturer:](#)

Other Similar products are found below :

[MMBD3004S-13-F](#) [1N3611](#) [NTE156A](#) [NTE6244](#) [1SS400CST2RA](#) [SDAA13](#) [SHN2D02FUTW1T1G](#) [1N4449](#) [1N456A](#) [1N914BTR](#)
[D291S45T](#) [BAS 16-02L E6327](#) [BAS 16-02V H6327](#) [BAS 21U E6327](#) [BAS 28 E6327](#) [BAW56DWQ-7-F](#) [BAW56M3T5G](#) [BAW75-TAP](#)
[MM230L-CAA](#) [IDW40E65D1](#) [JAN1N3600](#) [JAN1N4454UR-1](#) [SMMSD4148T3G](#) [BYW95B/A52A](#) [NSVDAN222T1G](#) [CDSZC01100-HF](#)
[BAV70HDW-7](#) [BAS28-7](#) [JANTX1N6640](#) [BAW56HDW-13](#) [BAS28 TR](#) [VS-HFA04SD60STR-M3](#) [1SS388-TP](#) [BAV99TQ-13-F](#)
[BAV99HDW-13](#) [1N4004](#) [MMDB30-E28X](#) [LS4148](#) [IDV15E65D2](#) [W0503RH200S0L](#) [M0268SJ200NLF](#) [M0268RJ200NLF](#) [S3MBF](#) [US1J](#)
[DAN217U-TP](#) [SHV-06JNS-Q](#) [IDW30C65D1](#) [IDW80C65D1](#) [VS-HFA30TA60CSR-M3](#) [M1MA152WAT1](#)