

## DATA SHEET

### BZX884C2V4 THRU BZX884C75

- ◇ Planar Die construction
- ◇ 250mW Power Dissipation
- ◇ Zener Voltages from 2.4V–75V
- ◇ RoHS compliant / Green EMC

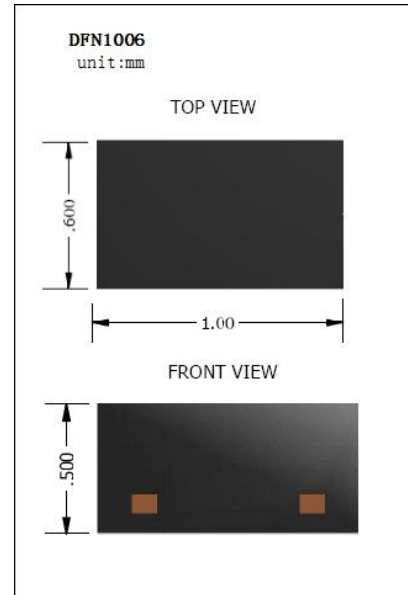
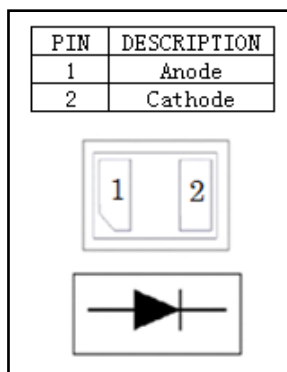

#### MAXIMUM RATINGS (Ta = 25 °C)

Symbol	Parameter	Value	Units
V <sub>F</sub>	Maximum Forward Voltage @ IF=10mA	0.9	V
P <sub>(AV)</sub>	Power Dissipation	250	mW
T <sub>J</sub> , T <sub>stg</sub>	Operating And Storage Temperature	-55 to 150	°C
I <sub>FSM</sub>	Peak Forward Surge Current	2.0	A
T <sub>stg</sub>	Storage Temperature Range	-55 to 150	°C
R <sub>j</sub>	Thermal Resistance Junction to Ambient	417	°C/W

#### ELECTRICAL CHARACTERISTICS (Ta = 25 °C unless otherwise noted)

Type	Device	V <sub>Z</sub> (V) *1			I <sub>ZT</sub>	Z <sub>ZT</sub> @I <sub>ZT</sub>	Z <sub>ZK</sub> @I <sub>ZK</sub>	I <sub>ZK</sub>	I <sub>R</sub>	V <sub>R</sub>
		Nom(V)	Min(V)	Max(V)						
BZX884C2V4	B1	2.4	2.28	2.52	5	100	400	1	50	1
BZX884C2V7	B2	2.7	2.57	2.84	5	100	450	1	20	1
BZX884C3V0	B3	3	2.85	3.15	5	95	500	1	10	1
BZX884C3V3	B4	3.3	3.14	3.47	5	95	500	1	5	1
BZX884C3V6	B5	3.6	3.42	3.78	5	90	500	1	5	1
BZX884C3V9	B6	3.9	3.71	4.1	5	90	500	1	3	1
BZX884C4V3	B7	4.3	4.09	4.52	5	90	600	1	3	1

Type	Device	V <sub>Z</sub> (V) * <sup>1</sup>			I <sub>ZT</sub>	Z <sub>ZT</sub> @I <sub>ZT</sub>	Z <sub>ZK</sub> @I <sub>ZK</sub>	I <sub>zk</sub>	I <sub>R</sub>	V <sub>R</sub>
Number	Marking	Nom(V)	Min(V)	Max(V)	mA	Ω		(mA)	(uA)	(V)
BZX884C4V7	B8	4.7	4.47	4.94	5	80	500	1	3	2
BZX884C5V1	B9	5.1	4.85	5.36	5	60	480	1	2	2
BZX884C5V6	BA	5.6	5.32	5.88	5	40	400	1	1	2
BZX884C6V2	BB	6.2	5.89	6.51	5	10	150	1	3	4
BZX884C6V8	BC	6.8	6.46	7.14	5	15	80	1	2	4
BZX884C7V5	BD	7.5	7.13	7.88	5	15	80	1	1	5
BZX884C8V2	BE	8.2	7.79	8.61	5	15	80	1	0.7	5
BZX884C9V1	BF	9.1	8.65	9.56	5	15	100	1	0.5	6
BZX884C10	BG	10	9.5	10.5	5	20	150	1	0.2	7
BZX884C11	BH	11	10.45	11.55	5	20	150	1	0.1	8
BZX884C12	BJ	12	11.4	12.6	5	25	150	1	0.1	8
BZX884C13	BK	13	12.35	13.65	5	30	170	1	0.1	8
BZX884C15	BL	15	14.25	15.75	5	30	200	1	0.05	10.5
BZX884C16	D1	16	15.2	16.8	5	40	200	1	0.05	11.2
BZX884C18	D2	18	17.1	18.9	5	45	225	1	0.05	12.6
BZX884C20	D3	20	19	21	5	55	225	1	0.05	14
BZX884C22	D4	22	20.9	23.1	5	55	250	1	0.05	15.4
BZX884C24	D5	24	22.8	25.2	5	70	250	1	0.05	16.8
BZX884C27	D6	27	25.65	28.35	2	80	300	0.5	0.05	18.9
BZX884C30	D7	30	28.5	31.5	2	80	300	0.5	0.05	21
BZX884C33	D8	33	31.35	34.65	2	80	325	0.5	0.05	23.1
BZX884C36	D9	36	34.2	37.8	2	90	350	0.5	0.05	25.2
BZX884C39	DA	39	37.05	40.95	2	130	350	0.5	0.05	27.3
BZX884C43	DB	43	40.85	45.15	2	150	375	0.5	0.05	30.1
BZX884C47	DD	47	44.65	49.35	2	170	375	0.5	0.05	32.9
BZX884C51	DD	51	48.45	53.55	2	180	400	0.5	0.05	35.7
BZX884C56	DE	56	53.2	58.8	2	200	425	0.5	0.05	39.2
BZX884C62	DF	62	58.9	65.1	2	215	450	0.5	0.05	43.4
BZX884C68	DG	68	64.6	71.4	2	240	475	0.5	0.05	47.6
BZX884C75	DH	75	71.25	78.75	2	255	500	0.5	0.05	52.5

\*<sup>1</sup> Pulse width = 10 ms

Typical Characteristics

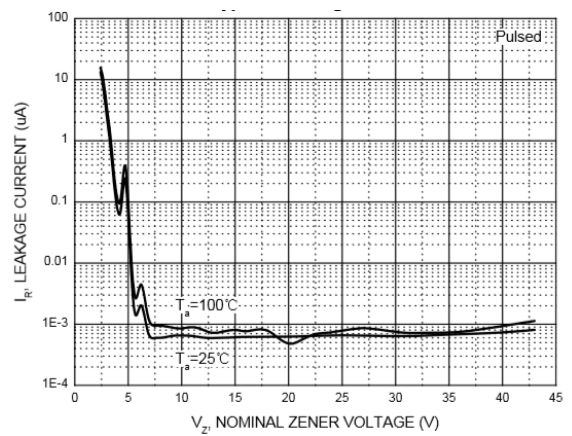
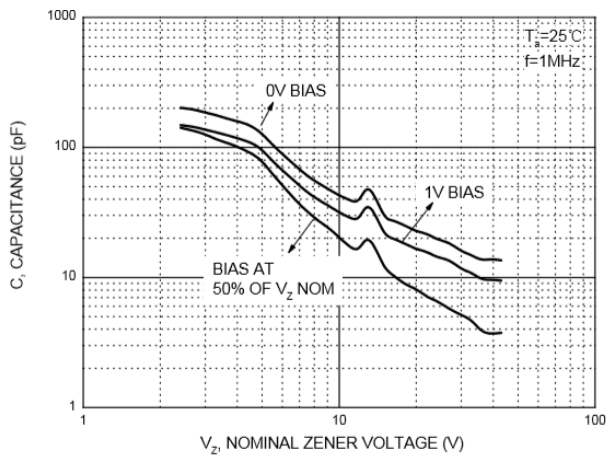
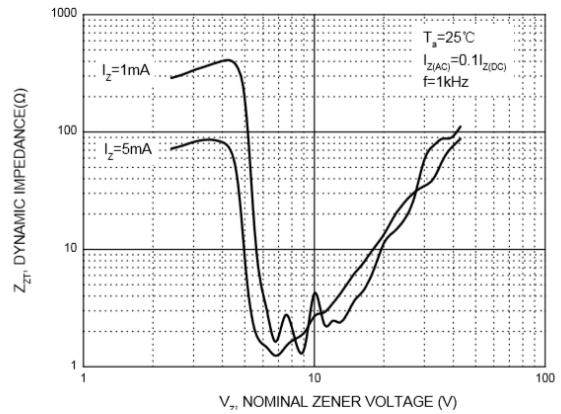
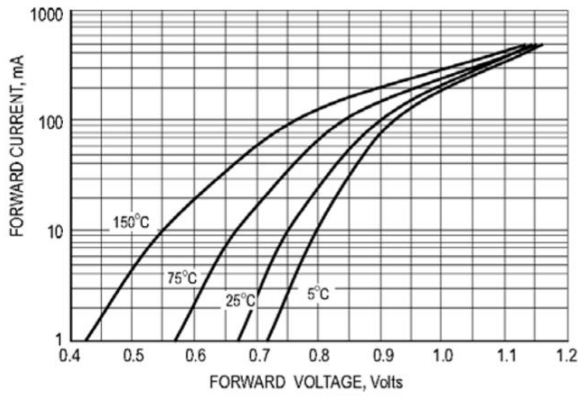
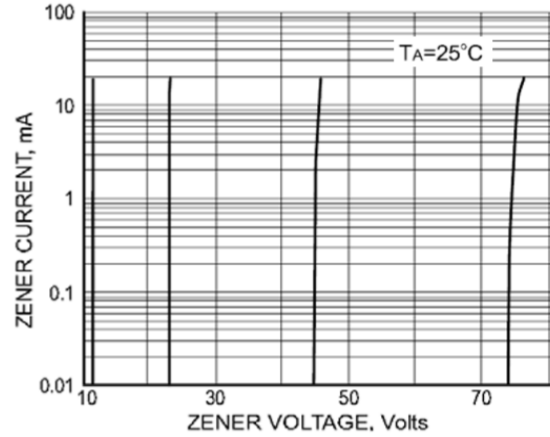
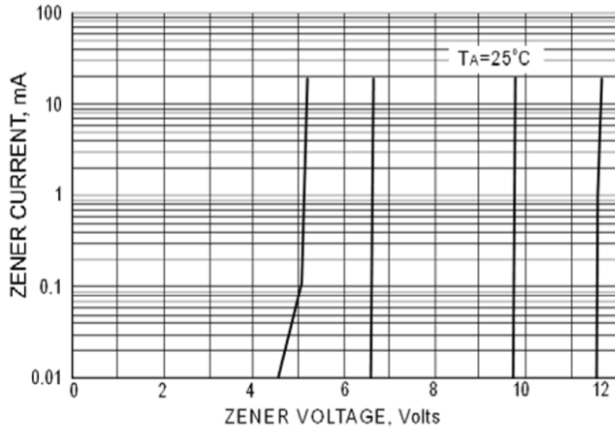

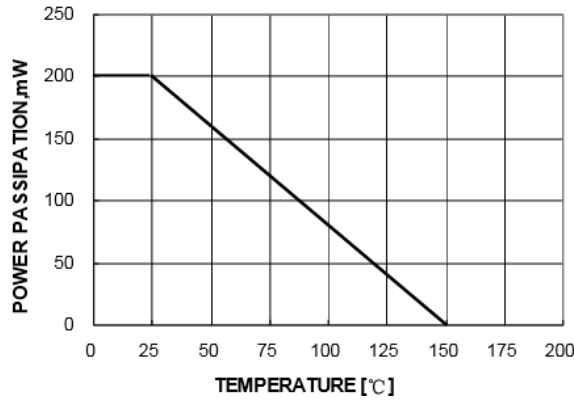

### ORDERING INFORMATION

Device	Package	Shipping	Tape wide	Emboss pitch	Tape specification	Notes
BZX884C2V4- BZX884C75	DFN1006	Tape & Reel 10000pcs /7" Reel	8mm	4mm	Conductive	

### PACKAGE DIMENSIONS

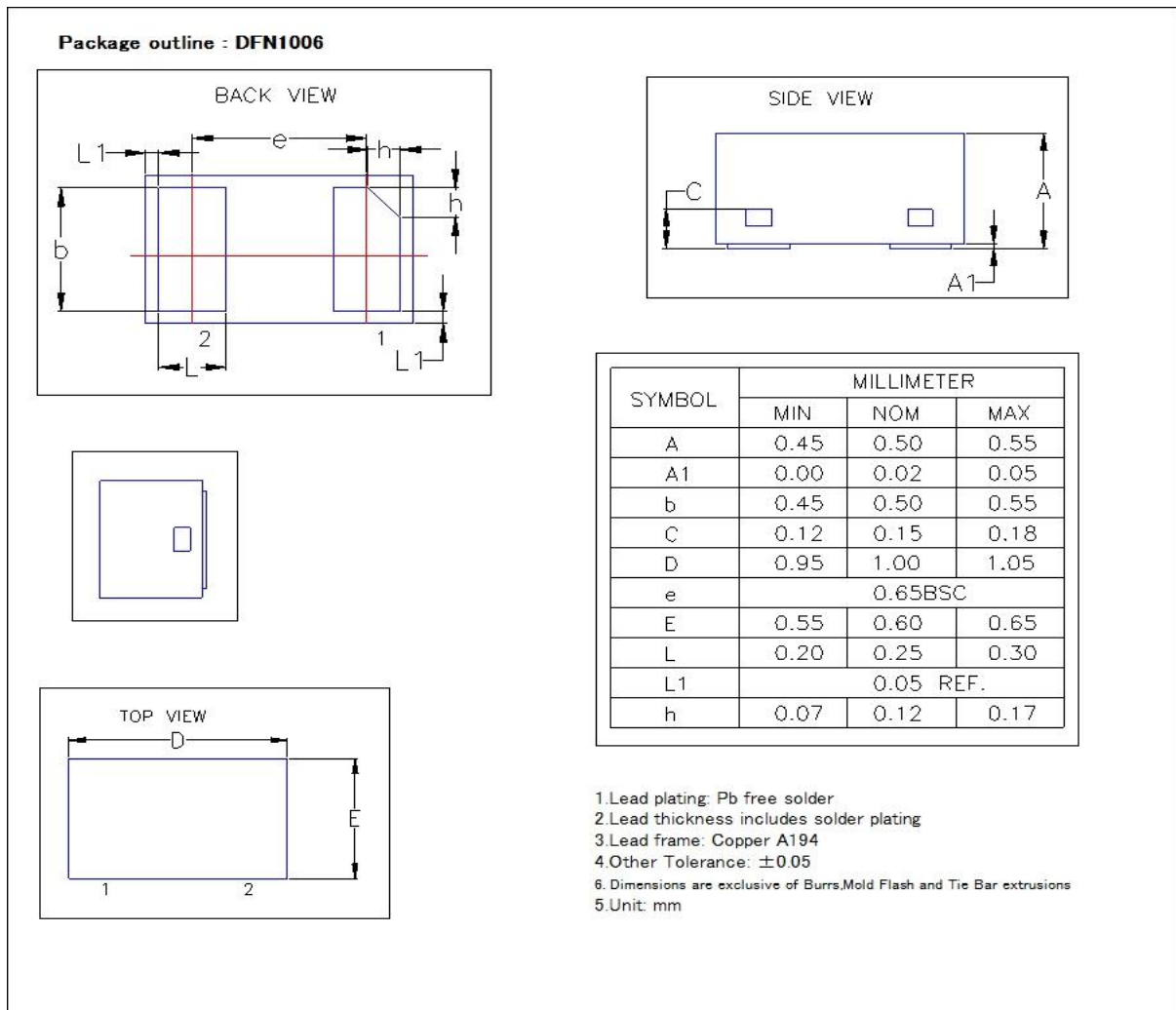

## X-ON Electronics

Largest Supplier of Electrical and Electronic Components

*Click to view similar products for [Zener Diodes](#) category:*

*Click to view products by [amsem](#) manufacturer:*

Other Similar products are found below :

[RKZ13B2KG#P1](#) [DL5234B](#) [1N4682](#) [1N4693](#) [1N4732A](#) [1N4736A](#) [1N4750A](#) [1N4759ARL](#) [1N5241B](#) [1N5365B](#) [1N5369B](#) [1N747A](#)  
[1N964B](#) [1N966B](#) [1N968B](#) [1N972B](#) [JANS1N4974US](#) [1N4692](#) [1N4702](#) [1N4704](#) [1N4711](#) [1N4714](#) [1N4745ARL](#) [1N4752ARL](#) [1N4760ARL](#)  
[1N5221B](#) [1N5242BTR](#) [1N5350B](#) [1N5352B](#) [1N961BRR1](#) [1N964BRL](#) [RKZ5.1BKU#P6](#) [3SMAJ5946B-TP](#) [3SMAJ5950B-TP](#)  
[MMSZ5230BQ-13-F](#) [MMSZ5232BQ-13-F](#) [BZX84C7V5](#) [3SMAJ5945B-TP](#) [3SMAJ5947B-TP](#) [3SMBJ5941B-TP](#) [DZ2S240M0L](#) [SMAZ27-](#)  
[TP](#) [ZMM5224B-7](#) [RD16UM-T1-A](#) [RD39S-T1-A](#) [RD10S-T1-A](#) [CDZT2R5.6B](#) [1N4762A G](#) [Z1SMA18](#) [JANTX1N4553B](#)