

Zener Diodes / DATA SHEET

M3Z2V4B – M3Z75VB series

- ◇ Constant Voltage control
- ◇ Wide Voltage Range Selection 2.4V to 75V
- ◇ Vz tolerance selection of $\pm 2\%$ (B series)
- ◇ SOD323F Thin SMD package
- ◇ RoHS compliant / Green EMC
- ◇ Matte Tin (Sn) Lead finish
- ◇ Cathode Band
- ◇ Device marking: Refer to table list

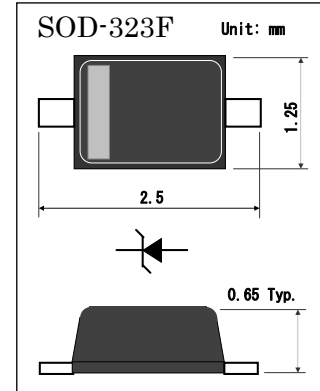

Absolute Maximum Ratings (Ta = 25 °C)

Symbol	Parameter	Value	Units
P_D	Power Dissipation	200	mW
T_J	Junction Temperature	150	°C
T_{STG}	Storage Temperature	-55 to +125	°C
I_{ZM}	Maximum Regulator Current	P_D/V_Z	mA

Electrical Characteristics (Ta = 25 °C)

Type Number	Device Marking	Vz(V)*1			Zzt(Ω)	Iz (mA)	Zzk(Ω)	Izk (mA)	IR(μA)	VR(V)
		min.	typ.	max.	max.		max.		max.	
M3Z2V4B	2.4	2.45	2.53	2.61	100	5	1000	0.5	120	1.0
M3Z2V7B	2.7	2.71	2.80	2.89	110	5	1000	0.5	100	1.0
M3Z3V0B	3.0	3.03	3.12	3.20	120	5	1000	0.5	50	1.0
M3Z3V3B	3.3	3.34	3.43	3.51	120	5	1000	0.5	20	1.0
M3Z3V6B	3.6	3.53	3.60	3.67	100	5	1000	1	10	1.0
M3Z3V9B	3.9	3.82	3.90	3.98	100	5	1000	1	5	1.0
M3Z4V3B	4.3	4.21	4.30	4.39	100	5	1000	1	5	1.0
M3Z4V7B	4.7	4.61	4.70	4.79	100	5	800	1	2	1.0
M3Z5V1B	5.1	5.00	5.10	5.20	80	5	500	1	2	1.0
M3Z5V6B	5.6	5.49	5.60	5.71	60	5	400	1	1	1.0
M3Z6V2B	6.2	6.08	6.20	6.32	60	5	150	1	1	2.0
M3Z6V8B	6.8	6.66	6.80	6.94	40	5	80	1	0.5	3.0
M3Z7V5B	7.5	7.35	7.50	7.65	30	5	60	1	0.5	5.0

Continued next page

Type Number	Device Marking	Vz(V)*1			Zzt(Ω)	Iz(mA)	Zzk(Ω)	Izk(mA)	IR(μ A)	VR(V)
		min.	typ.	max.	max.		max.		max.	
M3Z8V2B	8.2	8.04	8.20	8.36	30	5	60	1	0.5	6.1
M3Z9V1B	9.1	8.92	9.10	9.28	30	5	60	1	0.5	6.8
M3Z10VB	10.	9.80	10.00	10.20	30	5	70	1	0.1	7.5
M3Z11VB	11.	10.78	11.00	11.22	30	5	70	1	0.1	8.2
M3Z12VB	12.	11.76	12.00	12.24	30	5	90	1	0.1	9.0
M3Z13VB	13.	12.74	13.00	13.26	40	5	110	1	0.1	9.7
M3Z15VB	15.	14.70	15.00	15.30	45	5	110	1	0.1	11
M3Z16VB	16.	15.68	16.00	16.32	50	5	170	1	0.1	12
M3Z18VB	18.	17.64	18.00	18.36	65	5	170	1	0.1	14
M3Z20VB	20.	19.60	20.00	20.40	85	5	220	1	0.1	15
M3Z22VB	22.	21.56	22.00	22.44	100	5	220	1	0.1	17
M3Z24VB	24.	23.52	24.00	24.48	120	5	220	1	0.1	18
M3Z27VB	27.	26.46	27.00	27.54	150	5	220	1	0.1	20
M3Z30VB	30.	29.40	30.00	30.60	200	5	220	1	0.1	22
M3Z33VB	33.	32.34	33.00	33.66	250	5	250	1	0.1	24
M3Z36VB	36.	35.28	36.00	36.72	300	5	300	1	0.1	27
M3Z39VB	39.	38.22	39	39.78	130	5	350	0.5	0.1	27.3
M3Z43VB	43.	41.16	43	42.84	130	5	350	0.5	0.1	29.4
M3Z47VB	47.	45.83	47	48.17	170	5	1000	0.25	0.1	36
M3Z51VB	51.	49.73	51	52.27	180	5	1300	0.25	0.1	39
M3Z56VB	56.	54.60	56	57.40	200	5	1400	0.25	0.1	43
M3Z62VB	62.	60.45	62	63.55	225	5	1400	0.25	0.1	47
M3Z68VB	68.	66.30	68	69.70	240	5	1600	0.25	0.1	52
M3Z75VB	75.	73.13	75	76.87	265	5	1700	0.25	0.1	56

*1 Pulse width = 10 ms

Typical Characteristics

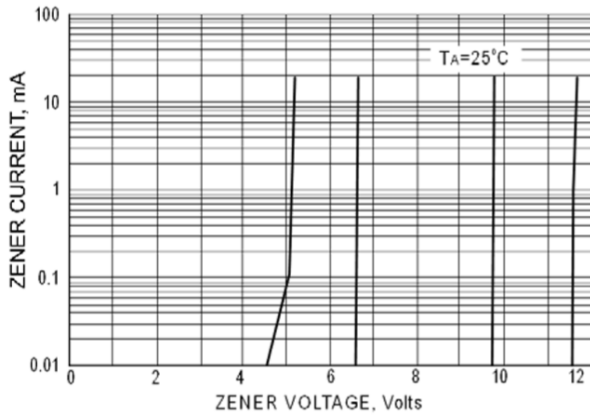

ZENER BREAKDOWN CHARACTERISTIC

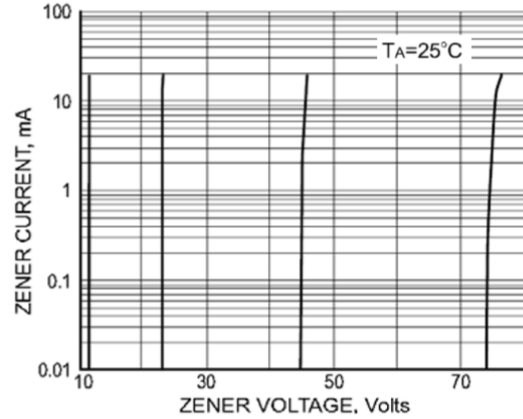

ZENER BREAKDOWN CHARACTERISTICS

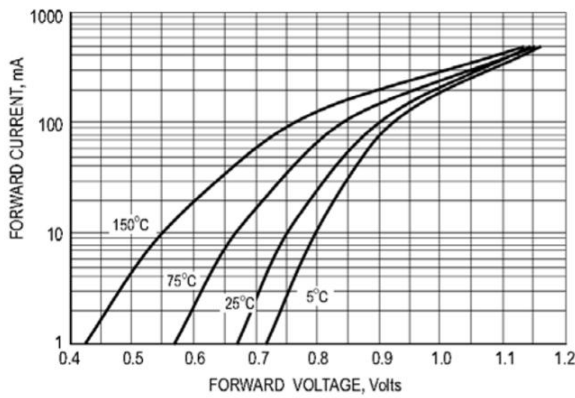

TYPICAL FORWARD VOLTAGE

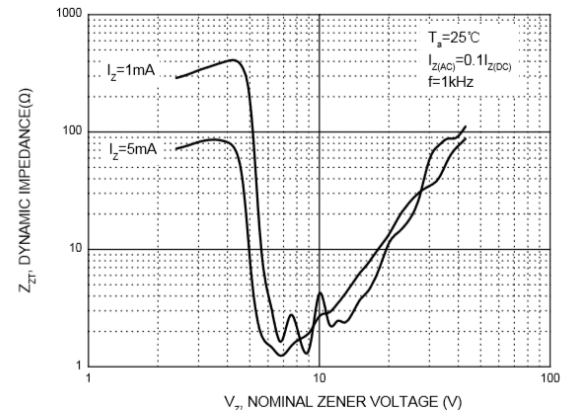

Effect of Zener Voltage on Zener Impedance

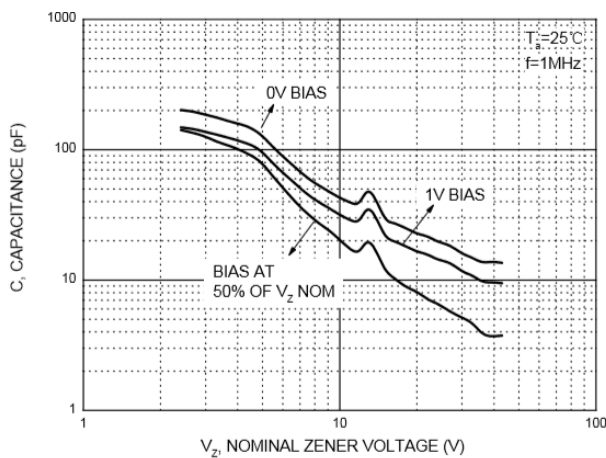

Typical Capacitance

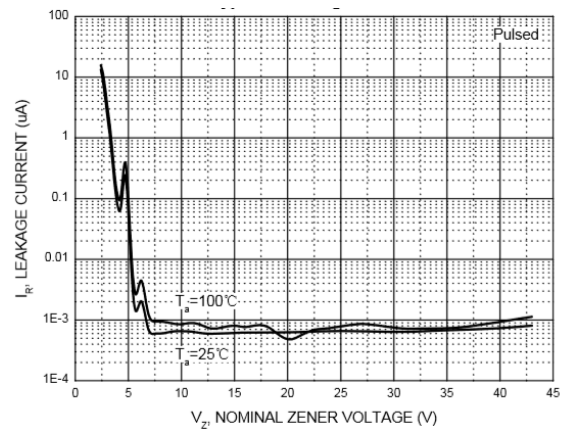

Typical Leakage Current

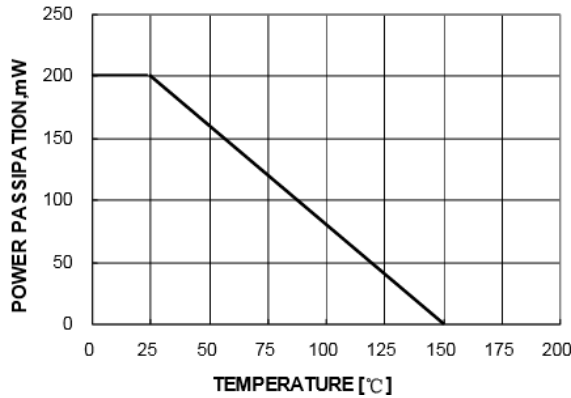

POWER DISSIPATION VS AMBIENT TEMP

Ordering Information

Device	Package	Shipping	Tape wide	Emboss pitch	Tape specification	Notes
M3ZxxxB series	SOD323F	Tape & Reel 3000pcs /7" Reel	8 mm	4 mm	Conductive	

Package Dimensions

SOD323F * Package Outline

Dimensions

Unit	A	B	C	D	E	F	G
Max.	1.80	0.21	0.50	0.40	2.70	0.75	1.35
Min.	1.60	0.06	0.30	0.25	2.30	0.60	1.15

Note:

1. Halogen free, EMC
2. Pb free solder
3. Lead thickness includes solder plating
4. Lead frame: Cu
5. Other Tolerance: ± 0.05
6. Dimensions are exclusive of Burrs, Mold Flash and Tie Bar extrusions
7. Unit: mm

Land Pattern Recommendation

NOTICE

AM'S PRODUCTS ARE NOT AUTHORIZED FOR USE AS COMPONENTS IN ANY LIFE SUPPORT DEVICES OR SYSTEMS.

AM reserve the right to make modifications, enhancements, improvements, corrections or other changes without further notice to any product herein. AM does not assume any liability arising out of the application or use of any product described herein.

X-ON Electronics

Largest Supplier of Electrical and Electronic Components

Click to view similar products for [Zener Diodes](#) category:

Click to view products by [amsem](#) manufacturer:

Other Similar products are found below :

[RKZ13B2KG#P1](#) [DL5234B](#) [1N4682](#) [1N4693](#) [1N4732A](#) [1N4736A](#) [1N4750A](#) [1N4759ARL](#) [1N5241B](#) [1N5365B](#) [1N5369B](#) [1N747A](#)
[1N964B](#) [1N966B](#) [1N968B](#) [1N972B](#) [JANS1N4974US](#) [1N4692](#) [1N4702](#) [1N4704](#) [1N4711](#) [1N4714](#) [1N4745ARL](#) [1N4752ARL](#) [1N4760ARL](#)
[1N5221B](#) [1N5242BTR](#) [1N5350B](#) [1N5352B](#) [1N961BRR1](#) [1N964BRL](#) [RKZ5.1BKU#P6](#) [3SMAJ5946B-TP](#) [3SMAJ5950B-TP](#)
[MMSZ5230BQ-13-F](#) [MMSZ5232BQ-13-F](#) [BZX84C7V5](#) [3SMAJ5945B-TP](#) [3SMAJ5947B-TP](#) [3SMBJ5941B-TP](#) [DZ2S240M0L](#) [SMAZ27-](#)
[TP](#) [ZMM5224B-7](#) [RD16UM-T1-A](#) [RD39S-T1-A](#) [RD10S-T1-A](#) [CDZT2R5.6B](#) [1N4762A G](#) [Z1SMA18](#) [JANTX1N4553B](#)