

Zener Diodes / DATA SHEET

M3Z2V0C – M3Z75VC series

- ◇ Constant Voltage control
 - ◇ Wide Voltage Range Selection 2.0V to 75V
 - ◇ Vz tolerance selection of $\pm 5\%$ (C series)
 - ◇ SOD323F Thin SMD package
 - ◇ RoHS compliant / Green EMC
 - ◇ Matte Tin (Sn) Lead finish
 - ◇ Cathode Band / Device marking
- Refer to table list

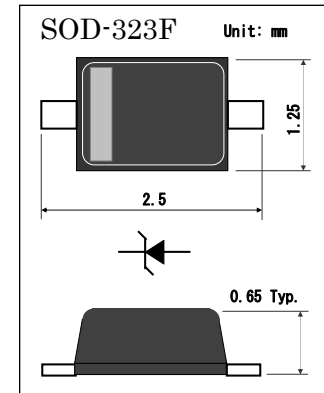

Maximum Ratings (Ta = 25 °C)

Symbol	Parameter	Value	Units
P_D	Power Dissipation	200	mW
T_J	Junction Temperature	150	°C
T_{STG}	Storage Temperature	-55 to +125	°C
I_{ZM}	Maximum Regulator Current	P_D/V_Z	mA

Electrical Characteristics (Ta = 25 °C)

Type Number	Device Marking	Vz (V) *1			Zzt(Ω) max.	Iz (mA)	Zzk(Ω) max.	Izk (mA)	IR(μA) max.	VR (V)
		min.	typ.	max.						
M3Z2V0C	2v0	1.90	2.0	2.10	100	5	600	1	120	1.0
M3Z2V2C	2v2	2.09	2.2	2.31	100	5	600	1	120	1.0
M3Z2V4C	2v4	2.20	2.4	2.60	90	5	600	1	120	1.0
M3Z2V7C	2v7	2.50	2.7	2.90	90	5	600	1	100	1.0
M3Z3V0C	3v0	2.80	3.0	3.20	85	5	600	1	50	1.0
M3Z3V3C	3v3	3.10	3.3	3.50	85	5	600	1	20	1.0
M3Z3V6C	3v6	3.40	3.6	3.80	85	5	600	1	10	1.0
M3Z3V9C	3v9	3.70	3.9	4.10	85	5	600	1	5	1.0
M3Z4V3C	4v3	4.00	4.3	4.60	80	5	600	1	5	1.0
M3Z4V7C	4v7	4.40	4.7	5.00	70	5	500	1	2	1.0
M3Z5V1C	5v1	4.80	5.1	5.40	50	5	480	1	2	1.5

Continued next page

Device No	Device Marking	V _z (V) *1			Z _{zt} (Ω)	I _z	Z _{zk} (Ω)	I _{zk}	I _R (μA)	V _R (V)
		min.	typ.	max.	max.	(mA)	max.	(mA)	max.	
M3Z5V6C	5v6	5.32	5.6	5.88	30	5	400	1	1	2.0
M3Z6V2C	6v2	5.89	6.2	6.51	10	5	150	1	1	3.0
M3Z6V8C	6v8	6.46	6.8	7.14	10	5	80	1	0.5	4.0
M3Z7V5C	7v5	7.11	7.5	7.86	10	5	50	1	0.5	5.0
M3Z8V2C	8v2	7.79	8.2	8.61	10	5	50	1	0.5	6.0
M3Z9V1C	9v1	8.65	9.1	9.56	10	5	50	1	0.5	7.0
M3Z10VC	10	9.50	10.0	10.50	15	5	70	1	0.1	7.5
M3Z11VC	11	10.45	11.0	11.55	20	5	70	1	0.1	8.0
M3Z12VC	12	11.40	12.0	12.60	20	5	90	1	0.1	9.0
M3Z13VC	13	12.35	13.0	13.65	26	5	110	1	0.1	10
M3Z15VC	15	14.25	15.0	15.75	30	5	110	1	0.1	11
M3Z16VC	16	15.20	16.0	16.80	40	5	170	1	0.1	12
M3Z18VC	18	17.10	18.0	18.90	45	5	170	1	0.1	14
M3Z20VC	20	19.00	20.0	21.00	55	5	220	1	0.1	15
M3Z22VC	22	20.90	22.0	23.10	55	5	220	1	0.1	17
M3Z24VC	24	22.80	24.0	25.20	70	5	220	1	0.1	19
M3Z27VC	27	25.65	27.0	28.35	80	5	220	1	0.1	20
M3Z30VC	30	28.50	30.0	31.50	80	5	220	1	0.1	22
M3Z33VC	33	31.35	33.0	34.65	80	5	220	1	0.1	24
M3Z36VC	36	34.20	36.0	37.80	80	5	220	1	0.1	27
M3Z39VC	39	37.05	39.0	40.95	90	2.5	500	0.5	0.1	29
M3Z43VC	43	40.85	43.0	45.15	90	2.5	600	0.5	0.1	32
M3Z47VC	47	44.65	47.0	49.35	110	2.5	700	0.5	0.1	35
M3Z51VC	51	48.45	51.0	53.55	125	2.5	700	0.5	0.1	38
M3Z56VC	56	53.20	56.0	58.80	135	2.5	1000	0.5	0.1	42
M3Z62VC	62	58.90	62.0	65.10	150	2.5	1000	0.5	0.1	47
M3Z68VC	68	64.60	68.0	71.40	200	2.5	1000	0.5	0.1	51
M3Z75VC	75	71.25	75.0	78.75	250	2.5	1500	0.5	0.1	56

*1 Pulse width = 10 ms

Typical Characteristics

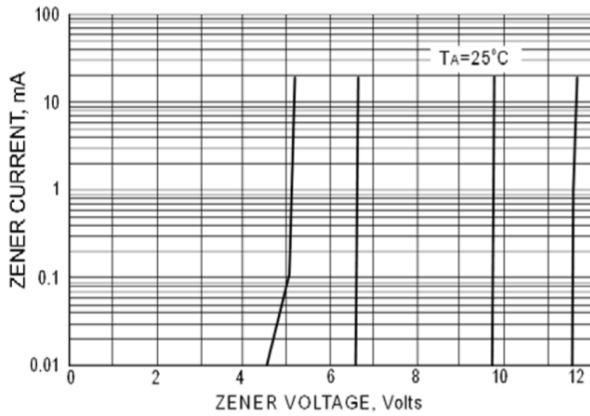

ZENER BREAKDOWN CHARACTERISTIC

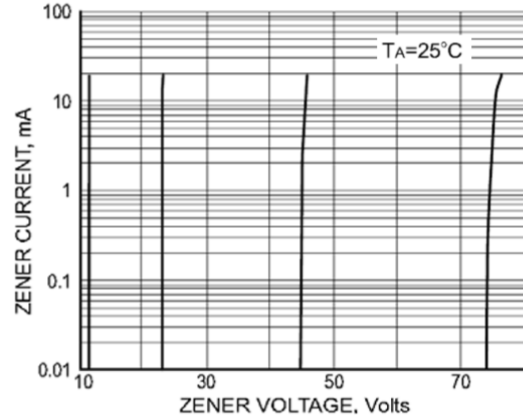

ZENER BREAKDOWN CHARACTERISTICS

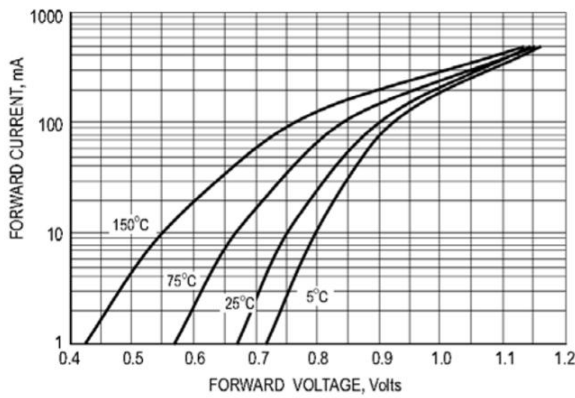

TYPICAL FORWARD VOLTAGE

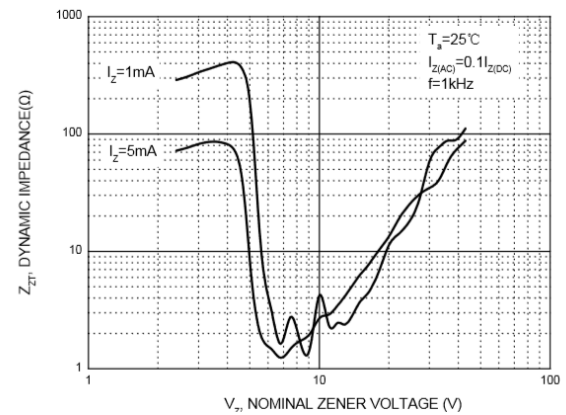

Effect of Zener Voltage on Zener Impedance

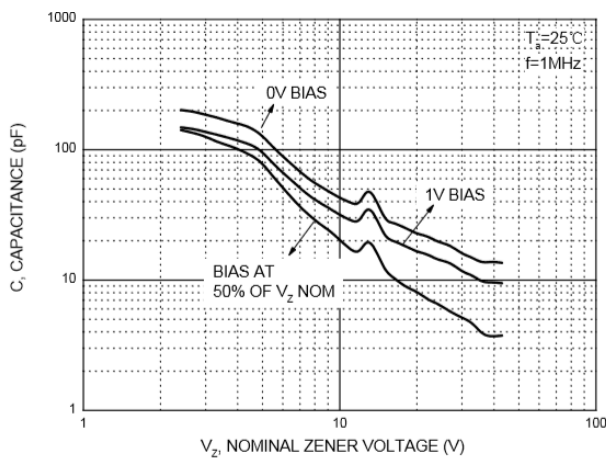

Typical Capacitance

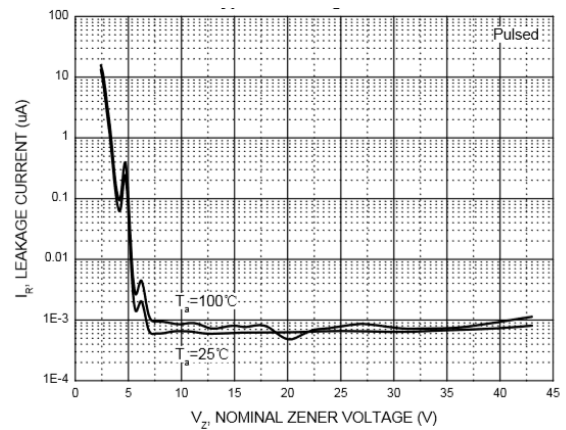

Typical Leakage Current

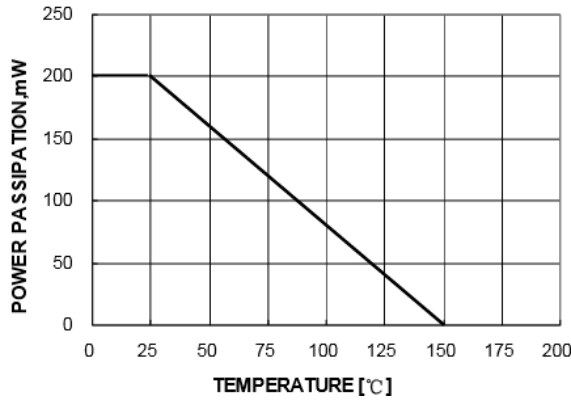

Ordering Information

Device	Package	Shipping	Tape wide	Emboss pitch	Tape specification	Notes
M3Z2V0C – M3Z75VC series	SOD323F	Tape & Reel 3000pcs /7” Reel	8 mm	4 mm	Conductive	

Package Dimensions

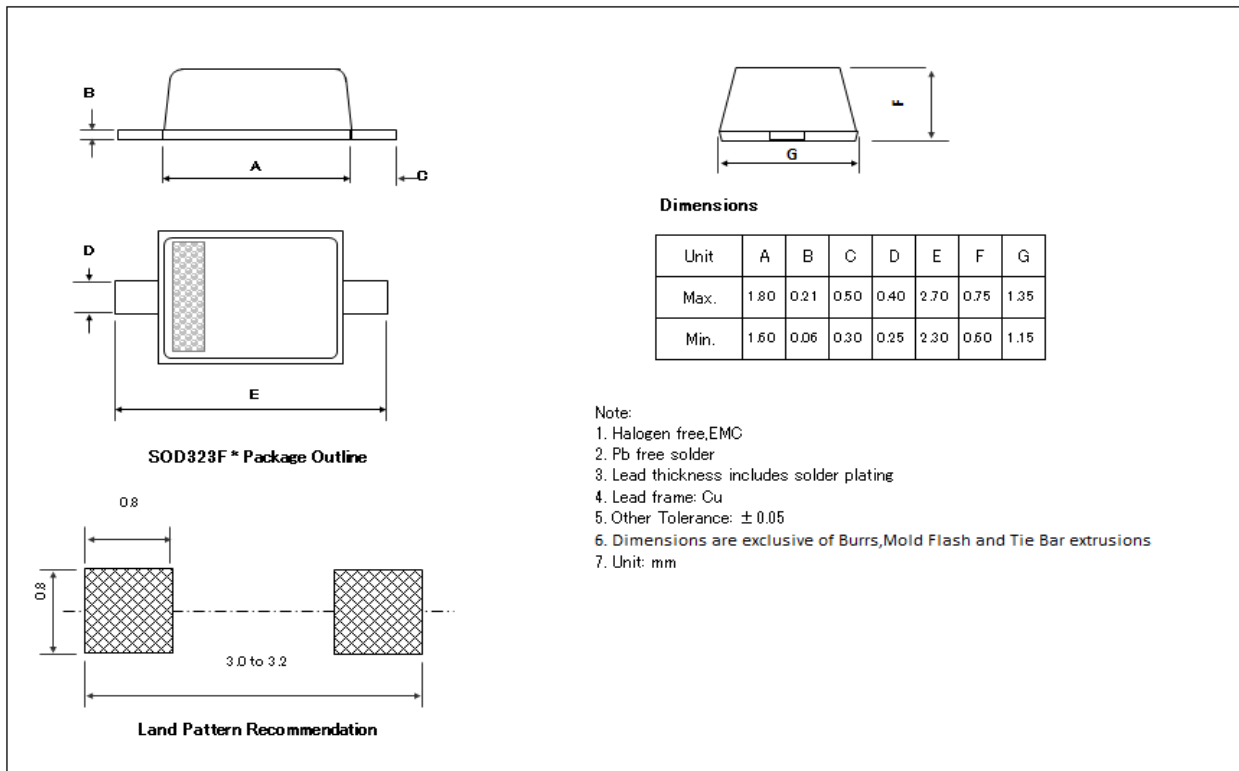

NOTICE

AM'S PRODUCTS ARE NOT AUTHORIZED FOR USE AS COMPONENTS IN ANY LIFE SUPPORT DEVICES OR SYSTEMS.

AM reserve the right to make modifications, enhancements, improvements, corrections or other changes without further notice to any product herein. AM does not assume any liability arising out of the application or use of any product described herein.

X-ON Electronics

Largest Supplier of Electrical and Electronic Components

Click to view similar products for [Zener Diodes](#) category:

Click to view products by [amsem](#) manufacturer:

Other Similar products are found below :

[RKZ13B2KG#P1](#) [DL5234B](#) [1N4682](#) [1N4693](#) [1N4732A](#) [1N4736A](#) [1N4750A](#) [1N4759ARL](#) [1N5241B](#) [1N5365B](#) [1N5369B](#) [1N747A](#)
[1N964B](#) [1N966B](#) [1N968B](#) [1N972B](#) [JANS1N4974US](#) [1N4692](#) [1N4702](#) [1N4704](#) [1N4711](#) [1N4714](#) [1N4745ARL](#) [1N4752ARL](#) [1N4760ARL](#)
[1N5221B](#) [1N5242BTR](#) [1N5350B](#) [1N5352B](#) [1N961BRR1](#) [1N964BRL](#) [RKZ5.1BKU#P6](#) [3SMAJ5946B-TP](#) [3SMAJ5950B-TP](#)
[MMSZ5230BQ-13-F](#) [MMSZ5232BQ-13-F](#) [BZX84C7V5](#) [3SMAJ5945B-TP](#) [3SMAJ5947B-TP](#) [3SMBJ5941B-TP](#) [DZ2S240M0L](#) [SMAZ27-](#)
[TP](#) [ZMM5224B-7](#) [RD16UM-T1-A](#) [RD39S-T1-A](#) [RD10S-T1-A](#) [CDZT2R5.6B](#) [1N4762A G](#) [Z1SMA18](#) [JANTX1N4553B](#)