

Transient Voltage Suppressors

Features

- ◆ 600W peak pulse power capability at 10/1000 μ s waveform, Repetition rate (duty cycle):0.01%
- ◆ For surface mounted applications to optimize board space
- ◆ Low incremental surge impedance
- ◆ Excellent clamping capability
- ◆ Photo Glass and LPCVD process
- ◆ Fast response time: typically less than 1ps from 0V to BV min.
- ◆ Typical I_R less than 1 μ A above 12V.
- ◆ High Temperature soldering guaranteed: 260 $^{\circ}$ C/40 seconds at terminals
- ◆ Plastic package has underwriters laboratory flammability 94V-0
- ◆ Meets MSL level 1, per J-STD-020.
- ◆ Meet Halogen free and RoHS compliant
- ◆ AEC-Q101 qualified available
- ◆ Automotive product No.: base P/N-H

Mechanical Data

- ◆ Case: JEDEC DO-214AA
- ◆ Polarity: Color band denotes positive end (cathode) except bi-directional models
- ◆ Weight: About 0.098g

Partnumber Coding System

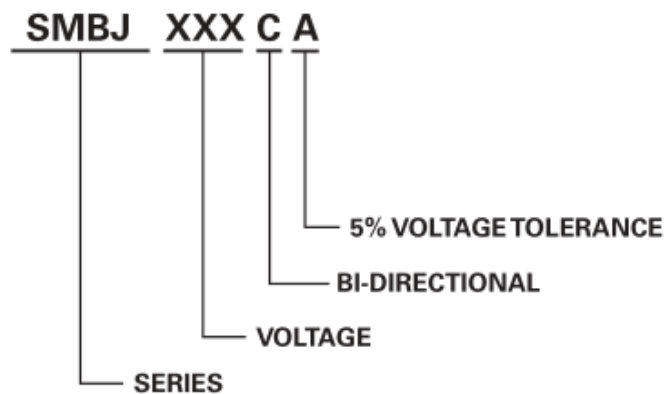

Application

- ◆ For Bi-directional devices, use suffix C or CA(e.g.SMBJ10C,SMBJ10CA).
- ◆ Electrical characteristics apply in both directions.

Uni-directional

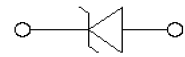
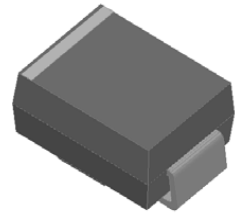

Bi-directional

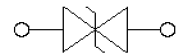
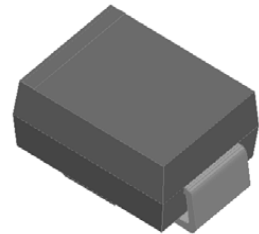

Maximum Ratings and Characteristics

Parameters at 25°C ambient temperature unless otherwise Noted.

Rating	Symbol	Value	Units
Peak pulse power dissipation at 10/1000μs waveform (Note1, Note2, Fig.1)	P_{PPM}	Minimum 600	Watts
Peak pulse current of at 10/1000μs waveform (Note 1, Fig.3)	I_{PPM}	See Table	Amps
Steady state power dissipation at $T_A=50^\circ\text{C}$ (Fig.5)	$P_{M(AV)}$	5.0	Watts
Maximum Instantaneous Forward Voltage at 50A for Unidirectional Only	VF	3.5	V
Peak forward surge current, 8.3ms single half sine-wave superimposed on rated load, (JEDEC Method) (Note3, Fig.6)	I_{FSM}	100	Amps
Operating junction and Storage Temperature Range.	T_J, T_{STG}	-55 to +150	°C

Notes: 1. Non-repetitive current pulse, per Fig.3 and derated above $T_A=25^\circ\text{C}$ per Fig.2.

2. Mounted on 5.0mm×5.0mm copper pads to each terminal.

3. 8.3ms single half sine-wave, or equivalent square wave, duty cycle=4 pulses per minutes maximum.

Dimensions (DO-214AA/SMB)

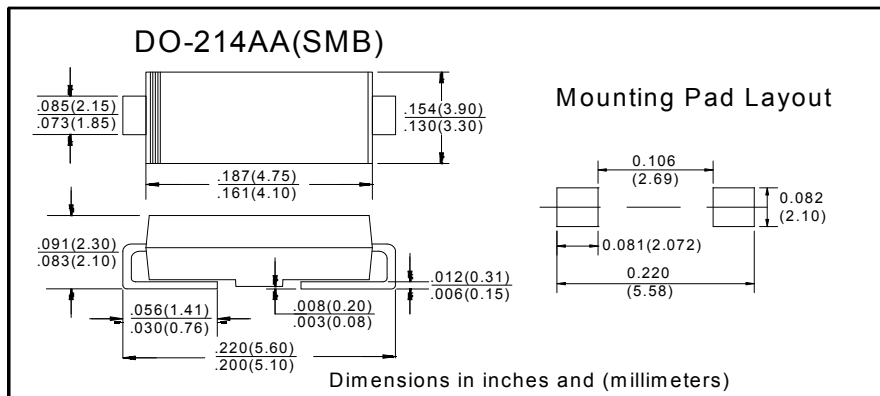

SMBJ SERIES



Electrical Characteristics

Part Number		Device Marking Code		Reverse Stand-Off Voltage	Breakdown Voltage @ I_T	Test Current	Maximum Clamping Voltage @ I_{PP}	Peak Pulse Current	Reverse Leakage @ V_{RWM}
Unidirectional	Bidirectional	UNI	BI	$V_{RWM}(V)$	$V_{BR}(V)$	$I_T(mA)$	$V_C(V)$	$I_{PP}(A)$	$I_R(\mu A)$
SMBJ5.0A	SMBJ5.0CA	KE	AE	5.0	6.40~7.00	10	9.2	65.3	800
SMBJ6.0A	SMBJ6.0CA	KG	AG	6.0	6.67~7.37	10	10.3	58.3	800
SMBJ6.5A	SMBJ6.5CA	KK	AK	6.5	7.22~7.98	10	11.2	53.6	500
SMBJ7.0A	SMBJ7.0CA	KM	AM	7.0	7.78~8.60	10	12.0	50.0	200
SMBJ7.5A	SMBJ7.5CA	KP	AP	7.5	8.33~9.21	1	12.9	46.6	100
SMBJ8.0A	SMBJ8.0CA	KR	AR	8.0	8.89~9.83	1	13.6	44.2	50
SMBJ8.5A	SMBJ8.5CA	KT	AT	8.5	9.44~10.40	1	14.4	41.7	20
SMBJ9.0A	SMBJ9.0CA	KV	AV	9.0	10.00~11.10	1	15.4	39.0	10
SMBJ10A	SMBJ10CA	KX	AX	10.0	11.10~12.30	1	17.0	35.3	5
SMBJ11A	SMBJ11CA	KZ	AZ	11.0	12.20~13.50	1	18.2	33.0	1
SMBJ12A	SMBJ12CA	LE	BE	12.0	13.30~14.70	1	19.9	30.2	1
SMBJ13A	SMBJ13CA	LG	BG	13.0	14.40~15.90	1	21.5	28.0	1
SMBJ14A	SMBJ14CA	LK	BK	14.0	15.60~17.20	1	23.2	25.9	1
SMBJ15A	SMBJ15CA	LM	BM	15.0	16.70~18.50	1	24.4	24.6	1
SMBJ16A	SMBJ16CA	LP	BP	16.0	17.80~19.70	1	26.0	23.1	1
SMBJ17A	SMBJ17CA	LR	BR	17.0	18.90~20.90	1	27.6	21.8	1
SMBJ18A	SMBJ18CA	LT	BT	18.0	20.00~22.10	1	29.2	20.6	1
SMBJ20A	SMBJ20CA	LV	BV	20.0	22.20~24.50	1	32.4	18.6	1
SMBJ22A	SMBJ22CA	LX	BX	22.0	24.40~26.90	1	35.5	16.9	1
SMBJ24A	SMBJ24CA	LZ	BZ	24.0	26.70~29.50	1	38.9	15.5	1
SMBJ26A	SMBJ26CA	ME	CE	26.0	28.90~31.90	1	42.1	14.3	1
SMBJ28A	SMBJ28CA	MG	CG	28.0	31.10~34.40	1	45.4	13.3	1
SMBJ30A	SMBJ30CA	MK	CK	30.0	33.30~36.80	1	48.4	12.4	1
SMBJ33A	SMBJ33CA	MM	CM	33.0	36.70~40.60	1	53.3	11.3	1
SMBJ36A	SMBJ36CA	MP	CP	36.0	40.00~44.20	1	58.1	10.4	1
SMBJ40A	SMBJ40CA	MR	CR	40.0	44.40~49.10	1	64.5	9.3	1
SMBJ43A	SMBJ43CA	MT	CT	43.0	47.80~52.80	1	69.4	8.7	1
SMBJ45A	SMBJ45CA	MV	CV	45.0	50.00~55.30	1	72.7	8.3	1
SMBJ48A	SMBJ48CA	MX	CX	48.0	53.30~58.90	1	77.4	7.8	1
SMBJ51A	SMBJ51CA	MZ	CZ	51.0	56.70~62.70	1	82.4	7.3	1
SMBJ54A	SMBJ54CA	NE	DE	54.0	60.00~66.30	1	87.1	6.9	1
SMBJ58A	SMBJ58CA	NG	DG	58.0	64.40~71.20	1	93.6	6.5	1
SMBJ60A	SMBJ60CA	NK	DK	60.0	66.70~73.70	1	96.8	6.2	1
SMBJ64A	SMBJ64CA	NM	DM	64.0	71.10~78.60	1	103	5.9	1
SMBJ70A	SMBJ70CA	NP	DP	70.0	77.80~86.00	1	113	5.3	1
SMBJ75A	SMBJ75CA	NR	DR	75.0	83.30~92.10	1	121	5.0	1

SMBJ SERIES



Part Number		Device Marking Code		Reverse Stand-Off Voltage	Breakdown Voltage @ I_T	Test Current	Maximum Clamping Voltage @ I_{PP}	Peak Pulse Current	Reverse Leakage @ V_{RWM}
Unidirectional	Bidirectional	UNI	BI	$V_{RWM}(V)$	$V_{BR}(V)$	$I_T(mA)$	$V_C(V)$	$I_{PP}(A)$	$I_R(\mu A)$
SMBJ78A	SMBJ78CA	NT	DT	78.0	86.70~95.80	1	126.0	4.8	1
SMBJ85A	SMBJ85CA	NV	DV	85.0	94.40~104.00	1	137.0	4.4	1
SMBJ90A	SMBJ90CA	NX	DX	90.0	100.00~111.00	1	146.0	4.1	1
SMBJ100A	SMBJ100CA	NZ	DZ	100.0	111.00~123.00	1	162.0	3.7	1
SMBJ110A	SMBJ110CA	PE	EE	110.0	122.00~135.00	1	177.0	3.4	1
SMBJ120A	SMBJ120CA	PG	EG	120.0	133.00~147.00	1	193.0	3.1	1
SMBJ130A	SMBJ130CA	PK	EK	130.0	144.00~159.00	1	209.0	2.9	1
SMBJ150A	SMBJ150CA	PM	EM	150.0	167.00~185.00	1	243.0	2.5	1
SMBJ160A	SMBJ160CA	PP	EP	160.0	178.00~197.00	1	259.0	2.3	1
SMBJ170A	SMBJ170CA	PR	ER	170.0	189.00~209.00	1	275.0	2.2	1
SMBJ180A	SMBJ180CA	PT	ET	180.0	201.00~222.00	1	292.0	2.1	1
SMBJ190A	SMBJ190CA	PA	EC	190.0	211.00~233.00	1	308.0	2.0	1
SMBJ200A	SMBJ200CA	PV	EV	200.0	224.00~247.00	1	324.0	1.9	1
SMBJ220A	SMBJ220CA	PX	EX	220.0	246.00~272.00	1	340.0	1.7	1
SMBJ250A	SMBJ250CA	PZ	EZ	250.0	279.00-309.00	1	405.0	1.5	1
SMBJ300A	SMBJ300CA	QE	FE	300.0	335.00-371.00	1	486.0	1.3	1
SMBJ350A	SMBJ350CA	QG	FG	350.0	391.00-432.00	1	567.0	1.1	1
SMBJ400A	SMBJ400CA	QK	FK	400.0	447.00-494.00	1	648.0	0.9	1
SMBJ440A	SMBJ440CA	QM	FM	440.0	492.00-543.00	1	713.0	0.9	1

Notes: For bidirectional type having V_{RWM} of 10V and less, the I_R limit is double.

Ratings and Characteristic Curves($T_A=25^{\circ}\text{C}$ unless otherwise noted)

Figure 1. Peak Pulse Power Rating Curve

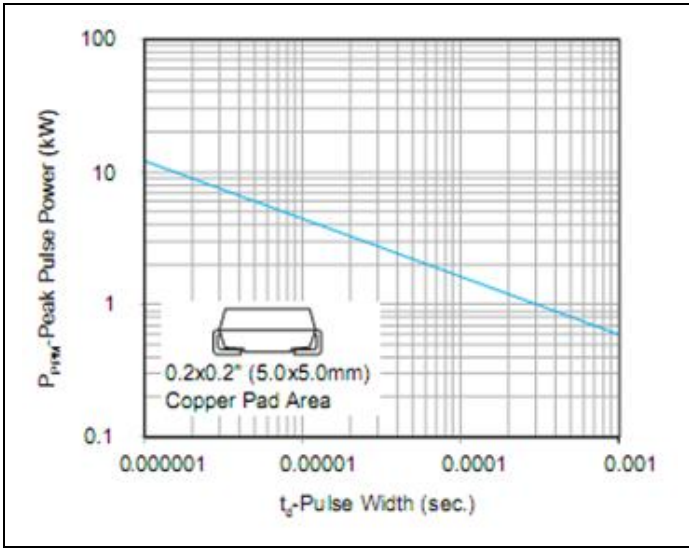

Figure 2. Pulse Derating Curve

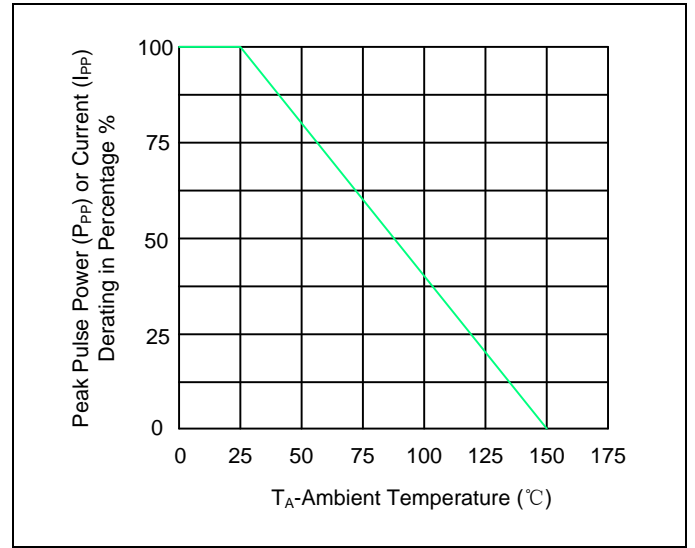

Figure 3. Pulse Waveform

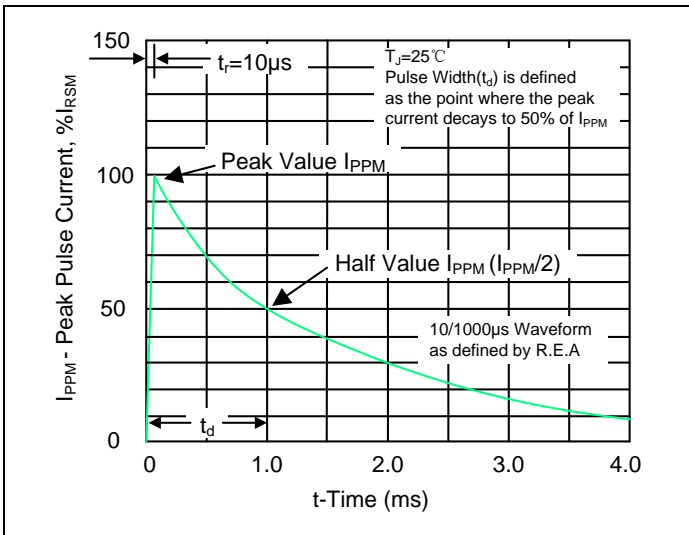

Figure 4. Typical Junction Capacitance

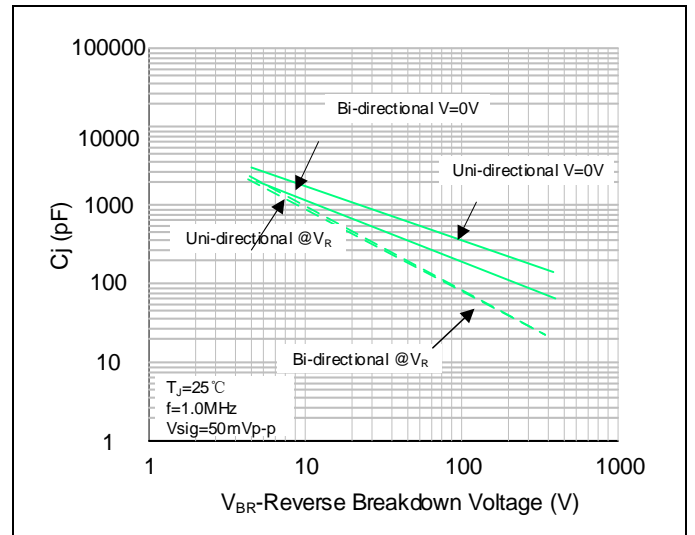

Figure 5. Steady State Power Dissipation Derating Curve

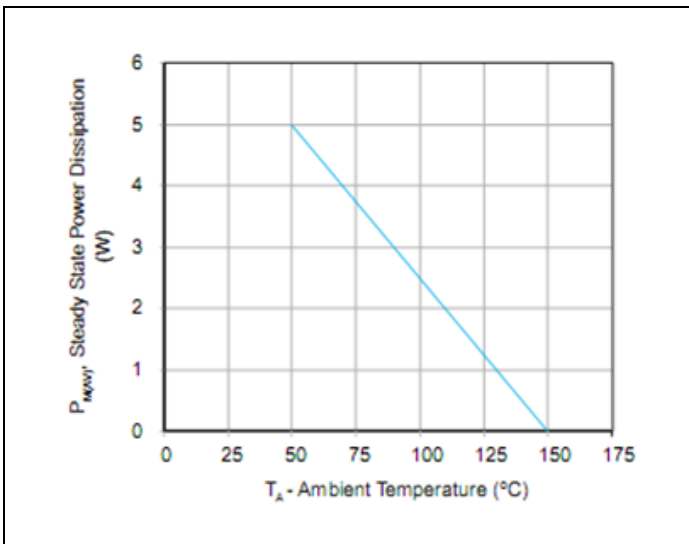
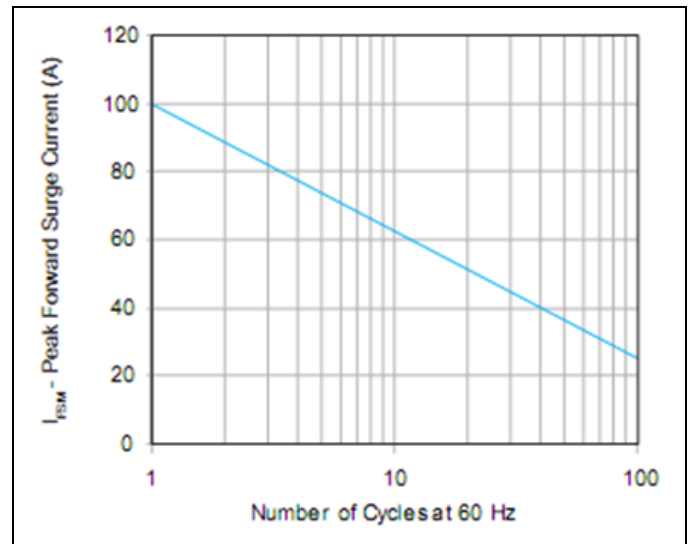
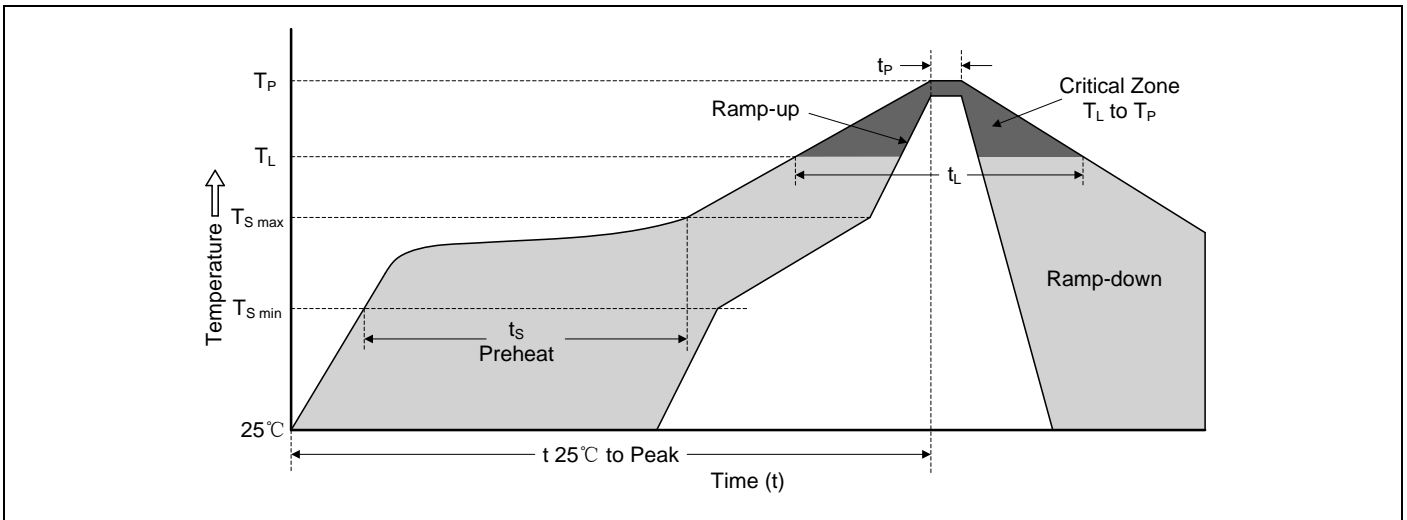

Figure 6. Maximum Non-Repetitive Forward Surge Current



Reflow Soldering Parameters



Reflow Condition		Lead-free Assembly
Pre heat	-Temperature Min (T _{S min})	150°C
	-Temperature Max (T _{S max})	200°C
	-Time (min to max) (t _s)	60-180 seconds
Average ramp-up rate (T _L to T _P)		3°C/second max.
T _{S max} to T _L -Ramp-up Rate		3°C/second max.
Reflow	-Temperature (T _L) (Liquidus)	217°C
	-Time (min to max) (t _s)	60-150 seconds
Peak Temperature (T _P)		260(+0/-5)°C
Time within 5°C of actual Peak Temperature (t _p)		20-40 seconds
Ramp-down Rate		6°C/second max.
Time 25°C to Peak Temperature		8 minutes max.
Do not exceed		280°C

Reliability

	Standards
Terminal strength	MIL-STD-750 Method 2026
Mechanical shock	JESD22-B104
Vibration	JESD22-B103
High Temp. Storage	JESD22-A103
High Temp Reverse Bias	JESD22-A108
Temperature Cycling	JESD22-A104
High Temp High humidity Reverse Bias	JESD22-A101
Resistance to solder heat	JESD22-B106

Packaging

Part number	Component Package	Quantity	Packaging Option	Packaging Specification
SMBJxxxXX	DO-214AA	3000	Tape & Reel-12mm tape/13" reel	EIA STD RS-481
SMBJxxxXX-T7	DO-214AA	500	Tape & Reel-12mm tape/7" reel	EIA STD RS-481

Tape and Reel Specification

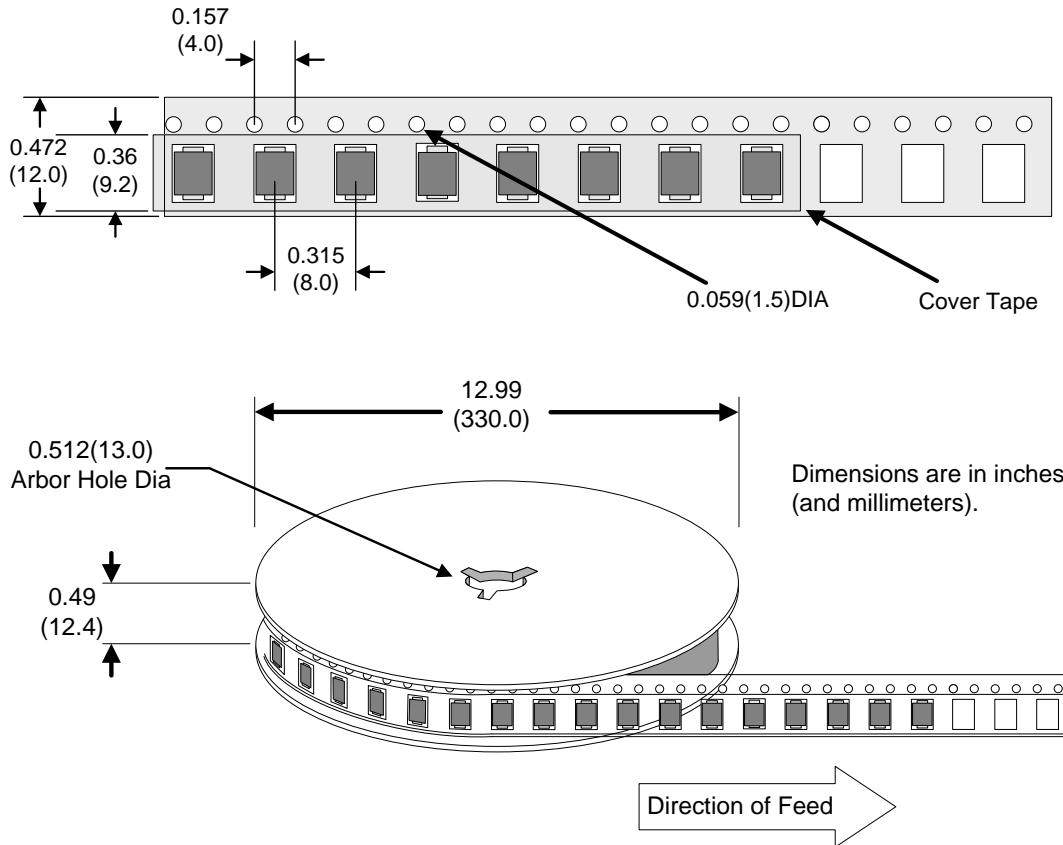

IMPORTANT NOTICE AND DISCLAIMER

AM RESERVES THE RIGHT TO MAKE CHANGES TO ALL PRODUCT, PRODUCT SPECIFICATIONS AND DATA WITHOUT NOTICE TO IMPROVE RELIABILITY, FUNCTION OR DESIGN OR OTHERWISE. CUSTOMERS SHOULD OBTAIN AND CONFIRM THE LATEST PRODUCT INFORMATION AND SPECIFICATIONS BEFORE FINAL DESIGN PURCHASE OR USE.

AM disclaim any and all liability for any errors, inaccuracies or incompleteness contained in any datasheet or in any other disclosure relating to any product.

All information are provided as-is, even it has qualified by the AEC-Q101 which satisfy industrial application requirement, except as expressly stated in this data sheet is applied for automotive grade, AM make no warranties, representation or guarantee, whether express, implied or statutory, including, without limitation, regarding any merchantability, satisfactory quality, or fitness for a particular purpose with respect to AM.

AM does not assume any liability or compensation for any application assistance or customer product design, and make no warranty or accept any liability with products, which are purchased or used for any unintended or unauthorized application.

Except as expressly indicated in writing, AM products are not designed for use in medical, life-saving, or lifesustaining applications or for any other application in which the failure of the AM product could result in personal injury or death. Customers using or selling AM products not expressly indicated for use in such applications do so at their own risk. Please contact authorized AM personnel to obtain written terms and conditions regarding products designed for such applications.

No license, express or implied, by estoppel or otherwise, to any intellectual property rights is granted by this document or by any conduct of AM. Product names and markings noted herein may be trademarks of their respective owners.

X-ON Electronics

Largest Supplier of Electrical and Electronic Components

Click to view similar products for [ESD Suppressors / TVS Diodes](#) category:

Click to view products by [amsem](#) manufacturer:

Other Similar products are found below :

[60KS200C](#) [D18V0L1B2LP-7B](#) [D5V0F4U5P5-7](#) [NTE4902](#) [P4KE27CA](#) [P6KE11CA](#) [P6KE8.2A](#) [SA60CA](#) [SA64CA](#) [SMBJ12CATR](#)
[SMBJ33CATR](#) [SMBJ6.5A](#) [SMBJ8.0A](#) [ESD101-B1-02ELS](#) [E6327](#) [ESD112-B1-02EL](#) [E6327](#) [ESD7451N2T5G](#) [19180-510](#) [CPDT-5V0USP-](#)
[HF](#) [3.0SMCJ33CA-F](#) [3.0SMCJ36A-F](#) [HSPC16701B02TP](#) [JANTX1N6126A](#) [D3V3Q1B2DLP3-7](#) [D55V0M1B2WS-7](#) [SCM1293A-04SO](#)
[ESD200-B1-CSP0201](#) [E6327](#) [SM12-7](#) [CEN955](#) [W/DATA](#) [VESD12A1A-HD1-GS08](#) [CPDQC5V0-HF](#) [D1213A-01LP4-7B](#) [ESD101-B1-02EL](#)
[E6327](#) [AOZ8808DI-03](#) [5KP15A](#) [5KP48A](#) [5KP90A](#) [ESD3V3D7-TP](#) [15KPA36A-LF](#) [P4KE56CA](#) [P4KE68A](#) [P4KE91CATR](#) [P6KE120A](#)
[P6KE13CA](#) [P6KE43CA](#) [P6KE6.8CA](#) [P6KE8.2](#) [P6SMBJ20CA](#) [JANTX1N6072A](#) [SR2835ESKG](#) [SA90CA](#)