

Silencer

Compact Resin Type/Male Thread

Series AN05 to 40

RoHS



How to Order

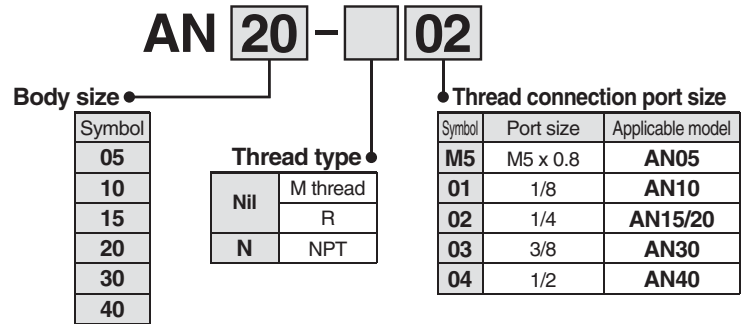

Specifications

Fluid	Compressed air
Max. operating pressure ^{Note 1)}	145psi (1.0 MPa)
Noise reduction	30 dB(A) ^{Note 2)}
Ambient and fluid temperature	41 to 140°F (5 to 60°C) ^{Note 3)}

Note 1) It indicates the inlet pressure for solenoid valve.

Note 2) The value may vary, depending on the pneumatic circuit or pressure that is exhausted from the solenoid valve.

Note 3) The product can be used in temperatures 14 to 140°F (-10 to 60°C) if there is no risk of water droplets forming and freezing.

Refer to page 5 for Precautions on these products.

Performance

Model	Effective area mm ²	Sonic conductance C [dm ³ /(s·bar)]	Recommended flow m ³ /min(ANR)	Weight g
AN05-M5	5	1	0.4 or less	0.5
AN10-01	10	2	0.8 or less	1
AN15-02	15	3	1.0 or less	2.5
AN20-02	35	7	3.0 or less	4
AN30-03	60	12	5.0 or less	5.5
AN40-04	90	18	8.0 or less	8.5

Note) Recommended flow rate is the flow at 72.5psi (0.5 MPa) in the inlet pressure.

Construction/Parts/Dimensions

AN05/10/20

AN15/30/40

No hexagonal part
in AN05 and AN10

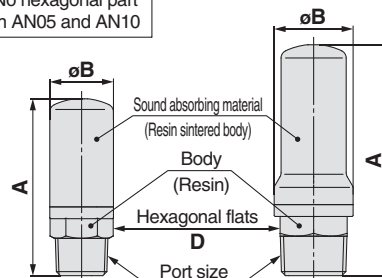

Dimensions

Model	Port size R, NPT	A	B	D	(mm)
AN05-M5	M5 x 0.8	15	6.5	—	
AN10-01	1/8	23	11	—	
AN15-02	1/4	32	16	14	
AN20-02	1/4	45	16.5	14	
AN30-03	3/8	58.5	20	17	
AN40-04	1/2	68	24	21	

Silencer

Compact Resin Type/One-touch Fitting Connection

Series AN10 to 30-C RoHS



How to Order

AN **20** - C **10**

Body size

Symbol
10
15
20
30

Applicable one-touch fitting size

Symbol	Port size	Applicable model
06	ø6	AN10
07	ø1/4	AN10
08	ø8	AN15
10	ø10	AN20
11	ø3/8	AN20
12	ø12	AN30

Connection type

Symbol	Connection type
C	One-touch fitting connection

Specifications

Fluid	Compressed air
Max. operating pressure ^{Note 1)}	145psi (1.0 MPa)
Noise reduction	30 dB(A) ^{Note 2)}
Ambient and fluid temperature	41 to 140°F (5 to 60°C) ^{Note 3)}

Note 1) It indicates the inlet pressure for solenoid valve.

Note 2) The value may vary, depending on the pneumatic circuit or pressure that is exhausted from the solenoid valve.

Note 3) The product can be used in temperatures 14 to 140°F (-10 to 60°C) if there is no risk of water droplets forming and freezing.

Refer to page 5 for Precautions on these products.

Performance

Model	Effective area mm ²	Sonic conductance C [dm ³ /(s·bar)]	Recommended flow m ³ /min(ANR)	Weight g
AN10-C06	7	1.4	0.8 or less	1
AN10-C07				1
AN15-C08	20	4	3.0 or less	1.4
AN20-C10	30	6	5.0 or less	3.5
AN20-C11	25	5	3.0 or less	3.5
AN30-C12	41	8.2	5.0 or less	5

Note) Recommended flow rate is the flow at 72.5psi (0.5 MPa) in the inlet pressure.

Construction/Parts/Dimensions

AN10-C to 30-C

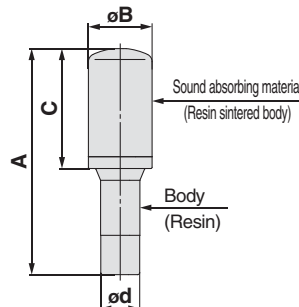

Dimensions

Model	A	B	C	ød
AN10-C06	36.5	11	14.5	ø6
AN10-C07				ø1/4
AN15-C08	45	13	20	ø8
AN20-C10	57.5	16.5	30.5	ø10
AN20-C11				ø3/8
AN30-C12	71.5	20	43.5	ø12

Silencer

Metal Body Type

Series AN□00

RoHS

Noise reduction 30 dB(A)
Low back pressure
Easy mounting



How to Order

AN 500 - □ 06

Body size

Symbol
500
600
700
800
900

Thread type

Symbol	Type
Nil	R
N	NPT

Port size

Symbol	Port size	Applicable model
06	3/4	AN500
10	1	AN600
12	1 1/4	AN700
14	1 1/2	AN800
20	2	AN900

Specifications

Fluid	Compressed air
Max. operating pressure ^{Note 1)}	145psi (1.0 MPa)
Noise reduction	30 dB(A) ^{Note 2)}
Ambient and fluid temperature	41 to 140°F (5 to 60°C) ^{Note 3)}

Note 1) It indicates the inlet pressure for solenoid valve.

Note 2) The value may vary, depending on the pneumatic circuit or pressure that is exhausted from the solenoid valve.

Note 3) The product can be used in temperatures 14 to 140°F (-10 to 60°C) if there is no risk of water droplets forming and freezing.

Refer to page 5 for Precautions on these products.

Performance

Model	Effective area mm ²	Sonic conductance C [dm ³ /(s·bar)]	Recommended flow m ³ /min(ANR)	Weight g
AN500-06	160	32	12 or less	165
AN600-10	270	54	20 or less	220
AN700-12	440	88	30 or less	435
AN800-14	590	118	50 or less	510
AN900-20	960	192	80 or less	740

Note) Recommended flow rate is the flow at 72.5psi (0.5 MPa) in the inlet pressure.

Construction/Parts/Dimensions

AN500 to 900

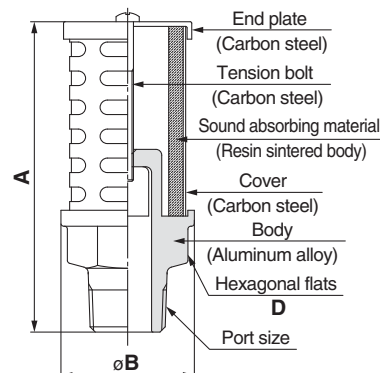

Dimensions

Model	Port size R, NPT	A	B	D
AN500-06	3/4	107	46	36
AN600-10	1	127	50	41
AN700-12	1 1/4	186	74	50
AN800-14	1 1/2	217	74	55
AN900-20	2	256	86	65



Series AN

Specific Product Precautions

Be sure to read before handling. Refer to back cover for Safety Instructions.

Design

Warning

1. The silencer clogging may result in a blocked exhaust port.

Provide a safety design so as not to cause the whole system to malfunction.

Caution

1. The silencer is intended to reduce the noise of compressed air that is exhausted from the pneumatic equipment.

Since noises generated by sources other than the exhaust, such as noise generated inside piping, equipment vibration and solenoid valve switching, cannot be reduced, locate the cause of these noises and take countermeasures.

The product does not function as a filter. Do not use the product as a filter regardless of negative and positive pressures.

2. If the compressed air supply is contaminated with fluids such as oil and oil mist, such fluids will be dispersed to the environment.

In such a case, an exhaust cleaner is recommended to recover fluids and reduce noise.

3. The value of the noise reduction may vary, depending on the pneumatic circuit or pressure that is exhausted from the solenoid valve.

Selection

Caution

1. When selecting the silencer, the sonic conductance* (including combined sonic conductance) of the silencer should be larger than that of the solenoid valve.

*Sonic conductance $C [dm^3/(s \cdot bar)] = \text{Effective area } [mm^2] \div 5$

2. Use within the range of specifications.

Operating Environment

Warning

1. Do not use in an atmosphere having corrosive gases, chemicals, sea water, water, water steam, or where there is direct contact with any of these.

Refer to the construction drawings for silencer materials.

2. Avoid exposure to direct sunlight.
3. Do not operate in locations where vibration or impact occurs.
4. Do not use the product in locations where it is near heat sources and exposed to radiation heat.
5. Do not use in an environment where the product is exposed to cutting oil, lubricating oil, or coolant, etc.

If it is used in an environment where there is possible contact with cutting oil, lubricating oil, or coolant, exercise preventive measures.

6. Do not use in an environment where foreign matter may stick to the product or get mixed in the product's interior.

It may result in clogging at an early stage, coming off or causing damage.

Mounting

Caution

1. If the silencer body is made of resin and is tightened too much, the silencer may be damaged.
2. Tightening by using a pipe wrench or pliers may cause damage to the silencer. This method is not recommended.

Please follow the procedures below for mounting.

When the body is made of resin

Hold the tip of the body (the side without thread) and screw it in. At the point where the thread begins to feel tight, use a wrench on the hexagonal flats to tighten an additional 1/4 turn.

Tighten the AN05-M5 by hand completely until the ends of the fitting come into contact with the mounting surface. Then apply additional tightening. Note that the additional tightening should be 30° or less. (Tighten it with 0.1 N·m or less.)

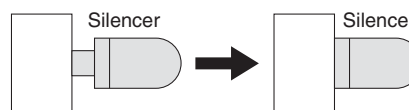

When the body is made of metal

Within the recommended tightening torque shown in the table below, use a wrench on the hexagonal flats and tighten.

Tightening Torque (Metal type)

Connection thread	Applicable tightening torque N·m
R 3/4	28 to 30
R1	36 to 38
R1 1/4	40 to 42
R1 1/2	48 to 50
R2	48 to 50

3. Make sure not to apply a lateral load to the body during or after the installation.
4. When the silencer body is loosened by vibration, etc. of equipment on which a silencer is assembled, apply glue to threads to prevent loosening and reattach.









Maintenance

Caution

1. The sound absorbing material is not replaceable. Since the sound absorbing material is not replaceable, never disassemble the product.
2. If the exhaust speed drops and the system performance decreases due to clogging, replace with a new silencer. Make sure to verify the operating conditions of the actuator at least once a day.
3. If operation continues when it is clogged, breakage can result.

Silencers/Exhaust Cleaner

Series AN□/Series AMC

	Series	Noise reduction	Nominal filtration rating (Reference values)	Oil mist removal ratio		
Silencers	Standard type Low back pressure Compact and easy mounting	Series AN□00 	30 dB (A)	100 μm 150 μm	—	Page 5-10-2
	Compact type Space-saving compact type	Series AN□03 	25 dB (A)	100 μm	—	Page 5-10-3
	Metal case type Exhaust in only one direction. Prevents scattering of mist and noise.	Series 25□□ 	19 dB (A)	—	—	Page 5-10-4
	BC sintered body type Ideal for the exhaust of a compact valve or pilot air.	AN101-01 AN110-01 AN120-M5 AN120-M3 	16 dB (A) 21 dB (A) 18 dB (A) 13 dB (A)	100 μm 70 μm	—	Page 5-10-5
	One-touch fitting connection type Can connect with One-touch fitting directly.	Series AN□□□ -KM□□ 	25 dB (A) 30 dB (A) It differs depending upon the model.	100 μm	—	Page 5-10-6
	High noise reduction type Case adopts UL94-V0 grade flame resistant material.	Series AN□02 	35 dB (A)	50 μm	—	Page 5-10-7
	High noise reduction type A high noise reduction type silencer keeps the noise level inside a plant below 85 dB (A).	Series ANA1 	40 dB (A)	30 μm	—	Page 5-10-8
	High noise reduction type Series ANB1 has a larger effective area with the same port size as Series ANA1.	Series ANB1 	38 dB (A)	30 μm	—	Page 5-10-9
Exhaust Cleaner	Series AMC 	35 dB (A)	0.3 μm	99.9%	Page 5-10-11	

VEX
AN
AMC

Precautions/Specific Product Precautions Page 5-10-13

Related Products
 Exhaust Cleaner for Vaccum (Series AMV)
 Exhaust Cleaner for Clean Room (Series AMP) Page 5-10-15

SERIES (N)AN SILENCER M3, M5, 1/8 SINTERED BRONZE

- ✓ Suitable for miniature valves and pilot air exhaust ports
- ✓ 13 - 21 dB noise reduction

TECHNICAL SPECIFICATIONS

Model	NAN101-01	NAN110-01	NAN120-M3	NAN120-M5
Port Size	1/8"	1/8"	M3	M5
Noise Reduction (dB)	16	21	13	18
Max Operating Pressure	1MPa / 145PSI			
Ambient & Fluid Temperature	5~150°C / 40~300°F			
Effective Orifice mm ² (Cv)	20 (1.1)	35 (1.9)	1 (0.05)	5 (0.27)
Weight (gf)	9.5	20	1	3.3

*Tapered thread ISO7/1

SYMBOLS

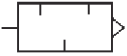

DIMENSIONS SERIES NAN SILENCER

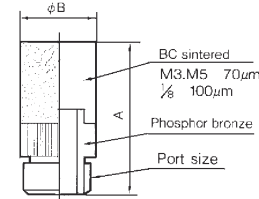

HOW TO ORDER SERIES NAN SILENCER

NAN120-M3 (M3)
NAN120-M5 (M5)
NAN110-N01 (1/8 NPT)
NAN101-N01 (1/8 NPT)

HOW TO ORDER SERIES AN SILENCER

AN120-M3 (M3)
AN120-M5 (M5)
AN110-01 (1/8 PT)
AN101-01 (1/8 PT)

Model	A	ØB
NAN101-N01	22.5	11
NAN110-N01	38	13
NAN120-M3	9	6
NAN120-M5	17	8

SERIES (N)AN SILENCER 1/4~2

- ✓ Over 30 dB noise reduction
- ✓ Low back pressure
- ✓ Compact and easy mounting

TECHNICAL SPECIFICATIONS

Max Operating Pressure	1MPa / 145PSI
Noise Reduction	30dB or more
Ambient & Fluid Temperature	5~60°C / 40~140°F

DIMENSIONS SERIES NAN SILENCER

AN200~400

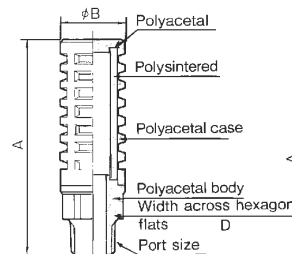

AN500~900

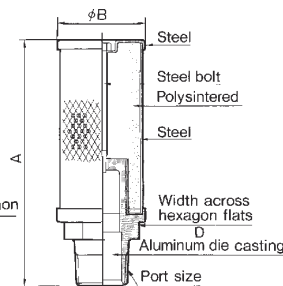

SYMBOLS

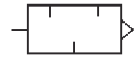

HOW TO ORDER SERIES NAN SILENCER

Model	Port Size* NPT	Effective Orifice mm ² (Cv)
NAN200-N02	1/4"	35 (1.9)
NAN300-N03	3/8"	60 (3.3)
NAN400-N04	1/2"	90 (5.0)
NAN500-N06	3/4"	160 (8.8)
NAN600-N10	1"	270 (15)
NAN700-N12	1 1/4"	440 (24)
NAN800-N14	1 1/2"	590 (33)
NAN900-N20	2"	960 (53)

Note: When ordering PT Ports, remove (N) from Model Number
Eg: AN200-02



Model	Dimensions (mm)		
	A	B	D
NAN200-N02	63	22	19
NAN300-N03	84	25	22
NAN400-N04	92	30	27
NAN500-N06	107	46	36
NAN600-N10	132	50	41
NAN700-N12	200	74	55
NAN800-N14	233	74	60
NAN900-N20	263	86	70



FOR FURTHER TECHNICAL DETAILS ON THIS PRODUCT, REQUEST CATALOG REFERENCE N510

X-ON Electronics

Largest Supplier of Electrical and Electronic Components

Click to view similar products for [Other Tools](#) category:

Click to view products by [SMC](#) manufacturer:

Other Similar products are found below :

[CR-05FL7--150R](#) [CR-05FL7--698K](#) [899-2-KT46](#) [899-5-KT46](#) [CR-0AFL4--332K](#) [CR-12FP4--260R](#) [CRCW04021961FRT7](#) [5800-0090](#)
[CRCW0603102JRT5](#) [59065-5](#) [00-8273-RDPP](#) [00-8729-WHPP](#) [593033](#) [593058](#) [593072](#) [593564100](#) [593575](#) [593591](#) [593593](#) [011349-000](#)
[LTI506SBLAMNBL](#) [LUC-012S070DSM](#) [LUC-018S070DSP](#) [599-2021-3-NME](#) [599-JJ-2021-03](#) [00-5080-YWPP](#) [5E4750/01-20R0-T/R](#)
[LW1A-L1-GL](#) [LW1A-P1-GD](#) [LW1L-A1C10V-GL](#) [LW1L-M1C70-A](#) [0202-0173](#) [00-9089-RDPP](#) [00-9300-RDPP](#) [01-1003W-8/32-10](#) [601-](#)
[GP-08-KT39](#) [601-JJ-06](#) [601-SPB](#) [601YSY](#) [602-JJ-03](#) [602SPB](#) [602Z](#) [603-JJ-07-FP](#) [603-JJY-04](#) [604J](#) [604-JJ-05](#) [CRTN1013](#) [CS16](#) [6-](#)
[1579014-0](#) [CSB2](#)