

MMIC VCO w/ BUFFER AMPLIFIER, 2.05 - 2.25 GHz



Typical Applications

Low noise MMIC VCO w/Buffer Amplifier for:

- Wireless Infrastructure
- Industrial Controls
- Test Equipment
- Military

Features

- Pout: +3.5 dBm
- Phase Noise: -112 dBc/Hz @100 KHz
- No External Resonator Needed
- Single Supply: 3V @ 35 mA
- QFN Leadless SMT Package, 16 mm²

Functional Diagram

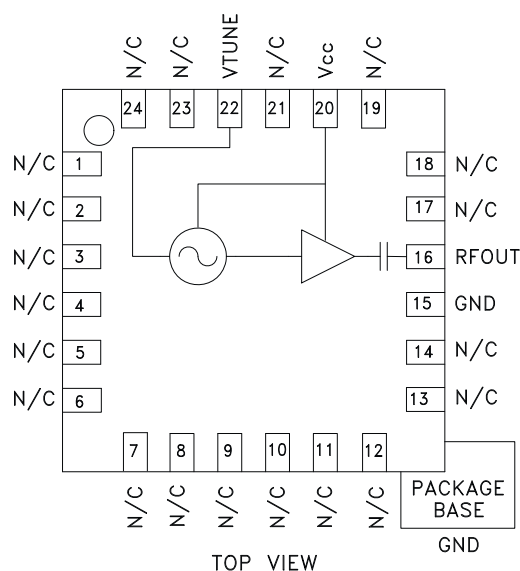

General Description

The HMC384LP4 & HM384LP4E are GaAs InGaP Heterojunction Bipolar Transistor (HBT) MMIC VCOs with integrated resonators, negative resistance devices, varactor diodes, and buffer amplifiers. The VCO's phase noise performance is excellent over temperature, shock, vibration and process due to the oscillator's monolithic structure. Power output is 3.5 dBm typical from a 3V supply voltage. The voltage controlled oscillator is packaged in a low cost leadless QFN 4 x 4 mm surface mount package.

Electrical Specifications, $T_A = +25^\circ C$, $V_{cc} = +3V$

Parameter	Min.	Typ.	Max.	Units
Frequency Range	2.05 - 2.25			GHz
Power Output	0.5	3.5		dBm
SSB Phase Noise @ 100 kHz Offset, $V_{tune} = +5V$ @ RF Output		-112		dBc/Hz
Tune Voltage (V_{tune})	0		10	V
Supply Current (I_{cc}) ($V_{cc} = +3.0V$)		35		mA
Tune Port Leakage Current			10	μA
Output Return Loss		6		dB
Harmonics				
2nd		-7		dBc
3rd		-23		dBc
Pulling (into a 2.0:1 VSWR)		2.5		MHz pp
Pushing @ $V_{tune} = +5V$		5		MHz/V
Frequency Drift Rate		0.25		MHz/ $^\circ C$

Information furnished by Analog Devices is believed to be accurate and reliable. However, no responsibility is assumed by Analog Devices for its use, nor for any infringements of patents or other rights of third parties that may result from its use. Specifications subject to change without notice. No license is granted by implication or otherwise under any patent or patent rights of Analog Devices. Trademarks and registered trademarks are the property of their respective owners.

For price, delivery, and to place orders: Analog Devices, Inc., One Technology Way, P.O. Box 9106, Norwood, MA 02062-9106 Phone: 781-329-4700 • Order online at www.analog.com Application Support: Phone: 1-800-ANALOG-D



HMC384LP4 / 384LP4E

MMIC VCO w/ BUFFER AMPLIFIER, 2.05 - 2.25 GHz

Frequency vs. Tuning Voltage, $T = 25^\circ\text{C}$

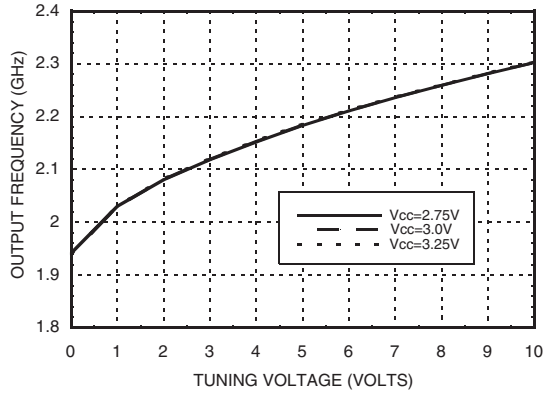

Frequency vs. Tuning Voltage, $V_{cc} = +3V$

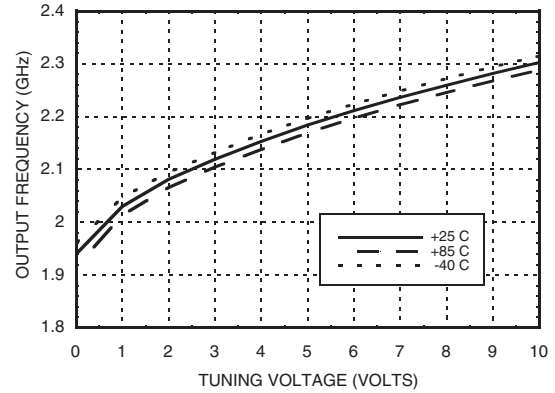

Sensitivity vs. Tuning Voltage, $V_{cc} = +3V$

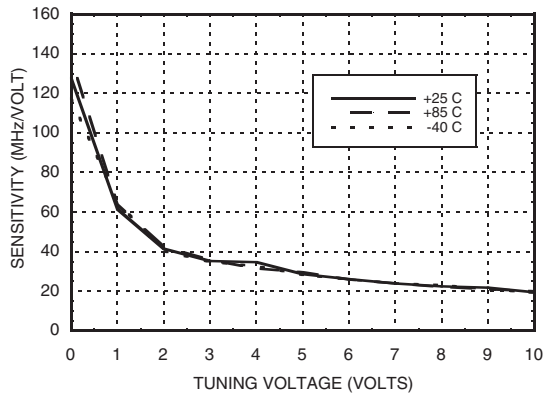

Output Power vs. Tuning Voltage, $V_{cc} = +3V$

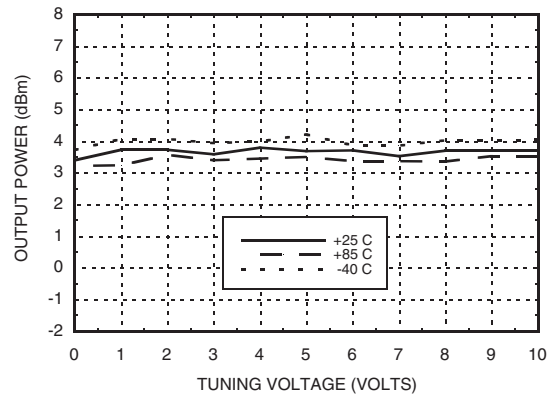

Phase Noise vs. Tuning Voltage

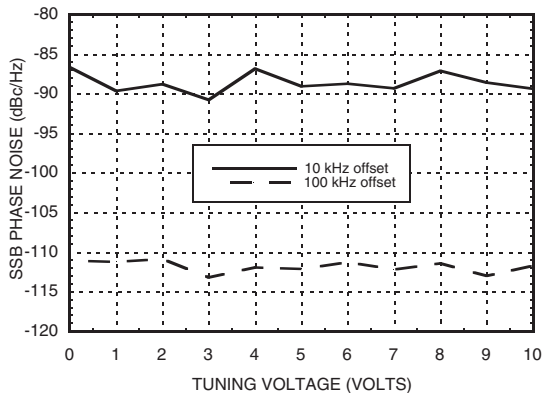

Typical SSB Phase Noise @ $V_{tune} = +5V$

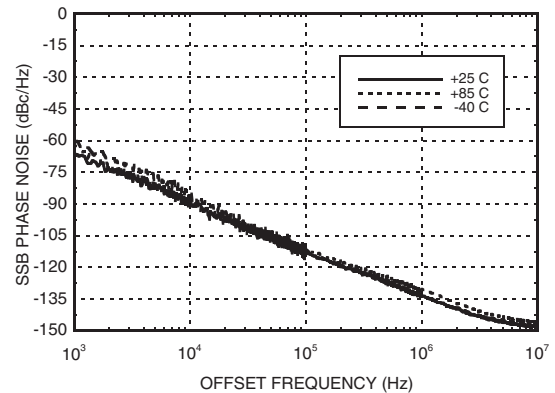

Information furnished by Analog Devices is believed to be accurate and reliable. However, no responsibility is assumed by Analog Devices for its use, nor for any infringements of patents or other rights of third parties that may result from its use. Specifications subject to change without notice. No license is granted by implication or otherwise under any patent or patent rights of Analog Devices. Trademarks and registered trademarks are the property of their respective owners.

For price, delivery, and to place orders: Analog Devices, Inc., One Technology Way, P.O. Box 9106, Norwood, MA 02062-9106 Phone: 781-329-4700 • Order online at www.analog.com Application Support: Phone: 1-800-ANALOG-D

MMIC VCO w/ BUFFER AMPLIFIER, 2.05 - 2.25 GHz



Absolute Maximum Ratings

Vcc	+3.5 Vdc
Vtune	0 to +11V
Channel Temperature	135 °C
Continuous P _{diss} (T = 85°C) (derate 6.28 mW/°C above 85°C)	565 W
Storage Temperature	-65 to +150 °C
Operating Temperature	-40 to +85 °C

Typical Supply Current vs. Vcc

Vcc (V)	Icc (mA)
2.75	28
3.0	35
3.25	41

Note: VCO will operate over full voltage range shown above.



ELECTROSTATIC SENSITIVE DEVICE
OBSERVE HANDLING PRECAUTIONS

Outline Drawing

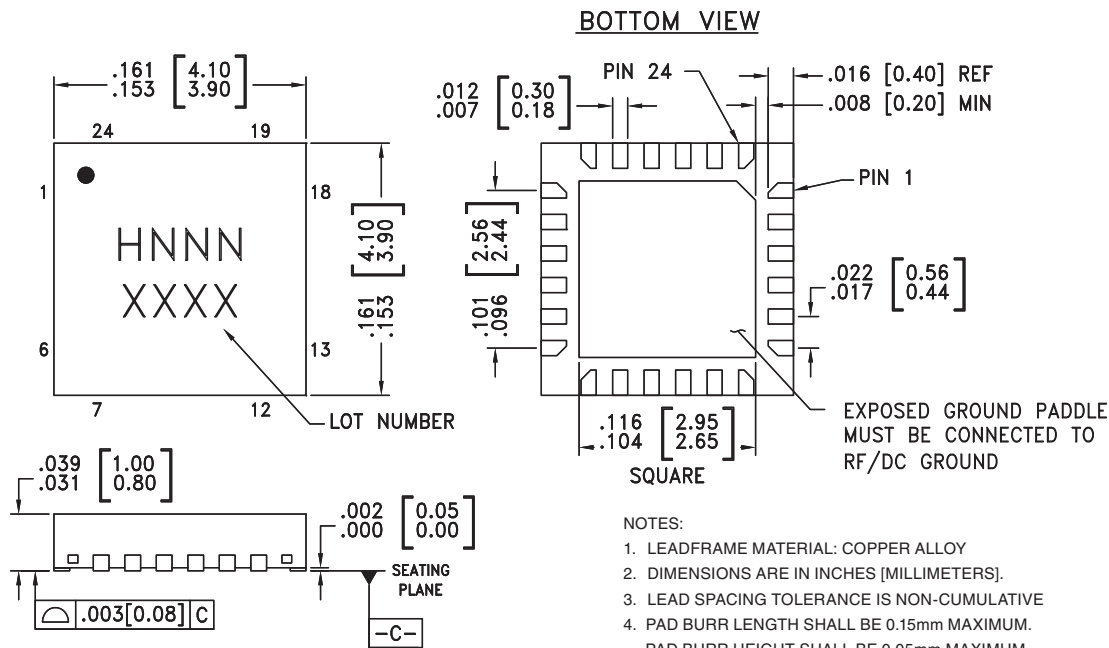

NOTES:

1. LEADFRAME MATERIAL: COPPER ALLOY
2. DIMENSIONS ARE IN INCHES [MILLIMETERS].
3. LEAD SPACING TOLERANCE IS NON-CUMULATIVE
4. PAD BURR LENGTH SHALL BE 0.15mm MAXIMUM.
PAD BURR HEIGHT SHALL BE 0.05mm MAXIMUM.
5. PACKAGE WARP SHALL NOT EXCEED 0.05mm.
6. ALL GROUND LEADS AND GROUND PADDLE MUST BE SOLDERED TO PCB RF GROUND.
7. REFER TO HITTITE APPLICATION NOTE FOR SUGGESTED PCB LAND PATTERN

Package Information

Part Number	Package Body Material	Lead Finish	MSL Rating	Package Marking ^[3]
HMC384LP4	Low Stress Injection Molded Plastic	Sn/Pb Solder	MSL1 ^[1]	H384 XXXX
HMC384LP4E	RoHS-compliant Low Stress Injection Molded Plastic	100% matte Sn	MSL1 ^[2]	H384 XXXX



[1] Max peak reflow temperature of 235 °C

[2] Max peak reflow temperature of 260 °C

[3] 4-Digit lot number XXXX

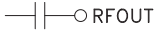
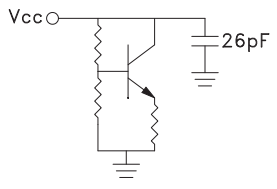
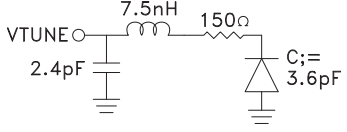

Pin Descriptions

Pin Number	Function	Description	Interface Schematic
1- 14, 17 - 19, 21, 23, 24	N/C	No Connection	
15	GND	This pin must be connected to RF & DC ground.	
16	RFOUT	RF output (AC coupled)	
20	Vcc	Supply Voltage Vcc= 3V	
22	VTUNE	Control Voltage Input. Modulation port bandwidth dependent on drive source impedance.	
	GND	Package bottom has an exposed metal paddle that must be RF & DC grounded.	

Information furnished by Analog Devices is believed to be accurate and reliable. However, no responsibility is assumed by Analog Devices for its use, nor for any infringements of patents or other rights of third parties that may result from its use. Specifications subject to change without notice. No license is granted by implication or otherwise under any patent or patent rights of Analog Devices. Trademarks and registered trademarks are the property of their respective owners.

For price, delivery, and to place orders: Analog Devices, Inc., One Technology Way, P.O. Box 9106, Norwood, MA 02062-9106 Phone: 781-329-4700 • Order online at www.analog.com Application Support: Phone: 1-800-ANALOG-D



**MMIC VCO w/ BUFFER
AMPLIFIER, 2.05 - 2.25 GHz**

Evaluation PCB

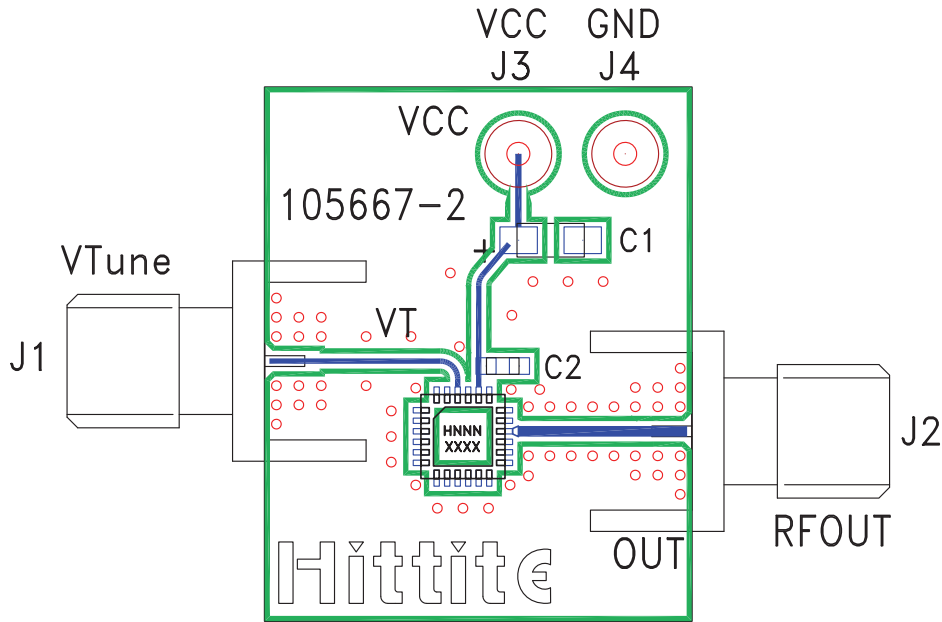

List of Materials for Evaluation PCB 105706 [1]

Item	Description
J1 - J2	PCB Mount SMA RF Connector
J3 - J4	DC Pin
C1	4.7 μ F Tantalum Capacitor
C2	10,000 pF Capacitor, 0603 Pkg.
U1	HMC384LP4 / HMC384LP4E VCO
PCB [2]	105667 Eval Board

[1] Reference this number when ordering complete evaluation PCB

[2] Circuit Board Material: Rogers 4350

The circuit board used in the final application should use RF circuit design techniques. Signal lines should have 50 ohm impedance while the package ground leads and exposed paddle should be connected directly to the ground plane similar to that shown. A sufficient number of via holes should be used to connect the top and bottom ground planes. The evaluation circuit board shown is available from Hittite upon request.



Notes:

v02.0705

HMC384LP4 / 384LP4E

**MMIC VCO w/ BUFFER
AMPLIFIER, 2.05 - 2.25 GHz**

X-ON Electronics

Largest Supplier of Electrical and Electronic Components

Click to view similar products for [Clock & Timer Development Tools](#) category:

Click to view products by [Analog Devices](#) manufacturer:

Other Similar products are found below :

[AD9517-0A/PCBZ](#) [AD9517-2A/PCBZ](#) [AD9522-4/PCBZ](#) [AD9520-5PCBZ](#) [AD9553/PCBZ](#) [ADCLK914PCBZ](#) [LMH2180SDEVAL](#) [DSC400-0333Q0032KE1-EVB](#) [TDGL013](#) [MAX2880EVKIT#](#) [MAX2750EVKIT](#) [MAX2752EVKIT](#) [ADCLK946PCBZ](#) [ADCLK946/PCBZ](#) [MAX2622EVKIT](#) [EKIT01-HMC1032LP6G](#) [Si5332-8IX-EVB](#) [RV-2251-C3-EVALUATION-BOARD](#) [Si5332-12IX-EVB](#) [RV-3029-C2-EVALUATION-BOARD-OPTION-B](#) [Si5332-6IX-EVB](#) [SKY72310-11-EVB](#) [EV1HMC8364LP6G](#) [RV-8263-C7-EVALUATION-BOARD](#) [EVK9FGV1002](#) [EVK9FGV1008](#) [EV1HMC6832ALP5L](#) [EVAL01-HMC830LP6GE](#) [EVAL01-HMC911LC4B](#) [TS3002DB](#) [125605-HMC702LP6CE](#) [LMX2487E-EVM](#) [MIKROE-2481](#) [2045](#) [EKIT01-HMC835LP6G](#) [EKIT01-HMC834LP6GE](#) [TS3006DB](#) [DSC-TIMEFLASH2-KIT1](#) [110227-HMC510LP5](#) [110227-HMC513LP5](#) [AD9515/PCBZ](#) [ADCLK948/PCBZ](#) [ADCLK954/PCBZ](#) [112261-HMC739LP4](#) [ADCLK925/PCBZ](#) [AD9522-0/PCBZ](#) [AD9520-4/PCBZ](#) [AC164147](#) [DFR0469](#) [LMK04133EVAL/NOPB](#)