



GaAs MMIC DOUBLE-BALANCED MIXER, 4 - 8 GHz

Typical Applications

The HMC129LC4 is ideal for:

- Microwave & VSAT Radios
- Test Equipment
- Military EW, ECM, C³I

Features

- Conversion Loss: 7 dB
- LO to RF and IF Isolation: 40 dB
- Input IP3: +17 dBm
- RoHS Compliant 4x4 mm SMT Package

Functional Diagram

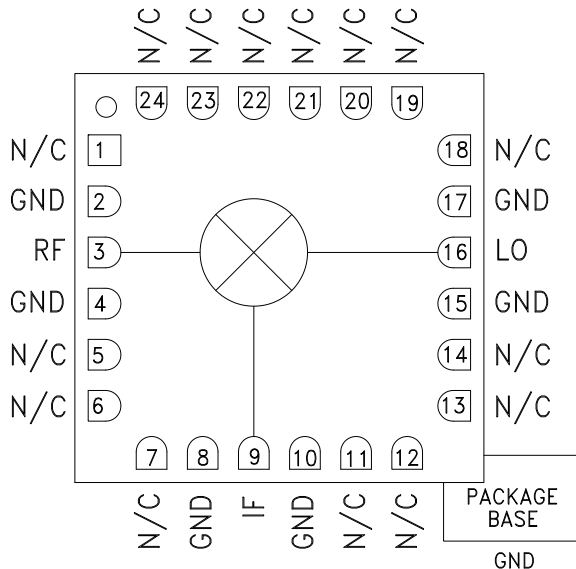

General Description

The HMC129LC4 is a general purpose double-balanced MMIC mixer housed in a leadless “PB Free” RoHS-Compliant SMT package which can be used as an upconverter or downconverter in the 4 to 8 GHz band. The HMC129LC4 is ideally suited for applications where small size, no DC bias, and consistent IC performance are required. This mixer can operate over a wide LO drive input of +9 to +15 dBm. It performs equally well as a Bi-Phase modulator or demodulator. The HMC129LC4 eliminates the need for wire bonding, allowing use of surface mount manufacturing techniques.

Electrical Specifications, $T_A = +25^\circ \text{C}$, LO Drive = +15 dBm*

Parameter	Min.	Typ.	Max.	Units
Frequency Range, RF & LO	4.0 - 8.0			GHz
Frequency Range, IF	DC - 3.0			GHz
Conversion Loss		7	9	dB
Noise Figure (SSB)		7	9	dB
LO to RF Isolation	30	40		dB
LO to IF Isolation	32	40		dB
IP3 (Input)		17		dBm
IP2 (Input)		50		dBm
1 dB Gain Compression (Input)		10		dBm

* Unless otherwise noted, all measurements performed as downconverter, IF = 100 MHz



**GaAs MMIC DOUBLE-BALANCED
MIXER, 4 - 8 GHz**

Conversion Gain vs. Temperature
LO = +15 dBm

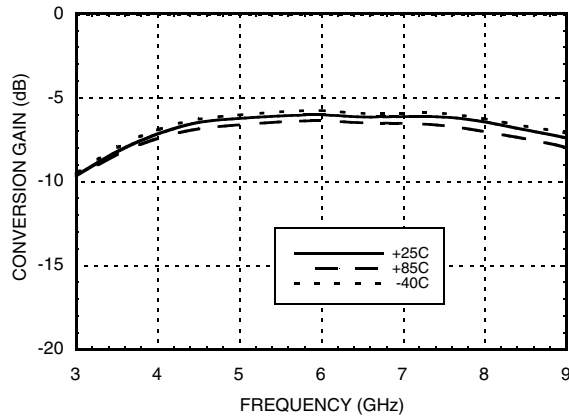

Isolation @ LO = +15 dBm

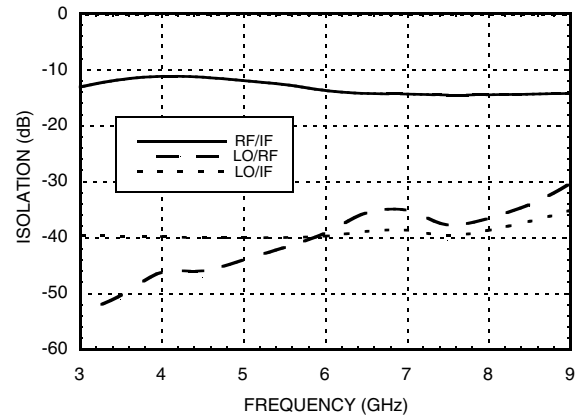

Conversion Gain vs. LO Drive

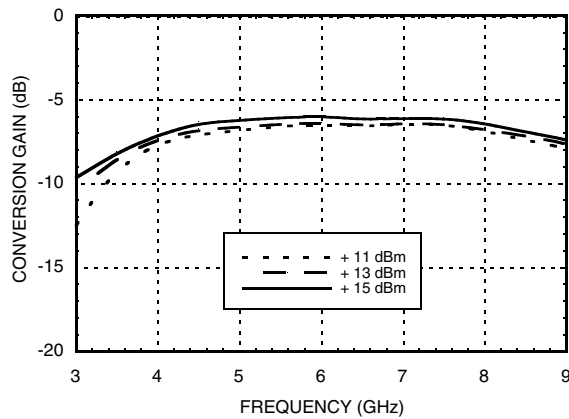

Return Loss @ LO = +15 dBm

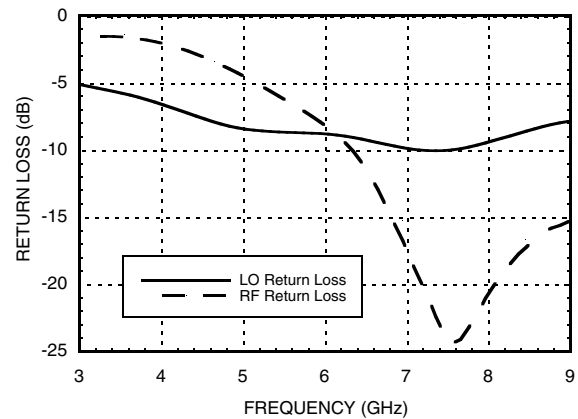

IF Bandwidth @ LO = +15 dBm

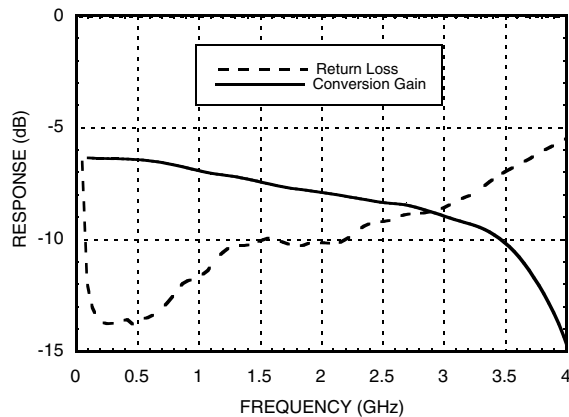

Upconverter Performance
Conversion Gain vs. LO Drive

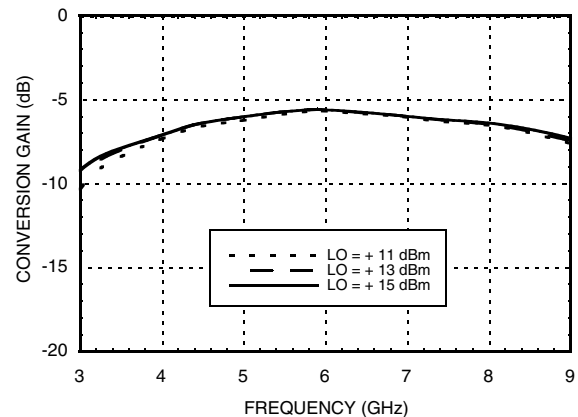



GaAs MMIC DOUBLE-BALANCED MIXER, 4 - 8 GHz

MIXERS - SINGLE & DOUBLE BALANCED - SMT

Input IP3 vs. LO Drive

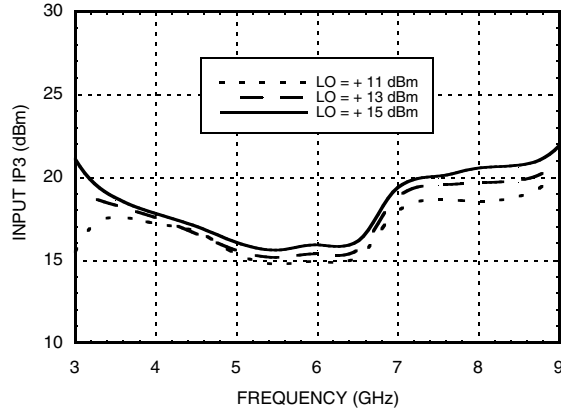

Input IP3 vs. Temperature @ LO = +15 dBm

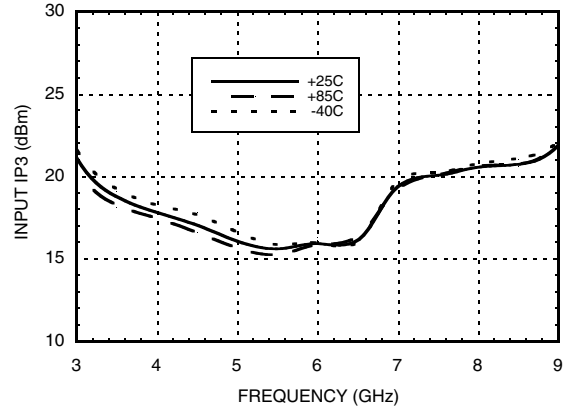

Input IP2 vs. LO Drive

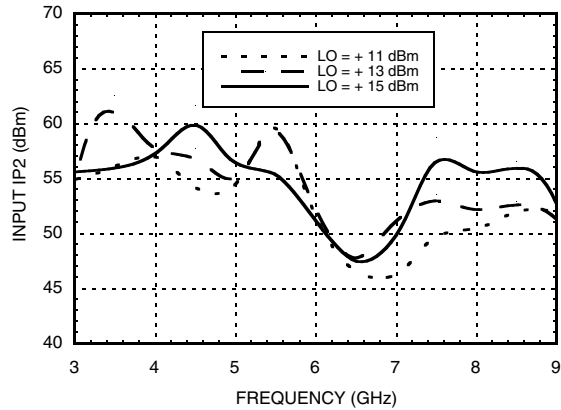

Input IP2 vs. Temperature @ LO = +15 dBm

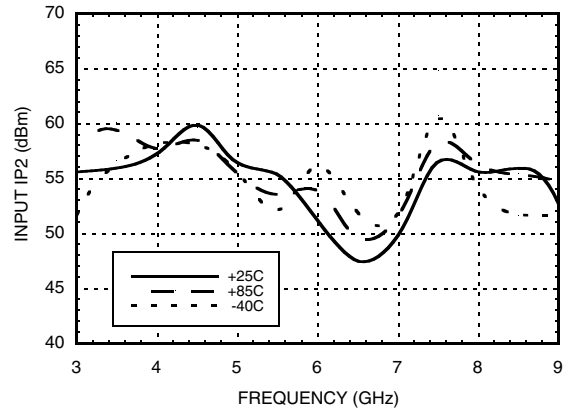

Input P1dB vs. Temperature @ LO = +15 dBm

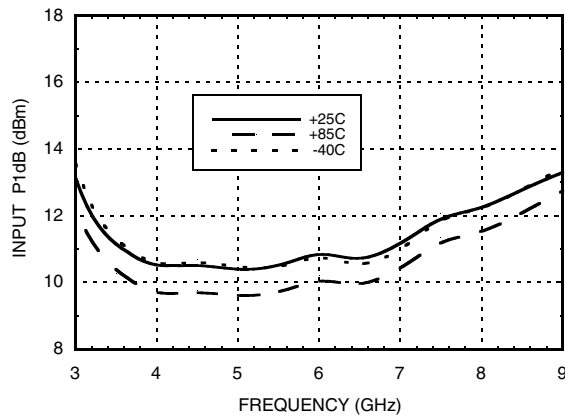

Harmonics of LO

LO Freq. (GHz)	nLO Spur @ RF Port			
	1	2	3	4
3	55	47	57	68
4	42	50	42	69
5	42	54	54	56
6	39	54	40	66
7	35	55	35	63
8	35	63	45	82
9	29	45	37	81
10	15	42	35	88

LO = +15 dBm
All values in dBc below input LO level measured at RF port

Information furnished by Analog Devices is believed to be accurate and reliable. However, no responsibility is assumed by Analog Devices for its use, nor for any infringements of patents or other rights of third parties that may result from its use. Specifications subject to change without notice. No license is granted by implication or otherwise under any patent or patent rights of Analog Devices. Trademarks and registered trademarks are the property of their respective owners.

For price, delivery, and to place orders: Analog Devices, Inc., One Technology Way, P.O. Box 9106, Norwood, MA 02062-9106 Phone: 781-329-4700 • Order online at www.analog.com Application Support: Phone: 1-800-ANALOG-D

**GaAs MMIC DOUBLE-BALANCED
MIXER, 4 - 8 GHz**
MxN Spurious @ IF Port

mRF	nLO				
	0	1	2	3	4
0	xx	10	25	13	41
1	9	0	33	44	46
2	78	76	70	78	86
3	88	91	87	64	81
4	97	102	104	109	110

RF Freq. = 6.1 GHz @ -10 dBm
LO Freq. = 6.0 GHz @ +15 dBm
Measured as downconverter

Absolute Maximum Ratings

RF/IF Input	+15 dBm
LO Drive	+27 dBm
IF DC Current	4 mA
Channel Temperature	150 °C
Continuous Pdiss (T = 85 °C) (derate 4.957 mW/ °C above 85 °C)	124 mW
Thermal Resistance (channel to ground paddle)	131.4 °C/W
Storage Temperature	-65 to +150 °C
Operating Temperature	-40 to +85 °C
ESD Sensitivity (HBM)	Class 1A

**ELECTROSTATIC SENSITIVE DEVICE
OBSERVE HANDLING PRECAUTIONS**



**GaAs MMIC DOUBLE-BALANCED
MIXER, 4 - 8 GHz**

Outline Drawing

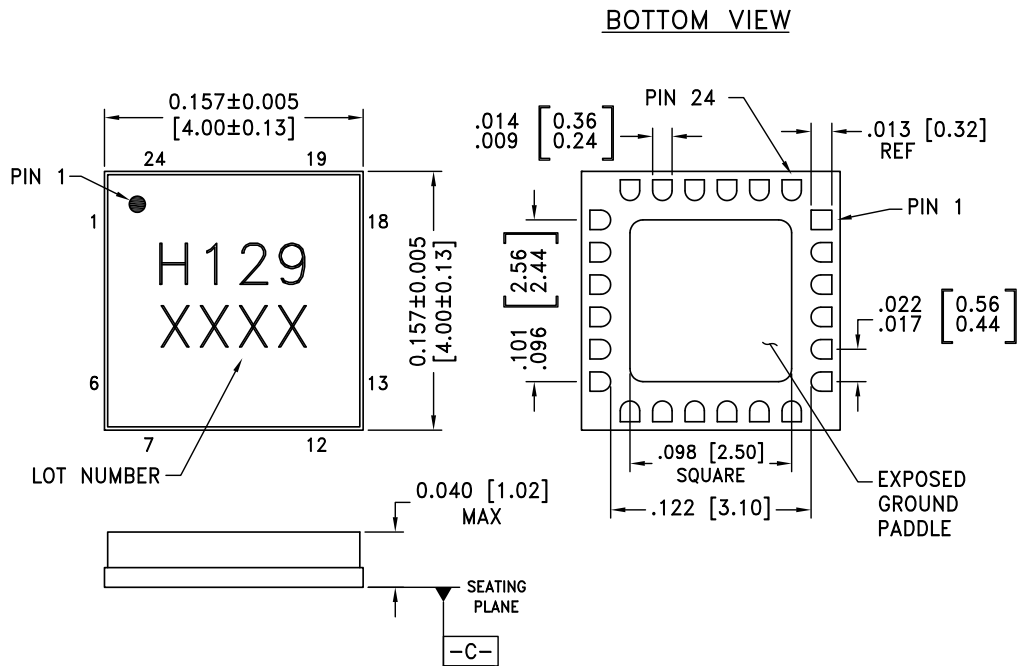

NOTES:

1. PACKAGE BODY MATERIAL: ALUMINA
2. LEAD AND GROUND PADDLE PLATING: GOLD FLASH OVER Ni
3. DIMENSIONS ARE IN INCHES [MILLIMETERS]
4. LEAD SPACING TOLERANCE IS NON-CUMULATIVE
5. PACKAGE WARP SHALL NOT EXCEED 0.05mm DATUM -C-
6. ALL GROUND LEADS AND GROUND PADDLE MUST BE SOLDERED TO PCB RF GROUND

Package Information

Part Number	Package Body Material	Lead Finish	MSL Rating	Package Marking ^[2]
HMC129LC4	Alumina, White	Gold over Nickel	MSL3 ^[1]	H129 XXXX

[1] Max peak reflow temperature of 260 °C

[2] 4-Digit lot number XXXX



GaAs MMIC DOUBLE-BALANCED MIXER, 4 - 8 GHz

Pin Descriptions

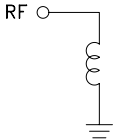
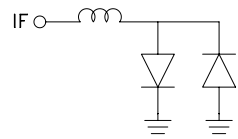
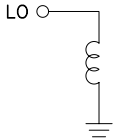
Pin Number	Function	Description	Interface Schematic
1, 5 - 7, 11 - 14, 18 - 24	N/C	No Connection. These pins may be connected to RF/DC ground. Performance will not be affected.	
2, 4, 8, 10, 15, 17	GND	These pins and package bottom must be connect to RF/DC ground.	
3	RF	This pin is DC coupled and matched to 50 Ohms.	
9	IF	This pin is DC coupled. For applications not requiring operation to DC, this port should be DC blocked externally using a series capacitor whose value has been chosen to pass the necessary IF frequency range. For operation to DC, this pin must not source/sink more than 2 mA of current or die non-function and possible die failure will result.	
16	LO	This pin is DC coupled and matched to 50 Ohms.	



**GaAs MMIC DOUBLE-BALANCED
MIXER, 4 - 8 GHz**

Evaluation PCB

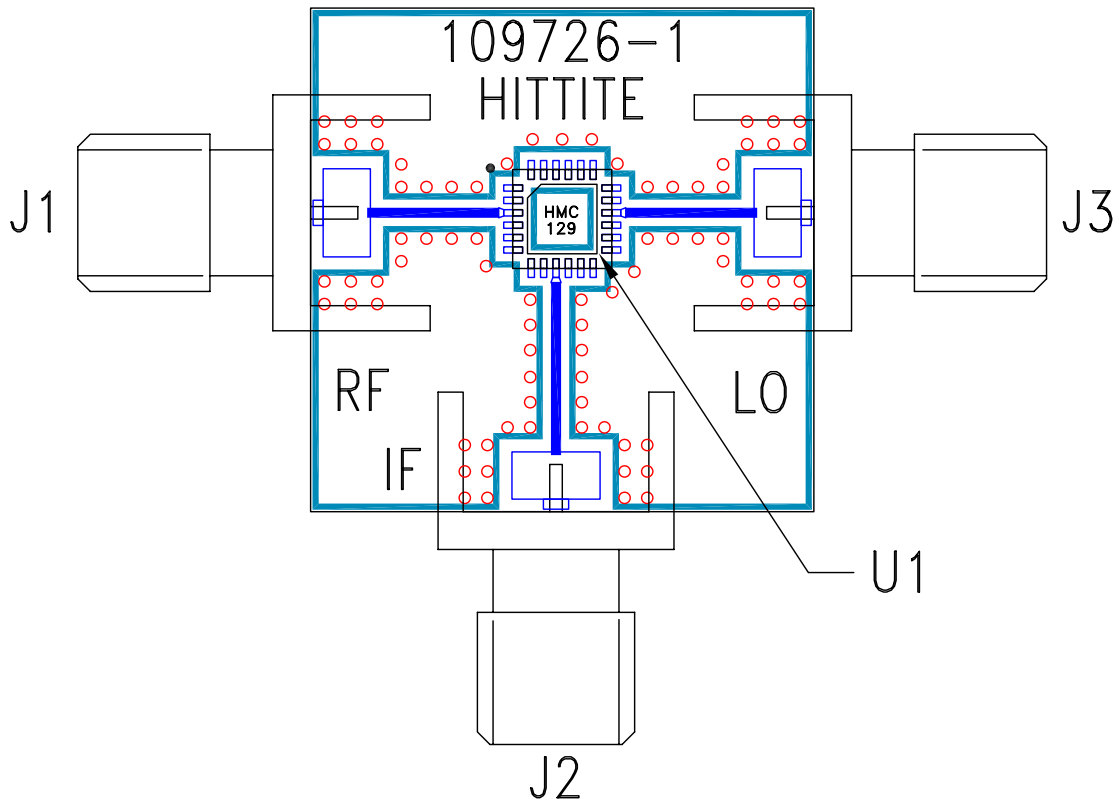

List of Materials for Evaluation PCB 109728 [1]

Item	Description
J1 - J3	PCB Mount SMA Connector
U1	HMC129LC4
PCB [2]	109726 Evaluation Board

[1] Reference this number when ordering complete evaluation PCB

[2] Circuit Board Material: Rogers 4350

The circuit board used in the application should use RF circuit design techniques. Signal lines should have 50 Ohm impedance while the package ground leads and exposed paddle should be connected directly to the ground plane similar to that shown. A sufficient number of via holes should be used to connect the top and bottom ground planes. The evaluation circuit board shown is available from Hit-tite upon request.

**GaAs MMIC DOUBLE-BALANCED
MIXER, 4 - 8 GHz**

X-ON Electronics

Largest Supplier of Electrical and Electronic Components

Click to view similar products for [RF Mixer](#) category:

Click to view products by [Analog Devices](#) manufacturer:

Other Similar products are found below :

[HMC337-SX](#) [HMC404-SX](#) [mamx-009646-23dbml](#) [HMC339-SX](#) [HMC8192-SX](#) [MIQ24MS-2](#) [HMC220BMS8GETR](#) [M85C](#) [HMC554A-SX](#)
[HMC8192LG](#) [HMC521A-SX](#) [HMC521ACHIPS](#) [CMD258C4](#) [LT5511EFE](#) [MAMX-011023-SMB](#) [HMC399MS8TR](#) [HMC333TR](#)
[HMC214MS8TR](#) [HMC175MS8TR](#) [MAMXSS0012TR-3000](#) [109728-HMC129LC4](#) [CSM1-13](#) [SA612AD/01.112](#) [HMC785LP4ETR](#)
[LT5579IUH#PBF](#) [HMC773ALC3BTR](#) [HMC558ALC3B](#) [HMC329ALC3B](#) [MY63H](#) [AD8343ARUZ-REEL7](#) [AD608AR](#) [AD608ARZ](#)
[AD831APZ](#) [AD831APZ-REEL7](#) [AD8342ACPZ-REEL7](#) [AD8343ARUZ](#) [AD8344ACPZ-REEL7](#) [ADL5350ACPZ-R7](#) [ADL5363ACPZ-R7](#)
[ADL5365ACPZ-R7](#) [ADL5801ACPZ-R7](#) [ADL5802ACPZ-R7](#) [HMC1056LP4BE](#) [HMC1057-SX](#) [HMC1063LP3E](#) [HMC1093-SX](#) [HMC1106-](#)
[SX](#) [HMC129](#) [HMC143](#) [HMC400MS8ETR](#)