



# HMC548LP3 / 548LP3E

## SiGe HBT MMIC LOW NOISE AMPLIFIER, 1.2 - 3.0 GHz

### Typical Applications

The HMC548LP3 / HMC548LP3E is ideal for:

- Automotive Telematics
- GPS Antenna Modules / Boosters
- Location Based Portables
- Satellite Navigation

### Features

- Single Supply: Vcc = +3 to +5V
- Low Noise Figure: 1.3 dB
- High Output IP3: +21 dBm
- No External Matching Required
- External Filter Access
- 3x3 mm Leadless SMT Package

### Functional Diagram

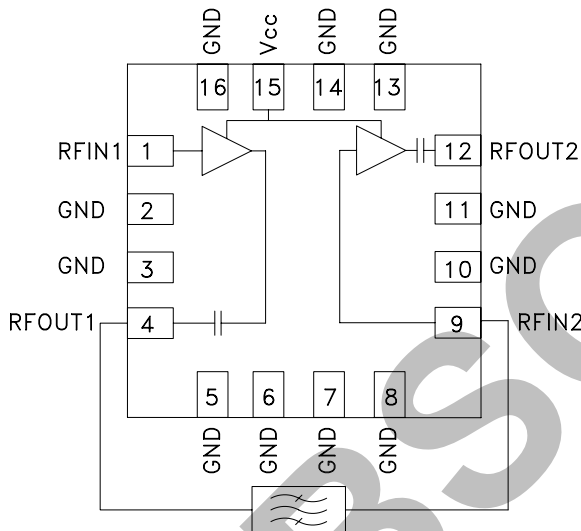

### General Description

The HMC548LP3 & HMC548LP3E are comprised of two internally matched SiGe HBT MMIC low noise amplifier stages housed in 3x3 mm leadless SMT packages. The unique topology of the HMC548LP3 & HMC548LP3E provides interstage access allowing the designer to place a bandpass filter between the two amplifier stages. This filtering approach enables the receiver to reject nearby blocking signals such as those emitted from cellular and 3G hand-helds, without incurring the noise figure degradation associated with a high rejection pre-filter. When combined with the appropriate interstage bandpass filter, this LNA can be used as a receiver pre-amplifier in various applications from 1.2 to 3 GHz. Evaluation boards are available with or without a GPS L1 (1575 MHz) band pass filter.

### Electrical Specifications, $T_A = +25^\circ\text{C}^*$

Parameter	Min.	Typ.	Max.	Min.	Typ.	Max.	Units
Frequency Range	1575						MHz
Vcc	+3			+5			V
Gain	20	23		23	26		dB
Gain Variation Over Temperature		0.04	0.05		0.04	0.05	dB/°C
Noise Figure		1.6	1.9		1.3	1.6	dB
Input Return Loss		8			8		dB
Output Return Loss		14			16		dB
Output 1 dB Compression (P1dB)		8			11		dBm
Saturated Output Power (Psat)		10.5			12		dBm
Output Third Order Intercept (IP3)		13			21		dBm
Supply Current (Icc)		10	15		21	30	mA

\* All measurements include external 1.57 - 1.6 GHz (GPS L1) band pass filter connected between pin 4 & pin 9.



**Gain & Return Loss [1]**

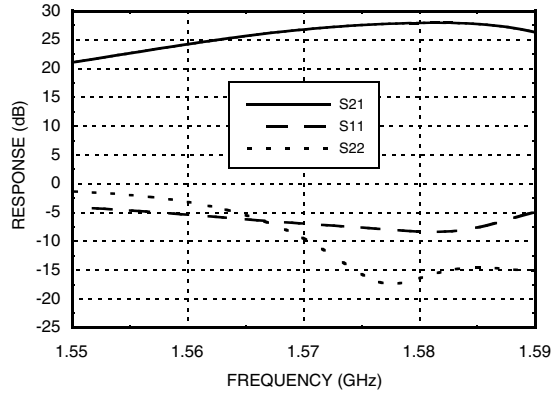

**Gain vs. Temperature [1]**

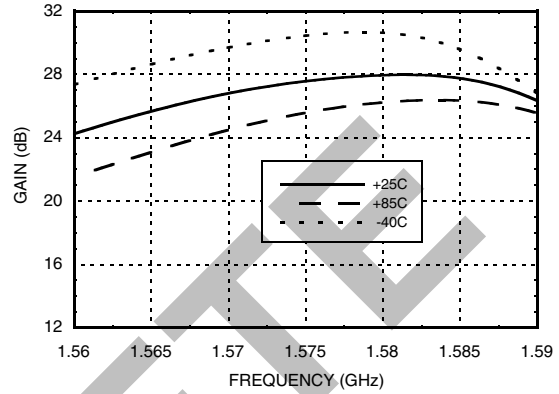

**Input Return Loss vs. Temperature [1]**

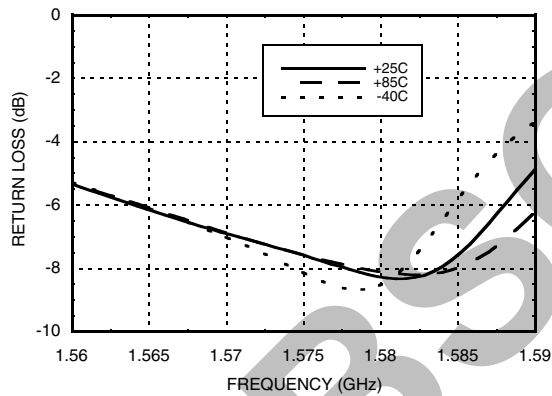

**Output Return Loss vs. Temperature [1]**

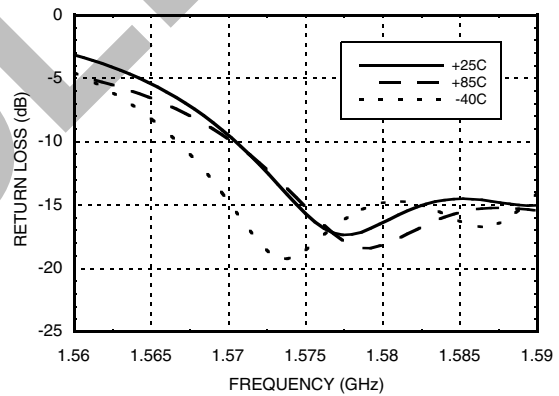

**Reverse Isolation vs. Temperature [1]**

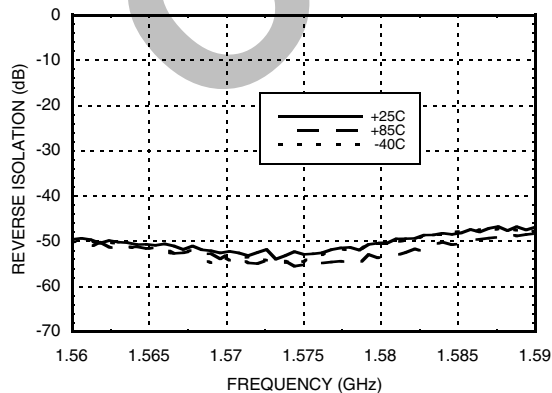

**Noise Figure vs. Temperature [1]**

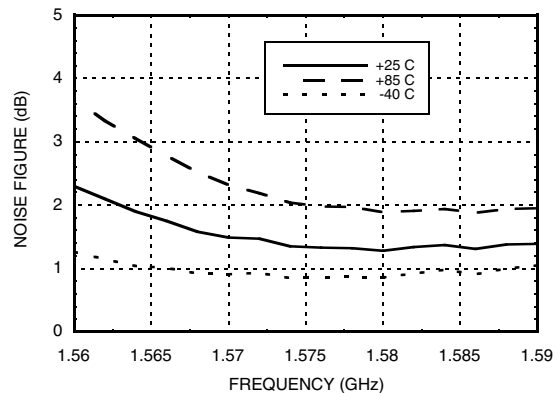

[1] Measurement includes external 1.57 - 1.6 GHz (GPS L1) band pass filter connected between pin 4 and pin 9. Vcc = +5V.

**P1dB vs. Temperature [1]**

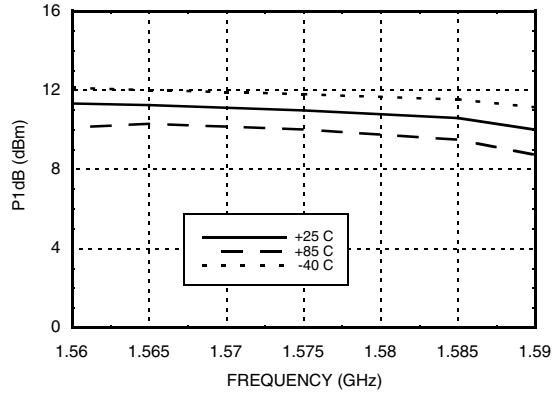

**Psat vs. Temperature [1]**

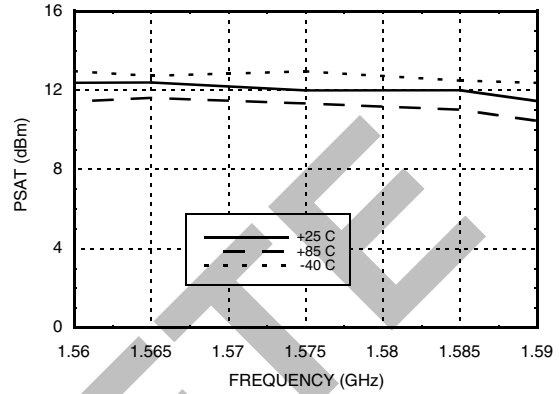

**Output IP3 vs. Temperature [1]**

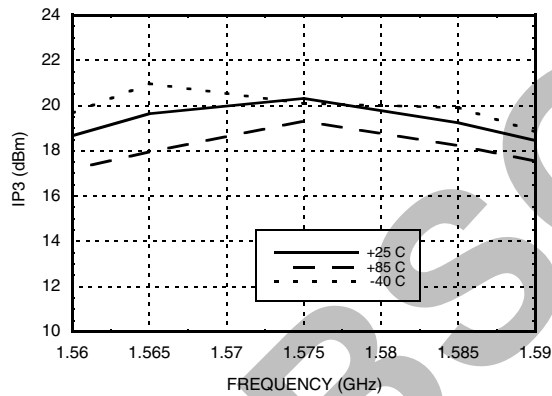

**Broadband Gain & Return Loss [2]**

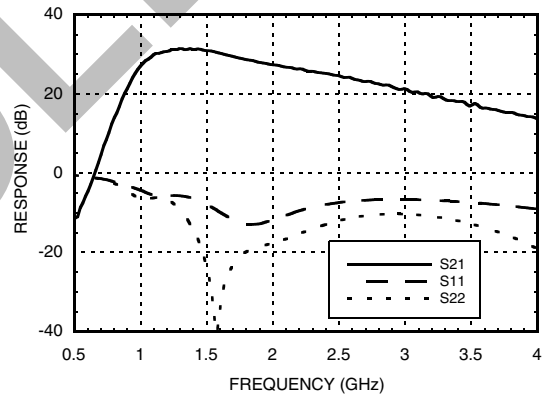

**Gain vs. Temperature [2]**

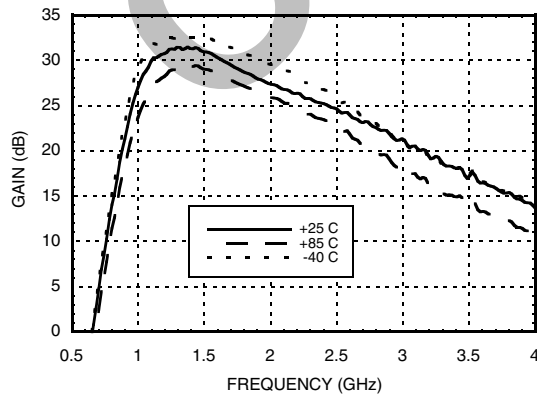

**Input Return Loss vs. Temperature [2]**

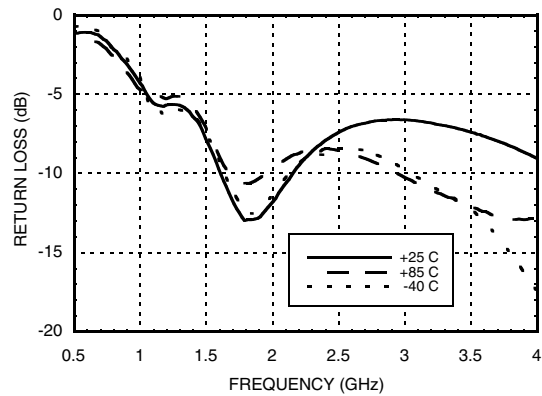

[1] Measurement includes external 1.57 - 1.6 GHz (GPS L1) band pass filter connected between pin 4 and pin 9. Vcc = +5V.

[2] Measurement includes external 50 Ohm line between pin 4 and pin 9. Vcc = +5V.



**Output Return Loss vs. Temperature [2]**

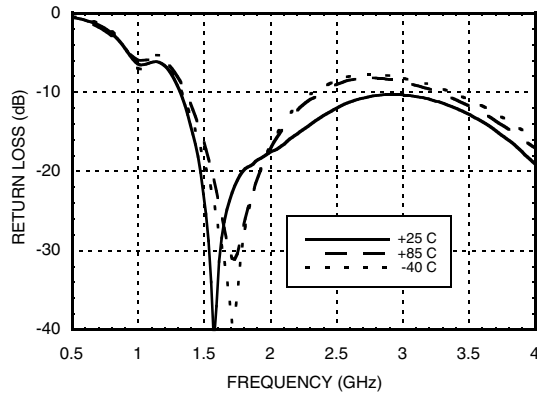

**Reverse Isolation vs. Temperature [2]**

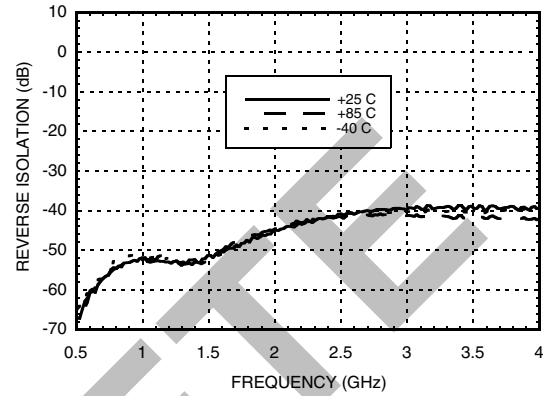

**Noise Figure vs. Temperature [2]**

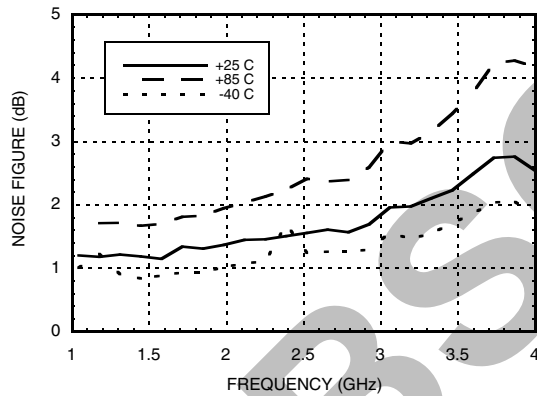

**P1dB vs. Temperature [2]**

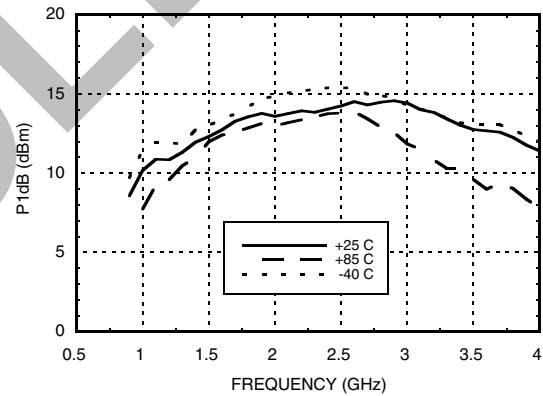

**Psat vs. Temperature [2]**

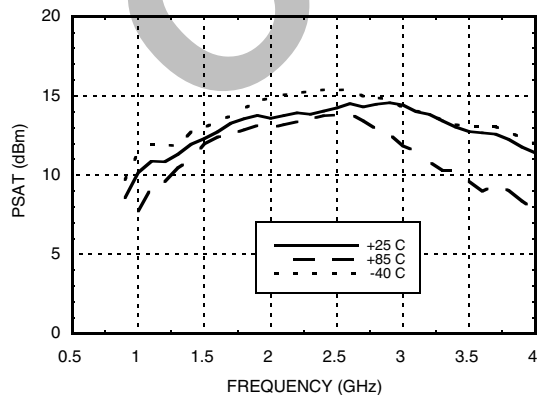

**Output IP3 vs. Temperature [2]**

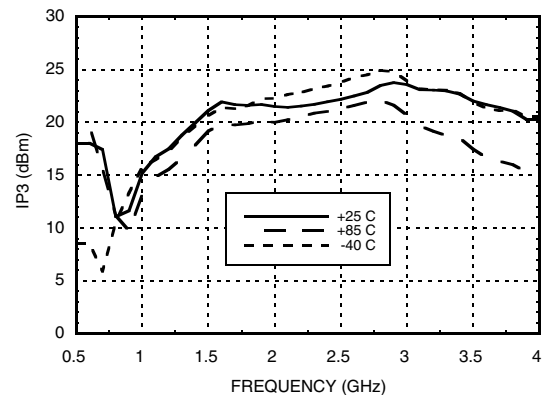

[2] Measurement includes external 50 Ohm line between pin 4 and pin 9. Vcc = +5V.

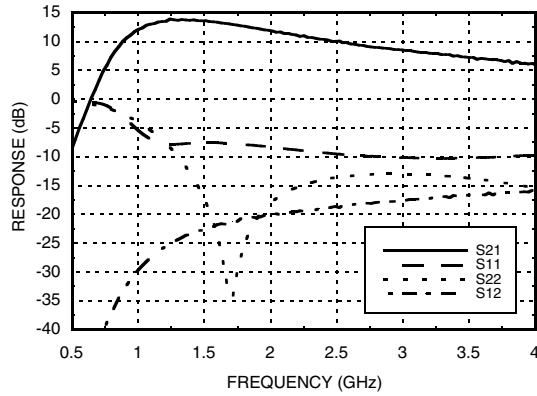
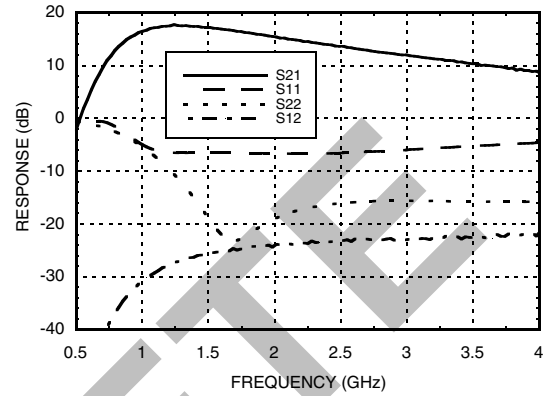
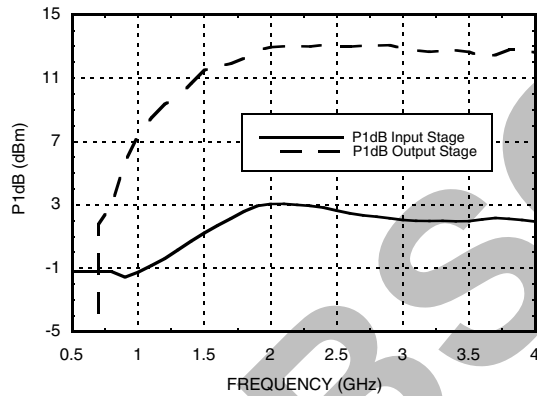
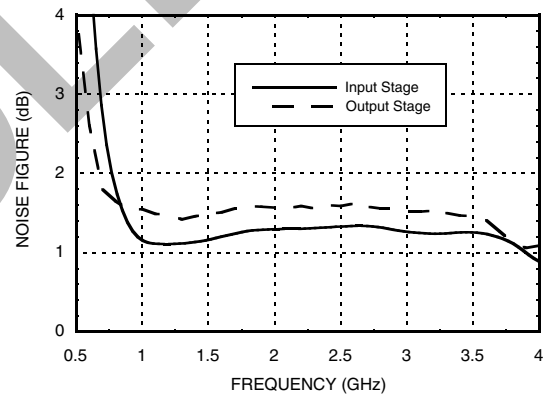
**Small Signal Parameters Input Stage [3]**

**Small Signal Parameters Output Stage [3]**

**P1dB Individual Stages [3]**

**Noise Figure Individual Stages [3]**

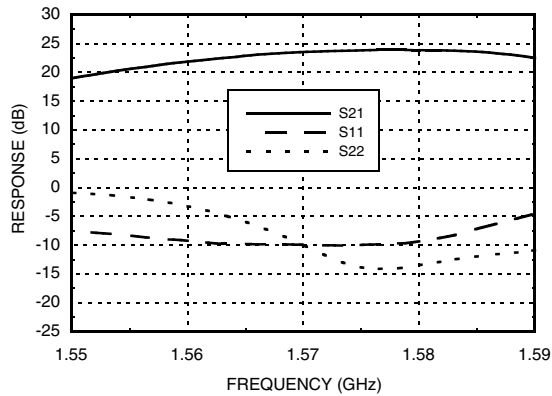
[3] Vcc = +5V.



**Gain & Return Loss [4]**



**Gain vs. Temperature [4]**

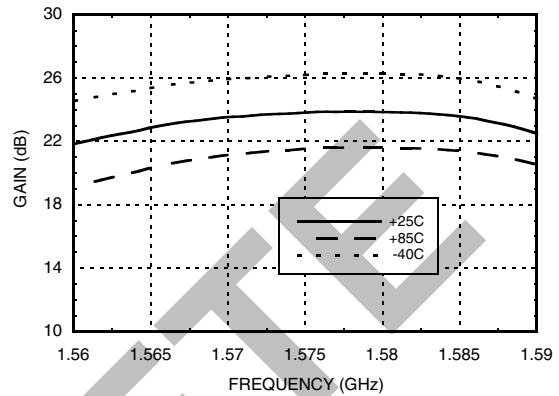

**Input Return Loss vs. Temperature [4]**

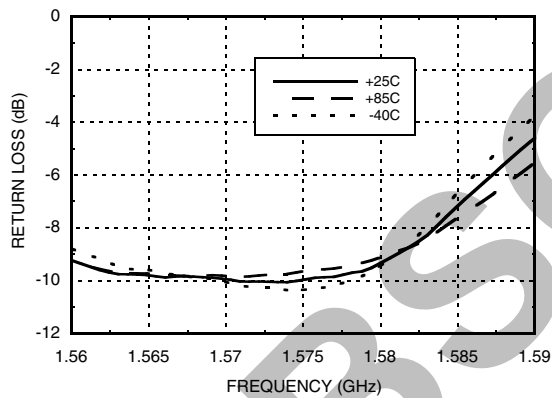

**Output Return Loss vs. Temperature [4]**

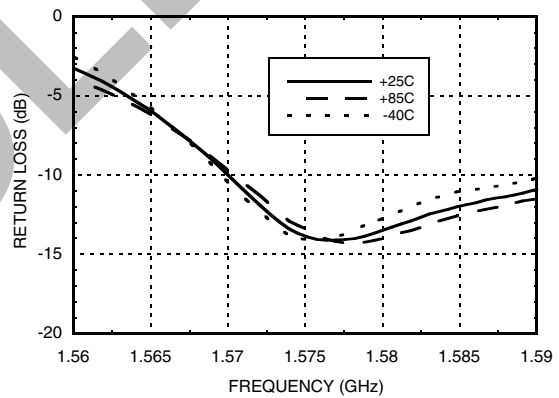

**Reverse Isolation vs. Temperature [4]**

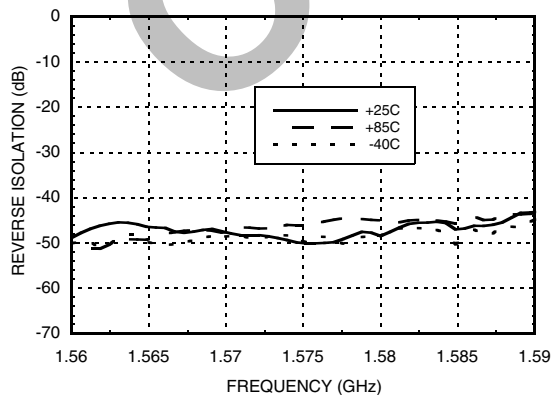

**Noise Figure vs. Temperature [4]**

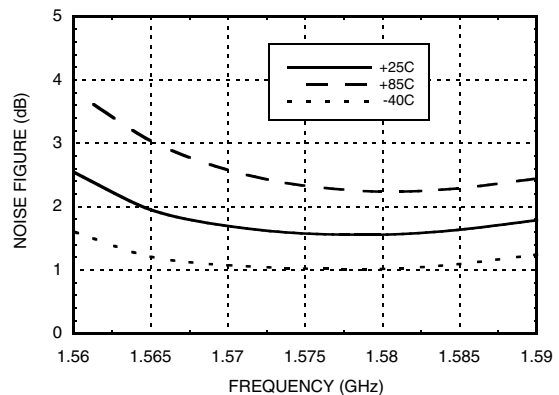

[4] Measurement includes external 1.57 - 1.6 GHz (GPS L1) band pass filter connected between pin 4 and pin 9. Vcc = +3V.

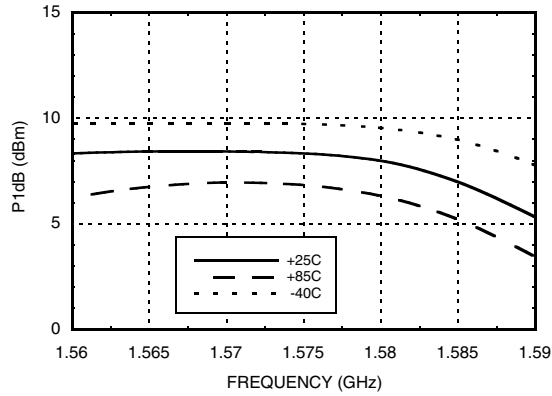
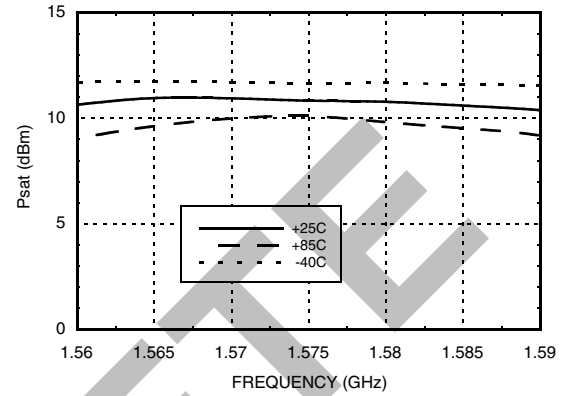
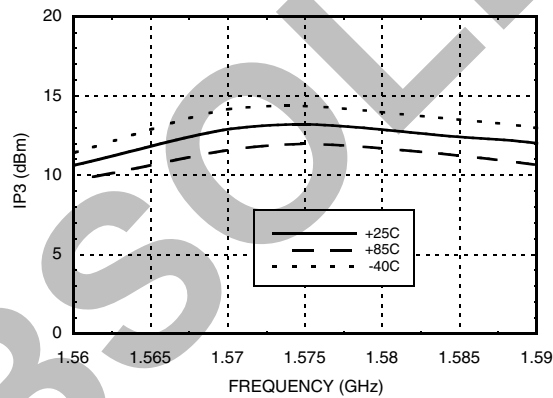
**P1dB vs. Temperature [4]**

**Psat vs. Temperature [4]**

**Output IP3 vs. Temperature [4]**

**Absolute Maximum Ratings**

Drain Bias Voltage (Vcc)	+7.0 Vdc
RF Input Power (RFIN)	-5 dBm
Junction Temperature	150 °C
Continuous Pdiss (T = 85 °C) (derate 14 mW/°C above 85 °C)	0.942 W
Thermal Resistance (junction to ground paddle)	69 °C/W
Storage Temperature	-65 to +150 °C
Operating Temperature	-40 to +85 °C
ESD Sensitivity (HBM)	Class 1B

**Typical Supply Current vs. Vcc**

Vcc (Vdc)	Icc (mA)
3.0	10
4.5	17
5.0	21
5.5	24

**ELECTROSTATIC SENSITIVE DEVICE  
OBSERVE HANDLING PRECAUTIONS**

[4] Measurement includes external 1.57 - 1.6 GHz (GPS L1) band pass filter connected between pin 4 and pin 9. Vcc = +3V.

### Outline Drawing

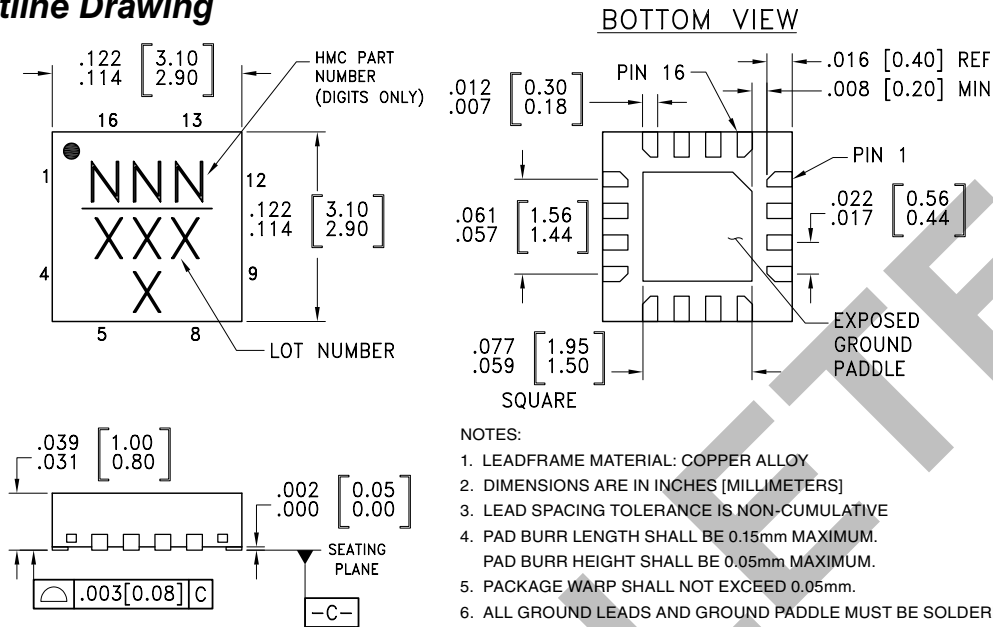

### Package Information

Part Number	Package Body Material	Lead Finish	MSL Rating	Package Marking <sup>[3]</sup>
HMC548LP3	Low Stress Injection Molded Plastic	Sn/Pb Solder	MSL1 <sup>[1]</sup>	548 XXXX
HMC548LP3E	RoHS-compliant Low Stress Injection Molded Plastic	100% matte Sn	MSL1 <sup>[2]</sup>	548 XXXX

[1] Max peak reflow temperature of 235 °C  
 [2] Max peak reflow temperature of 260 °C  
 [3] 4-Digit lot number XXXX

### Pin Descriptions

Pin Number	Function	Description	Interface Schematic
1	RFIN1	This pin is DC coupled and matched to 50 Ohms from 1.2 to 2.0 GHz. An off chip blocking capacitor is required.	
2, 3, 5 - 8, 10, 11, 13, 14, 16	GND	These pins and package ground paddle must be connected to RF/DC ground.	
4	RFOUT1	This pin is AC coupled and matched to 50 Ohms from 1.2 - 2 GHz.	
9	RFIN2	This pin is DC coupled and matched to 50 Ohms from 1.2 to 2.0 GHz. An off chip blocking capacitor is required.	
12	RFOUT2	This pin is AC coupled and matched to 50 Ohms from 1.2 - 2 GHz.	
15	Vcc	Power supply voltage for the amplifier. External bypass capacitors of 1,000pF and 18,000 pF are required.	



### Application Circuit

Component	Value
C1, C2	150 pF
C3	1,000 pF
C4	18,000 pF

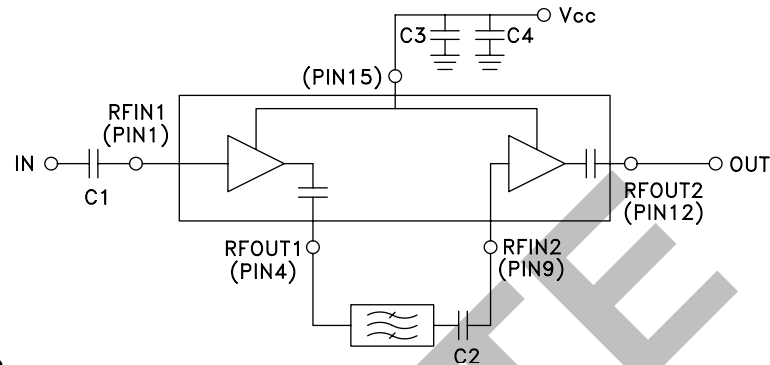

### 1575 MHz Evaluation PCB

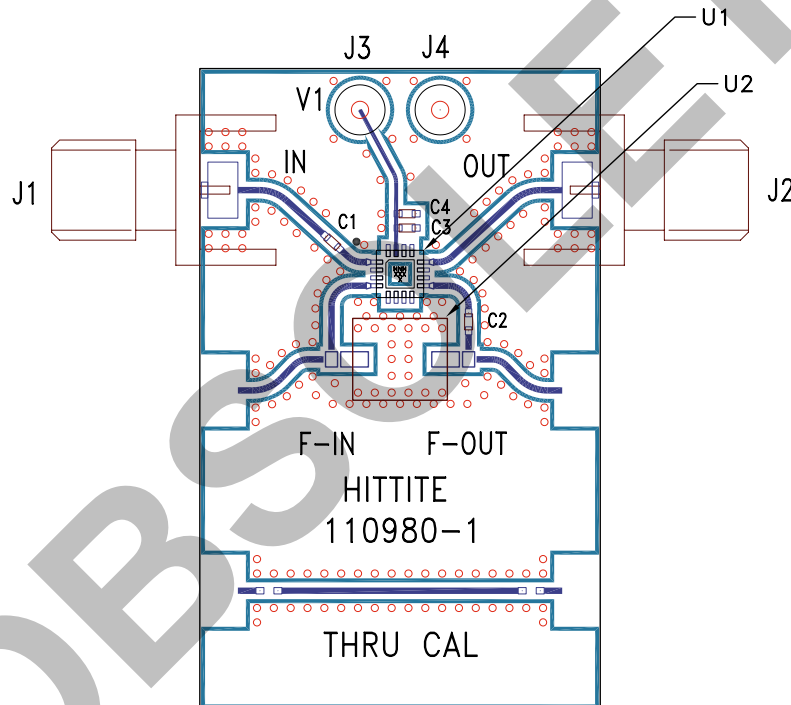

### List of Material for Evaluation PCB 114254<sup>[1]</sup>

Item	Description
J1, J2	PCB Mount SMA Connector
J3, J4	DC Pin
C1, C2	150 pF Capacitor, 0402 Pkg.
C3	1000 pF Capacitor, 0402 Pkg.
C4	18,000 pF Capacitor, 0402 Pkg.
U1	HMC548LP3 / HMC548LP3E Amplifier
U2	Filter, Amotech AMOBP1575P02-A1 2.5 dB loss @ 1575 MHz
PCB [2]	110980 Evaluation PCB

[1] Reference this number when ordering complete evaluation PCB

[2] Circuit Board Material: Rogers 4350

The circuit board used in the application should use RF circuit design techniques. Signal lines should have 50 Ohm impedance while the package ground leads and exposed ground paddle should be connected directly to the ground plane similar to that shown above. A sufficient number of via holes should be used to connect the top and bottom ground planes. The evaluation circuit board shown is available from Hittite upon request.

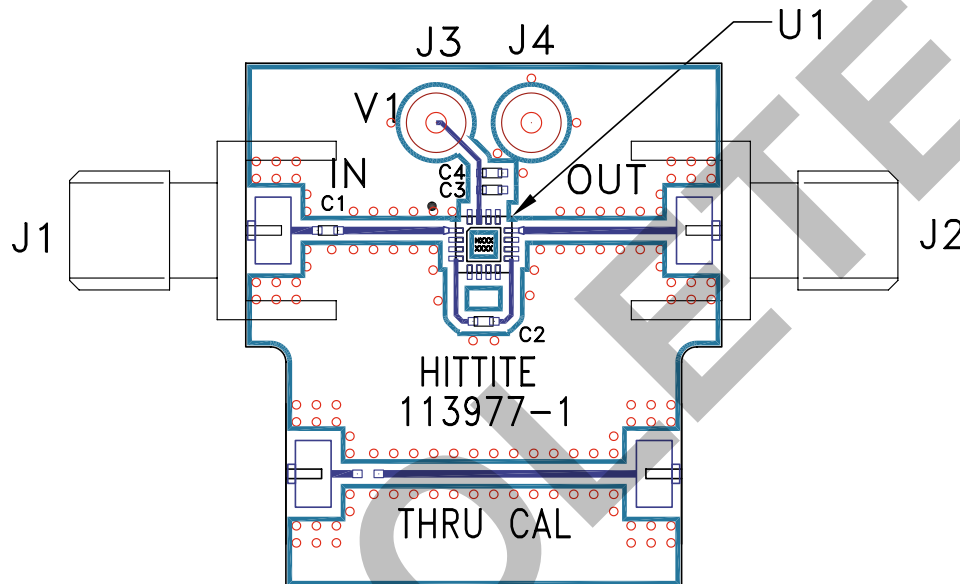
**Wideband (No Filter) Evaluation PCB**

**List of Material for Evaluation PCB 113979 [1]**

Item	Description
J1, J2	PCB Mount SMA Connector
J3, J4	DC Pin
C1, C2	150 pF Capacitor, 0402 Pkg.
C3	1000 pF Capacitor, 0402 Pkg.
C4	18,000 pF Capacitor, 0402 Pkg.
U1	HMC548LP3 / HMC548LP3E Amplifier
PCB [2]	113977 Evaluation PCB

[1] Reference this number when ordering complete evaluation PCB

[2] Circuit Board Material: Rogers 4350

The circuit board used in the application should use RF circuit design techniques. Signal lines should have 50 Ohm impedance while the package ground leads and exposed ground paddle should be connected directly to the ground plane similar to that shown above. A sufficient number of via holes should be used to connect the top and bottom ground planes. The evaluation circuit board shown is available from Hittite upon request.

## X-ON Electronics

Largest Supplier of Electrical and Electronic Components

*Click to view similar products for [Mobile Development Tools](#) category:*

*Click to view products by [Analog Devices](#) manufacturer:*

Other Similar products are found below :

[MIKROE-2535](#) [1946](#) [ADRV-DPD1/PCBZ](#) [TEL0089](#) [EVK-N211-02B](#) [1963](#) [2687](#) [2691](#) [MAX7036EVKIT-315+](#) [MAX7036EVKIT-433+](#)  
[MIKROE-3350](#) [MIKROE-3351](#) [MIKROE-3757](#) [MIKROE-3885](#) [MIKROE-4034](#) [MIKROE-1298](#) [MIKROE-1375](#) [MIKROE-1428](#) [MIKROE-1720](#) [MIKROE-3072](#) [MIKROE-3294](#) [MIKROE-497](#) [VZ120Q-STK](#) [109030001](#) [109030002](#) [CEL-13120](#) [CEL-14997](#) [EVK-R510M8S-0](#)  
[EVK-R510S-0](#)