

GaAs SMT PHEMT LOW NOISE AMPLIFIER, 0.55 - 1.2 GHz



Typical Applications

The HMC617LP3(E) is ideal for:

- Cellular/3G and LTE/WiMAX/4G
- BTS & Infrastructure
- Repeaters and Femtocells
- Public Safety Radio
- Access Points

Features

- Noise Figure: 0.5 dB
- Gain: 16 dB
- Output IP3: +37 dBm
- Single Supply: +3V to +5V
- 50 Ohm Matched Input/Output
- 16 Lead 3x3mm QFN Package: 9 mm²

Functional Diagram

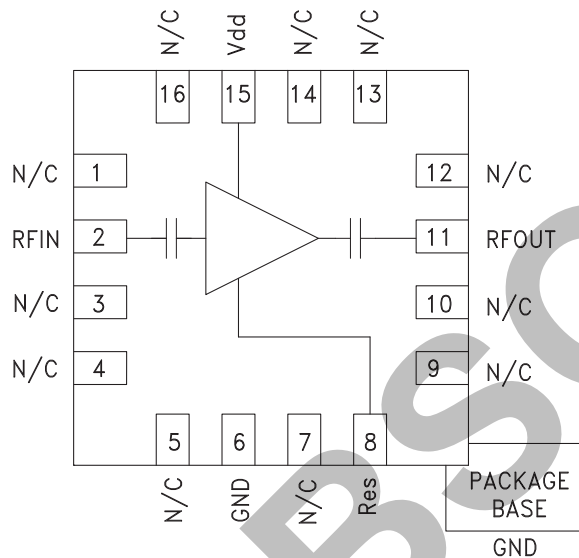

General Description

The HMC617LP3(E) is a GaAs PHEMT MMIC Low Noise Amplifier that is ideal for Cellular/3G and LTE/WiMAX/4G basestation front-end receivers operating between 550 and 1200 MHz. The amplifier has been optimized to provide 0.5 dB noise figure, 16 dB gain and +37 dBm output IP3 from a single supply of +5V. Input and output return losses are excellent and the LNA requires minimal external matching and bias decoupling components. The HMC617LP3(E) shares the same package and pinout with the HMC618LP3(E) 1.7 - 2.2 GHz LNA. The HMC617LP3(E) can be biased with +3V to +5V and features an externally adjustable supply current which allows the designer to tailor the linearity performance of the LNA for each application. The HMC617LP3(E) offers improved noise figure versus the previously released HMC372LP3(E) and the HMC376LP3(E).

Electrical Specifications, $T_A = +25^\circ\text{C}$, $R_{\text{bias}} = 3.92\text{k Ohms}^*$

Parameter	Vdd = +3 Vdc						Vdd = +5 Vdc						Units
	Min.	Typ.	Max.	Min.	Typ.	Max.	Min.	Typ.	Max.	Min.	Typ.	Max.	
Frequency Range	698 - 960			550 - 1200			698 - 960			550 - 1200			MHz
Gain	13	16		11	15		13.5	16		11.5	16		dB
Gain Variation Over Temperature	0.003			0.003			0.005			0.005			dB/°C
Noise Figure	0.5		0.8	0.5		1.1	0.55		0.85	0.6		1.1	dB
Input Return Loss	28			22			22			17			dB
Output Return Loss	12			14			12			15			dB
Output Power for 1 dB Compression (P1dB)	14	16		12.5	16		18.5	21		16.5	20		dBm
Saturated Output Power (Psat)	17			16.5			21			20.5			dBm
Output Third Order Intercept (IP3)	31			30			37			37			dBm
Supply Current (Idd)	30		45	30		45	88		115	88		115	mA

* Rbias resistor sets current, see application circuit herein



Broadband Gain & Return Loss [1] [2]

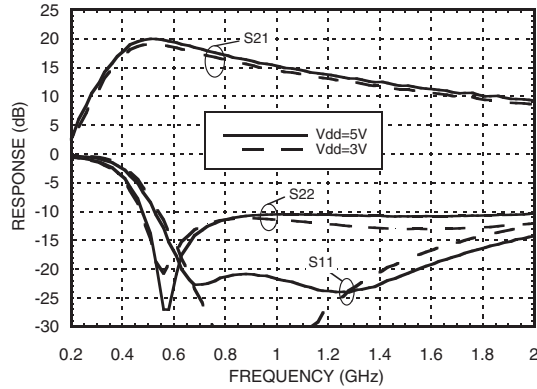

Gain vs. Temperature [1]

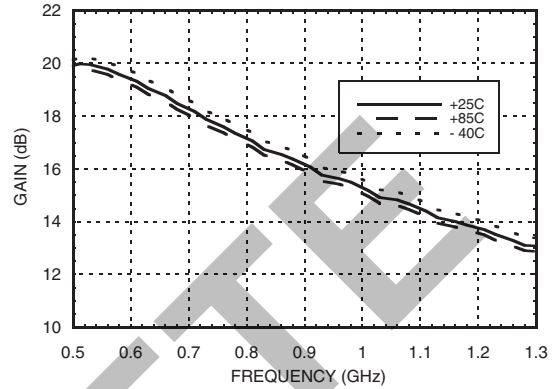

Gain vs. Temperature [2]

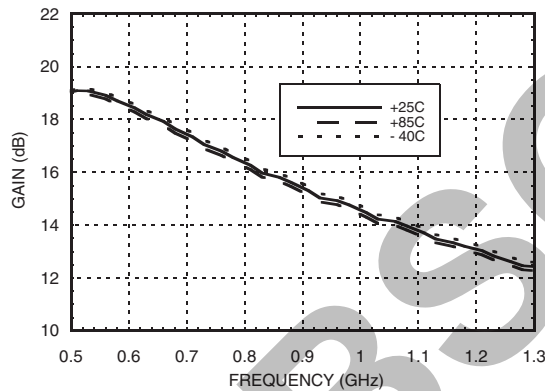

Input Return Loss vs. Temperature [1]

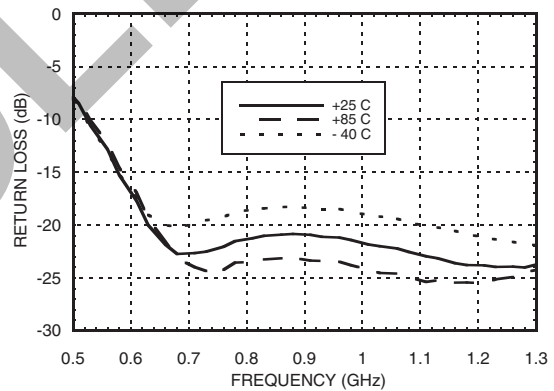

Output Return Loss vs. Temperature [1]

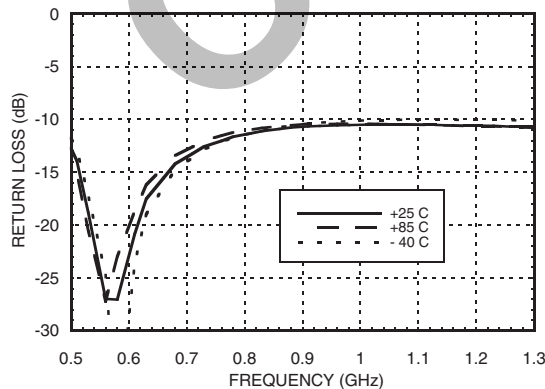

Reverse Isolation vs. Temperature [1]

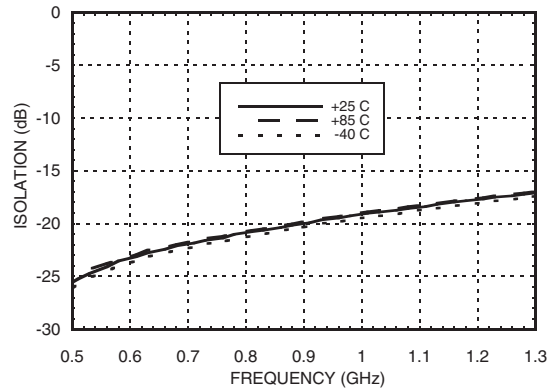

[1] Vdd = 5V, Rbias = 3.92K [2] Vdd = 3V, Rbias = 3.92K

Information furnished by Analog Devices is believed to be accurate and reliable. However, no responsibility is assumed by Analog Devices for its use, nor for any infringements of patents or other rights of third parties that may result from its use. Specifications subject to change without notice. No license is granted by implication or otherwise under any patent or patent rights of Analog Devices. Trademarks and registered trademarks are the property of their respective owners.

For price, delivery, and to place orders: Analog Devices, Inc., One Technology Way, P.O. Box 9106, Norwood, MA 02062-9106 Phone: 781-329-4700 • Order online at www.analog.com Application Support: Phone: 1-800-ANALOG-D



Noise Figure vs. Temperature [1] [2] [4]

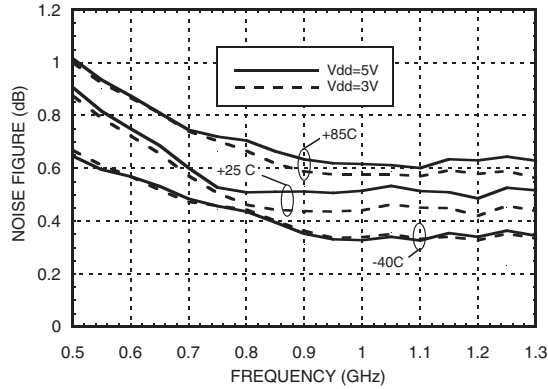

P1dB vs. Temperature [1] [2]

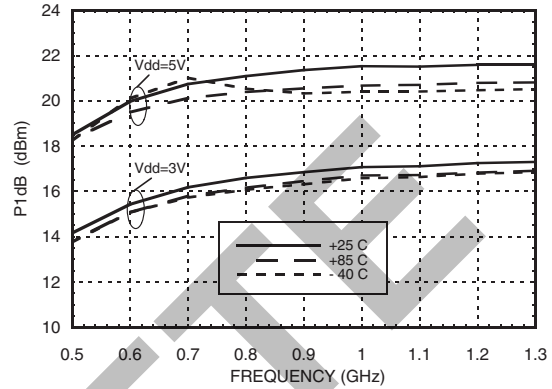

Psat vs. Temperature [1] [2]

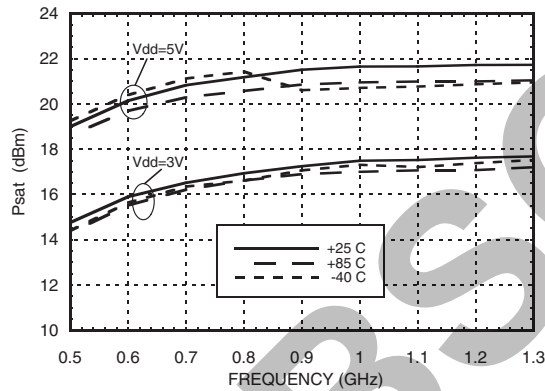

Output IP3 vs. Temperature [1] [2]

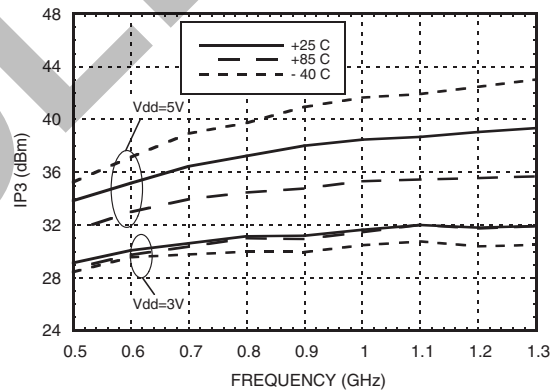

Output IP3 and Idd vs. Supply Voltage @ 700 MHz [3]

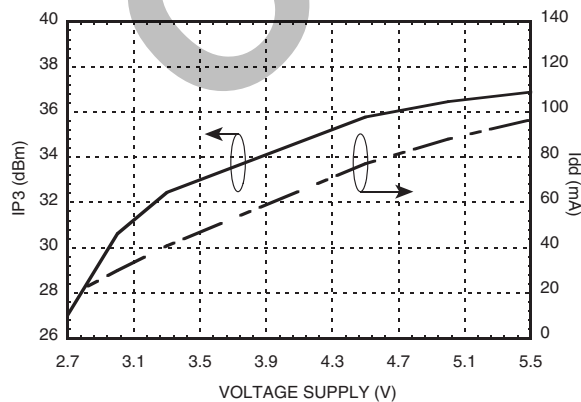

Output IP3 and Idd vs. Supply Voltage @ 900 MHz [3]

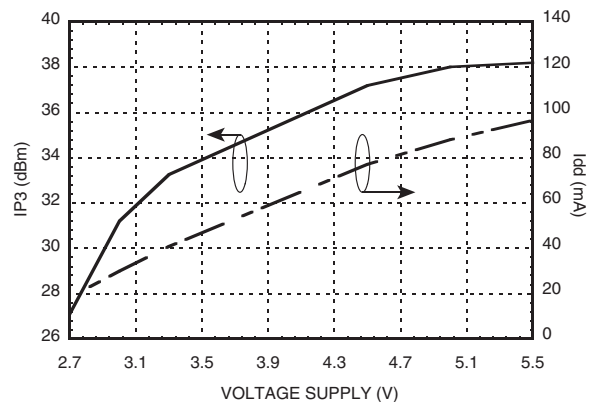

[1] Vdd = 5V, Rbias = 3.92K [2] Vdd = 3V, Rbias = 3.92K

[3] Rbias = 3.92K [4] Measurement reference plane shown on evaluation PCB drawing.



Power Compression @ 700 MHz [1]

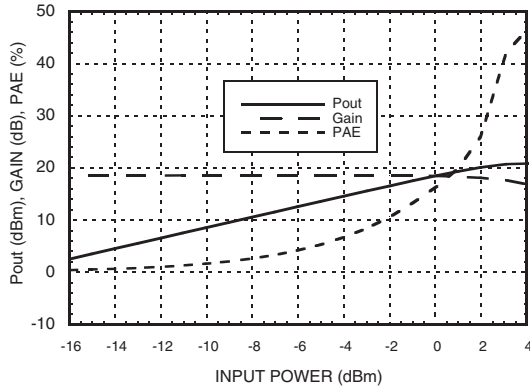

Power Compression @ 700 MHz [2]

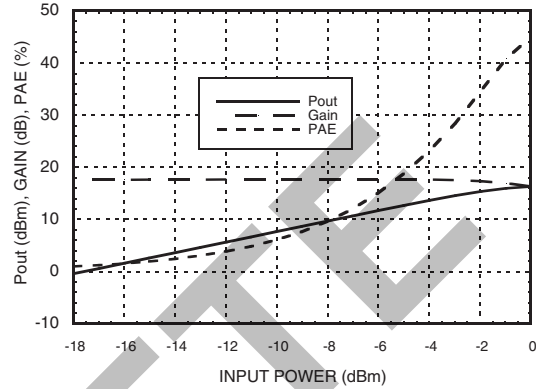

Power Compression @ 900 MHz [1]

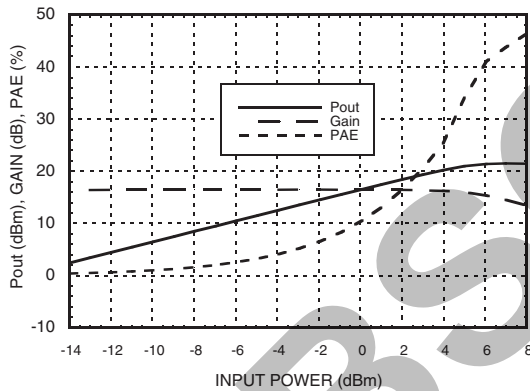

Power Compression @ 900 MHz [2]

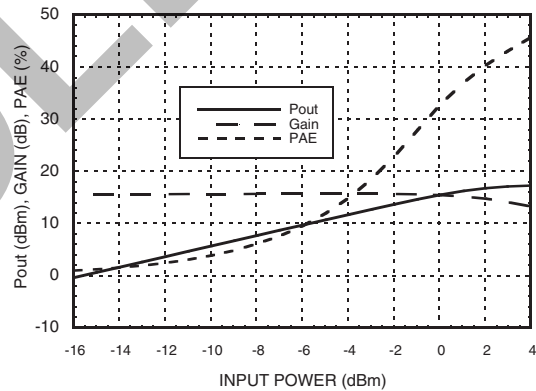

Gain, Power & Noise Figure vs. Supply Voltage @ 700 MHz [3]

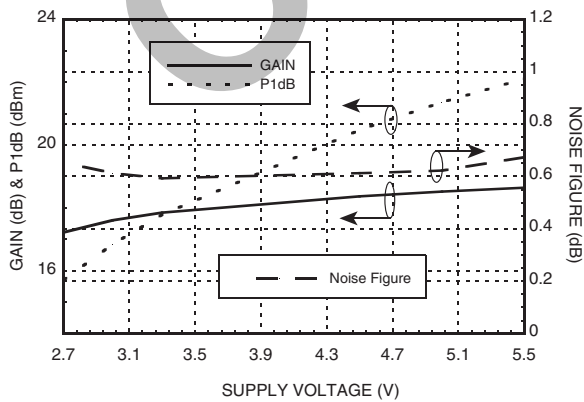

Gain, Power & Noise Figure vs. Supply Voltage @ 900 MHz [3]

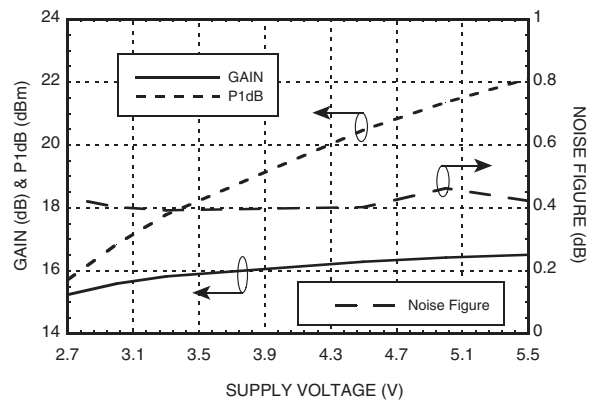

[1] Vdd = 5V, Rbias = 3.92K [2] Vdd = 3V, Rbias = 3.92K [3] Rbias = 3.92K

Information furnished by Analog Devices is believed to be accurate and reliable. However, no responsibility is assumed by Analog Devices for its use, nor for any infringements of patents or other rights of third parties that may result from its use. Specifications subject to change without notice. No license is granted by implication or otherwise under any patent or patent rights of Analog Devices. Trademarks and registered trademarks are the property of their respective owners.

For price, delivery, and to place orders: Analog Devices, Inc., One Technology Way, P.O. Box 9106, Norwood, MA 02062-9106 Phone: 781-329-4700 • Order online at www.analog.com Application Support: Phone: 1-800-ANALOG-D



Output IP3 vs. Rbias @ 700 MHz

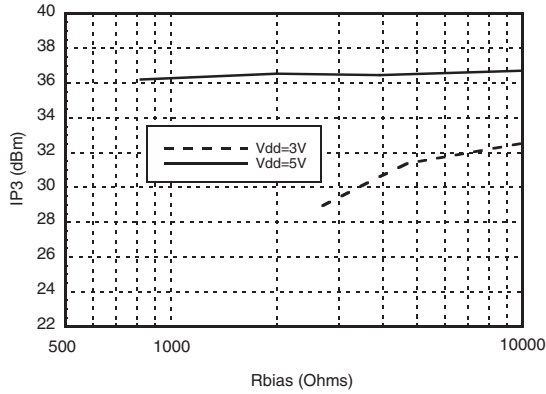

Gain, Noise Figure & Rbias @ 700 MHz

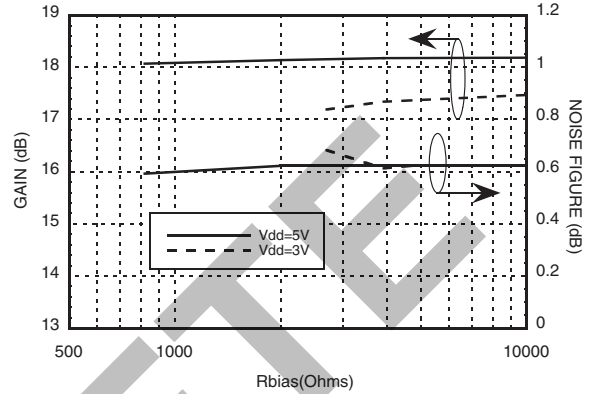

Output IP3 vs. Rbias @ 900 MHz

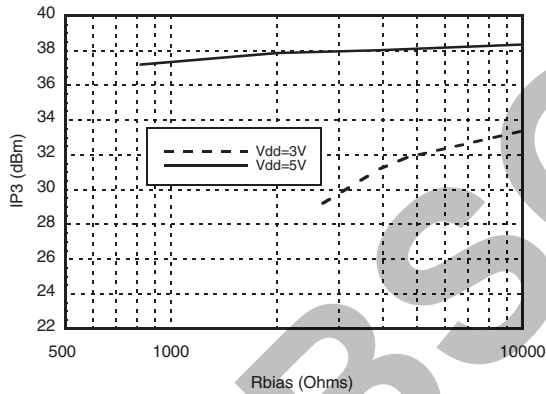

Gain, Noise Figure & Rbias @ 900 MHz

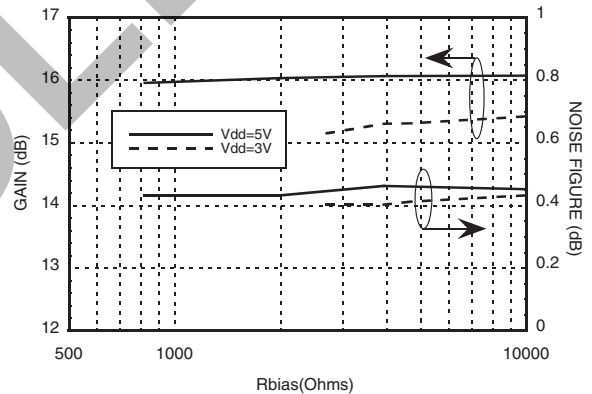

**Absolute Bias Resistor
Range & Recommended Bias Resistor Values for Idd**

Vdd (V)	Rbias			Idd (mA)
	Min	Max	Recommended	
3V	1K [1]	Open Circuit	2.7k	24
			3.92k	30
			4.7k	33
			10k	40
5V	0	Open Circuit	820	65
			2k	78
			3.92k	88
			10k	90

[1] With Vdd= 3V and Rbias < 1K Ohm may result in the part becoming conditionally stable which is not recommended.

GaAs SMT PHEMT LOW NOISE AMPLIFIER, 0.55 - 1.2 GHz



Absolute Maximum Ratings

Drain Bias Voltage (Vdd)	+6V
RF Input Power (RFIN) (Vdd = +5 Vdc)	+10 dBm
Channel Temperature	150 °C
Continuous Pdiss (T= 85 °C) (derate 8.33 mW/°C above 85 °C)	0.54 W
Thermal Resistance (channel to ground paddle)	120 °C/W
Storage Temperature	-65 to +150 °C
Operating Temperature	-40 to +85 °C

Typical Supply Current vs. Vdd (Rbias = 3.92k)

Vdd (V)	Idd (mA)
2.7	18
3.0	30
3.3	41
4.5	77
5.0	88
5.5	97

Note: Amplifier will operate over full voltage ranges shown above.

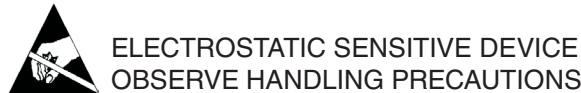

Outline Drawing

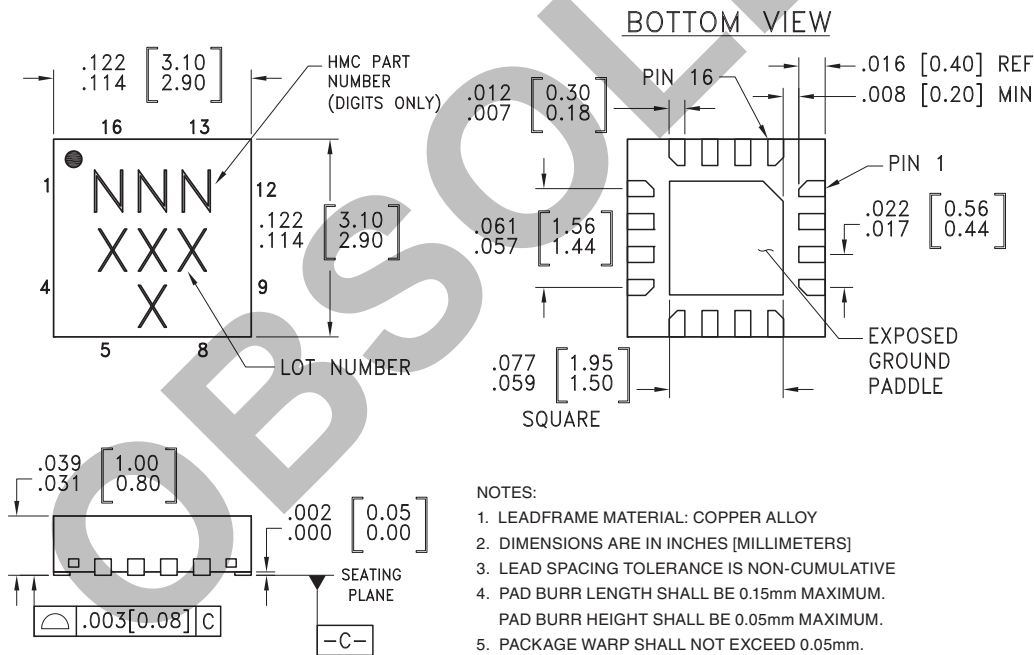

Package Information



Part Number	Package Body Material	Lead Finish	MSL Rating	Package Marking ^[3]
HMC617LP3	Low Stress Injection Molded Plastic	Sn/Pb Solder	MSL1 ^[1]	617 XXXX
HMC617LP3E	RoHS-compliant Low Stress Injection Molded Plastic	100% matte Sn	MSL1 ^[2]	617 XXXX

[1] Max peak reflow temperature of 235 °C

[2] Max peak reflow temperature of 260 °C

[3] 4-Digit lot number XXXX

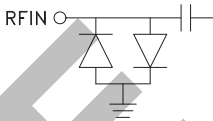

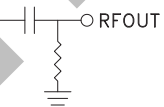
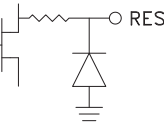
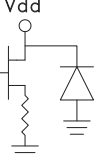
Pin Descriptions

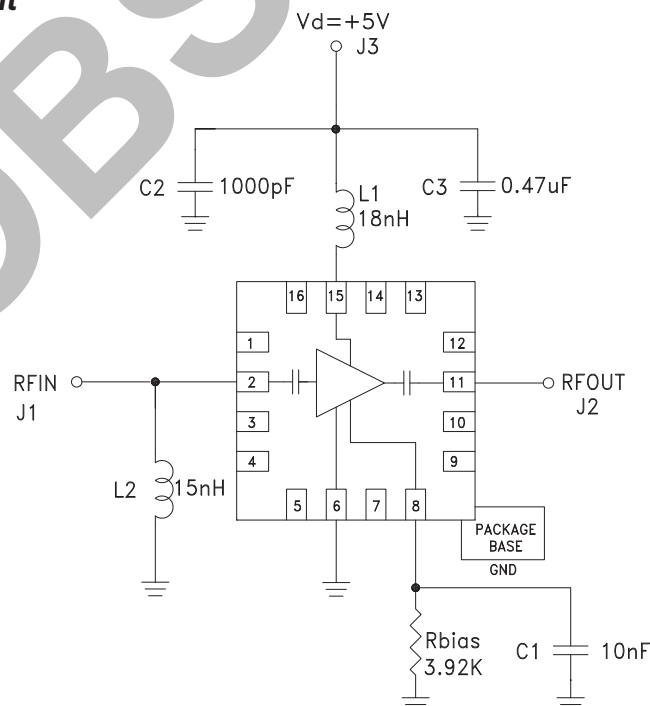
Pin Number	Function	Description	Interface Schematic
1, 3 - 5, 7, 9, 10, 12 - 14, 16	N/C	No connection required. These pins may be connected to RF/DC ground without affecting performance.	
2	RFIN	This pin is matched to 50 Ohms.	
6	GND	This pin and ground paddle must be connected to RF/DC ground.	
11	RFOUT	This pin is matched to 50 Ohms.	
8	RES	This pin is used to set the DC current of the amplifier by selection of external bias resistor. See application circuit.	
15	Vdd	Power Supply Voltage. Choke inductor and bypass capacitors are required. See application circuit.	

Application Circuit

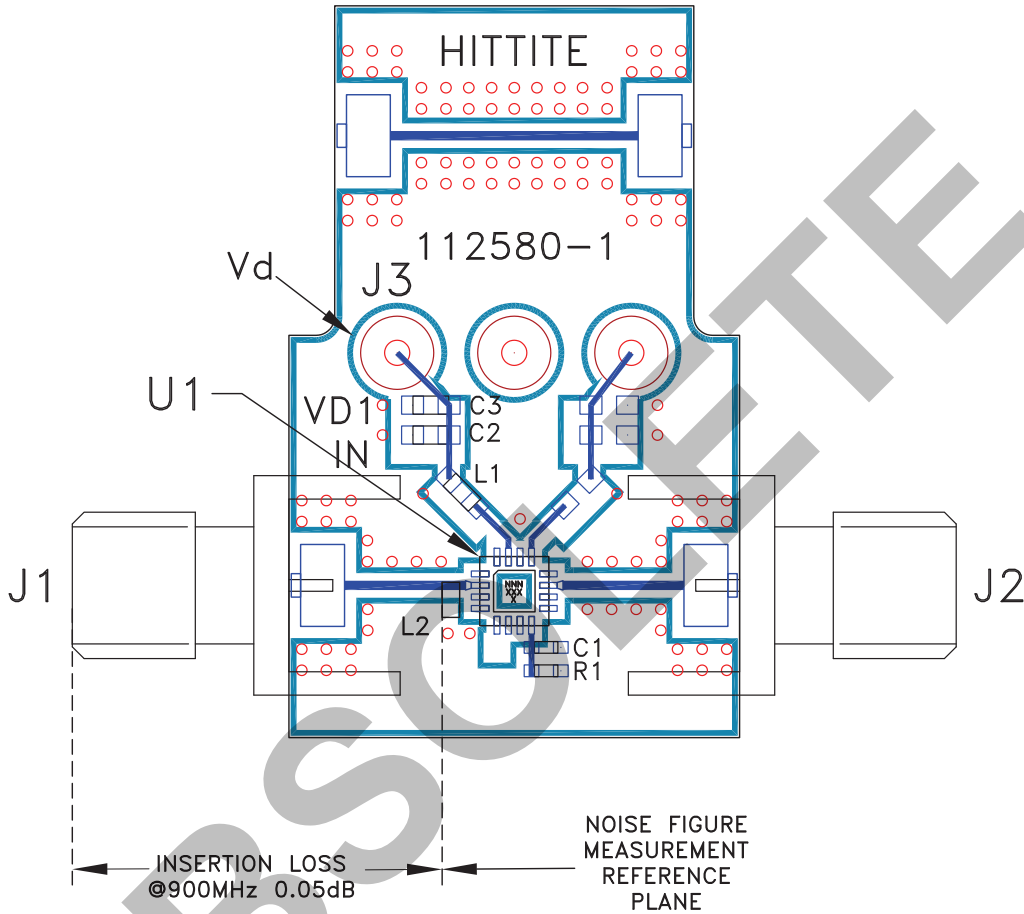

Evaluation PCB



List of Materials for Evaluation PCB 118357 [1]

Item	Description
J1, J2	PCB Mount SMA RF Connector
J3, J4	DC Pin
C1	10nF Capacitor, 0402 Pkg.
C2	1000 pF Capacitor, 0603 Pkg.
C3	0.47µF Capacitor, 0603 Pkg.
L1	18 nH, Inductor, 0603 Pkg.
L2	15 nH, Inductor, 0402 Pkg.
R1	3.92K Ohm Resistor, 0402 Pkg.
U1	HMC617LP3(E) Amplifier
PCB [2]	112580 Evaluation PCB

[1] Reference this number when ordering complete evaluation PCB

[2] Circuit Board Material: Rogers 4350.

The circuit board used in this application should use RF circuit design techniques. Signal lines should have 50 Ohm impedance while the package ground leads and exposed paddle should be connected directly to the ground plane similar to that shown. A sufficient number of via holes should be used to connect the top and bottom ground planes. The evaluation board should be mounted to an appropriate heat sink. The evaluation circuit board shown is available from Hittite upon request.

X-ON Electronics

Largest Supplier of Electrical and Electronic Components

Click to view similar products for [RF Development Tools](#) category:

Click to view products by [Analog Devices](#) manufacturer:

Other Similar products are found below :

[MAAM-011117](#) [MAAP-015036-DIEEV2](#) [EV1HMC1113LP5](#) [EV1HMC6146BLC5A](#) [EV1HMC637ALP5](#) [EVAL-ADG919EBZ](#) [ADL5363-EVALZ](#) [LMV228SDEVAL](#) [SKYA21001-EVB](#) [SMP1331-085-EVB](#) [EV1HMC618ALP3](#) [EVAL01-HMC1041LC4](#) [MAAL-011111-000SMB](#) [MAAM-009633-001SMB](#) [MASW-000936-001SMB](#) [107712-HMC369LP3](#) [107780-HMC322ALP4](#) [SP000416870](#) [EV1HMC470ALP3](#) [EV1HMC520ALC4](#) [EV1HMC244AG16](#) [MAX2614EVKIT#](#) [124694-HMC742ALP5](#) [SC20ASATEA-8GB-STD](#) [MAX2837EVKIT+](#) [MAX2612EVKIT#](#) [MAX2692EVKIT#](#) [EV1HMC629ALP4E](#) [SKY12343-364LF-EVB](#) [108703-HMC452QS16G](#) [EV1HMC863ALC4](#) [119197-HMC658LP2](#) [EV1HMC647ALP6](#) [ADL5725-EVALZ](#) [106815-HMC441LM1](#) [EV1HMC1018ALP4](#) [UXN14M9PE](#) [MAX2016EVKIT](#) [EV1HMC939ALP4](#) [MAX2410EVKIT](#) [MAX2204EVKIT+](#) [EV1HMC8073LP3D](#) [SIMSA868-DKL](#) [SIMSA868C-DKL](#) [SKY65806-636EK1](#) [SKY68020-11EK1](#) [SKY67159-396EK1](#) [SKY66181-11-EK1](#) [SKY65804-696EK1](#) [SKY13396-397LF-EVB](#)