

v00.0210

**13 Gbps, FAST RISE TIME D-TYPE FLIP-FLOP
w/ PROGRAMMABLE OUTPUT VOLTAGE**



Typical Applications

The HMC723LP3E is ideal for:

- RF ATE Applications
- Broadband Test & Measurement
- Serial Data Transmission up to 13 Gbps
- Digital Logic Systems up to 13 GHz

Features

- Supports High Data Rates: up to 13 Gbps
- Differential & Single-Ended Operation
- Fast Rise and Fall Times: 19 / 17 ps
- Low Power Consumption: 260 mW typ.
- Programmable Differential Output Voltage Swing: 700 - 1300 mV
- Propagation Delay: 105 ps
- Single Supply: -3.3V
- 16 Lead 3x3mm SMT Package: 9mm²

Functional Diagram

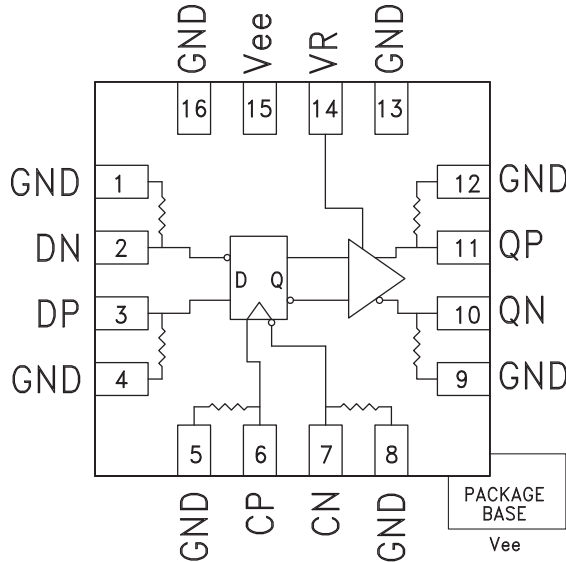

General Description

The HMC723LP3E is a D-type Flip Flop designed to support data transmission rates of up to 13 Gbps, and clock frequencies as high as 13 GHz. During normal operation, data is transferred to the outputs on the positive edge of the clock. Reversing the clock inputs allows for negative-edge triggered applications. The HMC723LP3E also features an output level control pin, VR, which allows for loss compensation or for signal level optimization.

All input signals to the HMC723LP3E are terminated with 50 Ohms to ground on-chip, and maybe either AC or DC coupled. The differential outputs of the HMC723LP3E may be either AC or DC coupled. Outputs can be connected directly to a 50 Ohm to ground terminated system, while DC blocking capacitors may be used if the terminating system is 50 Ohms to a non-ground DC voltage. The HMC723LP3E operates from a single -3.3V DC supply and is available in a RoHS compliant 3x3 mm SMT package.

Electrical Specifications, $T_A = +25^\circ\text{C}$, $V_{ee} = -3.3\text{V}$

Parameter	Conditions	Min.	Typ.	Max	Units
Power Supply Voltage		-3.6	-3.3	-3.0	V
Power Supply Current			80		mA
Maximum Data Rate			13		Gbps
Maximum Clock Rate			13		GHz
Input High Voltage		-0.5		0.5	V
Input Low Voltage		-1.0		0.0	V
Input Return Loss	Frequency <13 GHz		10		dB
Output Amplitude	Single-Ended, peak-to-peak		550		mVp-p
	Differential, peak-to-peak		1100		mVp-p
Output High Voltage			-10		mV

Information furnished by Analog Devices is believed to be accurate and reliable. However, no responsibility is assumed by Analog Devices for its use, nor for any infringements of patents or other rights of third parties that may result from its use. Specifications subject to change without notice. No license is granted by implication or otherwise under any patent or patent rights of Analog Devices. Trademarks and registered trademarks are the property of their respective owners.

For price, delivery, and to place orders: Analog Devices, Inc., One Technology Way, P.O. Box 9106, Norwood, MA 02062-9106 Phone: 781-329-4700 • Order online at www.analog.com Application Support: Phone: 1-800-ANALOG-D



13 Gbps, FAST RISE TIME D-TYPE FLIP-FLOP w/ PROGRAMMABLE OUTPUT VOLTAGE

Electrical Specifications, (continued)

Parameter	Conditions	Min.	Typ.	Max	Units
Output Low Voltage			-570		mV
Output Rise / Fall Time	Differential, 20% - 80%		19 / 17		ps
Output Return Loss	Frequency <13 GHz		10		dB
Random Jitter Jr	rms			0.2	ps rms
Deterministic Jitter, Jd	peak-to-peak, 2 ¹⁵ -1 PRBS input [1]		2		ps, pp
Propagation Delay Clock to Data, td			105		ps
Clock Phase Margin	13 GHz		320		deg
Set Up & Hold Time, t _{SH}			6		ps

[1] Deterministic jitter calculated by simultaneously measuring the jitter of a 300 mV, 13 GHz, 2¹⁵-1 PRBS input, and a single-ended output

DC Current vs. Supply Voltage [1] [2]

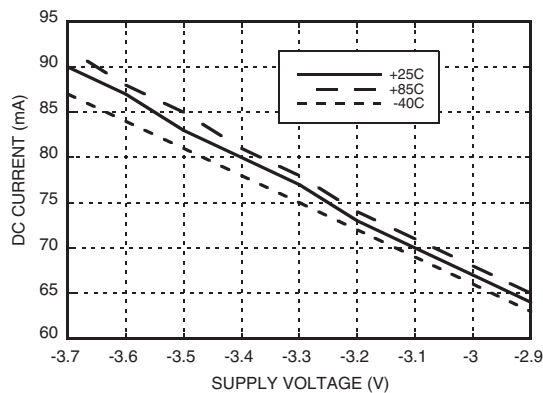

Output Differential vs. Supply Voltage [1] [3]

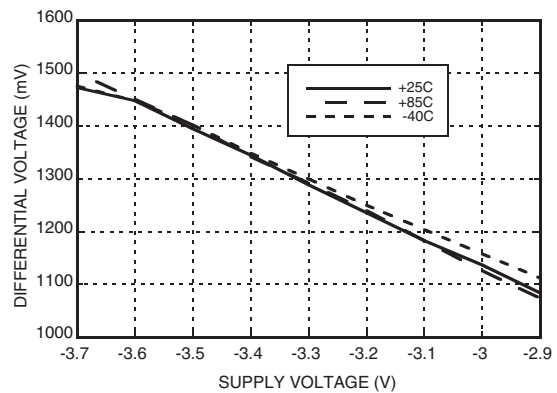

Output Differential vs. VR [3]

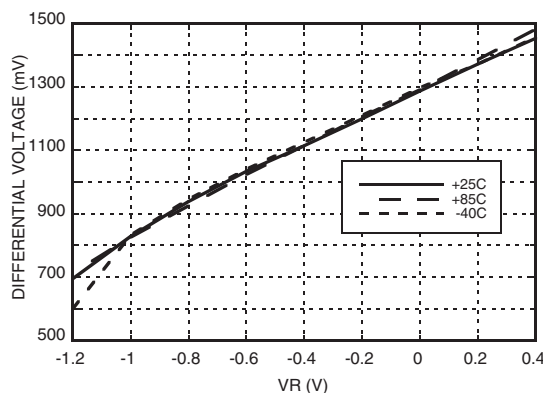

Output Differential vs. Frequency [1]

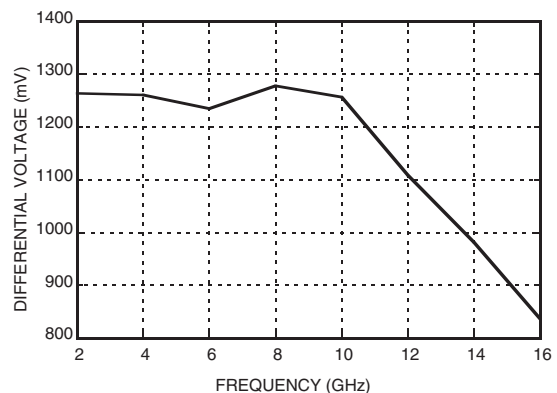

[1] VR = 0.0V

[2] Frequency = 13 GHz

[3] Frequency = 10 GHz

Information furnished by Analog Devices is believed to be accurate and reliable. However, no responsibility is assumed by Analog Devices for its use, nor for any infringements of patents or other rights of third parties that may result from its use. Specifications subject to change without notice. No license is granted by implication or otherwise under any patent or patent rights of Analog Devices. Trademarks and registered trademarks are the property of their respective owners.

For price, delivery, and to place orders: Analog Devices, Inc., One Technology Way, P.O. Box 9106, Norwood, MA 02062-9106
Phone: 781-329-4700 • Order online at www.analog.com
Application Support: Phone: 1-800-ANALOG-D



13 Gbps, FAST RISE TIME D-TYPE FLIP-FLOP w/ PROGRAMMABLE OUTPUT VOLTAGE

3

HIGH SPEED LOGIC - SMT

Rise / Fall Time vs. Supply Voltage [2]

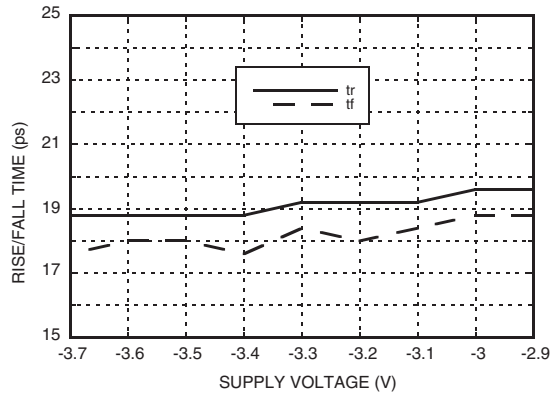

Rise / Fall Time vs. VR [2]

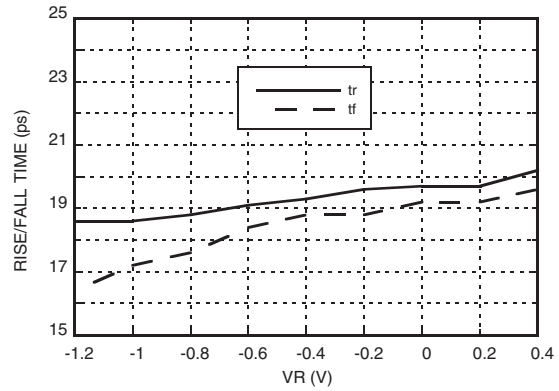

Input Return Loss vs. Frequency

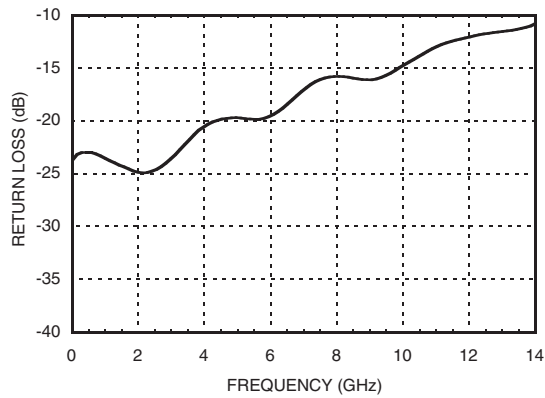

Output Return Loss vs. Frequency

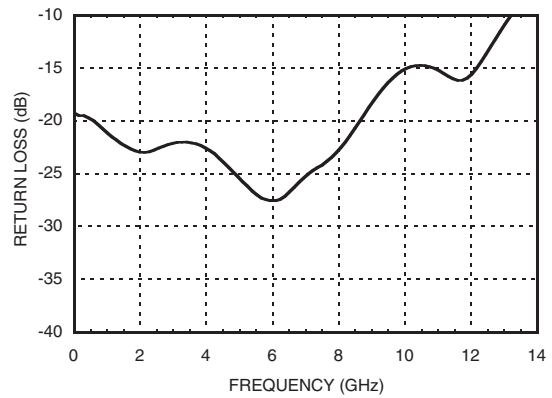

[1] VR = 0.0V

[2] Frequency = 13 GHz

[3] Frequency = 10 GHz

Information furnished by Analog Devices is believed to be accurate and reliable. However, no responsibility is assumed by Analog Devices for its use, nor for any infringements of patents or other rights of third parties that may result from its use. Specifications subject to change without notice. No license is granted by implication or otherwise under any patent or patent rights of Analog Devices. Trademarks and registered trademarks are the property of their respective owners.

For price, delivery, and to place orders: Analog Devices, Inc., One Technology Way, P.O. Box 9106, Norwood, MA 02062-9106 Phone: 781-329-4700 • Order online at www.analog.com Application Support: Phone: 1-800-ANALOG-D



13 Gbps, FAST RISE TIME D-TYPE FLIP-FLOP w/ PROGRAMMABLE OUTPUT VOLTAGE

Eye Diagram

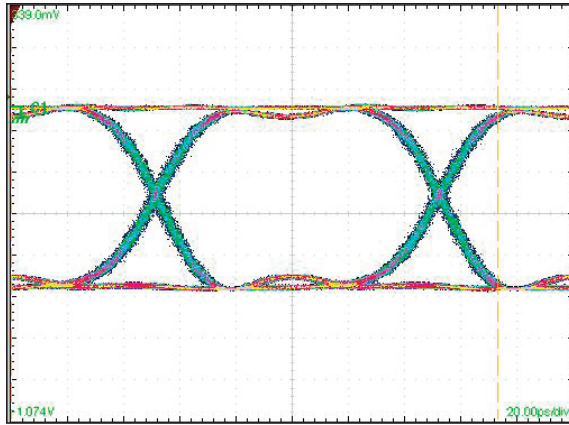

[1] Test Conditions:
 Pattern generated with an Agilent N4903A Serial BERT.
 Eye Diagram presented on a Tektronix CSA 8000.
 Device input = 13 Gbps PN code, $V_{in} = 300mV_{p-p}$ differential.
 Both output channels shown.

Timing Diagram

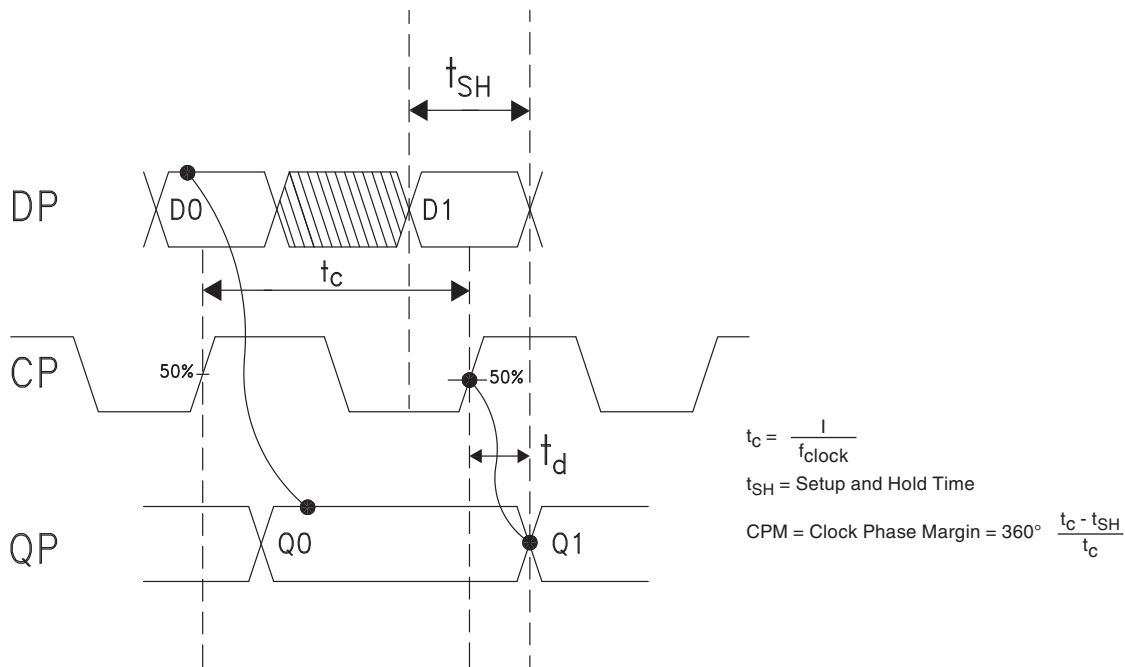

Truth Table

Input		Outputs
D	C	Q
L	L -> H	L
H	L -> H	H

Notes:
 D = DP - DN
 C = CP - CN
 Q = QP - QN
 H - Positive voltage level
 L - Negative voltage level

Information furnished by Analog Devices is believed to be accurate and reliable. However, no responsibility is assumed by Analog Devices for its use, nor for any infringements of patents or other rights of third parties that may result from its use. Specifications subject to change without notice. No license is granted by implication or otherwise under any patent or patent rights of Analog Devices. Trademarks and registered trademarks are the property of their respective owners.

For price, delivery, and to place orders: Analog Devices, Inc., One Technology Way, P.O. Box 9106, Norwood, MA 02062-9106
 Phone: 781-329-4700 • Order online at www.analog.com
 Application Support: Phone: 1-800-ANALOG-D

13 Gbps, FAST RISE TIME D-TYPE FLIP-FLOP w/ PROGRAMMABLE OUTPUT VOLTAGE



Absolute Maximum Ratings

Power Supply Voltage (Vee)	-3.75V to +0.5V
Input Signals	-2V to +0.5V
Output Signals	-1.5V to +1V
Storage Temperature	-65°C to +150°C
Operating Temperature	-40°C to +85°C



ELECTROSTATIC SENSITIVE DEVICE
OBSERVE HANDLING PRECAUTIONS

3

HIGH SPEED LOGIC - SMT

Outline Drawing

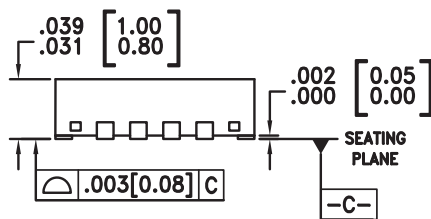
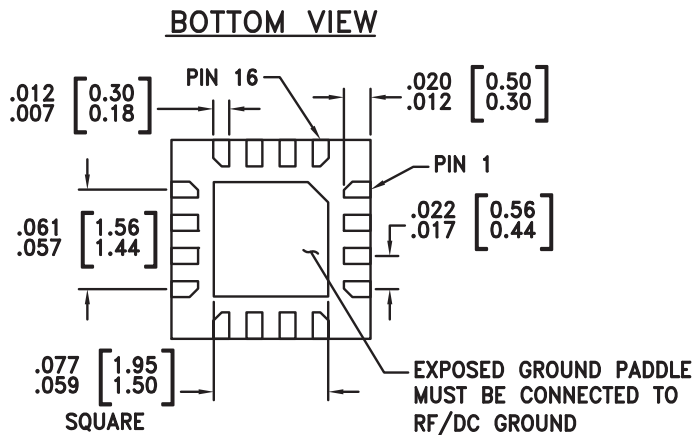
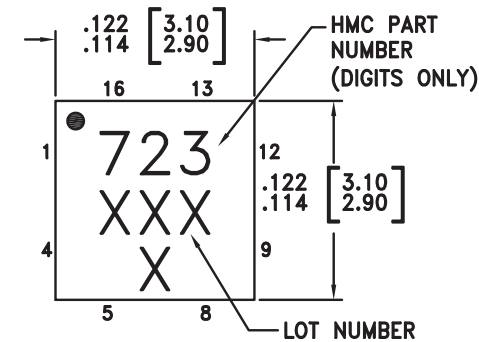

NOTES:

- LEADFRAME MATERIAL: COPPER ALLOY
- DIMENSIONS ARE IN INCHES [MILLIMETERS]
- LEAD SPACING TOLERANCE IS NON-CUMULATIVE
- PAD BURR LENGTH SHALL BE 0.15mm MAXIMUM.
PAD BURR HEIGHT SHALL BE 0.05mm MAXIMUM.
- PACKAGE WARP SHALL NOT EXCEED 0.05mm.
- ALL GROUND LEADS AND GROUND PADDLE MUST BE SOLDERED TO PCB RF GROUND.
- REFER TO HITTITE APPLICATION NOTE FOR SUGGESTED LAND PATTERN.

Package Information

Part Number	Package Body Material	Lead Finish	MSL Rating	Package Marking ^[3]
HMC723LP3E	RoHS-compliant Low Stress Injection Molded Plastic	100% matte Sn	MSL1 ^[2]	723 XXXX

[1] Max peak reflow temperature of 235 °C



[2] Max peak reflow temperature of 260 °C

[3] 4-Digit lot number XXXX

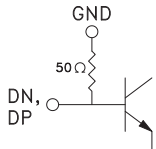
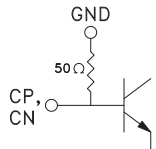
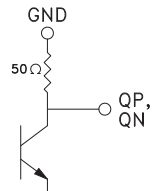

13 Gbps, FAST RISE TIME D-TYPE FLIP-FLOP w/ PROGRAMMABLE OUTPUT VOLTAGE

Pin Descriptions

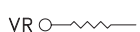
Pin Number	Function	Description	Interface Schematic
1, 4, 5, 8, 9, 12	GND	Signal Grounds	
2, 3	DN, DP	Data Inputs	
6, 7	CP, CN	Clock Inputs	
10, 11	QN, QP	Data Outputs	
13, 16	GND	Supply Ground	
14	VR	Output level control. Output level may be adjusted by either applying a voltage to VR per "Output Differential vs. VR" plot, or by tying VR to GND with a resistor per the following equation: $V_o(R) = 1.2 / (2.1 + R)$, R in k Ω	
15, Package Base	Vee	Negative Supply	



**13 Gbps, FAST RISE TIME D-TYPE FLIP-FLOP
w/ PROGRAMMABLE OUTPUT VOLTAGE**

Evaluation PCB

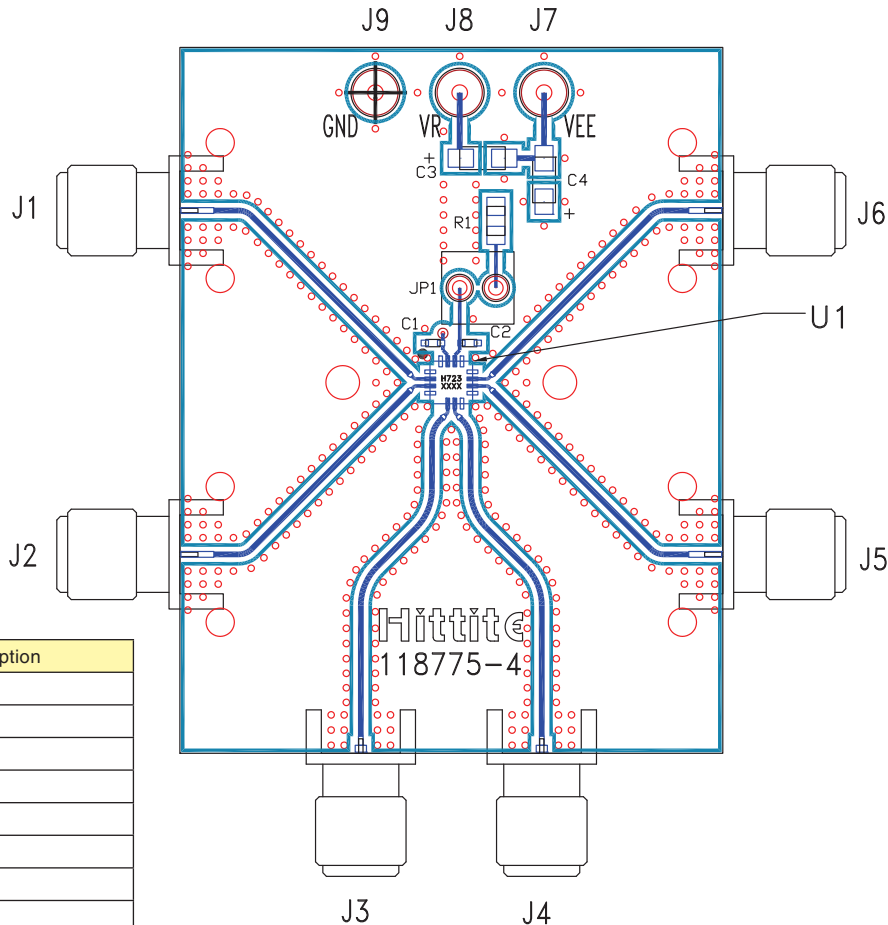

Item	Description
J1	DN
J2	DP
J3	CP
J4	CN
J5	QN
J6	QP
J7	Vee
J8	VR
J9	GND

List of Materials for Evaluation PCB 118777 [1]

Item	Description
J1 - J6	PCB Mount SMA RF Connectors
J7 - J9	DC Pin
C1, C2	100 pF Capacitor, 0402 Pkg.
C3, C4	4.7 μF Capacitor, Tantalum
R1	10 Ohm Resistor, 0603 Pkg.
U1	HMC723LP3E High Speed Logic, D-Type Flip-Flop
PCB [2]	118775 Evaluation Board

[1] Reference this number when ordering complete evaluation PCB

[2] Circuit Board Material: Rogers 4350 or Arlon 25FR

The circuit board used in the application should use RF circuit design techniques. Signal lines should have 50 Ohm impedance while the package ground leads should be connected directly to the ground plane similar to that shown. The exposed package base should be connected to Vee. A sufficient number of via holes should be used to connect the top and bottom ground planes. The evaluation circuit board shown is available from Hittite upon request.

**13 Gbps, FAST RISE TIME D-TYPE FLIP-FLOP
w/ PROGRAMMABLE OUTPUT VOLTAGE**



Application Circuit

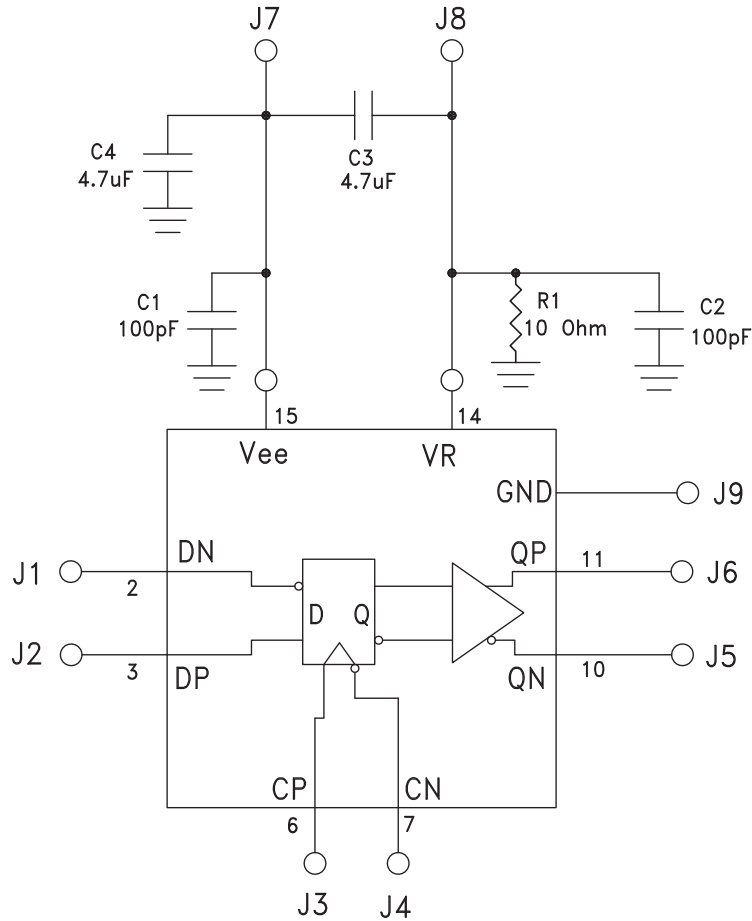

X-ON Electronics

Largest Supplier of Electrical and Electronic Components

Click to view similar products for [Other Development Tools](#) category:

Click to view products by [Analog Devices](#) manufacturer:

Other Similar products are found below :

[DS100BR410EVK-4/NOPB](#) [BK0004](#) [BK0012](#) [SN65MLVD2-3EVM](#) [DS80EP100-EVK](#) [MAX9684EVKIT#](#) [MAX4952AEVKIT+](#) [ESD-EVM-001](#) [MAX14842EVKIT+](#) [EVAL01-HMC749LC3C](#) [410-320](#) [TPD6F002-Q1EVM](#) [TS9002DB](#) [DS80PCI800EVK/NOPB](#) [118777-HMC722LC3C](#) [118777-HMC723LC3C](#) [118777-HMC678LC3C](#) [DC1765A-A](#) [125614-HMC851LC3C](#) [TPD1E05U06DPYEVM](#) [SN65LVDM31-32BEVM](#) [DC2062A-A](#) [NB4N855SMEVB](#) [LMH6321MR-EVAL/NOPB](#) [EVAL01-HMC747LC3C](#) [4537](#) [DK-M3F-1.8-TRK-1.5-S](#) [DK-M3-FS-1.8-1.5-M12/16](#) [DK-M3L-1.8-TRK-6.0-S](#) [DK-M3-LS-1.8-6](#) [ADALM1000](#) [ADALP2000](#) [EVAL-CN0202-SDPZ](#) [EVAL-CN0203-SDPZ](#) [EVAL-CN0204-SDPZ](#) [EVAL-CN0209-SDPZ](#) [EVAL-CN0225-SDPZ](#) [EVAL-CN0229-SDPZ](#) [EVAL-CN0251-SDPZ](#) [EVAL-CN0272-SDPZ](#) [EVAL-CN0301-SDPZ](#) [EVAL-CN0325-SDPZ](#) [EVAL-CN0355-PMDZ](#) [EVAL-CN0364-SDPZ](#) [EVAL-SDP-CB1Z](#) [EVAL-SDP-CS1Z](#) [DS1964SEVKIT#](#) [MAX14611EVKIT#](#) [MAX22088EVKIT#](#) [MAX4951AEEVKIT+](#)