



Typical Applications

The HMC602LP4(E) is ideal for IF and RF applications in:

- Cellular/PCS/3G
- WiMAX, WiBro, WLAN, Fixed Wireless & Radar
- Power Monitoring & Control Circuitry
- Receiver Signal Strength Indication (RSSI)
- Automatic Gain & Power Control

Features

- Wide Dynamic Range: up to 70 dB
- High Accuracy: ± 1 dB with 60 dB Range Up To 6 GHz
- Fast: 10ns Output Response Time
- Supply Voltage: +5V
- Power-Down Mode
- Excellent Stability over Temperature
- Buffered Temperature Sensor Output
- Compact 4x4mm Leadless SMT Package

Functional Diagram

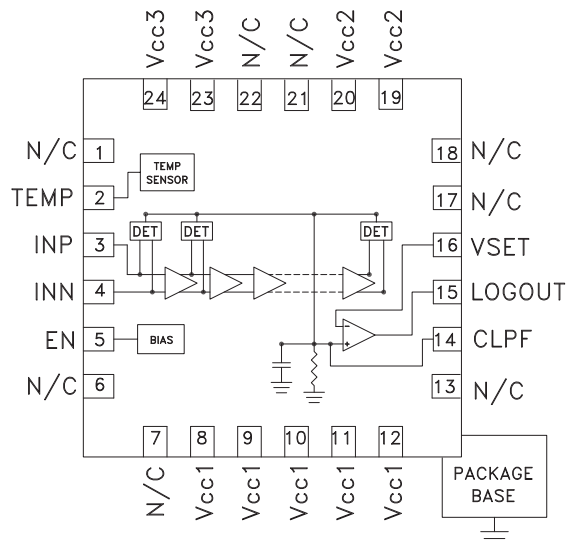

General Description

The HMC602LP4(E) Logarithmic Detector/Controller converts RF signals at its input, to a proportional DC voltage at its output. The HMC602LP4(E) employs a successive compression topology which delivers extremely high dynamic range and conversion accuracy over a wide input frequency range. As the input power is increased, successive amplifiers move into saturation one by one creating an accurate approximation of the logarithm function. The output of a series of square law detectors is summed, converted into voltage domain and buffered to drive the LOGOUT output. For detection mode, the LOGOUT pin is shorted to the VSET input, and will provide a nominal logarithmic slope of -25mV/dB and an intercept of 18 dBm (23 dBm for $f > 5.8$ GHz). The HMC602LP4(E) can also be used in the controller mode where an external voltage is applied to the VSET pin, to create an AGC or APC feedback loop.

Electrical Specifications, $T_A = +25C$, $EN = 5V$, V_{cc1} , V_{cc2} , $V_{cc3} = +5V$ [1]

Parameter	Typ.	Typ.	Typ.	Typ.	Typ.	Typ.	Typ.	Typ.	Typ.	Units
Input Frequency	50	100	900	1900	2200	3600	5800	7000	8000	MHz
± 3 dB Dynamic Range	69	70	71	71	71	68	66	61	56	dB
± 3 dB Dynamic Range Center	-24.5	-25	-25.5	-25.5	-25.5	-24	-23	-20.5	-19	dBm
± 1 dB Dynamic Range	61	61	62	62	63	62	63	56	49	dB
Output Intercept	18.2	18	18.7	19.8	20.2	23.1	24.4	23	21.6	dBm
Output Slope	-25.6	-25.5	-25.3	-25	-25	-24.6	-25.4	-27.5	-30	mV/dB
Temperature Sensitivity @ -10 dBm Input [2]	16	16	14	14	15	16	15	14	22	mdB/°C

[1] Detector mode measurements; LOGOUT (Pin 15) is shorted to VSET (Pin 16).

[2] Measured from $T_A = -40C$ to $T_A = +85C$

[3] C9 removed from production board

Parameter	Conditions	Min.	Typ.	Max.	Units
LOGOUT Interface					
Output Voltage Range		0		$V_{cc} - 1.0$	V
Output Fall Time	-10 dBm Input Pulsed; Measured from 10% to 90% [3]		9.5		ns
Output Rise Time	-10 dBm Input Pulsed; Measured from 10% to 70% [3]		10		ns
VSET Interface					
Input Impedance			30		k Ω
Input Voltage Range			0.25 to 2.0		V
Low Frequency Gain	VSET to LOGOUT		56		dB

Information furnished by Analog Devices is believed to be accurate and reliable. However, no responsibility is assumed by Analog Devices for its use, nor for any infringements of patents or other rights of third parties that may result from its use. Specifications subject to change without notice. No license is granted by implication or otherwise under any patent or patent rights of Analog Devices. Trademarks and registered trademarks are the property of their respective owners.

For price, delivery, and to place orders: Analog Devices, Inc., One Technology Way, P.O. Box 9106, Norwood, MA 02062-9106 Phone: 781-329-4700 • Order online at www.analog.com Application Support: Phone: 1-800-ANALOG-D



70 dB, LOGARITHMIC DETECTOR / CONTROLLER, 1 - 8000 MHz

Electrical Specifications, (continued)

Parameter	Conditions	Min.	Typ.	Max.	Units
Open Loop Corner Frequency			700		kHz
Power Down (EN) Interface					
Voltage Range for Normal Mode		0.8 x Vcc ^[4]		Vcc ^[4]	V
Voltage Range for Powerdown Mode		0		0.2 x Vcc ^[4]	V
Threshold Voltage			Vcc ^[4] /2		V
Power Supply (Vcc1, Vcc2, Vcc3)					
Operating Voltage Range		4.5		5.5	V
Supply Current in Normal Mode			113		mA
Supply Current in Power Down Mode			1		mA

[4] Vcc = Vcc1 = Vcc2 = Vcc3 = +5V

Test Conditions

Parameter	Condition
Vcc1, Vcc2, Vcc3	+5V
Input Zo	50Ω
T _A	+25C
Fin	900 MHz

LOGOUT Voltage & Error vs. Input Power, Fin = 50 MHz

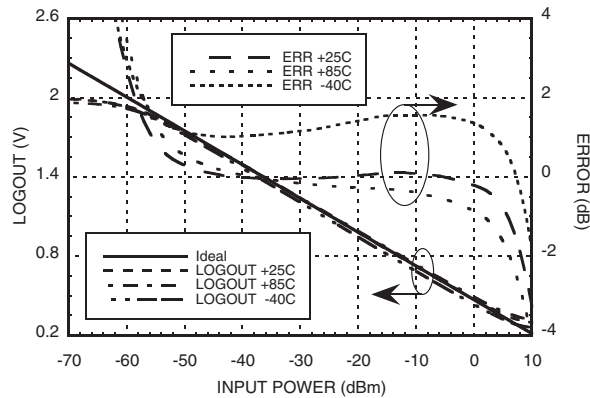

LOGOUT Voltage & Error vs. Input Power, Fin = 100 MHz

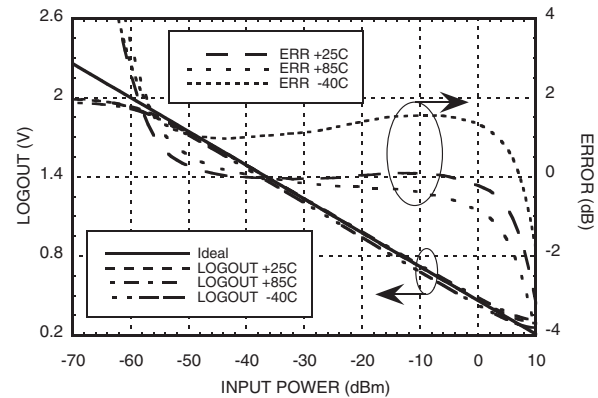

LOGOUT Voltage & Error vs. Input Power, Fin = 900 MHz

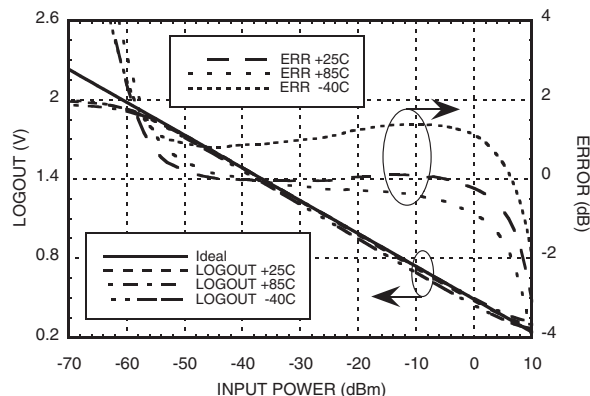

LOGOUT Voltage & Error vs. Input Power, Fin = 1900 MHz

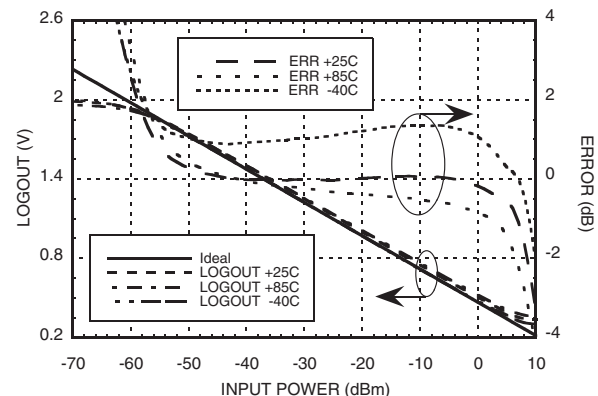

Unless otherwise noted: Vcc1, Vcc2, Vcc3 = +5V, T_A = +25C

Information furnished by Analog Devices is believed to be accurate and reliable. However, no responsibility is assumed by Analog Devices for its use, nor for any infringements of patents or other rights of third parties that may result from its use. Specifications subject to change without notice. No license is granted by implication or otherwise under any patent or patent rights of Analog Devices. Trademarks and registered trademarks are the property of their respective owners.

For price, delivery, and to place orders: Analog Devices, Inc., One Technology Way, P.O. Box 9106, Norwood, MA 02062-9106 Phone: 781-329-4700 • Order online at www.analog.com Application Support: Phone: 1-800-ANALOG-D



70 dB, LOGARITHMIC DETECTOR / CONTROLLER, 1 - 8000 MHz

LOGOUT Voltage & Error vs. Input Power, $f_{in} = 2200$ MHz

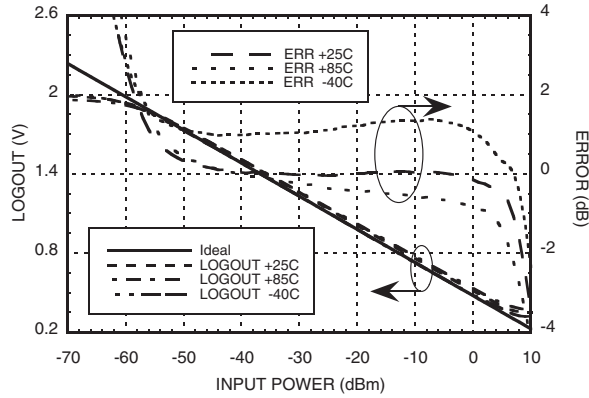

LOGOUT Voltage & Error vs. Input Power, $f_{in} = 3600$ MHz

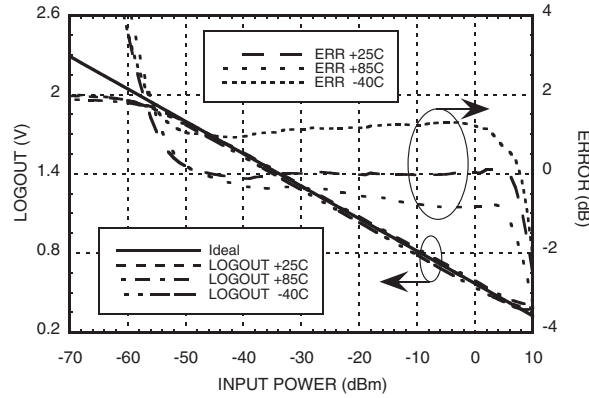

LOGOUT Voltage & Error vs. Input Power, $f_{in} = 5800$ MHz

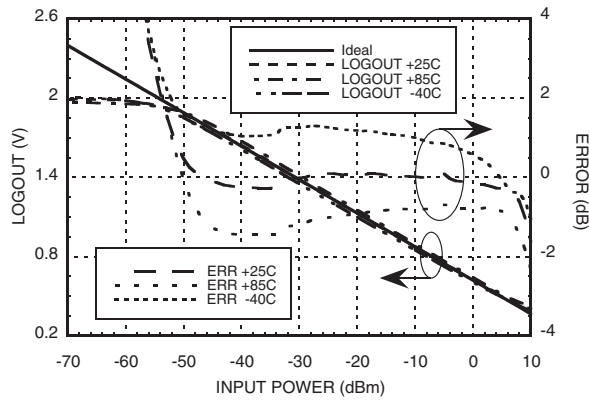

LOGOUT Voltage & Error vs. Input Power, $f_{in} = 7000$ MHz

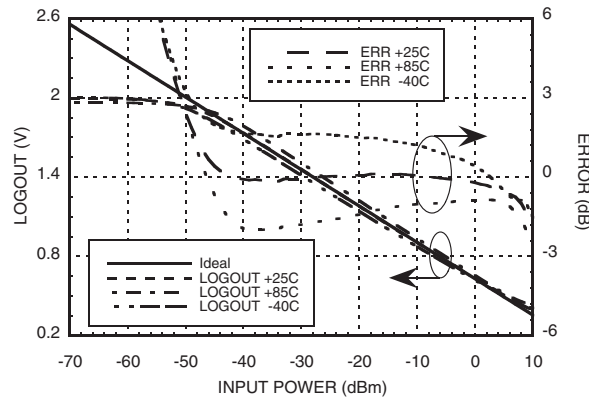

LOGOUT Voltage & Error vs. Input Power, $f_{in} = 8000$ MHz

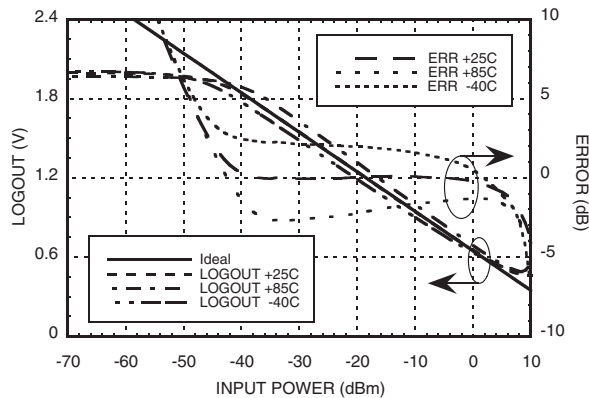

LOGOUT vs. Frequency Over Input Power

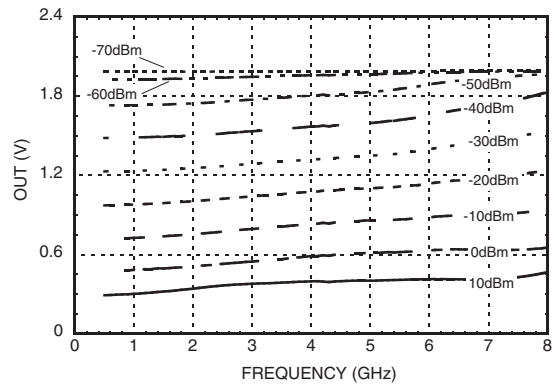

Unless otherwise noted: $V_{cc1}, V_{cc2}, V_{cc3} = +5V, T_A = +25C$

Information furnished by Analog Devices is believed to be accurate and reliable. However, no responsibility is assumed by Analog Devices for its use, nor for any infringements of patents or other rights of third parties that may result from its use. Specifications subject to change without notice. No license is granted by implication or otherwise under any patent or patent rights of Analog Devices. Trademarks and registered trademarks are the property of their respective owners.

For price, delivery, and to place orders: Analog Devices, Inc., One Technology Way, P.O. Box 9106, Norwood, MA 02062-9106 Phone: 781-329-4700 • Order online at www.analog.com Application Support: Phone: 1-800-ANALOG-D

70 dB, LOGARITHMIC DETECTOR / CONTROLLER, 1 - 8000 MHz



LOGOUT Slope vs. Frequency

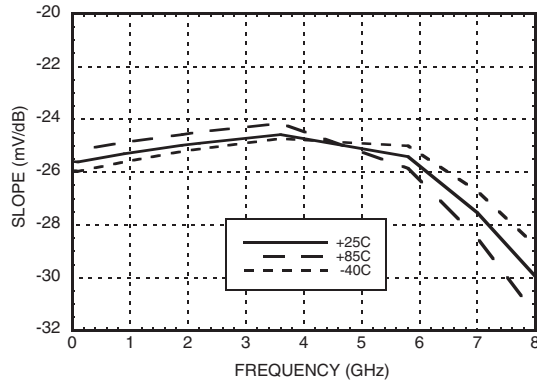

LOGOUT Slope vs. Supply Voltage

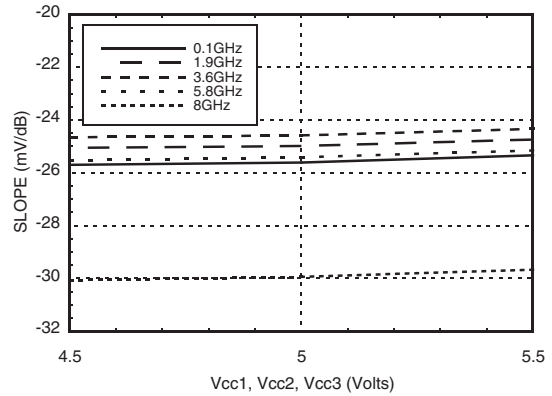

LOGOUT Intercept vs. Frequency

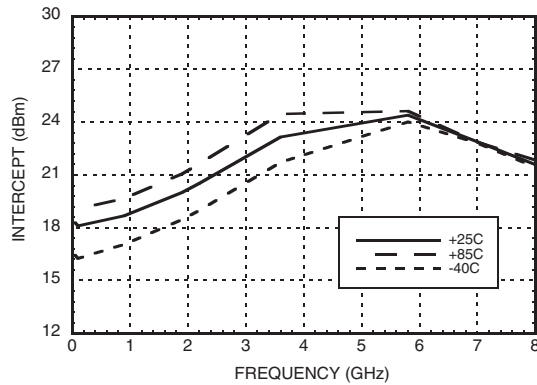

LOGOUT Intercept vs. Supply Voltage

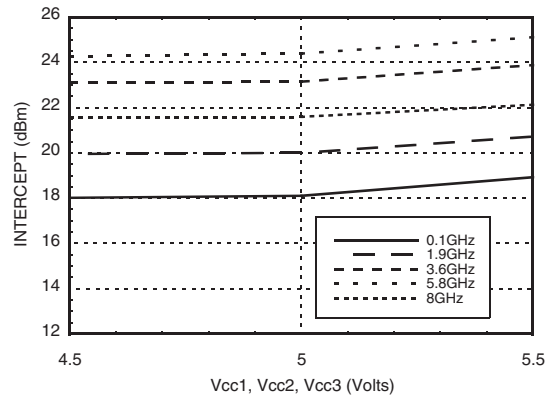

LOGOUT Error vs. Input Power, Normalized [2], Fin= 1900 MHz

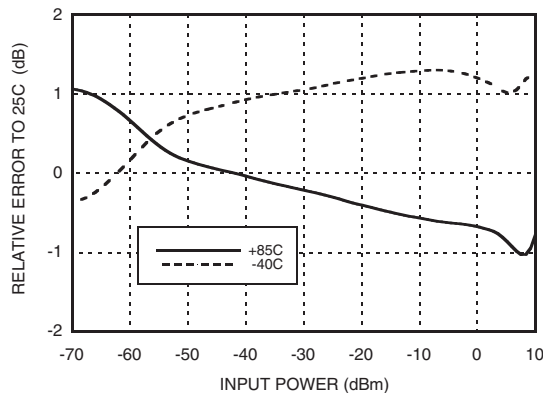

LOGOUT Voltage vs. Input Power & Frequency

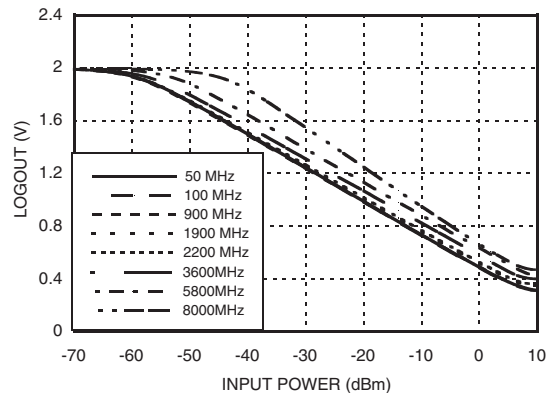

[1] Unless otherwise noted: Vcc1, Vcc2, Vcc3 = +5V, TA = +25C

[2] This data is relative to the room temperature performance of the HMC602LP4(E)

[3] Reference plane at J1 connector on Evaluation PCB

70 dB, LOGARITHMIC DETECTOR / CONTROLLER, 1 - 8000 MHz



Input Return Loss vs Frequency [4]

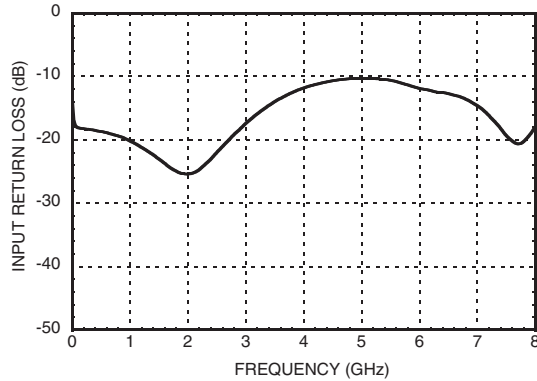

Absolute Maximum Ratings

Vcc1, Vcc2, Vcc3	+5.5V
EN	+5.5V
VSET Input Voltage	+5.5V
LOGOUT Output Current	3 mA
RF Input Power	+15 dBm
Junction Temperature	125 °C
Continuous P _{diss} (T = 85°C) (Derate 7.95 mW/°C above 85°C)	1.55 Watts
Thermal Resistance (R _{th}) (junction to lead)	42 °C/W
Storage Temperature	-65 to +150 °C
Operating Temperature	-40 to +85 °C



**ELECTROSTATIC SENSITIVE DEVICE
OBSERVE HANDLING PRECAUTIONS**

[4] Reference plane at J1 connector on Evaluation PCB

Outline Drawing

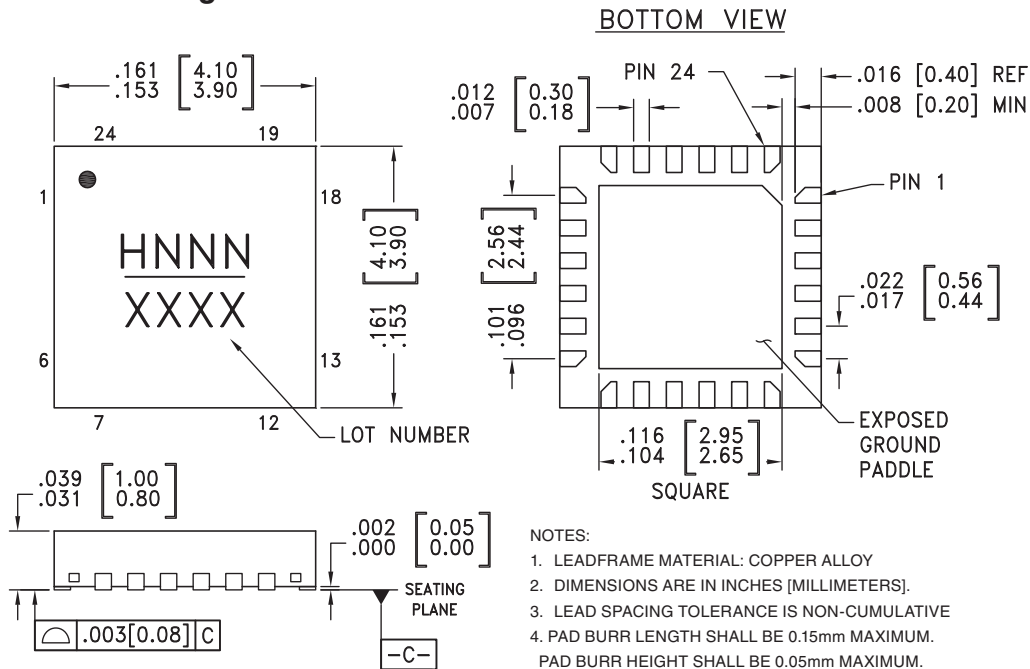

NOTES:

1. LEADFRAME MATERIAL: COPPER ALLOY
2. DIMENSIONS ARE IN INCHES [MILLIMETERS].
3. LEAD SPACING TOLERANCE IS NON-CUMULATIVE
4. PAD BURR LENGTH SHALL BE 0.15mm MAXIMUM.
PAD BURR HEIGHT SHALL BE 0.05mm MAXIMUM.
5. PACKAGE WARP SHALL NOT EXCEED 0.05mm.
6. ALL GROUND LEADS AND GROUND PADDLE MUST BE SOLDERED TO PCB RF GROUND.
7. REFER TO HMC APPLICATION NOTE FOR SUGGESTED PCB LAND PATTERN.

Package Information

Part Number	Package Body Material	Lead Finish	MSL Rating	Package Marking [3]
HMC602LP4	Low Stress Injection Molded Plastic	Sn/Pb Solder	MSL1 [1]	H602 XXXX
HMC602LP4E	RoHS-compliant Low Stress Injection Molded Plastic	100% matte Sn	MSL1 [2]	H602 XXXX

[1] Max peak reflow temperature of 235 °C

[2] Max peak reflow temperature of 260 °C

[3] 4-Digit lot number XXXX

Information furnished by Analog Devices is believed to be accurate and reliable. However, no responsibility is assumed by Analog Devices for its use, nor for any infringements of patents or other rights of third parties that may result from its use. Specifications subject to change without notice. No license is granted by implication or otherwise under any patent or patent rights of Analog Devices. Trademarks and registered trademarks are the property of their respective owners.

For price, delivery, and to place orders: Analog Devices, Inc., One Technology Way, P.O. Box 9106, Norwood, MA 02062-9106
Phone: 781-329-4700 • Order online at www.analog.com
Application Support: Phone: 1-800-ANALOG-D

Pin Descriptions

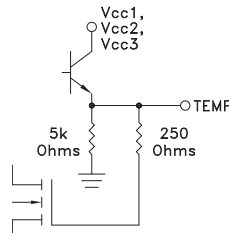
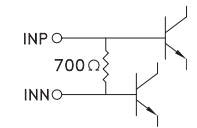
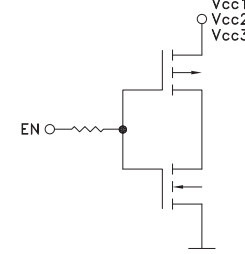
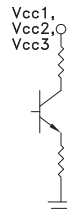
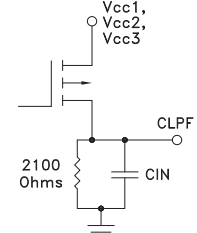
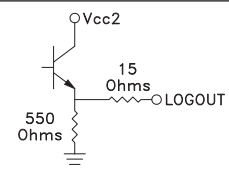
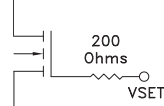
Pin Number	Function	Description	Interface Schematic
1, 6, 7, 13, 17, 18	N/C	These pins are not connected internally.	
2	TEMP	Temperature sensor output pin.	
3, 4	INP, INN	RF Input pins. Connect RF to INP, and AC couple INN to ground for single-ended operation.	
5	EN	Enable pin, connect to Vcc1, Vcc2, Vcc3 for normal operation. Applying voltage $<0.2 \times (V_{cc1}, V_{cc2}, V_{cc3})$ will initiate power saving mode.	
8 - 12, 19, 20, 23, 24	Vcc1, Vcc2, Vcc3	Bias supply. Connect supply voltage to these pins with appropriate filtering.	
14	CLPF	Loop filter capacitor for output ripple filtering.	
15	LOGOUT	Logarithmic output that converts the input power to a DC level in detector mode. Short this pin to VSET for detector mode.	
16	VSET	VSET input in controller mode. Short this pin to LOGOUT for detector mode.	



Pin Descriptions (Continued)

Pin Number	Function	Description	Interface Schematic
21, 22	N/C	The user should not connect to these pins.	
Package Base	GND	Exposed paddle must be connected to RF and DC ground.	

Application & Evaluation PCB Schematic

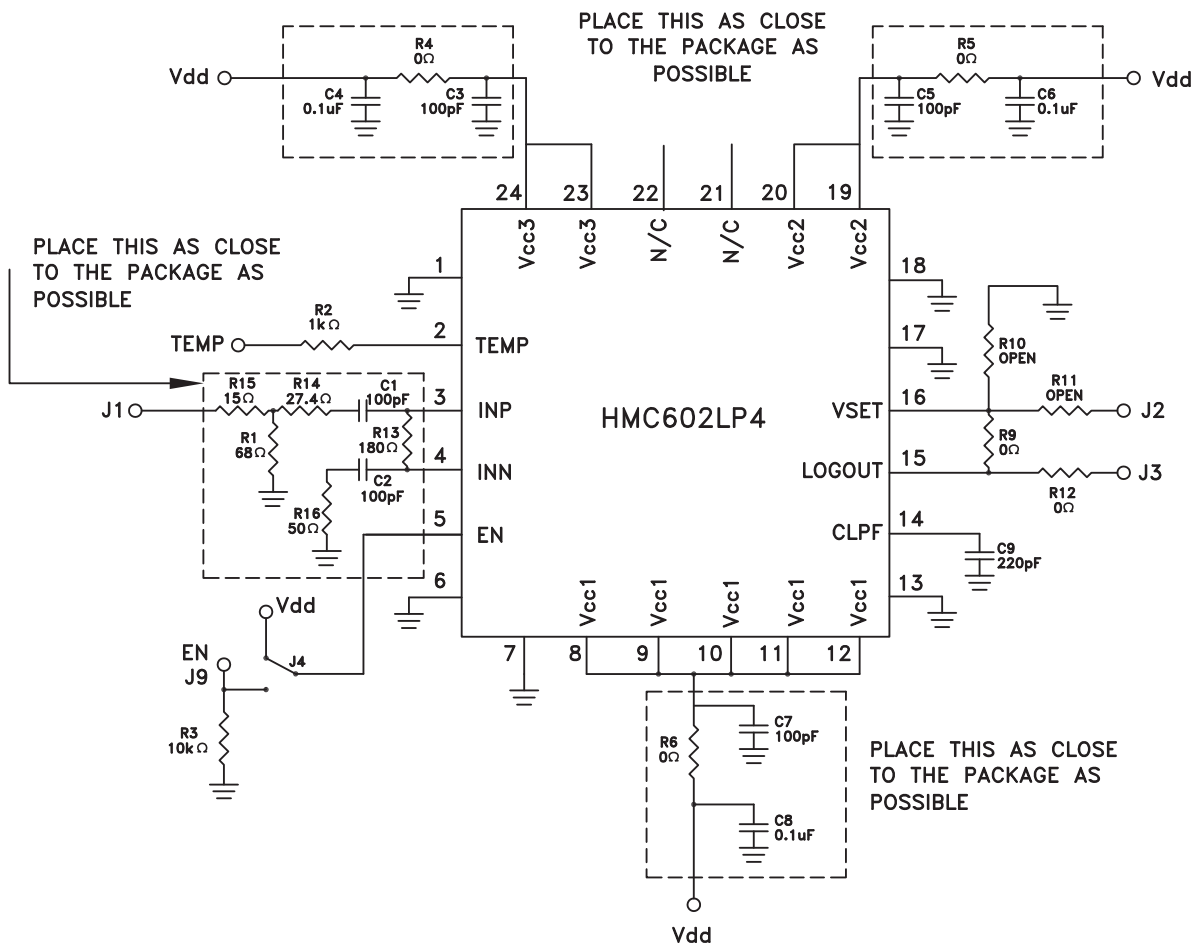

Notes

- Note 1: The HMC602LP4 & HMC602LP4E evaluation boards are pre-assembled for single-ended input, and detector/RSSI mode.
- Note 2: For detector mode, connect high impedance volt meter to the LOGOUT port, and make no connection to VSET. LOGOUT is shorted to VSET by R9, as required for detector mode.
- Note 3: For controller mode, remove R9 and install 0 ohm resistor (R11), then make appropriate connection to LOGOUT and VSET. In controller mode, the LOGOUT output can be used to drive a variable gain amplifier, or a variable attenuator, either directly or through a buffer or microcontroller. VSET should be connected to an external supply, typically between +0.6 and +1.9V.

Information furnished by Analog Devices is believed to be accurate and reliable. However, no responsibility is assumed by Analog Devices for its use, nor for any infringements of patents or other rights of third parties that may result from its use. Specifications subject to change without notice. No license is granted by implication or otherwise under any patent or patent rights of Analog Devices. Trademarks and registered trademarks are the property of their respective owners.

For price, delivery, and to place orders: Analog Devices, Inc., One Technology Way, P.O. Box 9106, Norwood, MA 02062-9106 Phone: 781-329-4700 • Order online at www.analog.com Application Support: Phone: 1-800-ANALOG-D



Evaluation PCB

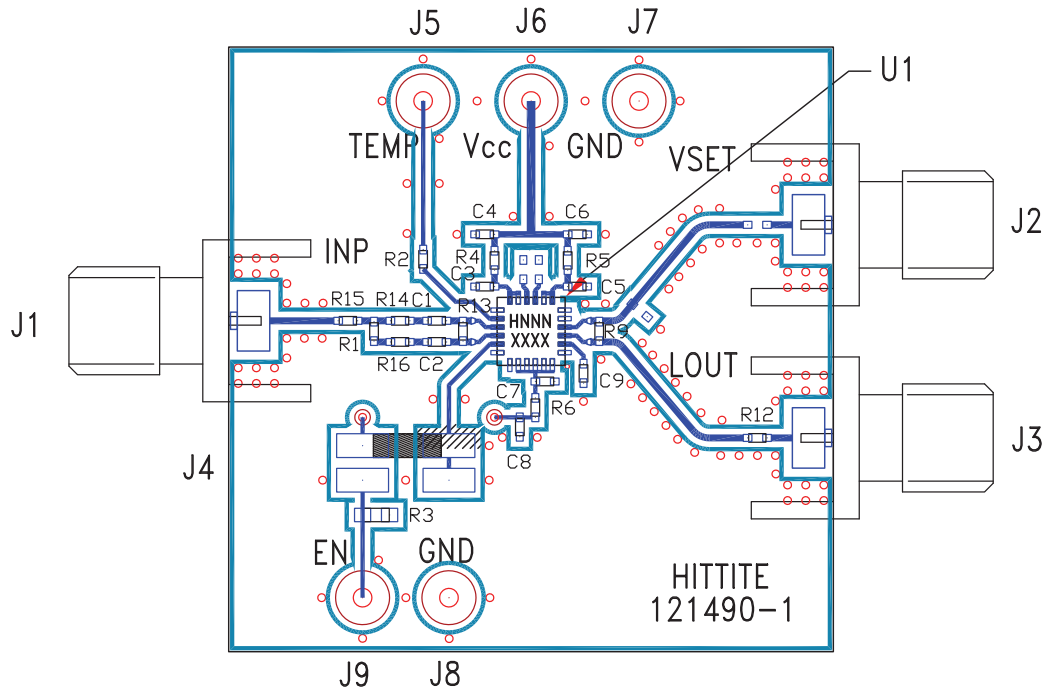

List of Materials for Evaluation PCB 121492 [1]

Item	Description
J1 - J3	PC Mount SMA Connector
J4	Molex Connector Header
J5 - J9	DC Pin
C1, C2, C3, C5, C7	100 pF Capacitor, 0402 Pkg.
C4, C6, C8	0.1µF Capacitor, 0402 Pkg.
C9	220 pF Capacitor, 0402 Pkg.
R1	68Ω Resistor, 0402 Pkg.
R2	1k Ω Resistor, 0402 Pkg.
R3	10k Ω Resistor, 0402 Pkg.
R4 - R6, R9, R12	0Ω Resistor, 0402 Pkg.
R13	180Ω Resistor, 0402 Pkg.
R14	27.4Ω Resistor, 0402 Pkg.
R15	15Ω Resistor, 0402 Pkg.
R16	49.9Ω Resistor, 0402 Pkg.
U1	HMC602LP4 / HMC602LP4E Logarithmic Detector / Controller
PCB [2]	121490 Evaluation PCB

[1] Reference this number when ordering complete evaluation PCB

[2] Circuit Board Material: Rogers 4350

The circuit board used in the final application should use RF circuit design techniques. Signal lines should have 50 ohm impedance while the package ground leads and exposed paddle should be connected directly to the ground plane similar to that shown. A sufficient number of via holes should be used to connect the top and bottom ground planes. The evaluation circuit board shown is available from Hittite upon request.

X-ON Electronics

Largest Supplier of Electrical and Electronic Components

Click to view similar products for [RF Development Tools](#) category:

Click to view products by [Analog Devices](#) manufacturer:

Other Similar products are found below :

[MAAM-011117](#) [MAAP-015036-DIEEV2](#) [EV1HMC1113LP5](#) [EV1HMC6146BLC5A](#) [EV1HMC637ALP5](#) [EVAL-ADG919EBZ](#) [ADL5363-EVALZ](#) [LMV228SDEVAL](#) [SKYA21001-EVB](#) [SMP1331-085-EVB](#) [EV1HMC618ALP3](#) [EVAL01-HMC1041LC4](#) [MAAL-011111-000SMB](#) [MAAM-009633-001SMB](#) [MASW-000936-001SMB](#) [107712-HMC369LP3](#) [107780-HMC322ALP4](#) [SP000416870](#) [EV1HMC470ALP3](#) [EV1HMC520ALC4](#) [EV1HMC244AG16](#) [MAX2614EVKIT#](#) [124694-HMC742ALP5](#) [SC20ASATEA-8GB-STD](#) [MAX2837EVKIT+](#) [MAX2612EVKIT#](#) [MAX2692EVKIT#](#) [EV1HMC629ALP4E](#) [SKY12343-364LF-EVB](#) [108703-HMC452QS16G](#) [EV1HMC863ALC4](#) [119197-HMC658LP2](#) [EV1HMC647ALP6](#) [ADL5725-EVALZ](#) [106815-HMC441LM1](#) [EV1HMC1018ALP4](#) [UXN14M9PE](#) [MAX2016EVKIT](#) [EV1HMC939ALP4](#) [MAX2410EVKIT](#) [MAX2204EVKIT+](#) [EV1HMC8073LP3D](#) [SIMSA868-DKL](#) [SIMSA868C-DKL](#) [SKY65806-636EK1](#) [SKY68020-11EK1](#) [SKY67159-396EK1](#) [SKY66181-11-EK1](#) [SKY65804-696EK1](#) [SKY13396-397LF-EVB](#)