



GaAs MMIC FUNDAMENTAL MIXER, 7 - 34 GHz

Typical Applications

The HMC774LC3B is ideal for:

- Point-to-Point Radios
- Point-to-Multi-Point Radios & VSAT
- Test Equipment & Sensors
- Military End-Use

Features

- Passive: No DC Bias Required
- Input IP3: +22 dBm
- LO/RF Isolation: 35 dB
- Wide IF Bandwidth: DC - 8 GHz
- 12 Lead Ceramic 3x3 mm SMT Package: 9mm²

Functional Diagram

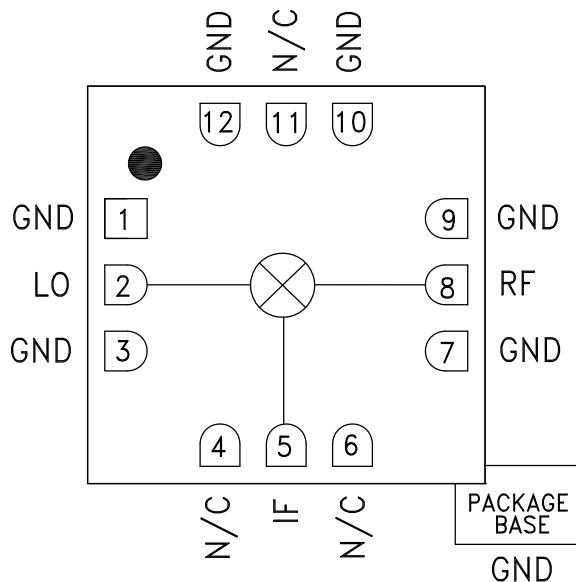

General Description

The HMC774LC3B is a general purpose double balanced mixer in a leadless RoHS compliant SMT package that can be used as an upconverter or downconverter between 7 and 34 GHz. This mixer requires no external components or matching circuitry. The HMC774LC3B provides excellent LO to RF and LO to IF suppression due to optimized balun structures. The mixer operates best with LO drive levels above +15 dBm. The HMC774LC3B eliminates the need for wire bonding, allowing use of surface mount manufacturing techniques.

Electrical Specifications, $T_A = +25^\circ\text{C}$, $IF = 0.5\text{ GHz}$, $LO = +15\text{ dBm}$ *

| Parameter | Min. | Typ. | Max. | Min. | Typ. | Max. | Units |
|-------------------------------|--------|------|---------|------|------|------|-------|
| Frequency Range, RF & LO | 7 - 20 | | 20 - 34 | | | | GHz |
| Frequency Range, IF | DC - 8 | | DC - 8 | | | | GHz |
| Conversion Loss | | 10 | 13 | | 11 | 14 | dB |
| LO to RF Isolation | | 35 | | | 35 | | dB |
| LO to IF Isolation | 20 | 30 | | 25 | 40 | | dB |
| RF to IF Isolation | 7 | 10 | | 14 | 20 | | dB |
| IP3 (Input) | | 20 | | | 22 | | dBm |
| IP2 (Input) | | 45 | | | 48 | | dBm |
| 1 dB Gain Compression (Input) | | 12 | | | 13 | | dBm |

*Unless otherwise noted, all measurements performed as downconverter, $IF = 0.5\text{ GHz}$.



GaAs MMIC FUNDAMENTAL MIXER, 7 - 34 GHz

Conversion Gain vs. Temperature

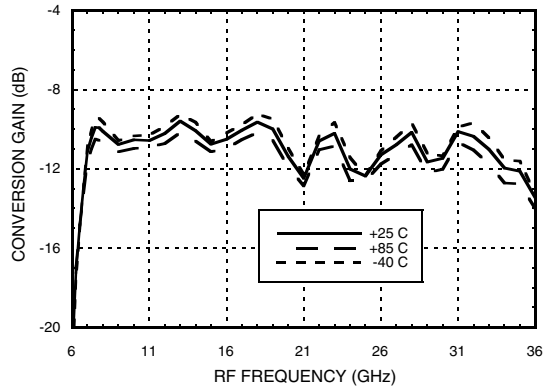

Isolation

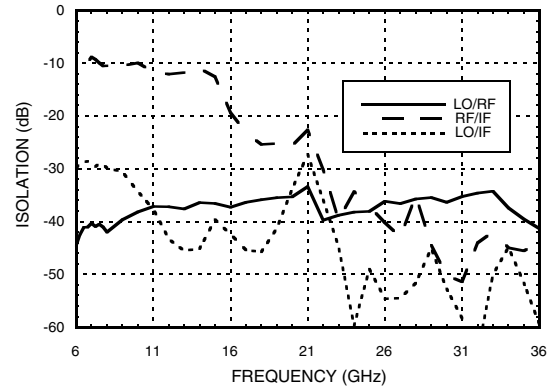

Conversion Gain vs. LO Drive

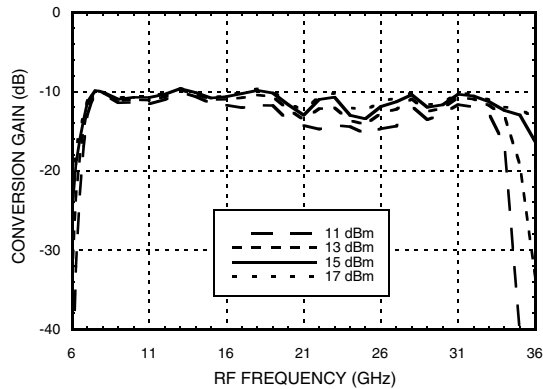

Return Loss

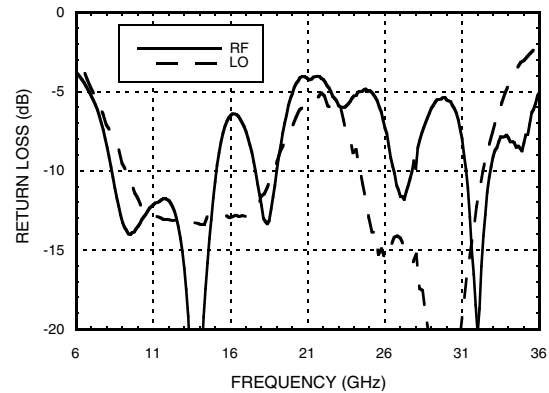

IF Bandwidth

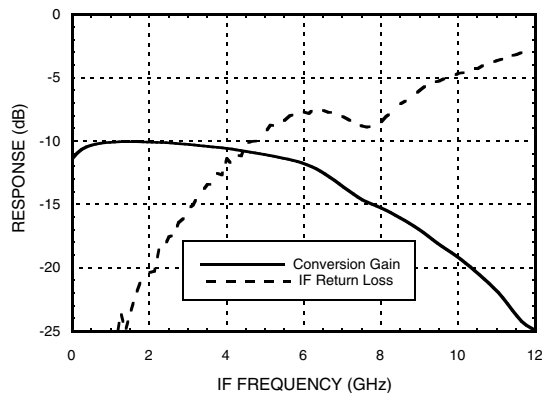

**Upconverter Performance
Conversion Gain vs. LO Drive**

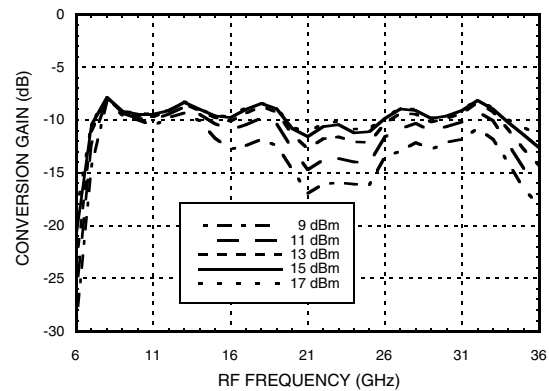

Information furnished by Analog Devices is believed to be accurate and reliable. However, no responsibility is assumed by Analog Devices for its use, nor for any infringements of patents or other rights of third parties that may result from its use. Specifications subject to change without notice. No license is granted by implication or otherwise under any patent or patent rights of Analog Devices. Trademarks and registered trademarks are the property of their respective owners.

For price, delivery, and to place orders: Analog Devices, Inc., One Technology Way, P.O. Box 9106, Norwood, MA 02062-9106 Phone: 781-329-4700 • Order online at www.analog.com Application Support: Phone: 1-800-ANALOG-D



GaAs MMIC FUNDAMENTAL MIXER, 7 - 34 GHz

Input IP3 vs. LO Drive [1]

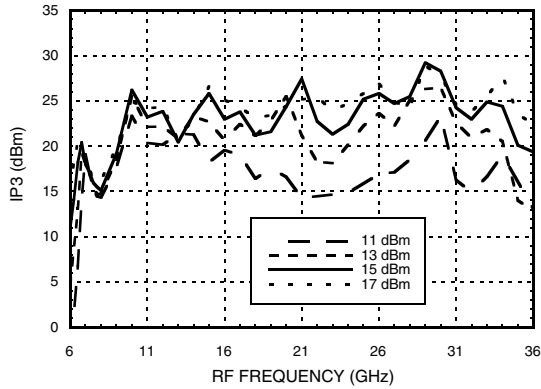

Input IP3 vs. Temperature [1]

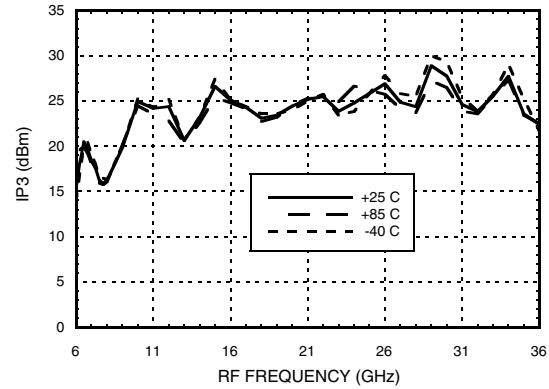

Input IP2 vs. LO Drive [1]

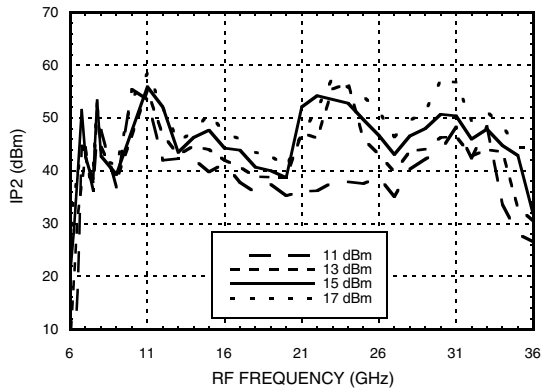

Input IP2 vs. Temperature [1]

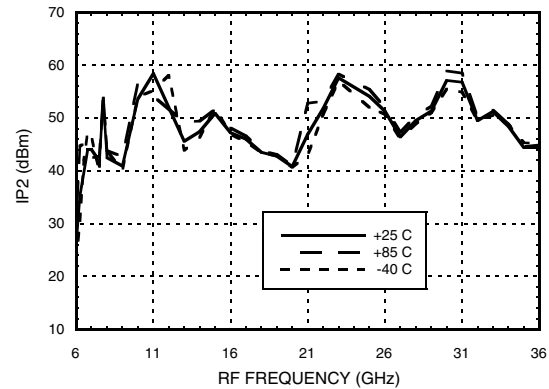

Input P1dB vs. Temperature

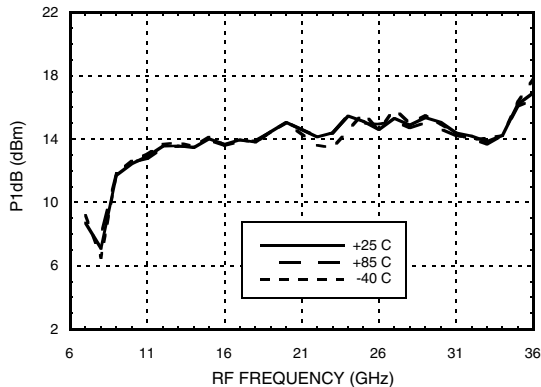

MxN Spurious Outputs

| | | nLO | | | | |
|-----|--|-----|----|----|----|----|
| mRF | | 0 | 1 | 2 | 3 | 4 |
| 0 | | xx | 10 | 39 | xx | xx |
| 1 | | 5 | 0 | 37 | 43 | xx |
| 2 | | 30 | 49 | 47 | 55 | 68 |
| 3 | | xx | 74 | 62 | 45 | 63 |
| 4 | | xx | xx | xx | 77 | 71 |

RF = 17.5 GHz @ -10 dBm
 LO = 18 GHz @ +15 dBm
 All values in dBc below the IF output power level.

[1] Two-tone input power = -10 dBm each tone, 1 MHz spacing.

Information furnished by Analog Devices is believed to be accurate and reliable. However, no responsibility is assumed by Analog Devices for its use, nor for any infringements of patents or other rights of third parties that may result from its use. Specifications subject to change without notice. No license is granted by implication or otherwise under any patent or patent rights of Analog Devices. Trademarks and registered trademarks are the property of their respective owners.

For price, delivery, and to place orders: Analog Devices, Inc., One Technology Way, P.O. Box 9106, Norwood, MA 02062-9106 Phone: 781-329-4700 • Order online at www.analog.com Application Support: Phone: 1-800-ANALOG-D



GaAs MMIC FUNDAMENTAL MIXER, 7 - 34 GHz

Absolute Maximum Ratings

| | |
|---|----------------|
| RF / IF Input | +21 dBm |
| LO Drive | +27 dBm |
| Channel Temperature | 150 °C |
| Continuous Pdiss (Ta = 85 °C) (derate 2.9 mW/°C above 85 °C) | 189 mW |
| Thermal Resistance (channel to ground paddle) | 343 °C/W |
| Storage Temperature | -65 to +150 °C |
| Operating Temperature | -40 to +85 °C |



ELECTROSTATIC SENSITIVE DEVICE
OBSERVE HANDLING PRECAUTIONS

Outline Drawing

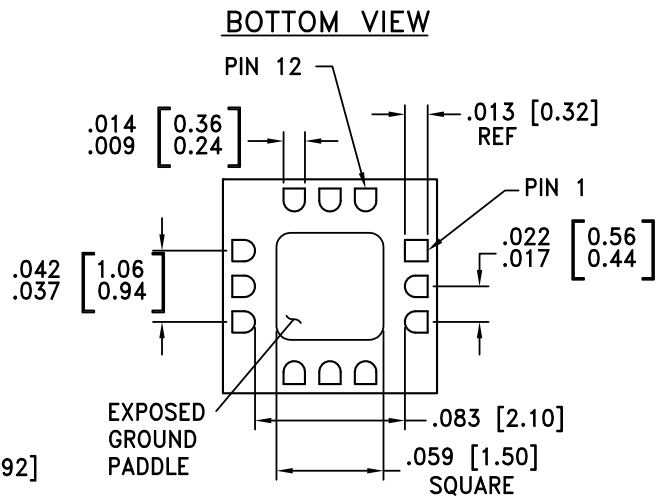
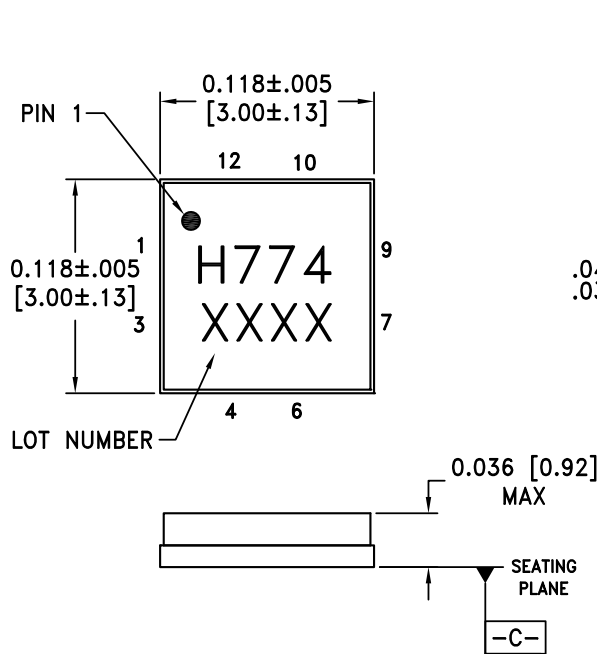

NOTES:

1. PACKAGE BODY MATERIAL: ALUMINA.
2. LEAD AND GROUND PADDLE PLATING: GOLD FLASH OVER NICKEL.
3. DIMENSIONS ARE IN INCHES (MILLIMETERS).
4. LEAD SPACING TOLERANCE IS NON-CUMULATIVE.
5. CHARACTERS TO BE HELVETICA MEDIUM, .025 HIGH, BLACK INK, OR LASER
MARK LOCATED APPROX. AS SHOWN.
6. PACKAGE WARP SHALL NOT EXCEED 0.05MM DATUM - C -
7. ALL GROUND LEADS AND GROUND PADDLE MUST BE SOLDERED TO PCB RF GROUND.

Package Information

| Part Number | Package Body Material | Lead Finish | MSL Rating | Package Marking ^[2] |
|-------------|-----------------------|------------------|---------------------|--------------------------------|
| HMC774LC3B | Alumina, White | Gold over Nickel | MSL3 ^[1] | H774 XXXX |

[1] Max peak reflow temperature of 260 °C

[2] 4-Digit lot number XXXX

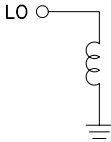
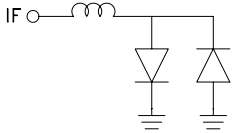
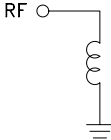

**GaAs MMIC FUNDAMENTAL
MIXER, 7 - 34 GHz**
Pin Descriptions

| Pin Number | Function | Description | Interface Schematic |
|-----------------------|----------|--|--|
| 1, 3, 7, 9, 10, 12 | GND | These pins and package bottom must be connected to RF/DC ground. |  |
| 2 | LO | This pin is DC coupled and matched to 50 Ohms. |  |
| 4, 6, 11 | N/C | These pins are not connected internally; however, all data shown herein was measured with these pins connected to RF/DC ground externally. | |
| 5 | IF | This pin is DC coupled. For applications not requiring operation to DC, this port should be DC blocked externally using a series capacitor whose value has been chosen to pass the necessary IF frequency range. For operation to DC, this pin must not source or sink more than 2 mA of current or part non-function and possible part failure will result. |  |
| 8 | RF | This pin is DC coupled and matched to 50 Ohms. |  |

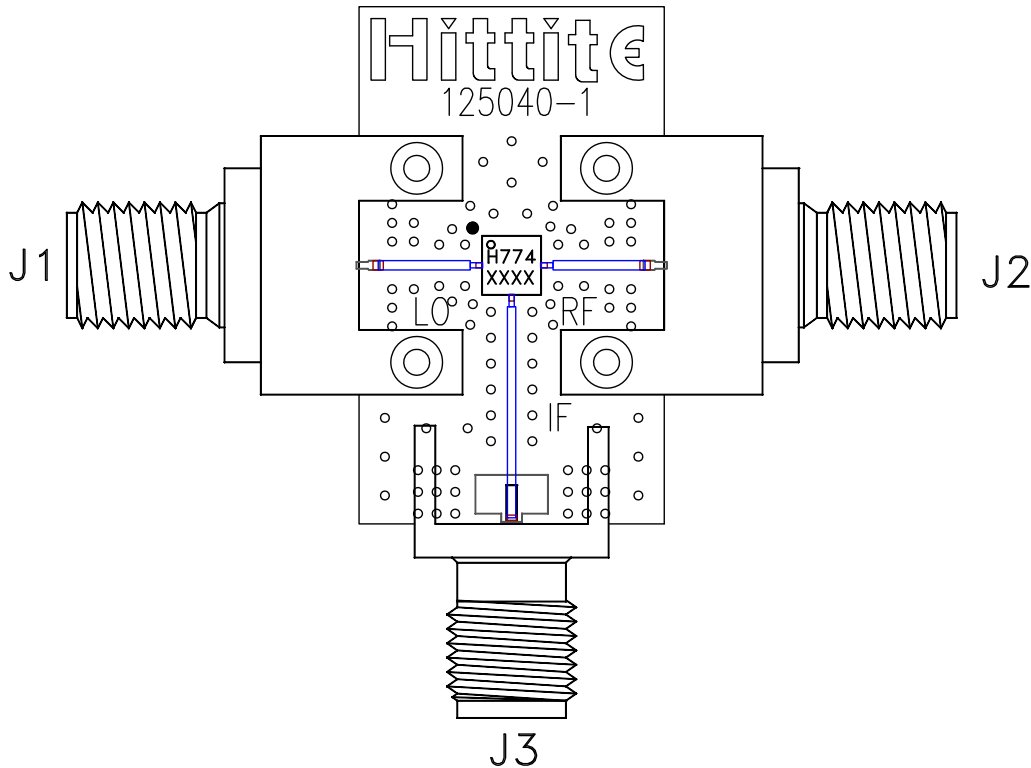

**GaAs MMIC FUNDAMENTAL
MIXER, 7 - 34 GHz**

Evaluation PCB



List of Materials for Evaluation PCB 125042 [1]

| Item | Description |
|---------|-----------------------|
| J1 - J2 | Southwest K Connector |
| J3 | Johnson SMA Connector |
| U1 | HMC774LC3B Mixer |
| PCB [2] | 125040 Evaluation PCB |

[1] Reference this number when ordering complete evaluation PCB

[2] Circuit Board Material: Arlon 25FR or Rogers 4350

The circuit board used in this application should use RF circuit design techniques. Signal lines should have 50 Ohm impedance while the package ground leads and exposed paddle should be connected directly to the ground plane similar to that shown. A sufficient number of via holes should be used to connect the top and bottom ground planes. The evaluation board should be mounted to an appropriate heat sink. The evaluation circuit board shown is available from Hittite upon request.

X-ON Electronics

Largest Supplier of Electrical and Electronic Components

Click to view similar products for [RF Development Tools](#) category:

Click to view products by [Analog Devices](#) manufacturer:

Other Similar products are found below :

[MAAM-011117](#) [MAAP-015036-DIEEV2](#) [EV1HMC1113LP5](#) [EV1HMC6146BLC5A](#) [EV1HMC637ALP5](#) [EVAL-ADG919EBZ](#) [ADL5363-EVALZ](#) [LMV228SDEVAL](#) [SKYA21001-EVB](#) [SMP1331-085-EVB](#) [EV1HMC618ALP3](#) [EVAL01-HMC1041LC4](#) [MAAL-011111-000SMB](#)
[MAAM-009633-001SMB](#) [107712-HMC369LP3](#) [107780-HMC322ALP4](#) [SP000416870](#) [EV1HMC470ALP3](#) [EV1HMC520ALC4](#)
[EV1HMC244AG16](#) [124694-HMC742ALP5](#) [SC20ASATEA-8GB-STD](#) [MAX2837EVKIT+](#) [MAX2612EVKIT#](#) [MAX2692EVKIT#](#)
[SKY12343-364LF-EVB](#) [108703-HMC452QS16G](#) [EV1HMC863ALC4](#) [EV1HMC427ALP3E](#) [119197-HMC658LP2](#) [EV1HMC647ALP6](#)
[ADL5725-EVALZ](#) [106815-HMC441LM1](#) [EV1HMC1018ALP4](#) [UXN14M9PE](#) [MAX2016EVKIT](#) [EV1HMC939ALP4](#) [MAX2410EVKIT](#)
[MAX2204EVKIT+](#) [EV1HMC8073LP3D](#) [SIMSA868-DKL](#) [SIMSA868C-DKL](#) [SKY65806-636EK1](#) [SKY68020-11EK1](#) [SKY67159-396EK1](#)
[SKY66181-11-EK1](#) [SKY65804-696EK1](#) [SKY13396-397LF-EVB](#) [SKY13380-350LF-EVB](#) [SKY13373-460LF-EVB](#)