

FEATURES

- PLL-generated or direct master clock**
- Low EMI design**
- 108 dB DAC/107 dB ADC dynamic range and SNR**
- 94 dB THD + N**
- 3.3 V single supply**
- Tolerance for 5 V logic inputs**
- Supports 24 bits and 8 kHz to 192 kHz sample rates**
- Differential ADC input**
- Single-ended DAC output**
- Log volume control with autoramp function**
- SPI® controllable for flexibility**
- Software-controllable clickless mute**
- Software power-down**
- Right-justified, left-justified, I²S-justified, and TDM modes**
- Master and slave modes up to 16-channel input/output**
- 48-lead LQFP**

APPLICATIONS

- Automotive audio systems**
- Home theater systems**
- Set-top boxes**
- Digital audio effects processors**

GENERAL DESCRIPTION

The AD1928 is a high performance, single-chip codec that provides two analog-to-digital converters (ADCs) with differential input and eight digital-to-analog converters (DACs) with single-ended output using the Analog Devices, Inc., patented multibit sigma-delta (Σ - Δ) architecture. An SPI port is included, allowing a microcontroller to adjust volume and many other parameters. The AD1928 operates from 3.3 V digital and analog supplies. The AD1928 is available in a 48-lead (single-ended output) LQFP package. Other members of this family include a differential DAC output version.

The AD1928 is designed for low EMI. This consideration is apparent in both the system and circuit design architectures. By using the on-board PLL to derive the master clock from the LR clock or from an external crystal, the AD1928 eliminates the need for a separate high frequency master clock and can be used with a suppressed bit clock. The digital-to-analog and analog-to-digital converters are designed using the latest Analog Devices continuous time architectures to further minimize EMI. By using 3.3 V supplies, power consumption is minimized, further reducing emissions.

FUNCTIONAL BLOCK DIAGRAM

Figure 1.

Rev. B

Information furnished by Analog Devices is believed to be accurate and reliable. However, no responsibility is assumed by Analog Devices for its use, nor for any infringements of patents or other rights of third parties that may result from its use. Specifications subject to change without notice. No license is granted by implication or otherwise under any patent or patent rights of Analog Devices. Trademarks and registered trademarks are the property of their respective owners.

TABLE OF CONTENTS

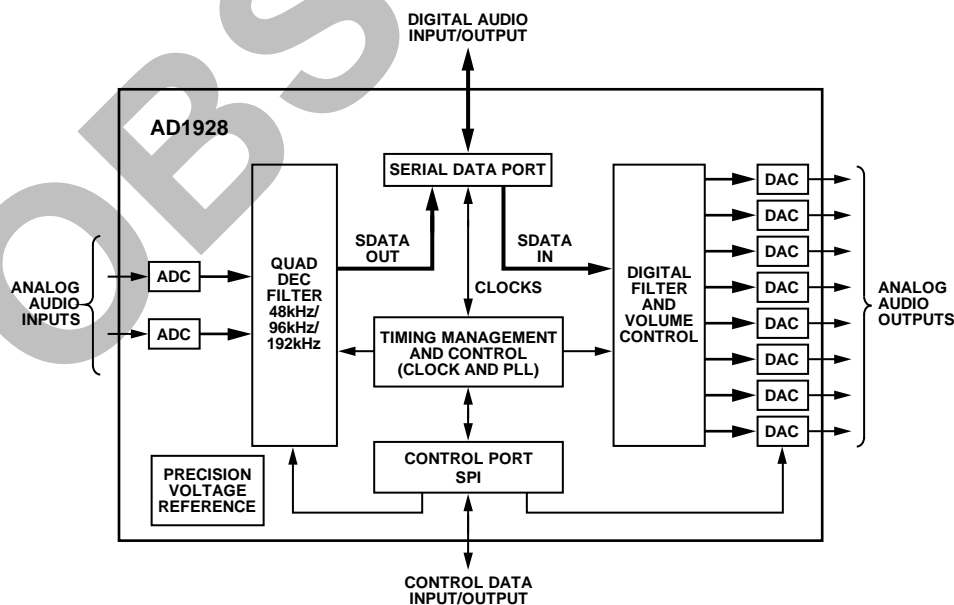
Features	1	Analog-to-Digital Converters (ADCs).....	13
Applications.....	1	Digital-to-Analog Converters (DACs).....	13
General Description	1	Clock Signals.....	13
Functional Block Diagram	1	Reset and Power-Down	14
Revision History	2	Serial Control Port	14
Specifications.....	3	Power Supply and Voltage Reference.....	15
Test Conditions.....	3	Serial Data Ports—Data Format.....	15
Analog Performance Specifications	3	Time-Division Multiplexed (TDM) Modes.....	15
Crystal Oscillator Specifications.....	5	Daisy-Chain Mode	19
Digital Input/Output Specifications.....	5	Control Registers	24
Power Supply Specifications.....	5	Definitions.....	24
Digital Filters.....	6	PLL and Clock Control Registers.....	24
Timing Specifications	6	DAC Control Registers.....	25
Absolute Maximum Ratings.....	8	ADC Control Registers.....	27
Thermal Resistance	8	Additional Modes.....	29
ESD Caution.....	8	Application Circuits	30
Pin Configuration and Function Descriptions.....	9	Outline Dimensions	31
Typical Performance Characteristics	11	Ordering Guide	31
Theory of Operation	13		

REVISION HISTORY

7/11—Rev. A to Rev. B

Deleted References to I ² C	Throughout
Changes to Table 10, DSDATAx/ASDATAx Pin Descriptions...	9

2/11—Rev. 0 to Rev. A

Change to Table 2, Introductory Text	4
Change to Table 4, Introductory Text	5
Change to Table 7, Introductory Text	6
Changes to Figure 29, Figure 31, and Figure 32	30
Changes to Ordering Guide	31

4/07—Revision 0: Initial Version

SPECIFICATIONS

TEST CONDITIONS

Performance of all channels is identical, exclusive of the interchannel gain mismatch and interchannel phase deviation specifications.

Supply voltages (AVDD, DVDD)	3.3 V
Temperature range ¹	As specified in Table 1 and Table 2
Master clock	12.288 MHz (48 kHz f_s , $256 \times f_s$ mode)
Input sample rate	48 kHz
Measurement bandwidth	20 Hz to 20 kHz
Word width	24 bits
Load capacitance (digital output)	20 pF
Load current (digital output)	± 1 mA or $1.5 \text{ k}\Omega$ to $\frac{1}{2}$ DVDD supply
High level input voltage	2.0 V
Low level input voltage	0.8 V

¹ Functionally guaranteed at -40°C to $+125^\circ\text{C}$ case temperature.

ANALOG PERFORMANCE SPECIFICATIONS

Specifications guaranteed at an ambient temperature of 25°C .

Table 1.

Parameter	Conditions	Min	Typ	Max	Unit
ANALOG-TO-DIGITAL CONVERTERS					
ADC Resolution	All ADCs		24		Bits
Dynamic Range	20 Hz to 20 kHz, -60 dB input				
No Filter (RMS)		98	102		dB
With A-Weighted Filter (RMS)		100	105		dB
Total Harmonic Distortion + Noise	-1 dBFS		-96	-87	dB
Full-Scale Input Voltage (Differential)			1.9		V rms
Gain Error		-10		$+10$	%
Interchannel Gain Mismatch		-0.25		$+0.25$	dB
Offset Error		-10	0	$+10$	mV
Gain Drift			100		ppm/ $^\circ\text{C}$
Interchannel Isolation			-110		dB
CMRR	100 mV rms, 1 kHz		55		dB
	100 mV rms, 20 kHz		55		dB
Input Resistance			14		$\text{k}\Omega$
Input Capacitance			10		pF
Input Common-Mode Bias Voltage			1.5		V
DIGITAL-TO-ANALOG CONVERTERS					
Dynamic Range	20 Hz to 20 kHz, -60 dB input				
No Filter (RMS)		98	104		dB
With A-Weighted Filter (RMS)		100	106		dB
With A-Weighted Filter (Average)			108		dB
Total Harmonic Distortion + Noise	0 dBFS				
Single-Ended Version	Two channels running		-92		dB
	Eight channels running		-86	-75	dB
Full-Scale Output Voltage			0.88 (2.48)		V rms (V p-p)
Gain Error		-10		$+10$	%
Interchannel Gain Mismatch		-0.2		$+0.2$	dB
Offset Error		-25	-4	$+25$	mV
Gain Drift		-30		$+30$	ppm/ $^\circ\text{C}$

AD1928

Parameter	Conditions	Min	Typ	Max	Unit
Interchannel Isolation			100		dB
Interchannel Phase Deviation			0		Degrees
Volume Control Step			0.375		dB
Volume Control Range			95		dB
De-emphasis Gain Error				±0.6	dB
Output Resistance at Each Pin			100		Ω
REFERENCE					
Internal Reference Voltage	FILTR pin		1.50		V
External Reference Voltage	FILTR pin	1.32	1.50	1.68	V
Common-Mode Reference Output	CM pin		1.50		V

Specifications measured at a case temperature of 125°C.

Table 2.

Parameter	Conditions	Min	Typ	Max	Unit
ANALOG-TO-DIGITAL CONVERTERS					
ADC Resolution	All ADCs		24		Bits
Dynamic Range	20 Hz to 20 kHz, -60 dB input				
No Filter (RMS)		95	102		dB
With A-Weighted Filter (RMS)		97	105		dB
Total Harmonic Distortion + Noise	-1 dBFS		-96	-87	dB
Full-Scale Input Voltage (Differential)			1.9		V rms
Gain Error		-10		+10	%
Interchannel Gain Mismatch		-0.25		+0.25	dB
Offset Error		-10	0	+10	mV
DIGITAL-TO-ANALOG CONVERTERS					
Dynamic Range	20 Hz to 20 kHz, -60 dB input				
No Filter (RMS)		98	104		dB
With A-Weighted Filter (RMS)		100	106		dB
With A-Weighted Filter (Average)			108		dB
Total Harmonic Distortion + Noise	0 dBFS				
Single-Ended Version	Two channels running		-92		dB
	Eight channels running		-86	-70	dB
Full-Scale Output Voltage			0.8775 (2.482)		V rms (V p-p)
Gain Error		-10		+10	%
Interchannel Gain Mismatch		-0.2		+0.2	dB
Offset Error		-25	-4	+25	mV
Gain Drift		-30		+30	ppm/°C
REFERENCE					
Internal Reference Voltage	FILTR pin		1.50		V
External Reference Voltage	FILTR pin	1.32	1.50	1.68	V
Common-Mode Reference Output	CM pin		1.50		V

CRYSTAL OSCILLATOR SPECIFICATIONS

Table 3.

Parameter	Min	Typ	Max	Unit
Transconductance		3.5		mmhos

DIGITAL INPUT/OUTPUT SPECIFICATIONS

$-40^{\circ}\text{C} < T_{\text{C}} < 125^{\circ}\text{C}$, DVDD = 3.3 V \pm 10%.

Table 4.

Parameter	Conditions/Comments	Min	Typ	Max	Unit
High Level Input Voltage (V_{IH})		2.0			V
	MCLKI/XI pin	2.2			V
Low Level Input Voltage (V_{IL})				0.8	V
Input Leakage	$I_{\text{IH}} @ V_{\text{IH}} = 2.4 \text{ V}$			10	μA
	$I_{\text{IL}} @ V_{\text{IL}} = 0.8 \text{ V}$			10	μA
High Level Output Voltage (V_{OH})	$I_{\text{OH}} = 1 \text{ mA}$	DVDD – 0.60			V
Low Level Output Voltage (V_{OL})	$I_{\text{OL}} = 1 \text{ mA}$			0.4	V
Input Capacitance				5	pF

POWER SUPPLY SPECIFICATIONS

Table 5.

Parameter	Conditions/Comments	Min	Typ	Max	Unit
SUPPLIES					
Voltage	DVDD	3.0	3.3	3.6	V
	AVDD	3.0	3.3	3.6	V
Digital Current	Master clock = 256 f_{s}				
Normal Operation	$f_{\text{s}} = 48 \text{ kHz}$		56		mA
	$f_{\text{s}} = 96 \text{ kHz}$		65		mA
	$f_{\text{s}} = 192 \text{ kHz}$		95		mA
Power-Down	$f_{\text{s}} = 48 \text{ kHz to } 192 \text{ kHz}$		2.0		mA
Analog Current					
Normal Operation			74		mA
Power-Down			23		mA
DISSIPATION					
Normal Operation	Master clock = 256 f_{s} , 48 kHz				
All Supplies			429		mW
Digital Supply			185		mW
Analog Supply			244		mW
Power-Down, All Supplies			83		mW
POWER SUPPLY REJECTION RATIO					
Signal at Analog Supply Pins	1 kHz, 200 mV p-p		50		dB
	20 kHz, 200 mV p-p		50		dB

AD1928

DIGITAL FILTERS

Table 6.

Parameter	Mode	Factor	Min	Typ	Max	Unit
ADC DECIMATION FILTER	All modes, typ @ 48 kHz					
Pass Band		0.4375 f_s		21		kHz
Pass-Band Ripple				± 0.015		dB
Transition Band		0.5 f_s		24		kHz
Stop Band		0.5625 f_s		27		kHz
Stop-Band Attenuation			79			dB
Group Delay		22.9844/ f_s		479		μ s
DAC INTERPOLATION FILTER						
Pass Band	48 kHz mode, typ @ 48 kHz	0.4535 f_s		22		kHz
	96 kHz mode, typ @ 96 kHz	0.3646 f_s	35			kHz
	192 kHz mode, typ @ 192 kHz	0.3646 f_s		70		kHz
Pass-Band Ripple	48 kHz mode, typ @ 48 kHz				± 0.01	dB
	96 kHz mode, typ @ 96 kHz				± 0.05	dB
	192 kHz mode, typ @ 192 kHz				± 0.1	dB
Transition Band	48 kHz mode, typ @ 48 kHz	0.5 f_s		24		kHz
	96 kHz mode, typ @ 96 kHz	0.5 f_s		48		kHz
	192 kHz mode, typ @ 192 kHz	0.5 f_s		96		kHz
Stop Band	48 kHz mode, typ @ 48 kHz	0.5465 f_s		26		kHz
	96 kHz mode, typ @ 96 kHz	0.6354 f_s		61		kHz
	192 kHz mode, typ @ 192 kHz	0.6354 f_s		122		kHz
Stop-Band Attenuation	48 kHz mode, typ @ 48 kHz		70			dB
	96 kHz mode, typ @ 96 kHz		70			dB
	192 kHz mode, typ @ 192 kHz		70			dB
Group Delay	48 kHz mode, typ @ 48 kHz	25/ f_s		521		μ s
	96 kHz mode, typ @ 96 kHz	11/ f_s		115		μ s
	192 kHz mode, typ @ 192 kHz	8/ f_s		42		μ s

TIMING SPECIFICATIONS

$-40^{\circ}\text{C} < T_c < 125^{\circ}\text{C}$, $DVDD = 3.3\text{ V} \pm 10\%$.

Table 7.

Parameter	Condition	Comments	Min	Max	Unit
INPUT MASTER CLOCK (MCLK) AND RESET					
t_{MH}	MCLK duty cycle	DAC/ADC clock source = PLL clock @ 256 f_s , 384 f_s , 512 f_s , and 768 f_s	40	60	%
		DAC/ADC clock source = direct MCLK @ 512 f_s (bypass on-chip PLL)	40	60	%
f_{MCLK}	MCLK frequency	PLL mode, 256 f_s reference	6.9	13.8	MHz
		Direct 512 f_s mode		27.6	MHz
t_{PDR}	$\overline{\text{RST}}$ low		15		ns
t_{PDRR}	$\overline{\text{RST}}$ recovery	Reset to active output	4096		t_{MCLK}
PLL					
Lock Time	MCLK and LR clock input			10	ms
256 f_s VCO Clock Output Duty Cycle	MCLKO/XO pin		40	60	%

Parameter	Condition	Comments	Min	Max	Unit
SPI PORT					
t _{CCH}	CCLK high	See Figure 11, except where otherwise noted	35		ns
t _{CCL}	CCLK low		35		ns
f _{CCLK}	CCLK frequency	f _{CCLK} = 1/t _{CCP} , only t _{CCP} shown in Figure 11		10	MHz
t _{CDS}	CIN setup	To CCLK rising	10		ns
t _{CDH}	CIN hold	From CCLK rising	10		ns
t _{CLS}	CLATCH setup	To CCLK rising	10		ns
t _{CLH}	CLATCH hold	From CCLK falling	10		ns
t _{CLHIGH}	CLATCH high	Not shown in Figure 11	10		ns
t _{COE}	COUT enable	From CCLK falling		30	ns
t _{COD}	COUT delay	From CCLK falling		30	ns
t _{COH}	COUT hold	From CCLK falling, not shown in Figure 11	30		ns
t _{COTS}	COUT tristate	From CCLK falling		30	ns
DAC SERIAL PORT					
t _{DBH}	DBCLK high	See Figure 24 Slave mode	10		ns
t _{DBL}	DBCLK low	Slave mode	10		ns
t _{DLS}	DLRCLK setup	To DBCLK rising, slave mode	10		ns
t _{DLH}	DLRCLK hold	From DBCLK rising, slave mode	5		ns
t _{DLSKEW}	DLRCLK skew	From DBCLK falling, master mode	-8	+8	ns
t _{DDS}	DSDATA setup	To DBCLK rising	10		ns
t _{DDH}	DSDATA hold	From DBCLK rising	5		ns
ADC SERIAL PORT					
t _{ABH}	ABCLK high	See Figure 25 Slave mode	10		ns
t _{ABL}	ABCLK low	Slave mode	10		ns
t _{ALS}	ALRCLK setup	To ABCLK rising, slave mode	10		ns
t _{ALH}	ALRCLK hold	From ABCLK rising, slave mode	5		ns
t _{ALSKEW}	ALRCLK skew	From ABCLK falling, master mode	-8	+8	ns
t _{ABDD}	ASDATA delay	From ABCLK falling		18	ns
AUXILIARY INTERFACE					
t _{AXDS}	AAUXDATA setup	To AUXBCLK rising	10		ns
t _{AXDH}	AAUXDATA hold	From AUXBCLK rising	5		ns
t _{DXDD}	DAUXDATA delay	From AUXBCLK falling		18	ns
t _{XBH}	AUXBCLK high		10		ns
t _{XBL}	AUXBCLK low		10		ns
t _{DLS}	AUXLRCLK setup	To AUXBCLK rising	10		ns
t _{DLH}	AUXLRCLK hold	From AUXBCLK rising	5		ns

ABSOLUTE MAXIMUM RATINGS

Table 8.

Parameter	Rating
Analog (AVDD)	-0.3 V to +3.6 V
Digital (DVDD)	-0.3 V to +3.6 V
Input Current (Except Supply Pins)	±20 mA
Analog Input Voltage (Signal Pins)	-0.3 V to AVDD + 0.3 V
Digital Input Voltage (Signal Pins)	-0.3 V to DVDD + 0.3 V
Operating Temperature Range (Case)	-40°C to +125°C
Storage Temperature Range	-65°C to +150°C

Stresses above those listed under the Absolute Maximum Ratings may cause permanent damage to the device. This is a stress rating only; functional operation of the device at these or any other conditions above those indicated in the operational section of this specification is not implied. Exposure to absolute maximum rating conditions for extended periods may affect device reliability.

THERMAL RESISTANCE

θ_{JA} represents thermal resistance, junction-to-ambient;
 θ_{JC} represents the thermal resistance, junction-to-case. All characteristics are for a 4-layer board.

Table 9. Thermal Resistance

Package Type	θ_{JA}	θ_{JC}	Unit
48-Lead LQFP	50.1	17	°C/W

ESD CAUTION



ESD (electrostatic discharge) sensitive device. Charged devices and circuit boards can discharge without detection. Although this product features patented or proprietary protection circuitry, damage may occur on devices subjected to high energy ESD. Therefore, proper ESD precautions should be taken to avoid performance degradation or loss of functionality.

PIN CONFIGURATION AND FUNCTION DESCRIPTIONS

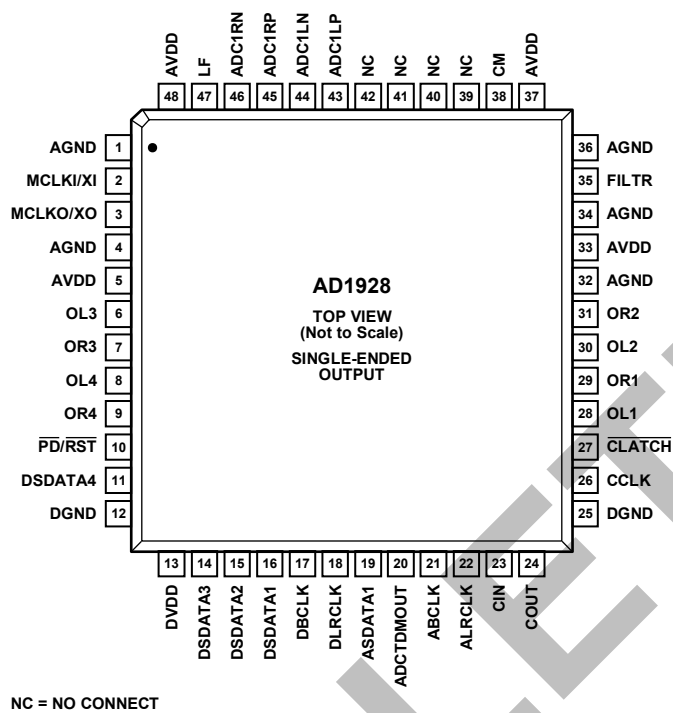

Figure 2. Pin Configuration, 48-Lead LQFP

Table 10. Pin Function Descriptions

Pin No.	Input/Output	Mnemonic	Description
1	I	AGND	Analog Ground.
2	I	MCLKI/XI	Master Clock Input/Crystal Oscillator Input.
3	O	MCLKO/XO	Master Clock Output/Crystal Oscillator Output.
4	I	AGND	Analog Ground.
5	I	AVDD	Analog Power Supply. Connect to analog 3.3 V supply.
6	O	OL3	DAC Left 3 Output.
7	O	OR3	DAC Right 3 Output.
8	O	OL4	DAC Left 4 Output.
9	O	OR4	DAC Right 4 Output.
10	I	$\overline{\text{PD/RST}}$	Power-Down Reset (Active Low).
11	I/O	DSDATA4	DAC Serial Data Input 4. Data input to DAC4 data in/TDM DAC2 data out (dual-line mode)/AUX DAC2 data out (to external DAC2).
12	I	DGND	Digital Ground.
13	I	DVDD	Digital Power Supply. Connect to digital 3.3 V supply.
14	I/O	DSDATA3	DAC Serial Data Input 3. Data input to DAC3 data in/TDM DAC2 data in (dual-line mode)/AUX ADC2 data in (from external ADC2).
15	I/O	DSDATA2	DAC Serial Data Input 2. Data input to DAC2 data in/TDM DAC data out/AUX ADC1 data in (from external ADC1).
16	I	DSDATA1	DAC Serial Data Input 1. Data input to DAC1 data in/TDM DAC data in/TDM data in.
17	I/O	DBCLK	Bit Clock for DACs.
18	I/O	DLRCLK	LR Clock for DACs.
19	I/O	ASDATA1	ADC Serial Data Output 1. Data output from ADC1/TDM ADC data out/TDM data out.
20	O	ADCTDMOUT	ADC TDM Data Output.
21	I/O	ABCLK	Bit Clock for ADCs.
22	I/O	ALRCLK	LR Clock for ADCs.
23	I	CIN	Control Data Input (SPI).
24	I/O	COUT	Control Data Output (SPI).

AD1928

Pin No.	Input/Output	Mnemonic	Description
25	I	DGND	Digital Ground.
26	I	CCLK	Control Clock Input (SPI).
27	I	CLATCH	Latch Input for Control Data (SPI).
28	O	OL1	DAC Left 1 Output.
29	O	OR1	DAC Right 1 Output.
30	O	OL2	DAC Left 2 Output.
31	O	OR2	DAC Right 2 Output.
32	I	AGND	Analog Ground.
33	I	AVDD	Analog Power Supply. Connect to analog 3.3 V supply.
34	I	AGND	Analog Ground.
35	O	FILTR	Voltage Reference Filter Capacitor Connection. Bypass with 10 μ F 100 nF to AGND.
36	I	AGND	Analog Ground.
37	I	AVDD	Analog Power Supply. Connect to analog 3.3 V supply.
38	O	CM	Common-Mode Reference Filter Capacitor Connection. Bypass with 47 μ F 100 nF to AGND.
39 to 42	I	Unused	Must be tied to common mode, Pin 38; alternatively, ac-coupled to ground.
43	I	ADC1LP	ADC Left 1 Positive Input.
44	I	ADC1LN	ADC Left 1 Negative Input.
45	I	ADC1RP	ADC Right 1 Positive Input.
46	I	ADC1RN	ADC Right 1 Negative Input.
47	O	LF	PLL Loop Filter. Return to AVDD.
48	I	AVDD	Analog Power Supply. Connect to analog 3.3 V supply.

TYPICAL PERFORMANCE CHARACTERISTICS

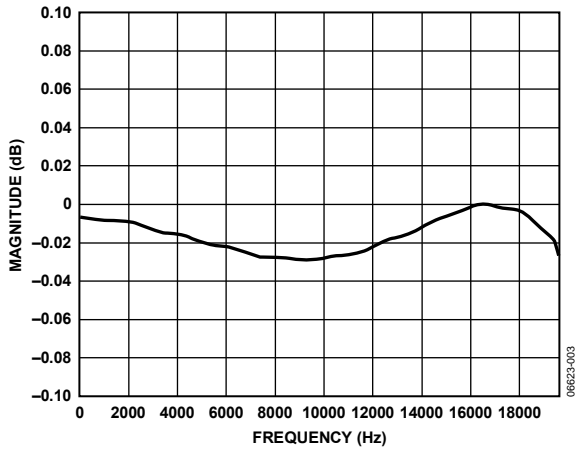

Figure 3. ADC Pass-Band Filter Response, 48 kHz

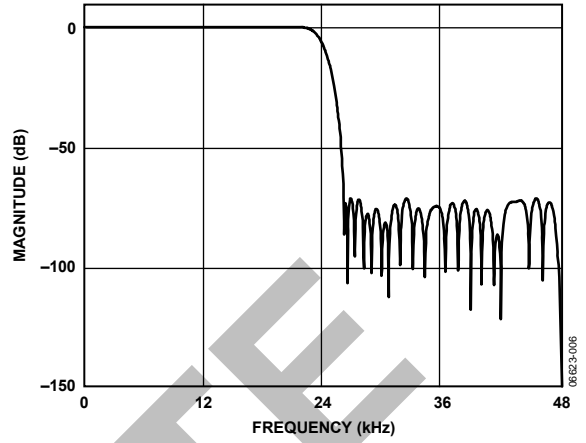

Figure 6. DAC Stop-Band Filter Response, 48 kHz

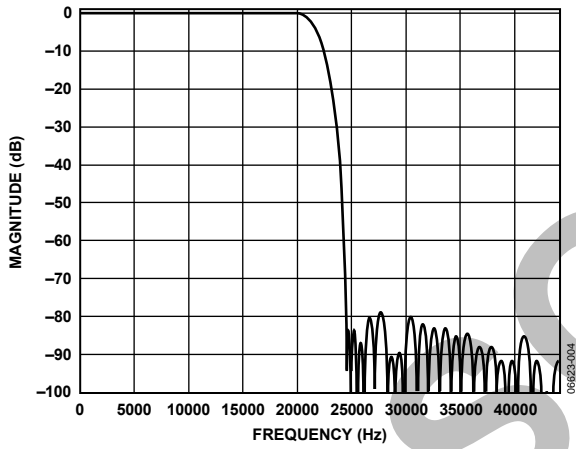

Figure 4. ADC Stop-Band Filter Response, 48 kHz

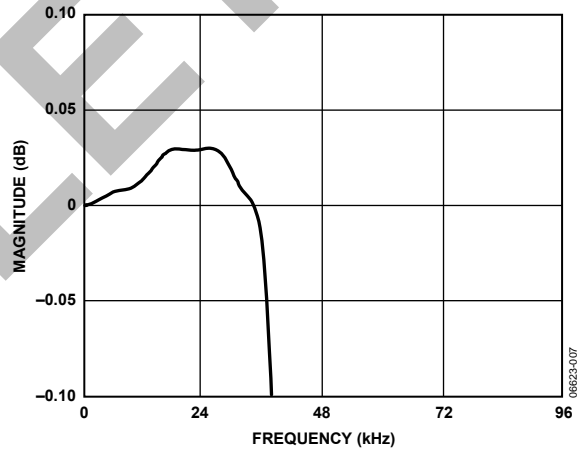

Figure 7. DAC Pass-Band Filter Response, 96 kHz

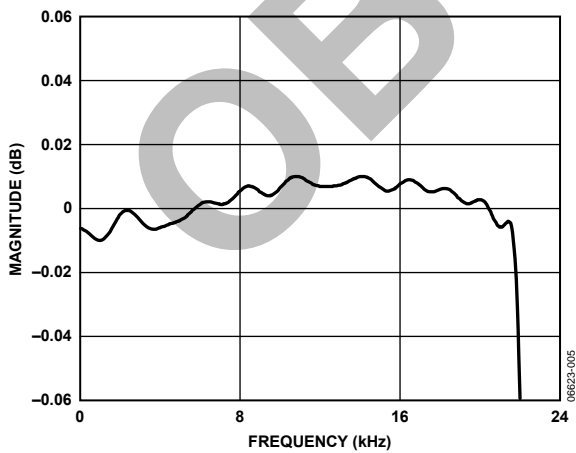

Figure 5. DAC Pass-Band Filter Response, 48 kHz

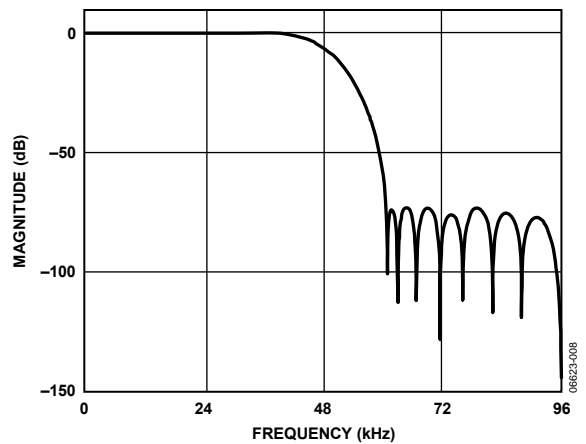

Figure 8. DAC Stop-Band Filter Response, 96 kHz

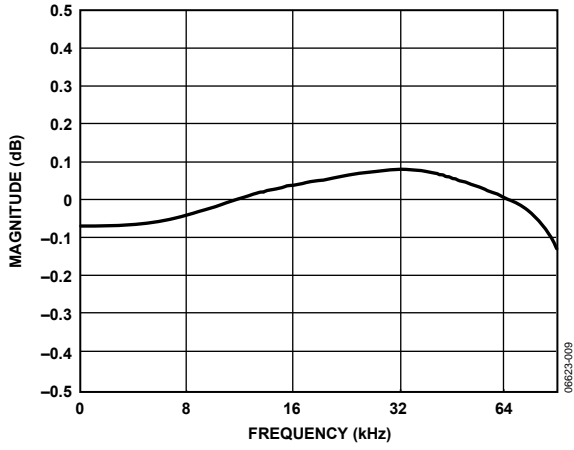

Figure 9. DAC Pass-Band Filter Response, 192 kHz

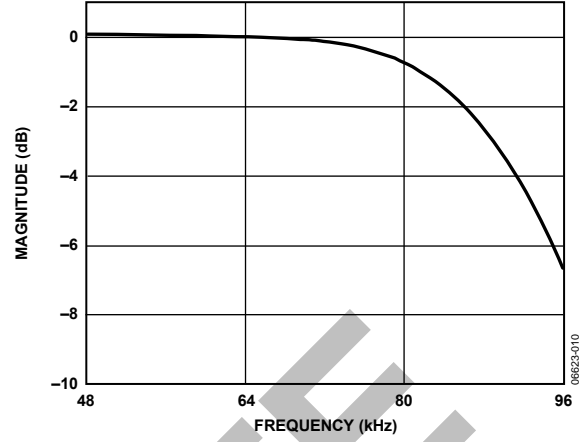

Figure 10. DAC Stop-Band Filter Response, 192 kHz

OBSOLETE

THEORY OF OPERATION

ANALOG-TO-DIGITAL CONVERTERS (ADCS)

There are two analog-to-digital converter (ADC) channels in the AD1928, configured as a stereo pair with differential inputs. The ADCs can operate at a nominal sample rate of 48 kHz, 96 kHz, or 192 kHz. The ADCs include on-board digital antialiasing filters with 79 dB stop-band attenuation and linear phase response, operating at an oversampling ratio of 128 (48 kHz, 96 kHz, and 192 kHz modes). Digital outputs are supplied through two serial data output pins (one for each stereo pair) and a common frame clock (ALRCLK) and bit clock (ABCLK). Alternatively, one of the TDM modes can be used to access up to 14 channels on a single TDM data line.

The ADCs must be driven from a differential signal source for best performance. The input pins of the ADCs connect to internal switched capacitors. To isolate the external driving op amp from the glitches caused by the internal switched capacitors, each input pin should be isolated by using a series-connected, external, 100 Ω resistor together with a 1 nF capacitor connected from each input to ground. This capacitor must be of high quality, for example, ceramic NP0 or polypropylene film.

The differential inputs have a nominal common-mode voltage of 1.5 V. The voltage at the common-mode reference pin (CM) can be used to bias external op amps to buffer the input signals (see the Power Supply and Voltage Reference section). The inputs can also be ac-coupled and do not need an external dc bias to CM.

A digital high-pass filter can be switched in line with the ADCs under serial control to remove residual dc offsets. It has a 1.4 Hz, 6 dB per octave cutoff at a 48 kHz sample rate. The cutoff frequency scales directly with sample frequency.

DIGITAL-TO-ANALOG CONVERTERS (DACs)

The AD1928 digital-to-analog converter (DAC) channels are arranged as four single-ended stereo pairs, providing eight analog outputs for minimum external components. The DACs include on-board digital reconstruction filters with 70 dB stop-band attenuation and linear phase response, operating at an oversampling ratio of 4 (48 kHz or 96 kHz modes) or 2 (192 kHz mode). Each channel has its own independently programmable attenuator, adjustable in 255 steps in 0.375 dB increments. Digital inputs are supplied through four serial data input pins (one for each stereo pair) and a common frame clock (DLRCLK) and bit clock (DBCLK). Alternatively, one of the TDM modes can be used to access up to 16 channels on a single TDM data line.

Each output pin has a nominal common-mode dc level of 1.5 V and swings ± 1.27 V for a 0 dBFS digital input signal. A single op amp, third-order, external, low-pass filter is recommended to remove high frequency noise present on the output pins. The use of op amps with low slew rate or low bandwidth can cause high frequency noise and tones to fold down into the audio band; therefore, exercise care in selecting these components.

The voltage at CM, the common-mode reference pin, can be used to bias the external op amps that buffer the output signals (see the Power Supply and Voltage Reference section).

CLOCK SIGNALS

The on-chip phase-locked loop (PLL) can be selected to reference the input sample rate from either of the LRCLK pins or 256, 384, 512, or 768 times the sample rate, referenced to the 48 kHz mode from the MCLKI/XI pin. The default at power-up is $256 \times f_s$ from MCLKI/XI. In 96 kHz mode, the master clock frequency stays at the same absolute frequency; therefore, the actual multiplication rate is divided by 2. In 192 kHz mode, the actual multiplication rate is divided by 4. For example, if the AD1928 is programmed in $256 \times f_s$ mode, the frequency of the master clock input is 256×48 kHz = 12.288 MHz. If the AD1928 is then switched to 96 kHz operation (by writing to the SPI port), the frequency of the master clock should remain at 12.288 MHz, which, under these conditions, is $128 \times f_s$. In 192 kHz mode, this becomes $64 \times f_s$.

The internal clock for the ADCs is $256 \times f_s$ for all clock modes. The internal clock for the DACs varies by mode: $512 \times f_s$ (48 kHz mode), $256 \times f_s$ (96 kHz mode), or $128 \times f_s$ (192 kHz mode). By default, the on-board PLL generates this internal master clock from an external clock. A direct $512 \times f_s$ (referenced to 48 kHz mode) master clock can be used for either the ADCs or DACs if selected in the PLL and Clock Control 1 register.

Note that it is not possible to use a direct clock for the ADCs set to the 192 kHz mode. It is required that the on-chip PLL be used in this mode.

The PLL can be powered down in the PLL and Clock Control 0 register. To ensure reliable locking when changing PLL modes, or if the reference clock is unstable at power-on, power down the PLL and then power it back up when the reference clock has stabilized.

The internal master clock (MCLK) can be disabled in the PLL and Clock Control 0 register to reduce power dissipation when the AD1928 is idle. The clock should be stable before it is enabled. Unless a standalone mode is selected (see the Serial Control Port section), the clock is disabled by reset and must be enabled by writing to the SPI port for normal operation.

To maintain the highest performance possible, it is recommended that the clock jitter of the internal master clock signal be limited to less than 300 ps rms TIE (time interval error). Even at these levels, extra noise or tones can appear in the DAC outputs if the jitter spectrum contains large spectral peaks. If the internal PLL is not being used, it is best to use an independent crystal oscillator to generate the master clock. In addition, it is especially important that the clock signal should not be passed through an FPGA, CPLD, or other large digital chip (such as a DSP) before being applied to the AD1928. In most cases, this induces clock jitter due to the sharing of common power and

AD1928

ground connections with other unrelated digital output signals. When the PLL is used, jitter in the reference clock is attenuated above a certain frequency depending on the loop filter.

RESET AND POWER-DOWN

The function of the $\overline{\text{RST}}$ pin sets all the control registers to their default settings. To avoid pops, reset does not power down the analog outputs. After $\overline{\text{RST}}$ is deasserted and the PLL acquires lock condition, an initialization routine runs inside the AD1928. This initialization lasts for approximately 256 master clock cycles.

The power-down bits in the PLL and Clock Control 0, DAC Control 1, and ADC Control 1 registers power down the respective sections. All other register settings are retained. The reset pin, $\overline{\text{PD/RST}}$, should be pulled low by an external resistor to guarantee proper startup.

SERIAL CONTROL PORT

The AD1928 has an SPI control port that permits programming and reading back of the internal control registers for the ADCs, DACs, and clock system. There is also a standalone mode

available for operation without serial control that is configured at reset using the serial control pins. All registers are set to default, except the internal master clock enable is set to 1 and ADC BCLK and LRCLK master/slave is set by the COUT pin. Standalone mode only supports stereo mode with an I²S data format and 256 f_s master clock rate. Refer to Table 11 for details. It is recommended to use a weak pull-up resistor on $\overline{\text{CLATCH}}$ in applications that have a microcontroller. This pull-up resistor ensures that the AD1928 recognizes the presence of a microcontroller.

The SPI control port of the AD1928 is a 4-wire serial control port. The format is similar to the Motorola® SPI format, except the input data-word is 24 bits wide. The serial bit clock and latch can be completely asynchronous to the sample rate of the ADCs and DACs. Figure 11 shows the format of the SPI signal. The first byte is a global address with a read/write bit. For the AD1928, the address is 0x04, shifted left 1 bit due to the R/W bit. The second byte is the AD1928 register address and the third byte is the data.

Table 11. Standalone Mode Selection

ADC Clocks	CIN	COUT	CCLK	CLATCH
Slave	0	0	0	0
Master	0	1	0	0

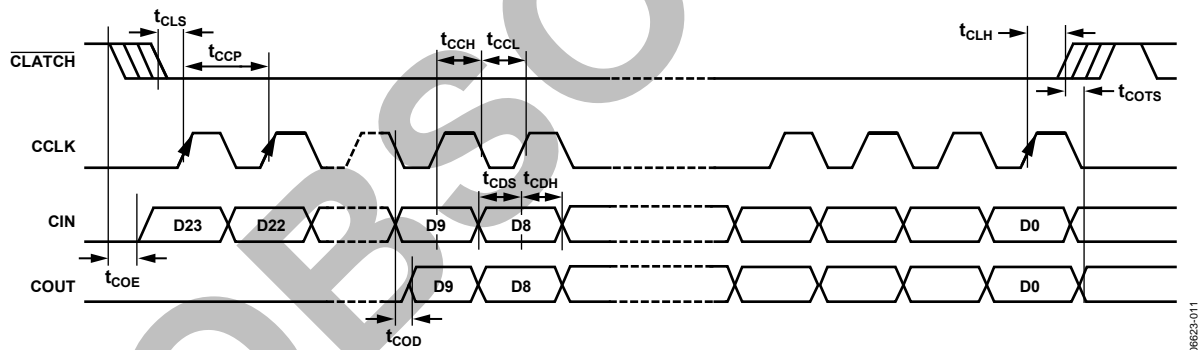

Figure 11. Format of SPI Signal

09623-011

POWER SUPPLY AND VOLTAGE REFERENCE

The AD1928 is designed for 3.3 V supplies. Separate power supply pins are provided for the analog and digital sections. These pins should be bypassed with 100 nF ceramic chip capacitors, as close to the pins as possible, to minimize noise pickup. A bulk aluminum electrolytic capacitor of at least 22 μ F should also be provided on the same PC board as the codec. For critical applications, improved performance is obtained with separate supplies for the analog and digital sections. If this is not possible, it is recommended that the analog and digital supplies be isolated by means of a ferrite bead in series with each supply. It is important that the analog supply be as clean as possible.

All digital inputs are compatible with TTL and CMOS levels. All outputs are driven from the 3.3 V DVDD supply and are compatible with TTL and 3.3 V CMOS levels.

The ADC and DAC internal voltage reference (V_{REF}) is brought out on FILTR and should be bypassed as close as possible to the chip, with a parallel combination of 10 μ F and 100 nF. Any external current drawn should be limited to less than 50 μ A.

The internal reference can be disabled in the PLL and Clock Control 1 register, and FILTR can be driven from an external source. This can be used to scale the DAC output to the clipping level of a power amplifier based on its power supply voltage. The ADC input gain varies by the inverse ratio. The total gain from ADC input to DAC output remains constant.

The CM pin is the internal common-mode reference. It should be bypassed as close as possible to the chip, with a parallel combination of 47 μ F and 100 nF. This voltage can be used to bias external op amps to the common-mode voltage of the input and output signal pins. The output current should be limited to less than 0.5 mA source and 2 mA sink.

SERIAL DATA PORTS—DATA FORMAT

The eight DAC channels use a common serial bit clock (DBCLK) and a common left-right framing clock (DLRCLK) in the serial data port. The two ADC channels use a common serial bit clock (ABCLK) and left-right framing clock (ALRCLK) in the serial data port. The clock signals are all synchronous with the sample rate. The normal stereo serial modes are shown in Figure 23.

The ADC and DAC serial data modes default to I²S. The ports can also be programmed for left-justified, right-justified, and TDM modes. The word width is 24 bits by default and can be programmed for 16 or 20 bits. The DAC serial formats are programmable according to DAC Control 0 register. The polarity of the DBCLK and DLRCLK is programmable according to the DAC Control 1 register. The ADC serial formats and serial clock polarity are programmable according to ADC Control 1 register. Both DAC and ADC serial ports are programmable to become the bus masters according to the DAC Control 1 register and the ADC Control 2 register. By default, both ADC and DAC serial ports are in slave mode.

TIME-DIVISION MULTIPLEXED (TDM) MODES

The AD1928 serial ports also have several different TDM serial data modes. The first and most commonly used configurations are shown in Figure 12 and Figure 13. In Figure 12, the ADC serial port outputs one data stream consisting of two on-chip ADCs and unused slots. In Figure 13, the eight on-chip DAC data slots are packed into one TDM stream. In this mode, both DBCLK and ABCLK are 256 fs.

The input/output pins of the serial ports are defined according to the serial mode selected. For a detailed description of the function of each pin in TDM and auxiliary modes, see Table 12.

The AD1928 allows systems with more than eight DAC channels to be easily configured by the use of an auxiliary serial data port. The DAC TDM-AUX mode is shown in Figure 14. In this mode, the AUX channels are the last four slots of the TDM data stream. These slots are extracted and output to the AUX serial port. Note that due to the high DBCLK frequency, this mode is available only in the 48 kHz/44.1 kHz/32 kHz sample rate.

The AD1928 also allows system configurations with more than two ADC channels, as shown in Figure 15 and Figure 16, which show configurations using 6 ADCs and 14 ADCs, respectively. Again, due to the high ABCLK frequency, this mode is available only in the 48 kHz/44.1 kHz/32 kHz sample rate.

Combining the AUX ADC and DAC modes results in a system configuration of 6 ADCs and 12 DACs. The system, then, consists of two external stereo ADCs, two external stereo DACs, and one AD1928. This mode is shown in Figure 17 (combined AUX DAC and ADC modes).

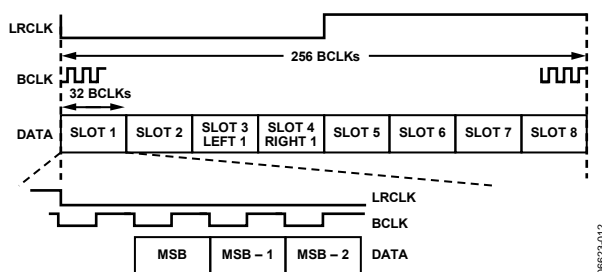

Figure 12. ADC TDM (6-Channel I²S Mode)

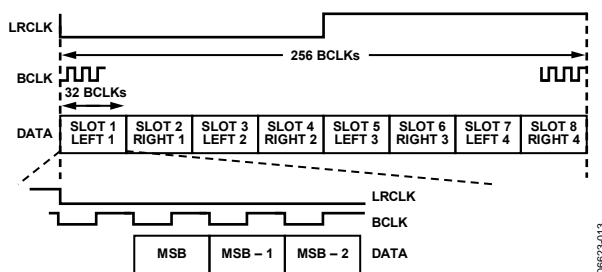

Figure 13. DAC TDM (8-Channel I²S Mode)

AD1928

Table 12. Pin Function Changes in TDM-AUX Mode

Mnemonic	Stereo Modes	TDM Modes	AUX Modes
ADCTDMOUT	NC	ADC TDM Data Output	TDM Data Output
ASDATA1	ADC1 Data Output	ADC TDM Data Input	AUX Data Output 1 (to External DAC 1)
DSDATA1	DAC1 Data Input	DAC TDM Data Input	TDM Data Input
DSDATA2	DAC2 Data Input	DAC TDM Data Output	AUX Data Input 1 (from External ADC 1)
DSDATA3	DAC3 Data Input	DAC TDM Data Input 2 (Dual-Line Mode)	AUX Data Input 2 (from External ADC 2)
DSDATA4	DAC4 Data Input	DAC TDM Data Output 2 (Dual-Line Mode)	AUX Data Output 2 (to External DAC 2)
ALRCLK	ADC LRCLK Input/Output	ADC TDM Frame Sync Input/Output	TDM Frame Sync Input/Output
ABCLK	ADC BCLK Input/Output	ADC TDM BCLK Input/Output	TDM BCLK Input/Output
DLRCLK	DAC LRCLK Input/Output	DAC TDM Frame Sync Input/Output	AUX LRCLK Input/Output
DBCLK	DAC BCLK Input/Output	DAC TDM BCLK Input/Output	AUX BCLK Input/Output

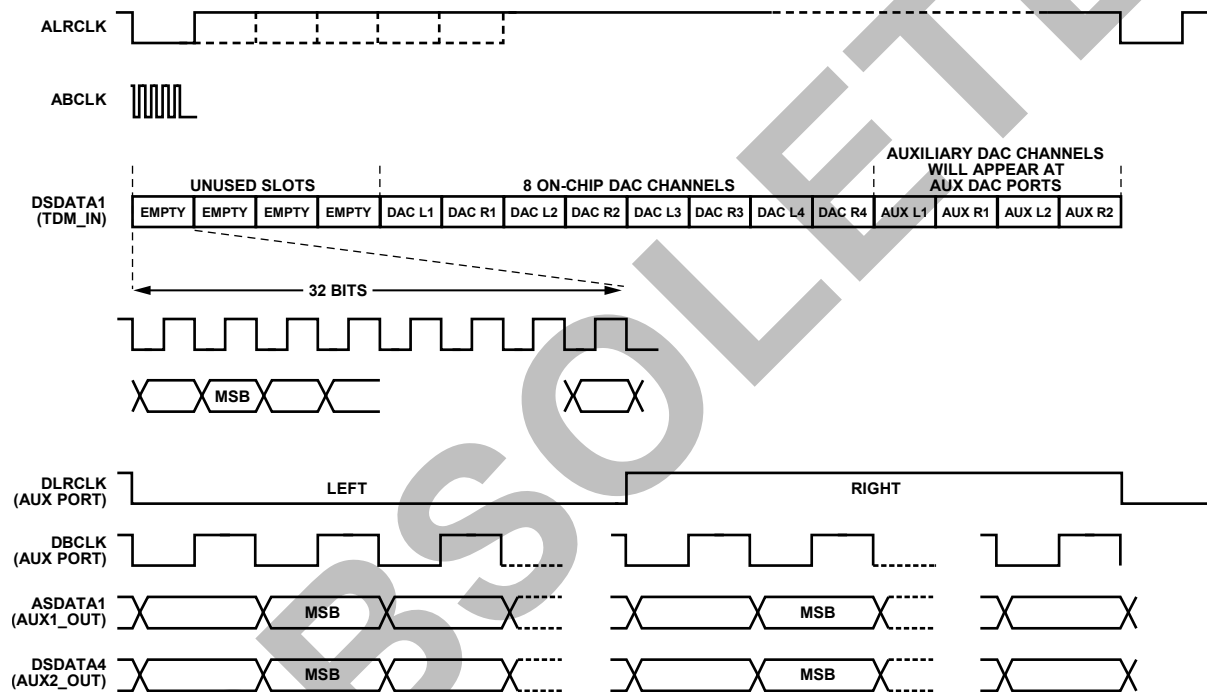

Figure 14. 16-Channel DAC TDM-AUX Mode

06623-014

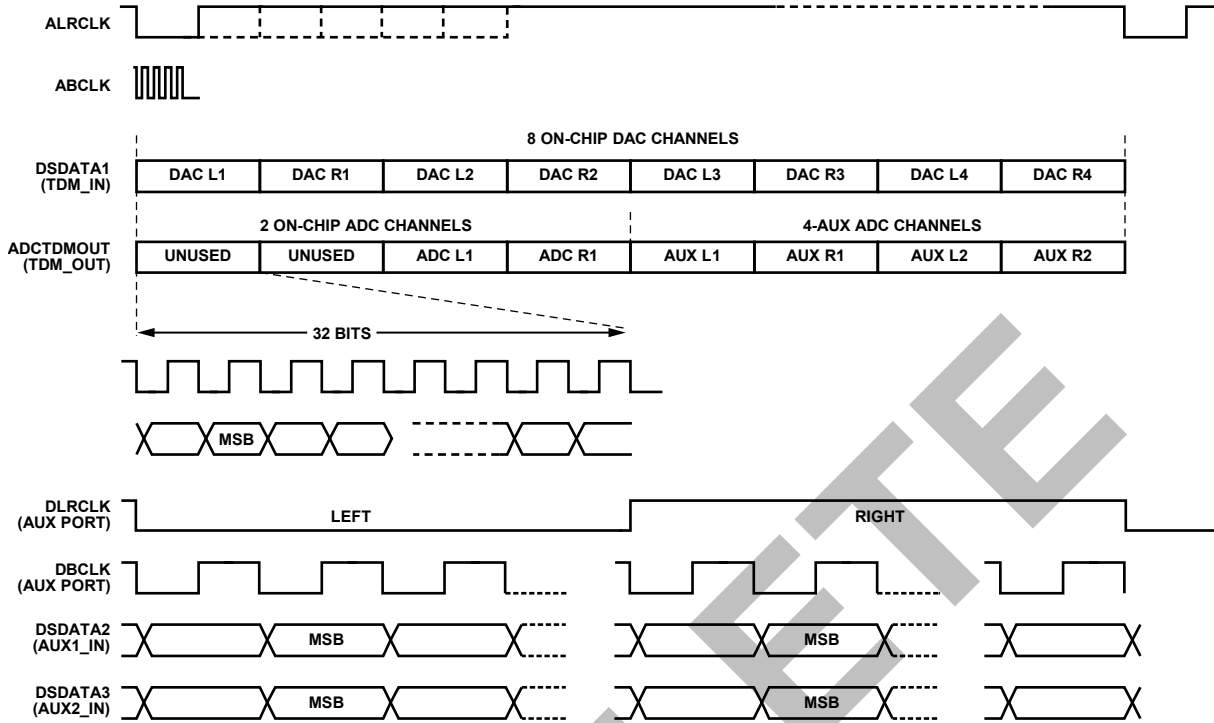

Figure 15. 6-Channel AUX ADC Mode

06623-015

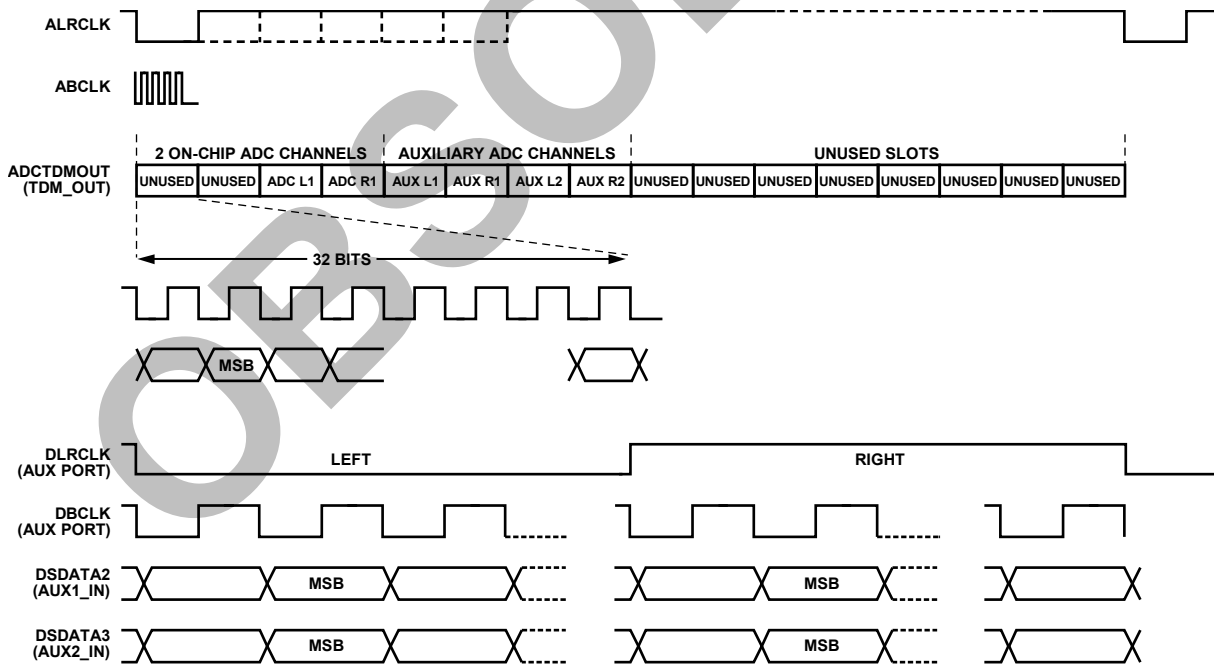

Figure 16. 14-Channel AUX ADC Mode

06623-016

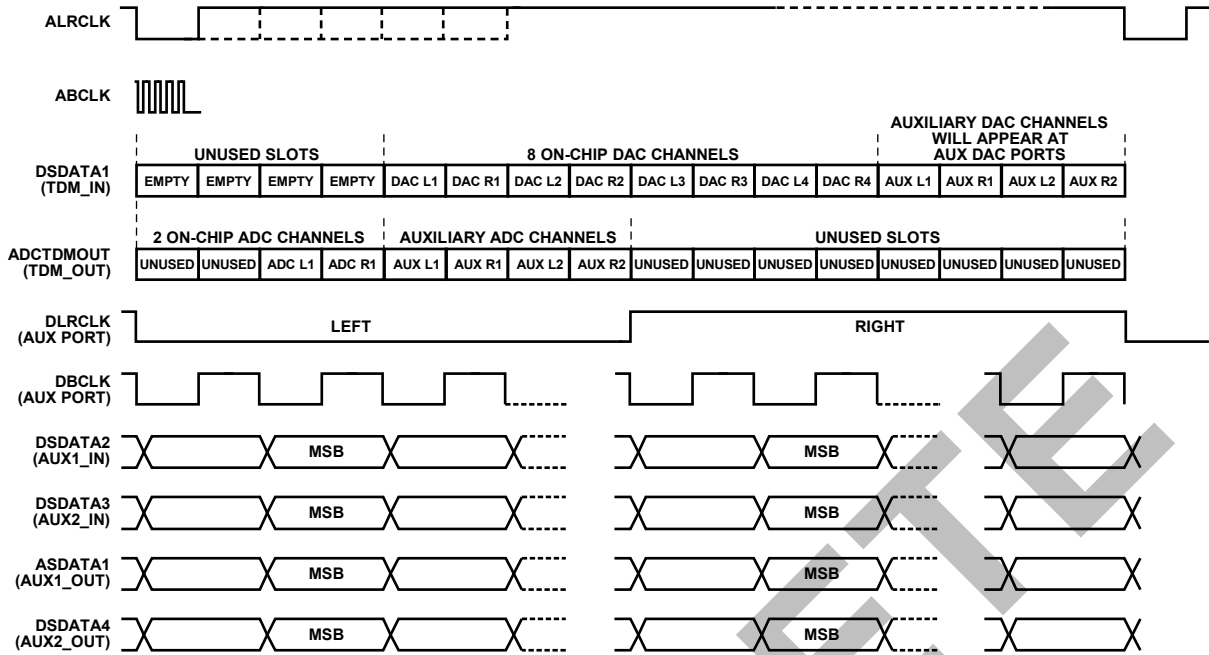

Figure 17. Combined AUX DAC and ADC Mode

06822-017

DAISY-CHAIN MODE

The AD1928 also allows a daisy-chain configuration to expand the system to 4 ADCs and 16 DACs (see Figure 18). In this mode, the DBCLK frequency is 512 fs. The first eight slots of the DAC TDM data stream belong to the first AD1928 in the chain and the last eight slots belong to the second AD1928. The second AD1928 is the device attached to the DSP TDM port.

To accommodate 16 channels at a 96 kHz sample rate, the AD1928 can be configured into a dual-line TDM mode, as shown in Figure 19. This mode allows a slower DBCLK than normally required by the one-line TDM mode.

Again, the first four channels of each TDM input belong to the first AD1928 in the chain and the last four channels belong to the second AD1928.

The dual-line TDM mode can also be used to send data at a 192 kHz sample rate into the AD1928, as shown in Figure 20.

There are two configurations for the ADC port to work in daisy-chain mode. The first one is with an ABCLK at 256 fs, shown in Figure 21. The second configuration is shown in Figure 22. Note that in the 512 fs ABCLK mode, the ADC channels occupy the first eight slots; the second eight slots are empty. The TDM_IN of the first AD1928 must be grounded in all modes of operation.

The input/output pins of the serial ports are defined according to the serial mode selected. See Table 13 for a detailed description of the function of each pin. See Figure 26 for a typical AD1928 configuration with two external stereo DACs and two external stereo ADCs.

Figure 23 through Figure 25 show the serial mode formats. For maximum flexibility, the polarity of LRCLK and BCLK are programmable. In these figures, all of the clocks are shown with their normal polarity. The default mode is I²S.

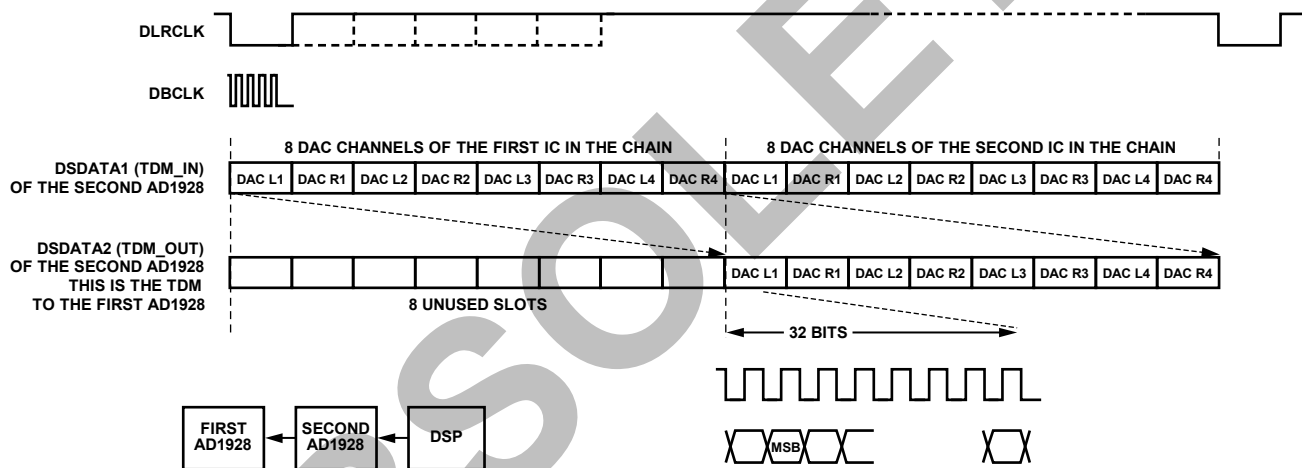

Figure 18. Single-Line DAC TDM Daisy-Chain Mode (Applicable to 48 kHz Sample Rate, 16-Channel, Two-AD1928 Daisy Chain)

06623-01B

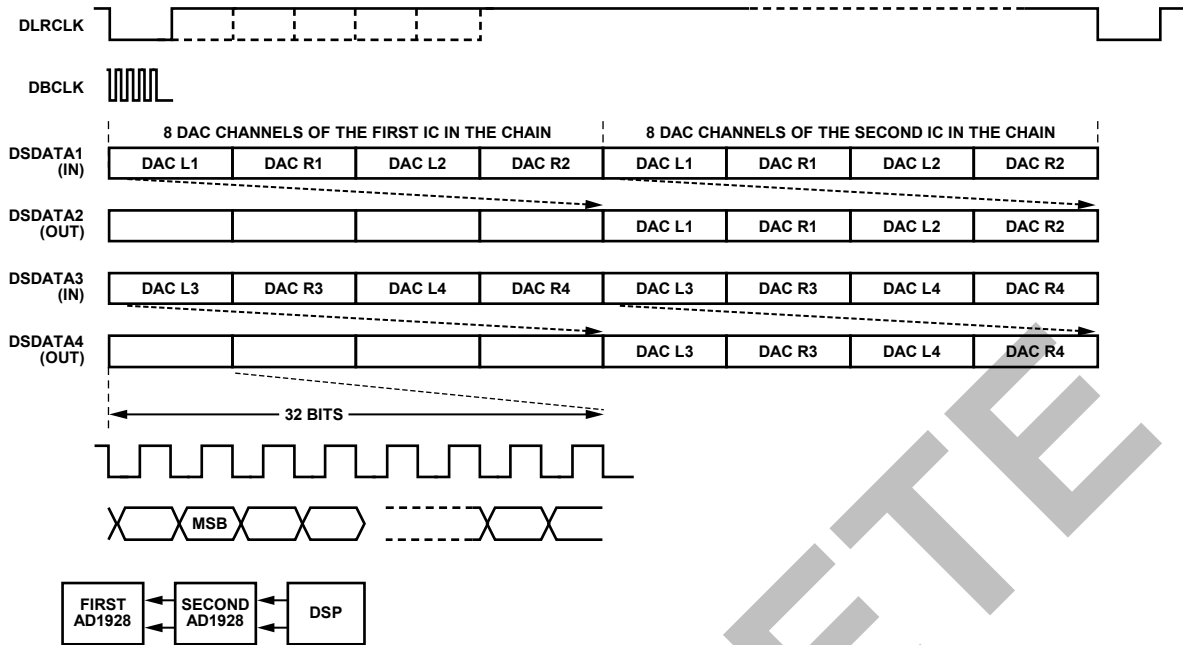

Figure 19. Dual-Line DAC TDM Mode (Applicable to 96 kHz Sample Rate, 16-Channel, Two-AD1928 Daisy Chain, DSDATA3 and DSDATA4 are the Daisy Chain)

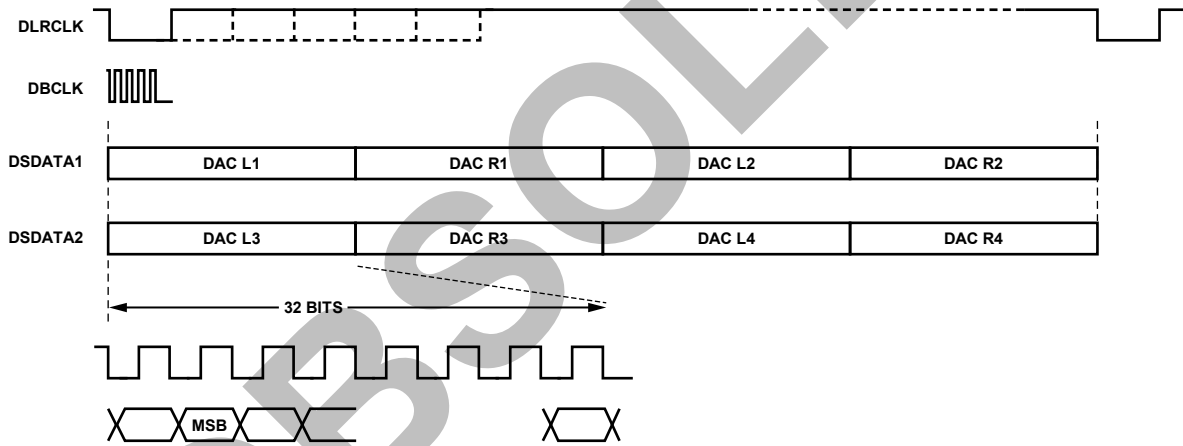

Figure 20. Dual-Line DAC TDM Mode (Applicable to 192 kHz Sample Rate, 8-Channel Mode)

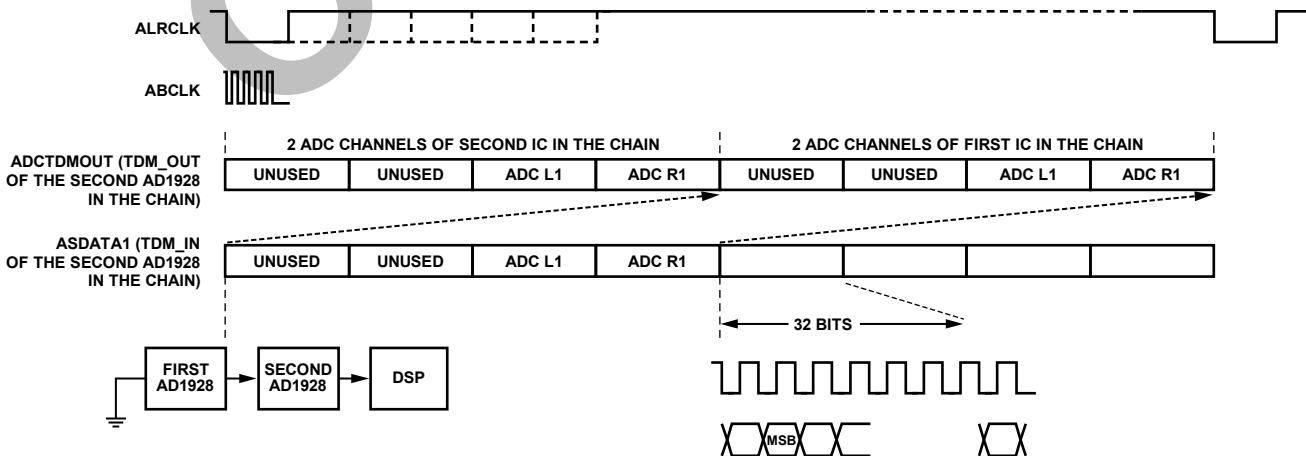

Figure 21. ADC TDM Daisy-Chain Mode (256 f_s BCLK, Two-AD1928 Daisy Chain)

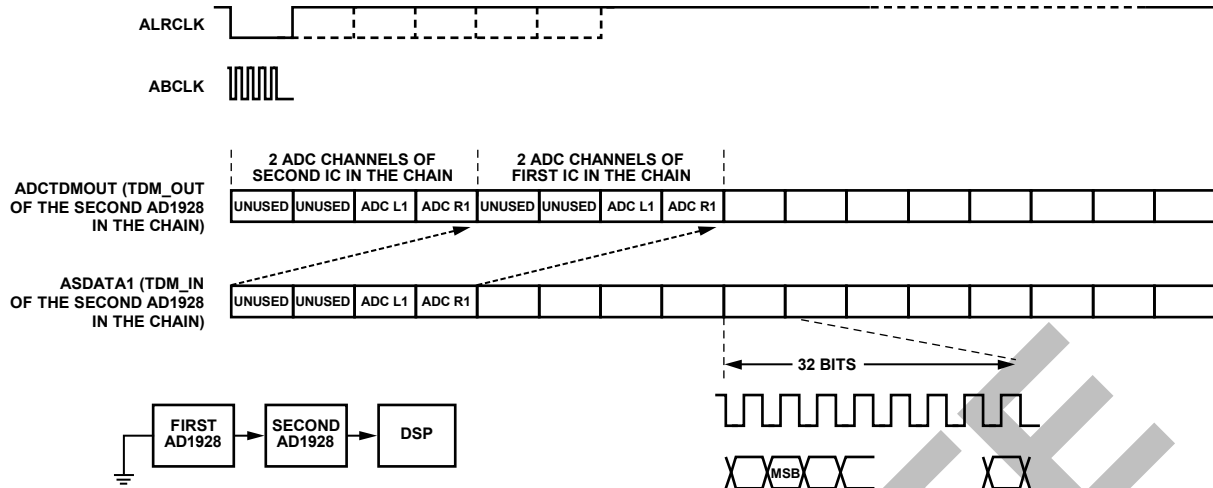
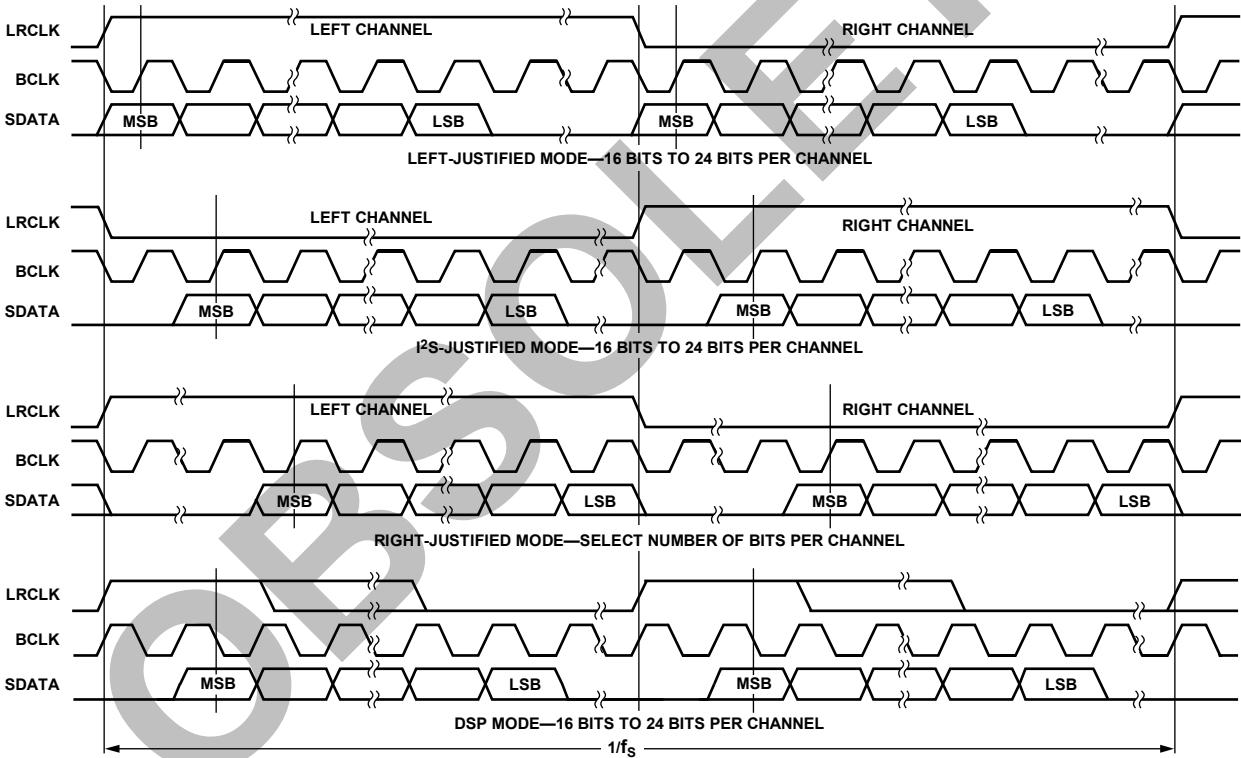

Figure 22. ADC TDM Daisy-Chain Mode (512 f_s BCLK, Two-AD1928 Daisy Chain)



NOTES

1. DSP MODE DOES NOT IDENTIFY CHANNEL.
2. LRCLK NORMALLY OPERATES AT f_s EXCEPT FOR DSP MODE WHICH, IS $2 \times f_s$.
3. BCLK FREQUENCY IS NORMALLY $64 \times$ LRCLK BUT MAY BE OPERATED IN BURST MODE.

Figure 23. Stereo Serial Modes

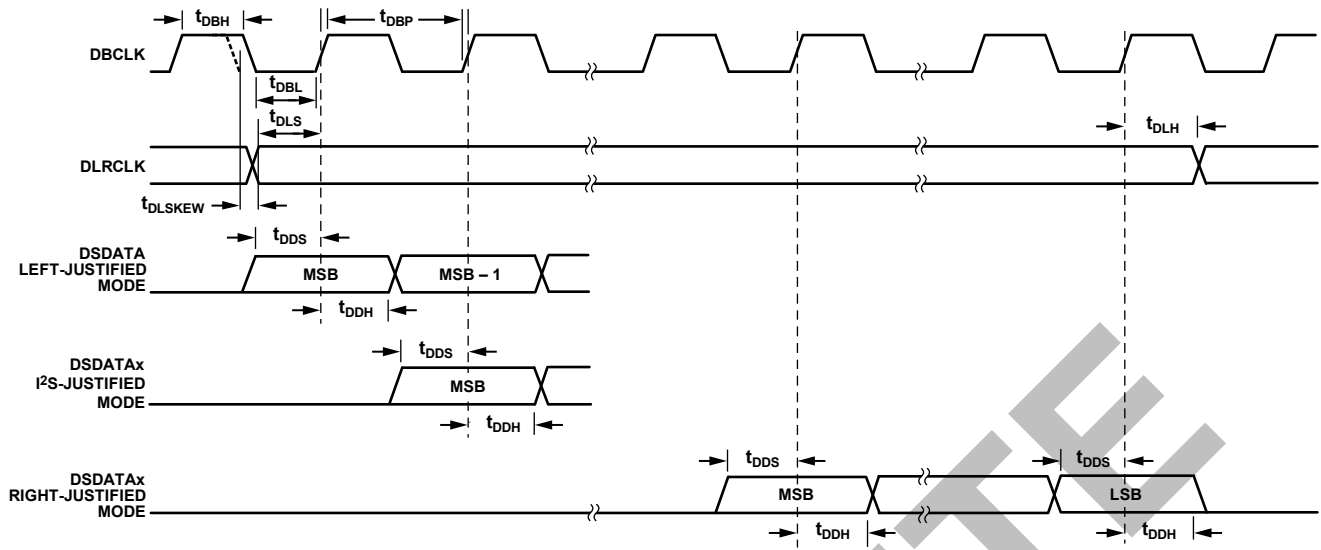

Figure 24. DAC Serial Timing

08623-024

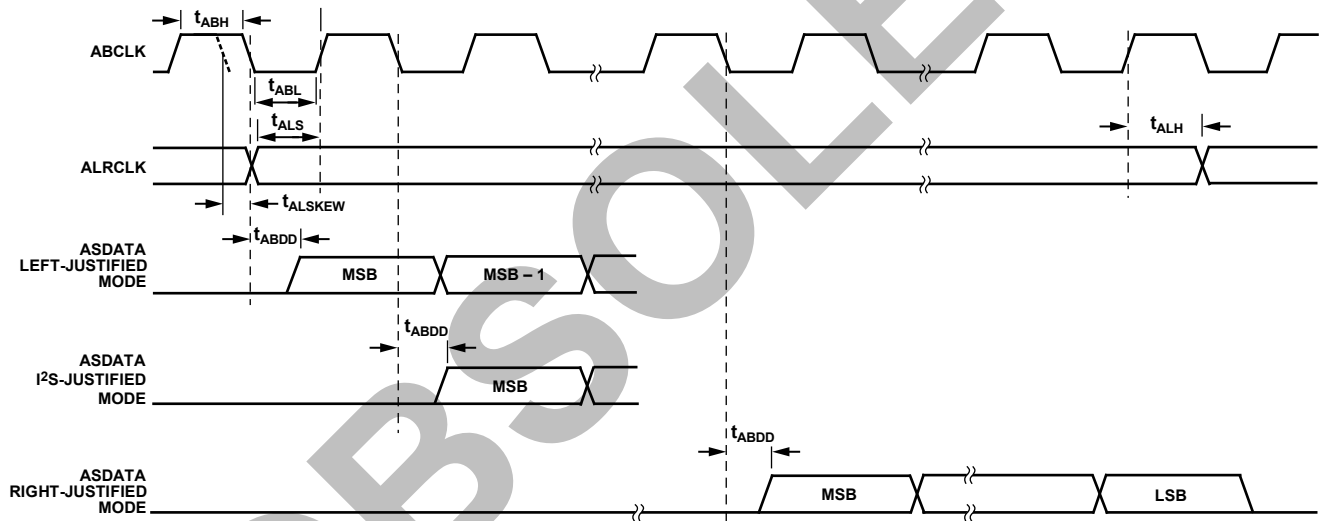

Figure 25. ADC Serial Timing

08623-025

Table 13. Pin Function Changes in TDM-AUX Mode (Replication of Table 12)

Mnemonic	Stereo Modes	TDM Modes	AUX Modes
ADCTDMOUT	NC	ADC TDM Data Output	TDM Data Output
ASDATA1	ADC1 Data Output	ADC TDM Data Input	AUX Data Output 1 (to External DAC 1)
DSDATA1	DAC1 Data Input	DAC TDM Data Input	TDM Data Input
DSDATA2	DAC2 Data Input	DAC TDM Data Output	AUX Data Input 1 (from External ADC 1)
DSDATA3	DAC3 Data Input	DAC TDM Data Input 2 (Dual-Line Mode)	AUX Data Input 2 (from External ADC 2)
DSDATA4	DAC4 Data Input	DAC TDM Data Output 2 (Dual-Line Mode)	AUX Data Output 2 (to External. DAC 2)
ALRCLK	ADC LRCLK Input/Output	ADC TDM Frame Sync Input/Output	TDM Frame Sync Input/Output
ABCLK	ADC BCLK Input/Output	ADC TDM BCLK Input/Output	TDM BCLK Input/Output
DLRCLK	DAC LRCLK Input/Output	DAC TDM Frame Sync Input/Output	AUX LRCLK Input/Output
DBCLK	DAC BCLK Input/Output	DAC TDM BCLK Input/Output	AUX BCLK Input/Output

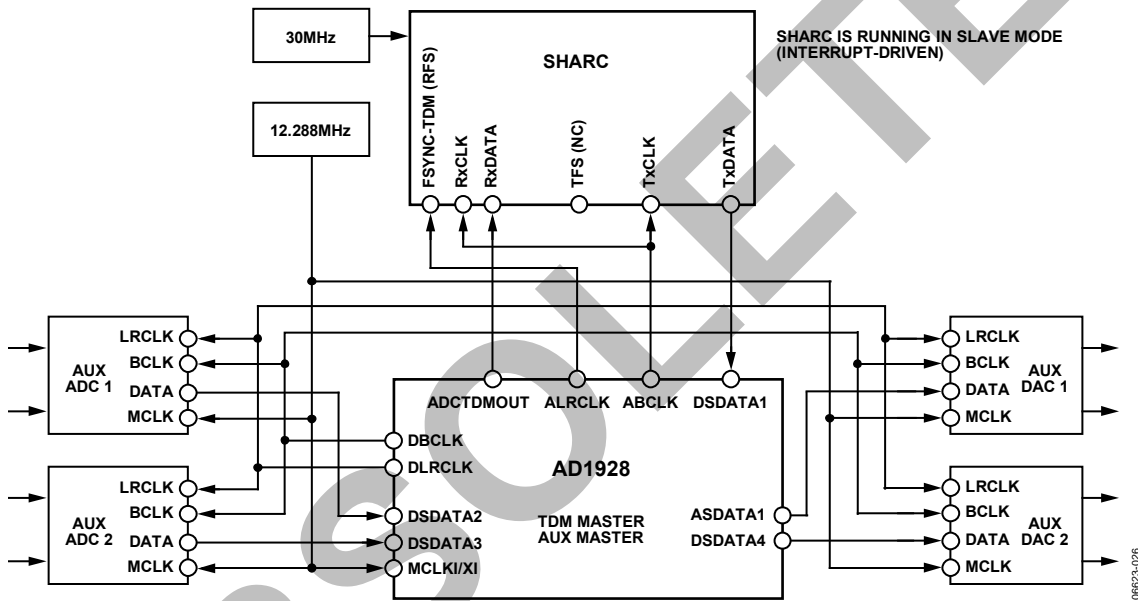

Figure 26. Example of AUX Mode Connection to SHARC® (AD1928 as TDM Master/AUX Master Shown)

CONTROL REGISTERS

DEFINITIONS

The global address for the AD1928 is 0x04, shifted left one bit due to the $\overline{R/W}$ bit. All registers are reset to 0, except for the DAC volume registers that are set to full volume. Note that the first setting in each control register parameter is the default setting.

Table 14. Register Format

	Global Address	R/W	Register Address	Data
Bit	23:17	16	15:8	7:0

Table 15. Register Addresses and Functions

Address	Function
0	PLL and Clock Control 0
1	PLL and Clock Control 1
2	DAC Control 0
3	DAC Control 1
4	DAC Control 2
5	DAC individual channel mutes
6	DAC 1L volume control
7	DAC 1R volume control
8	DAC 2L volume control
9	DAC 2R volume control
10	DAC 3L volume control
11	DAC 3R volume control
12	DAC 4L volume control
13	DAC 4R volume control
14	ADC Control 0
15	ADC Control 1
16	ADC Control 2

PLL AND CLOCK CONTROL REGISTERS

Table 16. PLL and Clock Control 0 Register

Bit	Value	Function	Description
0	0	Normal operation	PLL power-down
	1	Power-down	
2:1	00	Input 256 (×44.1 kHz or 48 kHz)	MCLKI/XI pin functionality (PLL active), master clock rate setting
	01	Input 384 (×44.1 kHz or 48 kHz)	
	10	Input 512 (×44.1 kHz or 48 kHz)	
	11	Input 768 (×44.1 kHz or 48 kHz)	
4:3	00	XTAL oscillator enabled	MCLKO/XO pin, master clock rate setting
	01	256 × f _s VCO output	
	10	512 × f _s VCO output	
	11	Off	
6:5	00	MCLKI/XI	PLL input
	01	DLRCLK	
	10	ALRCLK	
	11	Reserved	
7	0	Disable: ADC and DAC idle	Internal master clock enable
	1	Enable: ADC and DAC active	

Table 17. PLL and Clock Control 1 Register

Bit	Value	Function	Description
0	0	PLL clock	DAC clock source select
	1	MCLK	
1	0	PLL clock	ADC clock source select
	1	MCLK	
2	0	Enabled	On-chip voltage reference
	1	Disabled	
3	0	Not locked	PLL lock indicator (read only)
	1	Locked	
7:4	0000	Reserved	

DAC CONTROL REGISTERS

Table 18. DAC Control 0 Register

Bit	Value	Function	Description
0	0	Normal operation	Power-down
	1	Power-down	
2:1	00	32 kHz/44.1 kHz/48 kHz	Sample rates
	01	64 kHz/88.2 kHz/96 kHz	
	10	128 kHz/176.4 kHz/192 kHz	
	11	Reserved	
5:3	000	1	SDATA delay (BCLK periods)
	001	0	
	010	8	
	011	12	
	100	16	
	101	Reserved	
	110	Reserved	
	111	Reserved	
7:6	00	Stereo (normal)	Serial format
	01	TDM (daisy chain)	
	10	DAC AUX mode (ADC-, DAC-, TDM-coupled)	
	11	Dual-line TDM	

Table 19. DAC Control 1 Register

Bit	Value	Function	Description
0	0	Latch in midcycle (normal)	BCLK active edge (TDM in)
	1	Latch in at end of cycle (pipeline)	
2:1	00	64 (2 channels)	BCLKs per frame
	01	128 (4 channels)	
	10	256 (8 channels)	
	11	512 (16 channels)	
3	0	Left low	LRCLK polarity
	1	Left high	
4	0	Slave	LRCLK master/slave
	1	Master	
5	0	Slave	BCLK master/slave
	1	Master	
6	0	DBCLK pin	BCLK source
	1	Internally generated	
7	0	Normal	BCLK polarity
	1	Inverted	

AD1928

Table 20. DAC Control 2 Register

Bit	Value	Function	Description
0	0	Unmute	Master mute
	1	Mute	
2:1	00	Flat	De-emphasis (32 kHz/44.1 kHz/48 kHz mode only)
	01	48 kHz curve	
	10	44.1 kHz curve	
	11	32 kHz curve	
4:3	00	24	Word width
	01	20	
	10	Reserved	
	11	16	
5	0	Noninverted	DAC output polarity
	1	Inverted	
7:6	00	Reserved	

Table 21. DAC Individual Channel Mutes

Bit	Value	Function	Description
0	0	Unmute	DAC 1L mute
	1	Mute	
1	0	Unmute	DAC 1R mute
	1	Mute	
2	0	Unmute	DAC 2L mute
	1	Mute	
3	0	Unmute	DAC 2R mute
	1	Mute	
4	0	Unmute	DAC 3L mute
	1	Mute	
5	0	Unmute	DAC 3R mute
	1	Mute	
6	0	Unmute	DAC 4L mute
	1	Mute	
7	0	Unmute	DAC 4R mute
	1	Mute	

Table 22. DAC Volume Controls

Bit	Value	Function	Description
7:0	0	No attenuation	DAC volume control
	1 to 254	-3/8 dB per step	
	255	Full attenuation	

ADC CONTROL REGISTERS

Table 23. ADC Control 0 Register

Bit	Value	Function	Description
0	0	Normal operation	Power-down
	1	Power down	
1	0	Off	High-pass filter
	1	On	
2	0	Reserved	
3	0	Reserved	
4	0	Unmute	ADC 1L mute
	1	Mute	
5	0	Unmute	ADC 1R mute
	1	Mute	
7:6	00	32 kHz/44.1 kHz/48 kHz	Output sample rate
	01	64 kHz/88.2 kHz/96 kHz	
	10	128 kHz/176.4 kHz/192 kHz	
	11	Reserved	

Table 24. ADC Control 1 Register

Bit	Value	Function	Description
1:0	00	24	Word width
	01	20	
	10	Reserved	
	11	16	
4:2	000	1	SDATA delay (BCLK periods)
	001	0	
	010	8	
	011	12	
	100	16	
	101	Reserved	
	110	Reserved	
	111	Reserved	
6:5	00	Stereo	Serial format
	01	TDM (daisy chain)	
	10	ADC AUX mode (ADC-, DAC-, TDM-coupled)	
	11	Reserved	
7	0	Latch in midcycle (normal)	BCLK active edge (TDM in)
	1	Latch in at end of cycle (pipeline)	

AD1928

Table 25. ADC Control 2 Register

Bit	Value	Function	Description
0	0	50/50 (allows 32, 24, 20, 16 bit clocks (BCLKs) per channel)	LRCLK format
	1	Pulse (32 BCLKs per channel)	
1	0	Drive out on falling edge (DEF)	BCLK polarity
	1	Drive out on rising edge	
2	0	Left low	LRCLK polarity
	1	Left high	
3	0	Slave	LRCLK master/slave
	1	Master	
5:4	00	64	BCLKs per frame
	01	128	
	10	256	
	11	512	
6	0	Slave	BCLK master/slave
	1	Master	
7	0	ABCLK pin	BCLK source
	1	Internally generated	

ADDITIONAL MODES

The AD1928 offers several additional modes for board-level design enhancements. To reduce the EMI in board-level design, serial data can be transmitted without an explicit BCLK. See Figure 27 for an example of a DAC TDM data transmission mode that does not require high speed DBCLK. This configuration is applicable when the AD1928 master clock is generated by the PLL with the DLRCLK as the PLL reference frequency.

To relax the requirement for the setup time of the AD1928 in cases of high speed TDM data transmission, the AD1928 can latch in the data using the falling edge of DBCLK. This effectively dedicates the entire BCLK period to the setup time. This mode is useful in cases where the source has a large delay time in the serial data driver. Figure 28 shows this pipeline mode of data transmission.

Both the BCLK-less and pipeline modes are available on the ADC serial data port.

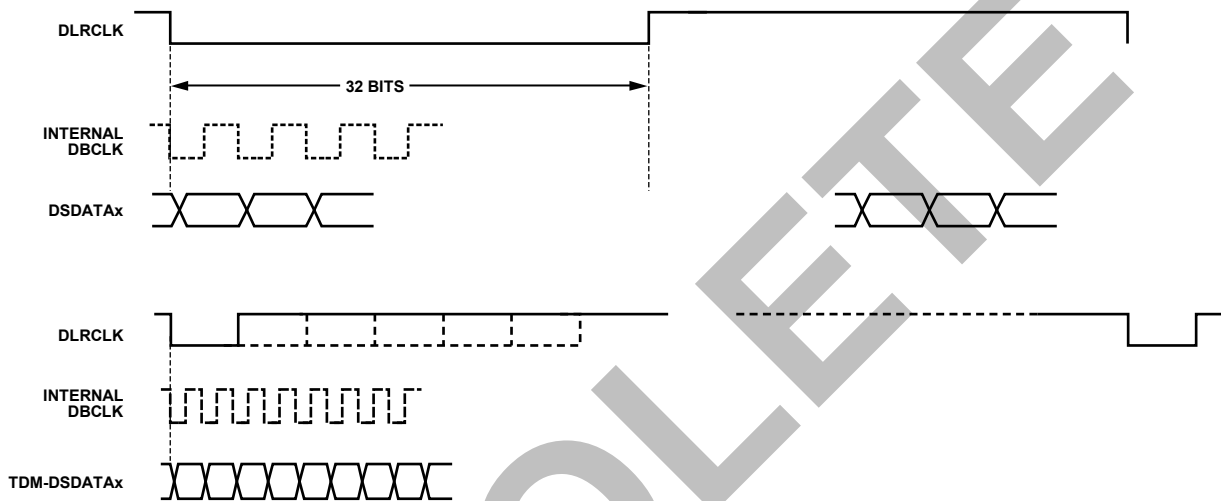

Figure 27. Serial DAC Data Transmission in TDM Format without DBCLK
(Applicable only if PLL locks to DLRCLK. This mode is also available in the ADC serial data port.)

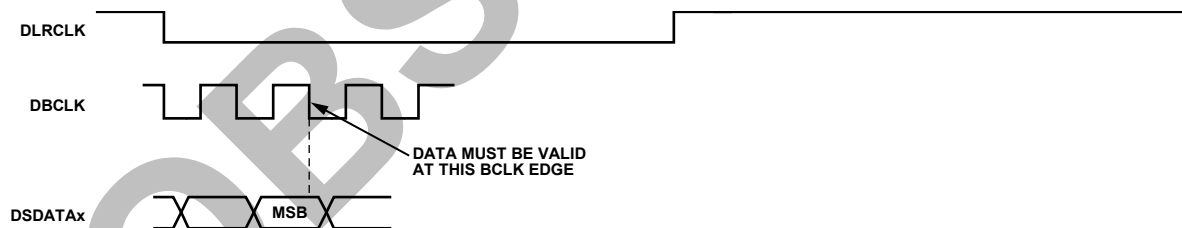

Figure 28. I²S Pipeline Mode in DAC Serial Data Transmission
(Applicable in stereo and TDM, useful for high frequency TDM transmission. This mode is also available in the ADC serial data port.)

APPLICATION CIRCUITS

Typical applications circuits are shown in Figure 29 through Figure 32. Figure 29 shows a typical ADC input filter circuit. Recommended loop filters for LR clock and master clock as the

PLL reference are shown in Figure 30. Output filters for the DAC outputs are shown in Figure 31 and Figure 32 for the noninverting and inverting cases.

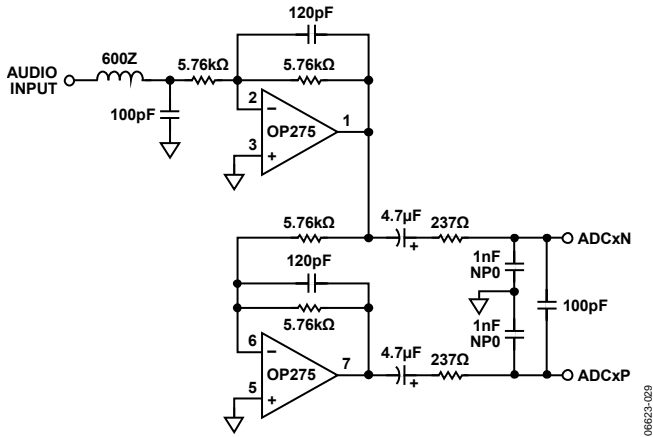

Figure 29. Typical ADC Input Filter Circuit

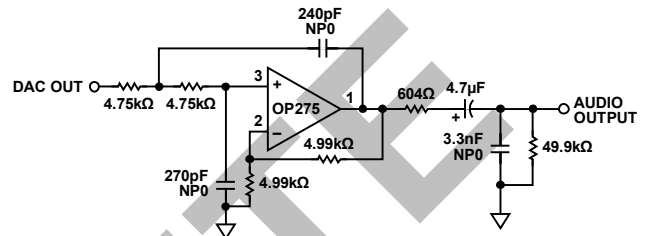

Figure 31. Typical DAC Output Filter Circuit (Single-Ended, Noninverting)

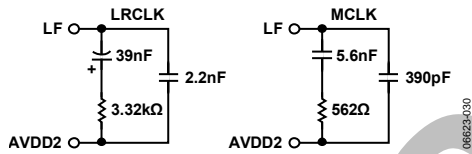

Figure 30. Recommended Loop Filters for LRCLK and MCLK PLL Reference

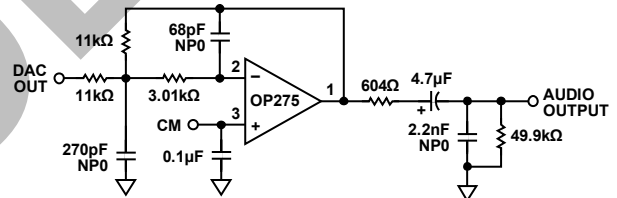
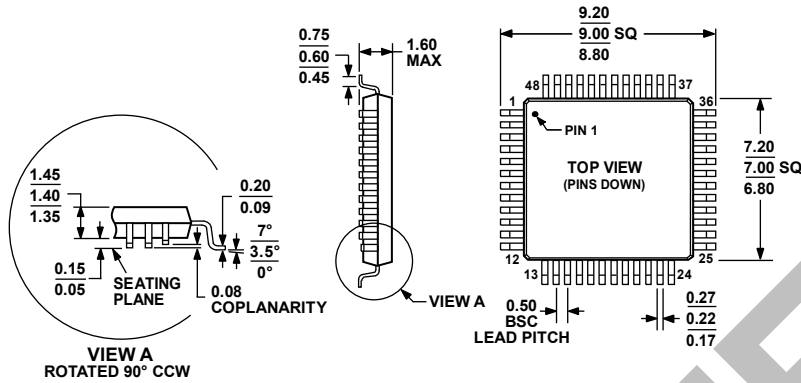

Figure 32. Typical DAC Output Filter Circuit (Single-Ended, Inverting)

OUTLINE DIMENSIONS



COMPLIANT TO JEDEC STANDARDS MS-026-BBC
 Figure 33. 48-Lead Low Profile Quad Flat Package [LQFP] (ST-48)
 Dimensions shown in millimeters

ORDERING GUIDE

Model ^{1, 2, 3}	Temperature Range	Package Description	Package Option
AD1928YSTZ	-40°C to +105°C	48-Lead LQFP	ST-48
AD1928YSTZ-RL	-40°C to +105°C	48-Lead LQFP, 13" Tape and Reel	ST-48
EVAL-AD1938AZ		Evaluation Board	

¹ Z = RoHS Compliant Part.

² For the AD1928YSTZ and AD1928YSTZ-RL: single-ended output; SPI control port.

³ The EVAL-AD1938AZ should be used as the evaluation board for the AD1928. The AD1938 is a functional equivalent to the AD1928, featuring two additional ADC channels.

NOTES

OBSOLETE

X-ON Electronics

Largest Supplier of Electrical and Electronic Components

Click to view similar products for [Interface - CODECs](#) category:

Click to view products by [Analog Devices](#) manufacturer:

Other Similar products are found below :

[CS4205-KQZ](#) [ADAU1777BCBZRL](#) [LE58QL021BVCT](#) [TSCS42A2X1NLGIZAX](#) [BU92001KN-E2](#) [TLC320AD52CPT](#) [TDA7293V-E](#)
[STA529Q](#) [SSM2603CPZ-REEL](#) [TLV320AIC14IDBT](#) [TLV320AIC23BIPWRQ1](#) [TLV320AIC23IPW](#) [TLV320AIC3262IYZFR](#)
[WM8904CGEFL/RV](#) [LE58QL063HVC](#) [SSM2167-1RMZ](#) [AD1836AASZ](#) [AD1836ACSZ](#) [ADAU1381BCPZ](#) [ADAU1761BCPZ](#)
[ADAU1761BCPZ-R7](#) [ADAU1787BCBZRL7](#) [ADAV801ASTZ](#) [SSM2603CPZ-REEL7](#) [AD74111YRUZ-REEL7](#) [AD74111YRUZ](#)
[AD1928YSTZ](#) [ADAU1328BSTZ](#) [ADV212BBCZ-150](#) [AD1938WBSTZ-RL](#) [SSM2604CPZ-REEL7](#) [CS4270-CZZ](#) [XD74LS42](#) [XD74LS48](#)
[XD74LS47](#) [XD74LS145](#) [XD74LS247](#) [XD74LS248](#) [PT2272-L4](#) [PT2262](#) [pt2272-m4](#) [AD2262](#) [EG201A](#) [HT12D](#) [CPC5750U](#) [GM7122](#)
[GM7121-D](#) [GM7123C](#) [CMX649E3](#) [MAX98050ENX+](#)