

**16-Bit, 2 MSPS/500 kSPS, Dual Channel SAR ADCs**
**FEATURES**

- ▶ High performance
  - ▶ Throughput: 2 MSPS (AD4630-16) or 500 kSPS (AD4632-16) per channel maximum
  - ▶ INL:  $\pm 3$  ppm maximum from  $-40^{\circ}\text{C}$  to  $+125^{\circ}\text{C}$
  - ▶ SNR: 97.4 dB typical
  - ▶ THD:  $-127$  dB typical
  - ▶ NSD:  $-157.4$  dBFS/Hz typical
- ▶ Low power
  - ▶ 15 mW per channel at 2 MSPS
  - ▶ 5 mW per channel at 500 kSPS
  - ▶ 1.5 mW per channel at 10 kSPS
- ▶ Easy Drive features reduce system complexity
  - ▶ Low  $0.6\ \mu\text{A}$  input current for DC inputs
  - ▶ Wide common-mode input range:  $-(1/128) \times V_{\text{REF}}$  to  $+(129/128) \times V_{\text{REF}}$
- ▶ Flexible external reference voltage range: 4.096 V to 5 V
  - ▶ Accurate integrated reference buffer with  $2\ \mu\text{F}$  bypass capacitor
- ▶ Programmable block averaging filter with up to  $2^{16}$  decimation
  - ▶ Extended sample resolution to 30 bits
  - ▶ Overrange and synchronization bits
- ▶ Flexi-SPI digital interface
  - ▶ 1, 2, or 4 SDO lanes per channel allows slower SCK
  - ▶ Echo clock mode simplifies use of digital isolator
  - ▶ Compatible with 1.2 V to 1.8 V logic
- ▶ **7 mm × 7 mm 64-Ball CSP\_BGA** package with internal supply and reference capacitors to help reduce system footprint

**APPLICATIONS**

- ▶ Automatic test equipment
- ▶ Digital control loops
- ▶ Medical instrumentation
- ▶ Seismology
- ▶ Semiconductor manufacturing
- ▶ Scientific instrumentation

**FUNCTIONAL BLOCK DIAGRAM**

Figure 1. Functional Block Diagram

**GENERAL DESCRIPTION**

The AD4630-16/AD4632-16 are 2-channel, simultaneous sampling, Easy Drive™, 2 MSPS or 500 kSPS successive approximation register (SAR), analog-to-digital converters (ADCs). With a guaranteed maximum  $\pm 3$  ppm integral nonlinearity (INL) and no missing codes at 16-bits, the AD4630-16/AD4632-16 achieve excellent precision from  $-40^{\circ}\text{C}$  to  $+125^{\circ}\text{C}$ . Figure 1 shows the functional architecture of the AD4630-16/AD4632-16.

A low-drift, internal precision-reference buffer eases voltage-reference sharing with other system circuitry. The AD4630-16/AD4632-16 offer a typical dynamic range of 97.4 dB when using a 5 V reference. The low noise floor enables signal chains utilizing less gain and lower power. A block averaging filter with programmable decimation ratio is available and can reduce noise for low-bandwidth signals, improving accuracy. The wide differential input and common-mode ranges allow inputs to use the full voltage reference ( $\pm V_{\text{REF}}$ ) range without saturating, simplifying signal-conditioning requirements and system calibration. The improved settling of the Easy Drive analog inputs broadens the selection of analog front end (AFE) components compatible with the AD4630-16/AD4632-16. Both single-ended and differential signals are supported.

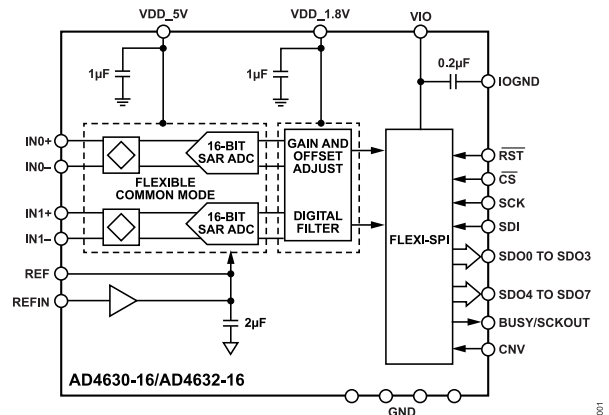
The versatile Flexi-SPI serial-peripheral interface (SPI) eases host processor and ADC integration. A wide data-clocking window, multiple serial-data output (SDO) lanes, and optional dual data rate (DDR) data clocking can reduce the serial clock to 10 MHz while operating at a sample rate of 2 MSPS. Echo clock mode can relax the timing requirements and simplify the use of digital isolators.

The ball grid array (BGA) package of the AD4630-16/AD4632-16 integrates all critical power supply and reference bypass capacitors, reducing the footprint and system-component count, and lessening sensitivity to board layout.

Rev. A

DOCUMENT FEEDBACK

TECHNICAL SUPPORT

Information furnished by Analog Devices is believed to be accurate and reliable "as is". However, no responsibility is assumed by Analog Devices for its use, nor for any infringements of patents or other rights of third parties that may result from its use. Specifications subject to change without notice. No license is granted by implication or otherwise under any patent or patent rights of Analog Devices. Trademarks and registered trademarks are the property of their respective owners.

## TABLE OF CONTENTS

Features.....	1	Power Supplies.....	25
Applications.....	1	Serial Interface.....	26
Functional Block Diagram.....	1	SPI Signals.....	26
General Description.....	1	Sample Conversion Timing and Data	
Specifications.....	4	Transfer.....	28
Timing Specifications.....	6	Clocking Modes .....	29
Absolute Maximum Ratings.....	11	Data Clocking Requirements and Timing.....	32
Thermal Resistance.....	11	Layout Guidelines.....	37
Electrostatic Discharge (ESD) Ratings.....	11	Registers.....	38
ESD Caution.....	11	Register Details.....	40
Pin Configuration and Function Descriptions.....	12	Interface Configuration A Register.....	40
Typical Performance Characteristics.....	14	Interface Configuration B Register.....	40
Terminology.....	19	Device Configuration Register.....	41
Integral Nonlinearity (INL) Error.....	19	Chip Type Register.....	41
Differential Nonlinearity (DNL) Error.....	19	Product ID Low Register.....	41
Zero Error.....	19	Product ID High Register.....	41
Gain Error.....	19	Chip Grade Register.....	42
Spurious-Free Dynamic Range (SFDR).....	19	Scratch Pad Register.....	42
Effective Number of Bits (ENOB).....	19	SPI Revision Register.....	42
Total Harmonic Distortion (THD).....	19	Vendor ID Low Register.....	43
Dynamic Range.....	19	Vendor ID High Register.....	43
Signal-to-Noise Ratio (SNR).....	19	Stream Mode Register.....	43
Signal-to-Noise-and-Distortion (SINAD)		Interface Status A Register.....	43
Ratio.....	19	Exit Configuration Mode Register.....	44
Aperture Delay.....	19	Averaging Mode Register.....	44
Transient Response.....	19	Channel 0 Offset Registers.....	45
Common-Mode Rejection Ratio (CMRR).....	19	Channel 1 Offset Registers.....	45
Power Supply Rejection Ratio (PSRR).....	19	Channel 0 Gain Registers.....	45
Theory of Operation.....	20	Channel 1 Gain Registers.....	46
Overview.....	20	Modes Register.....	46
Converter Operation.....	20	Internal Oscillator Register.....	47
Transfer Function.....	20	Output Driver Register.....	47
Analog Features.....	21	Test Pattern Registers.....	48
Digital Sample Processing Features.....	21	Digital Diagnostics Register.....	49
Applications Information.....	23	Digital Errors Register.....	49
Typical Application Diagram.....	23	Outline Dimensions.....	50
Analog Front-End Design.....	23	Ordering Guide.....	50
Reference Circuitry Design .....	23	Evaluation Boards.....	51
Device Reset.....	25		

## REVISION HISTORY

### 10/2022—Rev. 0 to Rev. A

Added AD4632-16.....	1
Changes to Features Section and General Description Section.....	1
Changes to Specifications Section and Table 1.....	4
Changes to Timing Specifications Section and Table 2 .....	6
Changes to Figure 23 Caption .....	15
Add Figure 24 and Figure 29; Renumbered Sequentially.....	16

**TABLE OF CONTENTS**

Changes to Figure 28 Caption.....	16
Changes to Figure 33 Caption .....	17
Add Figure 34.....	17
Changes to Overview Section.....	20
Changes to Figure 52 Section.....	30
Changes to 1-Lane, SDR Mode, Echo Clock Mode Section.....	36
Changes to Register 0x06, CHIP_GRADE, Reset Column, Table 16 .....	38
Changes to Chip Grade Register Section.....	42
Changes to Ordering Guide.....	50
Changes to Evaluation Boards Section.....	51

**7/2022—Revision 0: Initial Version**

## SPECIFICATIONS

VDD\_5V = 5.4 V, VDD\_1.8V = 1.8 V, VIO = 1.8 V, REFIN = 5 V, input common mode = 2.5 V, sampling frequency ( $f_S$ ) = 2 MSPS or 500 KSPS for the AD4630-16/AD4632-16, respectively, and all specifications T<sub>MIN</sub> to T<sub>MAX</sub>, unless otherwise noted. Typical values are at T<sub>A</sub> = 25°C.

Table 1. Specifications

Parameter	Test Conditions/Comments	Min	Typ	Max	Unit
RESOLUTION		16			Bits
ANALOG INPUT					
Voltage Range	INx+ voltage (V <sub>INx+</sub> ) - INx- voltage (V <sub>INx-</sub> )	$-(65/64) \times V_{REF}$		$+(65/64) \times V_{REF}$	V
Absolute Input Voltage	V <sub>INx+</sub> , V <sub>INx-</sub> to GND	$-(1/128) \times V_{REF}$		$+(129/128) \times V_{REF}$	V
Common-Mode Input Range	(V <sub>INx+</sub> + V <sub>INx-</sub> )/2	$-(1/128) \times V_{REF}$		$+(129/128) \times V_{REF}$	V
Common-Mode Rejection Ratio (CMRR)	Input frequency (f <sub>IN</sub> ) = 10 kHz		132		dB
Analog Input Current	Acquisition phase, T <sub>A</sub> = 25°C		0.4		nA
	Converting any DC input at 2 MSPS		0.6		μA
Analog Input Capacitance	Acquisition phase		60		pF
	Outside acquisition phase (pin capacitance (C <sub>PIN</sub> ))		2		pF
THROUGHPUT					
Complete Cycle					
AD4630-16		500			ns
AD4632-16		2000			ns
Conversion Time		264	282	300	ns
Acquisition Phase <sup>1</sup>					
AD4630-16		244	260	275	ns
AD4632-16		1744	1760	1775	ns
Throughput Rate					
AD4630-16		0		2	MSPS
AD4632-16		0		500	kSPS
DC ACCURACY					
No Missing Codes		16			Bits
Integral Nonlinearity (INL) Error		-3	±1	+3	ppm
Differential Nonlinearity (DNL) Error			±0.05		LSB
Transition Noise			0.12		LSB rms
Zero Error		-150	0	+150	μV
Zero-Error Drift			±0.05		ppm/°C
Gain Error	Buffer disabled, REF = 5 V	-0.005	±0.0005	+0.005	%FS
	Buffer enabled, REFIN = 5 V	-0.01	±0.001	+0.01	%FS
Gain-Error Temperature Drift	Buffer disabled, REF = 5 V		±0.05		ppm/°C
	Buffer enabled, REFIN = 5 V		±0.1		ppm/°C
Power-Supply Sensitivity	VDD_5V = 5.4 V ± 0.1 V		±0.1		ppm
	VDD_1.8V = 1.8 V ± 5%		±0.2		ppm
AC ACCURACY					
Dynamic Range			97.4		dB
Noise Spectral Density (NSD) <sup>2</sup>			-157.4		dBFS/Hz
Total RMS Noise			47.7		μV rms
Signal to Noise Ratio (SNR)	f <sub>IN</sub> = 1 kHz, -0.5 dBFS	96	97.4		dB
Spurious-Free Dynamic Range (SFDR)	f <sub>IN</sub> = 1 kHz, -0.5 dBFS		127		dB
Total Harmonic Distortion (THD)	f <sub>IN</sub> = 1 kHz, -0.5 dBFS		-127	-112	dB
Signal-to-Noise-and-Distortion (SINAD) Ratio	f <sub>IN</sub> = 1 kHz, -0.5 dBFS	96	97.4		dB
SNR	VDD_5V = 5.0 V, f <sub>IN</sub> = 1 kHz, -0.5 dBFS, REFIN = 4.096 V		97.1		dB

## SPECIFICATIONS

Table 1. Specifications

Parameter	Test Conditions/Comments	Min	Typ	Max	Unit
SFDR	VDD_5V = 5.0 V, f <sub>IN</sub> = 1 kHz, -0.5 dBFS, REFIN = 4.096 V		130		dB
THD	VDD_5V = 5.0 V, f <sub>IN</sub> = 1 kHz, -0.5 dBFS, REFIN = 4.096 V		-130		dB
SINAD	VDD_5V = 5.0 V, f <sub>IN</sub> = 1 kHz, -0.5 dBFS, REFIN = 4.096 V		97.1		dB
SNR	f <sub>IN</sub> = 100 kHz, -0.5 dBFS		97.3		dB
THD	f <sub>IN</sub> = 100 kHz, -0.5 dBFS		-113		dB
SINAD	f <sub>IN</sub> = 100 kHz, -0.5 dBFS		97.2		dB
-3 dB Input Bandwidth			74		MHz
Aperture Delay			0.7		ns
Aperture Jitter			1.4		ps rms
CHANNEL-TO-CHANNEL CROSSTALK	f <sub>IN</sub> = 1 kHz, 1.3 kHz		-135		dB
INTERNAL REFERENCE BUFFER	External reference drives REFIN				
REFIN Voltage Range	5.3 V ≤ VDD_5V ≤ 5.5 V	4.95	5	5.05	V
	4.8 V ≤ VDD_5V ≤ 5.25 V		4.5		V
	4.75 V ≤ VDD_5V ≤ 5.25 V	4.046	4.096	4.146	V
REFIN Bias Current		-50	5	+50	nA
REFIN Input Capacitance			40		pF
Reference Buffer Offset Error	REFIN = 5 V, T <sub>A</sub> = 25°C	-100	±25	+100	μV
	REFIN = 4.5 V, T <sub>A</sub> = 25°C		±25		μV
	REFIN = 4.096 V, T <sub>A</sub> = 25°C	-100	±25	+100	μV
Reference Buffer Offset Drift			±0.3		μV/°C
Power-On Settling Time			3		ms
EXTERNALLY OVERDRIVEN REFERENCE	External reference drives REF (REFIN = 0 V)				
REF Voltage Range	5.3 V ≤ VDD_5V ≤ 5.5 V	4.95	5	5.05	V
	4.8 V ≤ VDD_5V ≤ 5.25 V		4.5		V
	4.75 V ≤ VDD_5V ≤ 5.25 V	4.046	4.096	4.146	V
REF Current					
AD4630-16	f <sub>S</sub> = 2 MSPS		1.8		μA
AD4632-16	f <sub>S</sub> = 500 kSPS		0.5		μA
REF Input Capacitance			2		μF
DIGITAL INPUTS	1.14 V ≤ VIO ≤ 1.89 V				
Logic Levels					
Input-Voltage Low (V <sub>IL</sub> )		-0.3		+0.35 × VIO	V
Input-Voltage High (V <sub>IH</sub> )		0.65 × VIO		VIO + 0.3	V
Input-Current Low (I <sub>IL</sub> )		-10		+10	μA
Input-Current High (I <sub>IH</sub> )		-10		+10	μA
Input Pin Capacitance			2		pF
DIGITAL OUTPUTS	1.14 V ≤ VIO ≤ 1.89 V				
Pipeline Delay					Conversion results available immediately after completed conversion
Output-Voltage Low (V <sub>OL</sub> )	Sink current (I <sub>SINK</sub> ) = 2 mA			0.25 × VIO	V
Output-Voltage High (V <sub>OH</sub> )	Source current (I <sub>SOURCE</sub> ) = 2 mA	0.75 × VIO			V
POWER SUPPLIES					
VDD_5V	REF = 5 V	5.3	5.4	5.5	V
	REF = 4.5 V	4.8	5	5.25	V

## SPECIFICATIONS

Table 1. Specifications

Parameter	Test Conditions/Comments	Min	Typ	Max	Unit
	REF = 4.096 V	4.75	5	5.25	V
VDD_1.8V		1.71	1.8	1.89	V
VIO <sup>3</sup>		1.14		1.89	V
Standby Current					
VDD_5V			500		μA
VDD_1.8V			90		μA
VIO			<1		μA
Shutdown Current					
VDD_5V			5		μA
VDD_1.8V			5		μA
VIO			<1		μA
Operating Current, AD4630-16	Both channels active, 2 MSPS				
VDD_5V	VDD_5V = 5.4 V		2.7	3.2	mA
VDD_1.8V	VDD_1.8V = 1.8 V		8.2	11.2	mA
VIO	VIO = 1.8 V, 1-lane SDO		0.6		mA
Operating Current, AD4632-16	Both channels active, 500 kSPS				
VDD_5V	VDD_5V = 5.4 V		1.1	1.5	mA
VDD_1.8V	VDD_1.8V = 1.8 V		2.1	3.1	mA
VIO	VIO = 1.8 V, 1-lane SDO		0.15		mA
Power Dissipation	Both channels active, 2 MSPS		30	39	mW
	Both channels active, 500 kSPS		10	14.2	mW
t <sub>RESET_DELAY</sub>	After power on, delay from VDD_5V and VDD_1.8V valid to $\overline{RST}$ assertion	3			ms
t <sub>RESET_PW</sub>	$\overline{RST}$ pulse width	50			ns
TEMPERATURE RANGE					
Specified Performance	T <sub>MIN</sub> to T <sub>MAX</sub>	-40		+125	°C

<sup>1</sup> The acquisition phase is the time available for the input sampling capacitors to acquire a new input with the ADC running at a throughput rate of 2 MSPS for the AD4630-16 and a throughput rate of 500 kSPS for the AD4632-16.

<sup>2</sup> 1/f noise is canceled internally by auto-zeroing. Noise spectral density is substantially uniform from DC to  $f_S/2$ .

<sup>3</sup> When VIO < 1.4V, Bit IO2X must be set to 1. See the [Output Driver Register](#) section.

## TIMING SPECIFICATIONS

VDD\_5V = 5.4 V, VDD\_1.8V = 1.8 V, VIO = 1.8 V, REFIN = 5 V, input common mode = 2.5 V,  $f_S$  = 2 MSPS and 500 kSPS for the AD4630-16/AD4632-16, respectively, and all specifications T<sub>MIN</sub> to T<sub>MAX</sub>, unless otherwise noted. Typical values are at T<sub>A</sub> = 25°C. See [Figure 2](#) for the timing voltage levels. For VIO < 1.4 V, Bit IO2X must be set to 1.

Table 2. Digital Timing Interface

Parameter <sup>1</sup>	Symbol	Min	Typ	Max	Unit
Conversion Time—CNV Rising Edge to Data Available	t <sub>CONV</sub>	264	282	300	ns
Acquisition Phase <sup>2</sup>	t <sub>ACQ</sub>				
AD4630-16		244	260	275	ns
AD4632-16		1744	1760	1755	ns
Time Between Conversions	t <sub>CYC</sub>				
AD4630-16		500			ns
AD4632-16		2000			ns
CNV High Time	t <sub>CNVH</sub>	10			ns

**SPECIFICATIONS**

**Table 2. Digital Timing Interface**

Parameter <sup>1</sup>	Symbol	Min	Typ	Max	Unit
CNV Low Time	$t_{CNVL}$	20			ns
Internal Oscillator Frequency	$f_{OSC}$	75.1	80	84.7	MHz

- <sup>1</sup> Timing specifications assume a 5 pF load capacitance on the digital output pins.  $t_{CONV}$ ,  $t_{CYC}$ ,  $t_{SCK}$ , and  $t_{SCKOUT}$  are production tested. All other timing specifications are guaranteed by characterization and design.
- <sup>2</sup> The acquisition phase is the time available for the input sampling capacitors to acquire a new input with the ADC running at a throughput rate of 2 MSPS and 500 kSPS for the AD4630-16/AD4632-16, respectively.

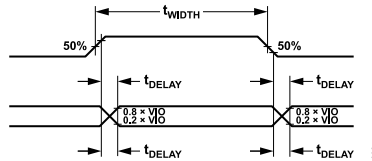

**Figure 2. Voltage Levels for Timing**

**Table 3. Register Read/Write Timing**

Parameter	Symbol	Min	Typ	Max	Unit
$\overline{CS}$ Pulse Width	$t_{CSPW}$	10			ns
SCK Period	$t_{SCK}$				
$V_{IO} > 1.71$ V		11.6			ns
$V_{IO} > 1.14$ V		12.3			ns
SCK Low Time	$t_{SCKL}$	5.2			ns
SCK High Time	$t_{SCKH}$	5.2			ns
SCK Falling Edge to Data Remains Valid	$t_{HSDO}$	2.1			ns
SCK Falling Edge to Data Valid Delay	$t_{DSDO}$				
$V_{IO} > 1.71$ V				9.4	ns
$V_{IO} > 1.14$ V				11.8	ns
$\overline{CS}$ Rising Edge to SDO High Impedance	$t_{CSDIS}$			9	ns
SDI Valid Setup Time to SCK Rising Edge	$t_{SSDI}$	1.5			ns
SDI Valid Hold Time from SCK Rising Edge	$t_{HSDI}$	1.5			ns
$\overline{CS}$ Falling Edge to First SCK Rising Edge	$t_{CSSCK}$				
$V_{IO} > 1.71$ V		11.6			ns
$V_{IO} > 1.14$ V		12.3			ns
Last SCK Edge to $\overline{CS}$ Rising Edge	$t_{SCKCS}$	5.2			ns

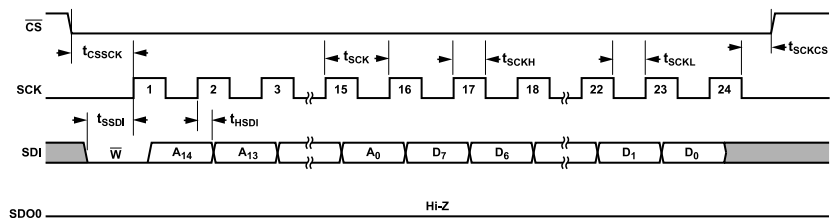

**Figure 3. Register Configuration Mode Write Timing**

SPECIFICATIONS

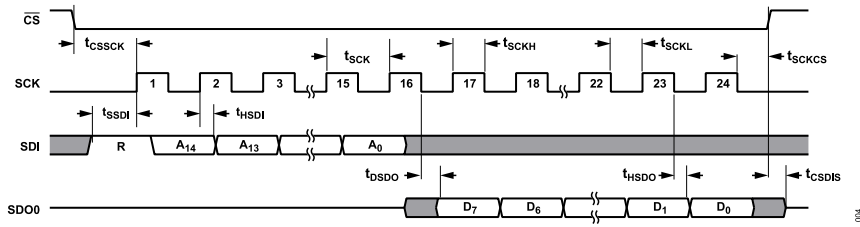

Figure 4. Register Configuration Mode Read Timing

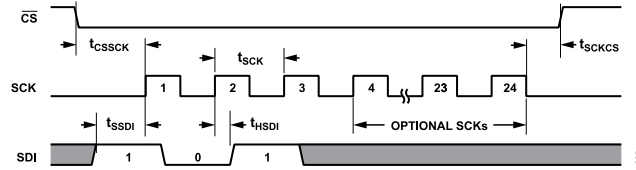

Figure 5. Register Configuration Mode Command Timing

Table 4. SPI-Compatible Mode Timing

Parameter	Symbol	Min	Typ	Max	Unit
SCK Period	$t_{SCK}$	9.8			ns
VIO > 1.71 V		12.3			ns
VIO > 1.14 V					
SCK Low Time	$t_{SCKL}$	4.2			ns
VIO > 1.71 V		5.2			ns
VIO > 1.14 V					
SCK High Time	$t_{SCKH}$	4.2			ns
VIO > 1.71 V		5.2			ns
VIO > 1.14 V					
SCK Falling Edge to Data Remains Valid	$t_{HSDO}$	1.4			ns
SCK Falling Edge to Data Valid Delay	$t_{DSDO}$			5.6	ns
VIO > 1.71 V				8.1	ns
VIO > 1.14 V					
$\overline{CS}$ Falling Edge to SDO Valid	$t_{CSEN}$			6.8	ns
VIO > 1.71 V				9.3	ns
VIO > 1.14 V					
$\overline{CS}$ Falling Edge to First SCK Rising Edge	$t_{CSSCK}$	9.8			ns
VIO > 1.71 V		12.3			ns
VIO > 1.14 V					
Last SCK Edge to $\overline{CS}$ Rising Edge	$t_{SCKCS}$	4.2			ns
$\overline{CS}$ Rising Edge to SDO High Impedance	$t_{CSDIS}$			9	ns
$\overline{CS}$ Falling Edge to BUSY Rising Edge	$t_{CSBUSY}$		6		ns

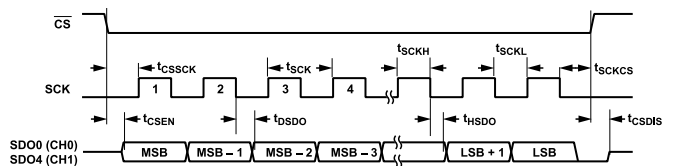

Figure 6. SPI Clcking Mode 1-Lane Single Data-Rate (SDR) Timing



SPECIFICATIONS

Table 5. Echo Clock Mode Timing, SDR, 1-Lane

Parameter	Symbol	Min	Typ	Max	Unit
SCK Period	$t_{SCK}$	9.8			ns
VIO > 1.71 V		12.3			ns
VIO > 1.14 V					
SCK Low Time, SCK High Time	$t_{SCKL}, t_{SCKH}$	4.2			ns
VIO > 1.71 V		5.2			ns
VIO > 1.14 V					
SCK Rising Edge to Data/SCKOUT Remains Valid	$t_{HSDO}$	1.1			ns
SCK Rising Edge to Data/SCKOUT Valid Delay	$t_{DSDO}$			5.6	ns
VIO > 1.71 V				8.1	ns
VIO > 1.14 V					
$\overline{CS}$ Falling Edge to First SCK Rising Edge	$t_{CSSCK}$	9.8			ns
VIO > 1.71 V		12.3			ns
VIO > 1.14 V					
Skew Between Data and SCKOUT	$t_{SKEW}$	-0.4	0	+0.4	ns
Last SCK Edge to $\overline{CS}$ Rising Edge	$t_{SCKCS}$	4.2			ns
$\overline{CS}$ Rising Edge to SDO High Impedance	$t_{CSDIS}$			9	ns

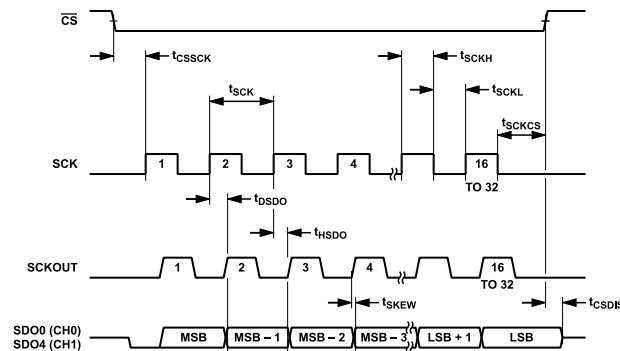

Figure 7. Echo Clock Mode Timing, SDR, 1-Lane

Table 6. Echo Clock Mode Timing, DDR, 1-Lane

Parameter	Symbol	Min	Typ	Max	Unit
SCK Period	$t_{SCK}$	12.3			ns
SCK Low Time, SCK High Time	$t_{SCKL}, t_{SCKH}$	5.2			ns
SCK Edge to Data/SCKOUT Remains Valid	$t_{HSDO}$	1.1			ns
SCK Edge to Data/SCKOUT Valid Delay	$t_{DSDO}$			6.2	ns
VIO > 1.71 V				8.7	ns
VIO > 1.14 V					
$\overline{CS}$ Falling Edge to First SCK Rising Edge	$t_{CSSCK}$	12.3			ns
Skew Between Data and SCKOUT	$t_{SKEW}$	-0.4	0	+0.4	ns
Last SCK Edge to $\overline{CS}$ Rising Edge	$t_{SCKCS}$	9			ns
$\overline{CS}$ Rising Edge to SDO High Impedance	$t_{CSDIS}$			9	ns

SPECIFICATIONS

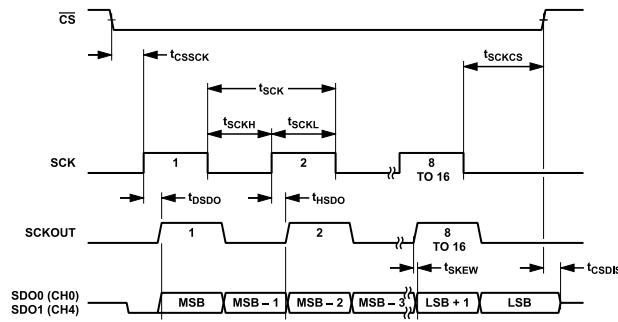

Figure 8. Echo Clock Mode Timing, DDR, 1-Lane

Table 7. Host Clock Mode Timing

Parameter	Symbol	Min	Typ	Max	Unit
SCK Period	$t_{SCKOUT}$				
OSC_DIV = No Divide		11.8	12.5	13.3	ns
OSC_DIV = Divide by 2		23.6	25	26.6	ns
OSC_DIV = Divide by 4		47.4	50	53.2	ns
SCK Low Time	$t_{SCKOUTL}$	$0.45 \times t_{SCKOUT}$		$0.55 \times t_{SCKOUT}$	ns
SCK High Time	$t_{SCKOUTH}$	$0.45 \times t_{SCKOUT}$		$0.55 \times t_{SCKOUT}$	ns
$\overline{CS}$ Falling Edge to First SCKOUT Rising Edge	$t_{DCKOUT}$				
VIO > 1.71 V		10	13.6	19	ns
VIO > 1.14 V		10	15	21	ns
Skew Between Data and SCKOUT	$t_{SKEW}$	-0.4	0	+0.4	ns
Last SCKOUT Edge to $\overline{CS}$ Rising Edge	$t_{SCKOUTCS}$	5.2			ns
$\overline{CS}$ Rising Edge to SDO High Impedance	$t_{CSDIS}$			9	ns

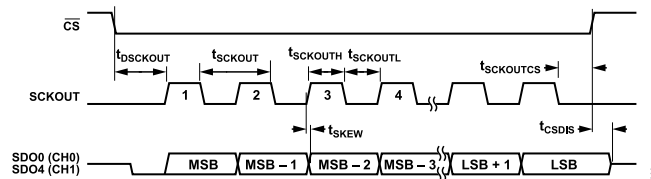

Figure 9. Host Clock Mode Timing, SDR, 1-Lane

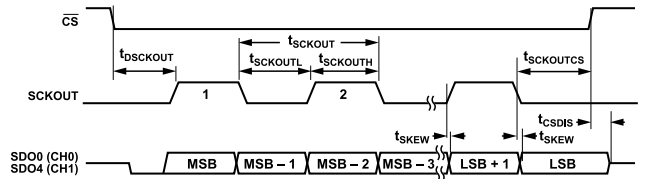

Figure 10. Host Clock Mode Timing, DDR, 1-Lane

## ABSOLUTE MAXIMUM RATINGS

**Table 8. Absolute Maximum Ratings**

Parameter	Rating
Analog Inputs IN1+, IN1-, IN0+, IN0-, REFIN to GND	-0.3V to VDD_5V + 0.3 V
Supply Voltage VDD_5V, REF to GND	-0.3 V to +6.0 V
VDD_1.8V, VIO to GND	-0.3 V to +2.1 V
Digital Inputs to GND CNV to GND	-0.3 V to VIO + 0.3 V
Digital Outputs to GND	-0.3 V to VIO + 0.3 V
Storage Temperature Range	-55°C to +150°C
Operating Junction Temperature Range	-40°C to +125°C
Maximum Reflow (Package Body) Temperature	260°C

Stresses at or above those listed under Absolute Maximum Ratings may cause permanent damage to the product. This is a stress rating only; functional operation of the product at these or any other conditions above those indicated in the operational section of this specification is not implied. Operation beyond the maximum operating conditions for extended periods may affect product reliability.

## THERMAL RESISTANCE

Thermal performance is directly linked to printed circuit board (PCB) design and operating environment. Careful attention to PCB thermal design is required.

**Table 9. Thermal Resistance**

Package Type	$\theta_{JA}$	$\theta_{JC}$	Unit
05-08-1797	35	16	°C/W

## ELECTROSTATIC DISCHARGE (ESD) RATINGS

The following ESD information is provided for handling of ESD-sensitive devices in an ESD protected area only.

Human body model (HBM) per ANSI/ESDA/JEDEC JS-001.

Field induced charged device model (FICDM) per ANSI/ESDA/JEDEC JS-002.

## ESD Ratings for AD4630-16/AD4632-16

**Table 10. AD4630-16/AD4632-16, 64-Ball CSP\_BGA**

ESD Model	Withstand Threshold (kV)	Class
HBM	4	3A
FICDM	1.25	C3

## ESD CAUTION



**ESD (electrostatic discharge) sensitive device.** Charged devices and circuit boards can discharge without detection. Although this product features patented or proprietary protection circuitry, damage may occur on devices subjected to high energy ESD. Therefore, proper ESD precautions should be taken to avoid performance degradation or loss of functionality.

## PIN CONFIGURATION AND FUNCTION DESCRIPTIONS

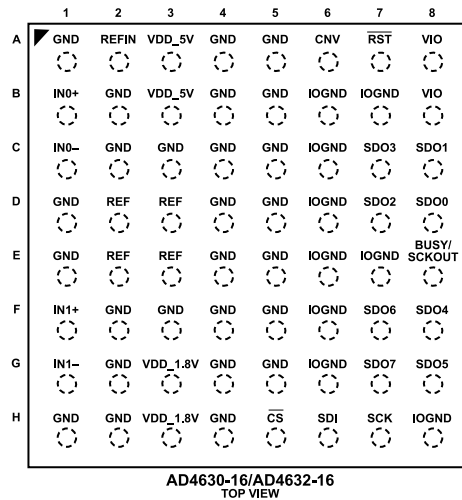

Figure 11. Pin Configuration

Table 11. Pin Function Descriptions

Pin No.	Mnemonic	Type <sup>1</sup>	Description
A1, A4, A5, B2, B4, B5, C2, C3, C4, C5, D1, D4, D5, E1, E4, E5, F2, F3, F4, F5, G2, G4, G5, H1, H2, H4	GND	P	Power Supply Ground.
A2	REFIN	AI	Buffered Reference Input. When using the internal reference buffer, drive REFIN with 4.096 V to 5 V (referred to GND). To disable the reference buffer, tie REFIN to GND and drive REF with 4.096 V to 5 V.
A3, B3	VDD_5V	P	5 V Power Supply. The range of VDD_5V depends on the reference value: 5.3 V to 5.5 V for a 5 V reference, and 4.75 V to 5.25 V for a 4.096 V reference. This pin has a 1 $\mu$ F bypass capacitor inside the package.
A6	CNV	DI	Convert Input. A rising edge on this input powers up the device and initiates a new conversion. This signal must have low jitter to achieve the specified performance of the ADC. Logic levels are determined by VIO.
A7	$\overline{\text{RST}}$	DI	Reset Input (Active Low). Asynchronous device reset.
A8, B8	VIO	P	Input/Output Interface Digital Power. Nominally, this pin is at the same supply as the host interface (1.8 V, 1.5 V, or 1.2 V). This pin has a 0.2 $\mu$ F bypass capacitor inside the package. For VIO < 1.4 V, Bit IO2X of the output driver register must be set to 1.
B1	IN0+	AI	Channel 0 Positive Analog Input.
B6, B7, C6, D6, E6, E7, F6, G6, H8	IOGND	P	VIO Ground. Connect to the same ground plane as GND.
C1	IN0-	AI	Channel 0 Negative Analog Input.
C7	SDO3	DO	Channel 0 Serial Data Output. The conversion result is output on this pin. It is synchronized to SCK.
C8	SDO1	DO	Channel 0 Serial Data Output. The conversion result is output on this pin. It is synchronized to SCK.
D2, D3, E2, E3	REF	AI	Optional Unbuffered Reference Input. Drive REF with 4.096 V to 5 V (referred to GND). This pin has a 2 $\mu$ F bypass capacitor inside the package. When using the internal reference buffer, do not connect REF.
D7	SDO2	DO	Channel 0 Serial Data Output. The conversion result is output on this pin. It is synchronized to SCK.
D8	SDO0	DO	Channel 0 Serial Data Output. The conversion result is output on this pin. It is synchronized to SCK.
E8	BUSY/SCKOUT	DO	BUSY Indicator in SPI Clocking Mode. This pin goes high at the start of a new conversion and returns low when the conversion finishes. Logic levels are determined by VIO. When SCKOUT is enabled, this pin function is either an echo of the incoming SCK from the host controller or a clock sourced by the internal oscillator.
F1	IN1+	AI	Channel 1 Positive Analog Input.
F7	SDO6	DO	Channel 1 Serial Data Output. The conversion result is output on this pin. It is synchronized to SCK.
F8	SDO4	DO	Channel 1 Serial Data Output. The conversion result is output on this pin. It is synchronized to SCK.
G1	IN1-	AI	Channel 1 Negative Analog Input.
G3, H3	VDD_1.8V	P	1.8 V Power Supply. The range of VDD_1.8V is 1.71 V to 1.89 V. This pin has a 1 $\mu$ F bypass capacitor inside the package.

**PIN CONFIGURATION AND FUNCTION DESCRIPTIONS****Table 11. Pin Function Descriptions**

Pin No.	Mnemonic	Type <sup>1</sup>	Description
G7	SDO7	DO	Channel 1 Serial Data Output. The conversion result is output on this pin. It is synchronized to SCK.
G8	SDO5	DO	Channel 1 Serial Data Output. The conversion result is output on this pin. It is synchronized to SCK.
H5	$\overline{CS}$	DI	Chip Select Input (Active Low).
H6	SDI	DI	Serial Data Input.
H7	SCK	DI	Serial Data Clock Input. When the device is selected ( $\overline{CS}$ = low), the conversion result is shifted out by this clock.

<sup>1</sup> P is power, AI is analog input, DI is digital input, and DO is digital output.

TYPICAL PERFORMANCE CHARACTERISTICS

VDD\_5V = 5.4 V, VDD\_1.8V = 1.8 V, VIO = 1.8 V, REFIN = 5 V, input common mode = 2.5 V,  $f_S = 2$  MSPS, and all specifications  $T_{MIN}$  to  $T_{MAX}$ , unless otherwise noted. Typical values are at  $T_A = 25^\circ\text{C}$ .

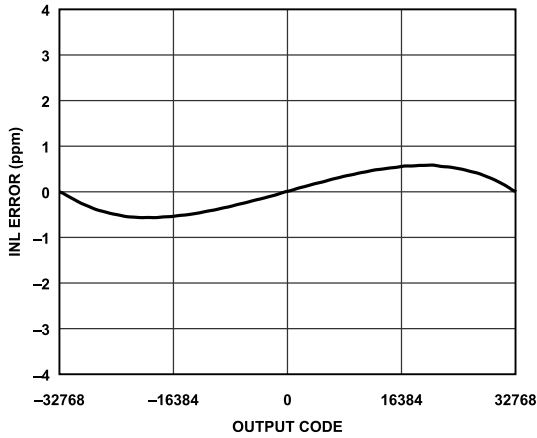

Figure 12. INL Error vs. Output Code, Differential Input

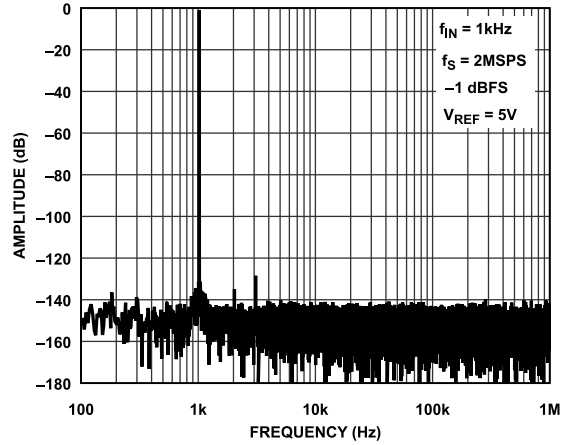

Figure 15. FFT, 2 MSPS,  $f_{IN} = 1$  kHz,  $V_{REF} = 5$  V

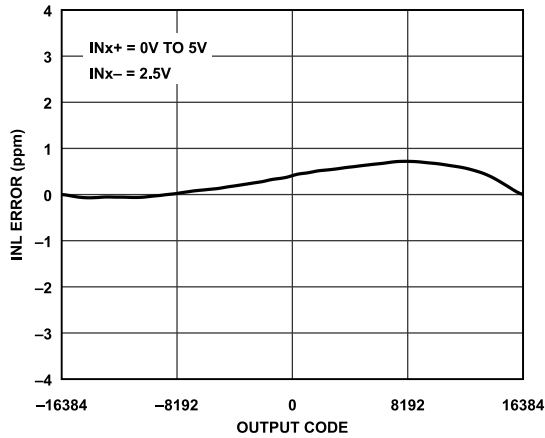

Figure 13. INL Error vs. Output Code, Single-Ended Input

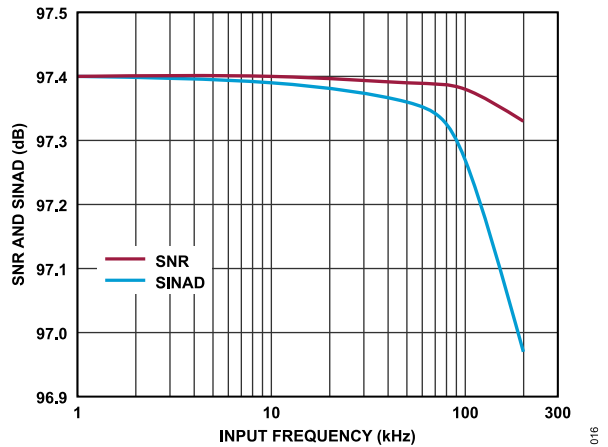

Figure 16. SNR and SINAD vs. Input Frequency

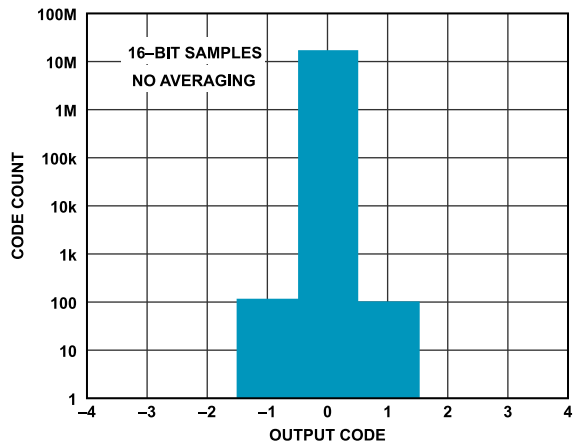

Figure 14. Code Histogram for Shorted Inputs

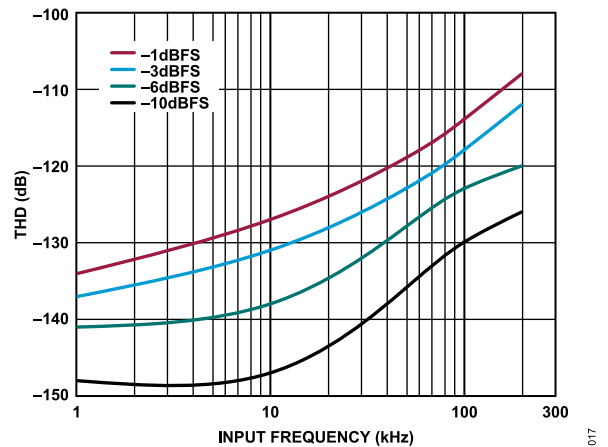

Figure 17. THD vs. Input Frequency, Various Amplitudes

TYPICAL PERFORMANCE CHARACTERISTICS

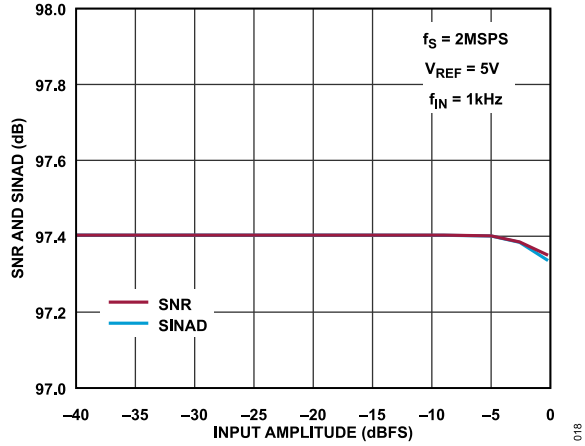

Figure 18. SNR and SINAD vs. Input Amplitude,  $f_{IN} = 1\text{ kHz}$

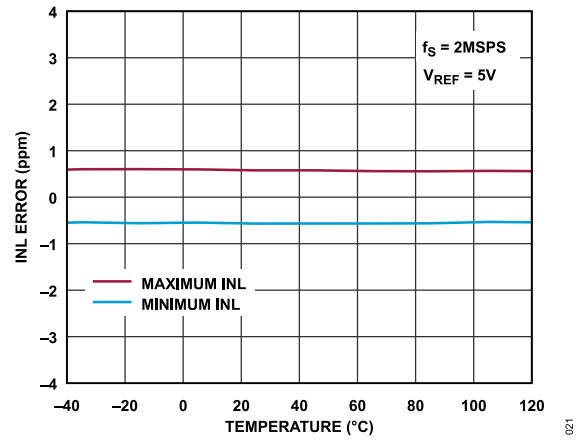

Figure 21. INL Error vs. Temperature

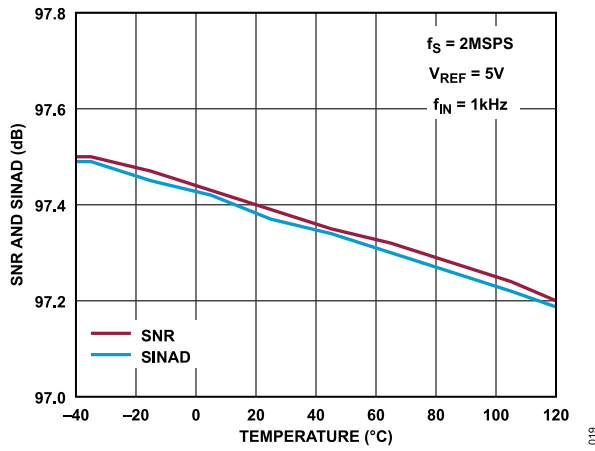

Figure 19. SNR and SINAD vs. Temperature,  $f_{IN} = 1\text{ kHz}$

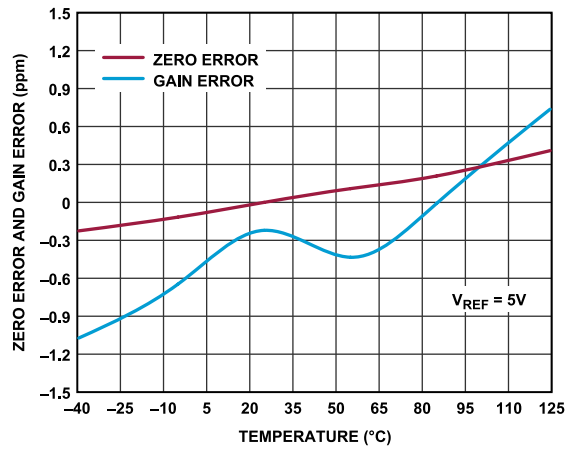

Figure 22. Zero Error and Gain Error vs. Temperature

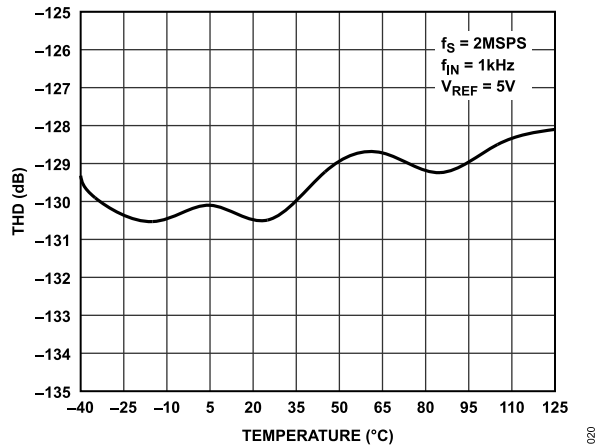

Figure 20. THD vs. Temperature,  $f_{IN} = 1\text{ kHz}$

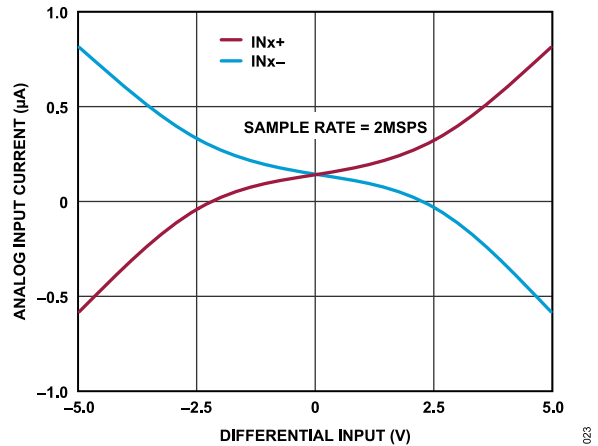

Figure 23. Analog Input Current vs. Differential Input, AD4630-16, 2 MSPS

TYPICAL PERFORMANCE CHARACTERISTICS

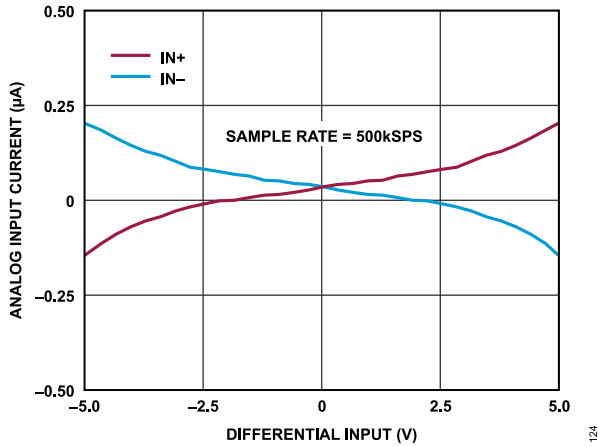

Figure 24. Analog Input Current vs. Differential Input, AD4632-16, 500 kSPS

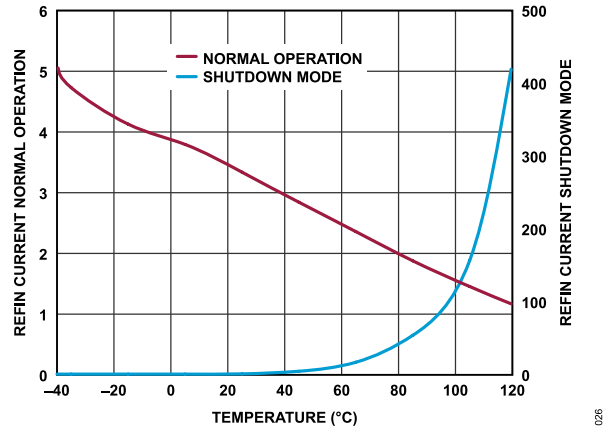

Figure 27. REF IN Current Normal Operation and REF IN Current Shutdown Mode vs. Temperature

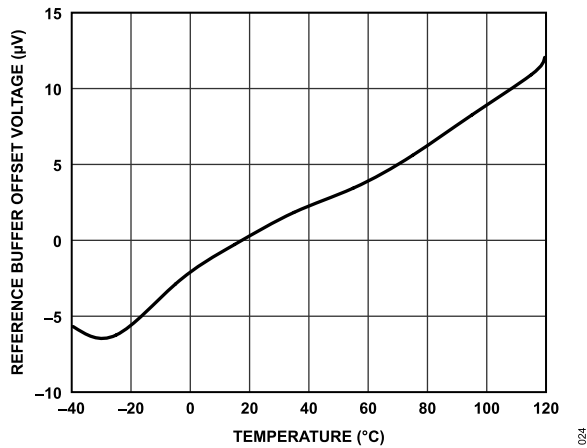

Figure 25. Reference Buffer Offset Voltage vs. Temperature

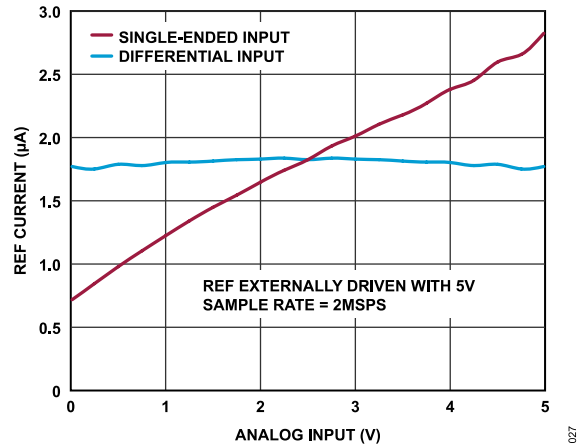

Figure 28. REF Current vs. Analog Input, AD4630-16, 2 MSPS

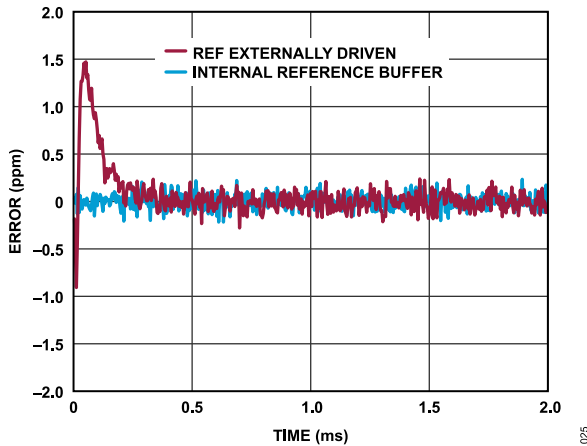

Figure 26. Error During Conversion Burst After Long Idle Time

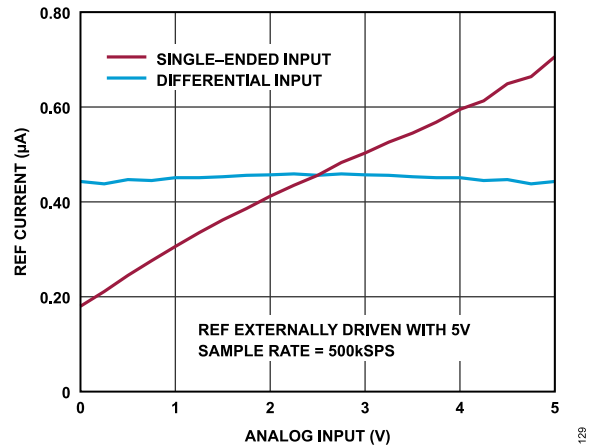

Figure 29. REF Current vs. Analog Input, AD4632-16, 500 kSPS



TYPICAL PERFORMANCE CHARACTERISTICS

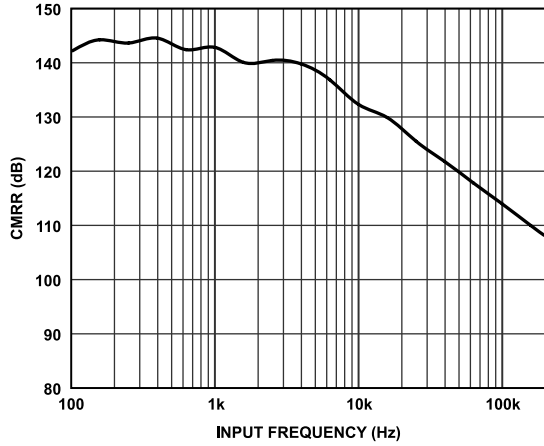

Figure 30. CMRR vs. Input Frequency

028

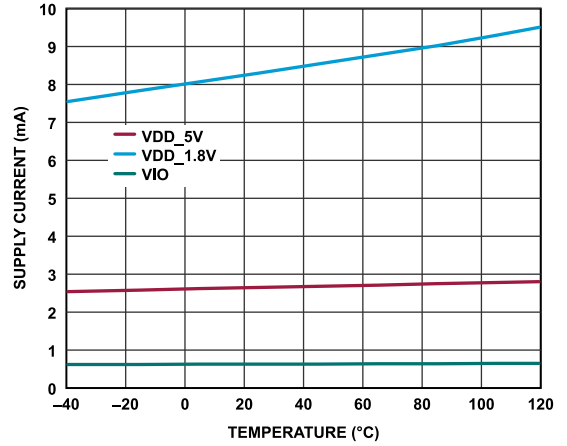

Figure 33. Supply Current vs. Temperature, AD4630-16, 2 MSPS

031

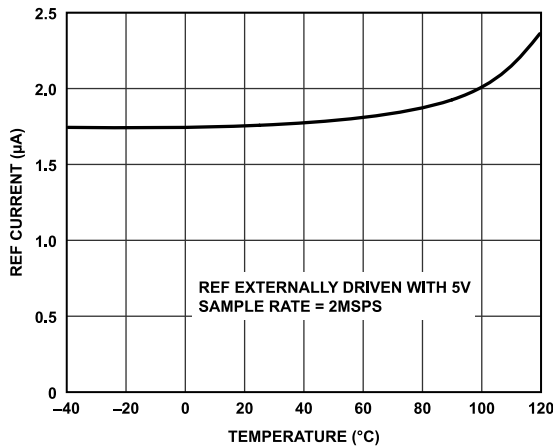

Figure 31. REF Current vs. Temperature

029

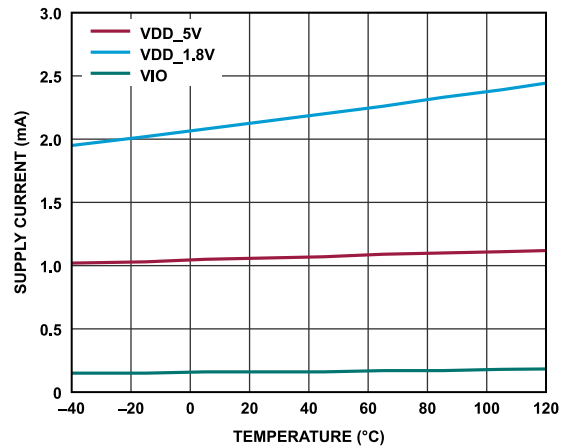

Figure 34. Supply Current vs. Temperature, AD4632-16, 500 kSPS

034

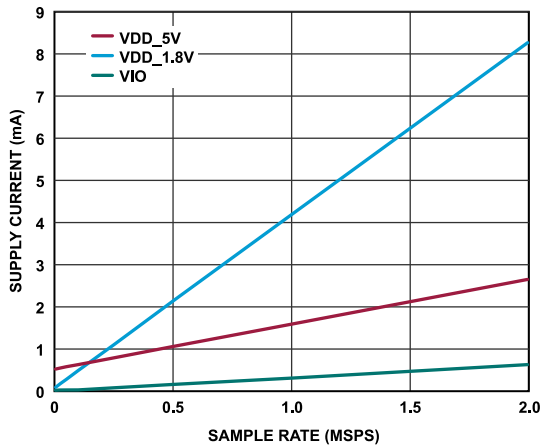

Figure 32. Supply Current vs. Sample Rate

030

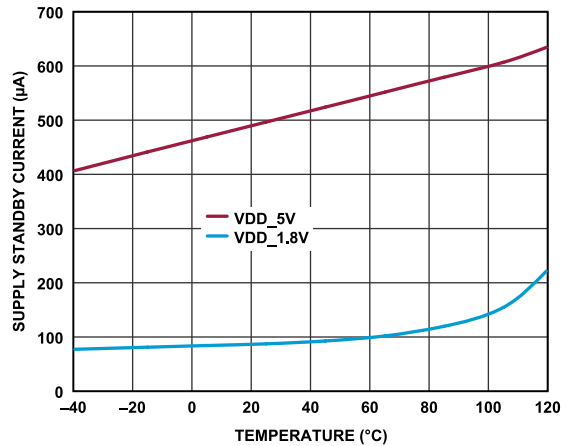

Figure 35. Supply Standby Current vs. Temperature

032

## TYPICAL PERFORMANCE CHARACTERISTICS

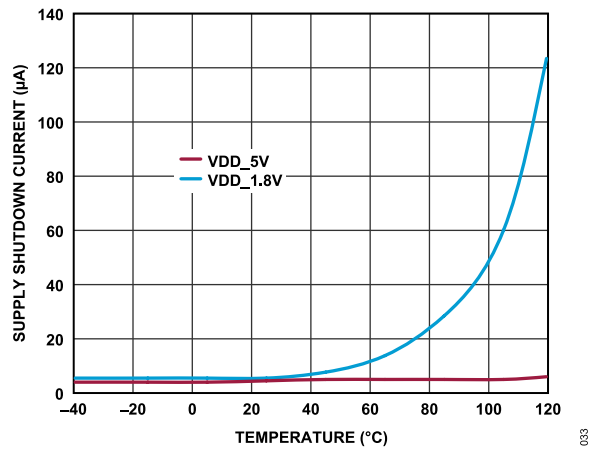

Figure 36. Supply Shutdown Current vs. Temperature

## TERMINOLOGY

### Integral Nonlinearity (INL) Error

INL is the deviation of each individual code from a line drawn from negative full scale through positive full scale. The point used as negative full scale occurs  $\frac{1}{2}$  LSB before the first code transition. Positive full scale is defined as a level  $1\frac{1}{2}$  LSB beyond the last code transition. The deviation is measured from the middle of each code to the true straight line (see [Figure 38](#)).

### Differential Nonlinearity (DNL) Error

In an ideal ADC, code transitions are 1 LSB apart. DNL is the maximum deviation from this ideal value. DNL is often specified in terms of resolution for which no missing codes are guaranteed.

### Zero Error

Zero error is the difference between the ideal midscale voltage, 0 V, and the actual voltage producing the midscale output code, 0 LSB.

### Gain Error

The first transition (from 100 ... 00 to 100 ... 01) occurs at a level  $\frac{1}{2}$  LSB above nominal negative full scale. The last transition (from 011 ... 10 to 011 ... 11) occurs for an analog voltage  $1\frac{1}{2}$  LSB below the nominal full scale. The gain error is the deviation of the difference between the actual level of the last transition and the actual level of the first transition from the difference between the ideal levels.

### Spurious-Free Dynamic Range (SFDR)

SFDR is the difference, in decibels (dB), between the rms amplitude of a full-scale input signal and the peak spurious signal.

### Effective Number of Bits (ENOB)

ENOB is a measurement of the resolution with a sine wave input. It is related to SINAD as follows:  $ENOB = (SINAD_{dB} - 1.76)/6.02$ . ENOB is expressed in bits.

### Total Harmonic Distortion (THD)

THD is the ratio of the rms sum of the first five harmonic components to the rms value of a full-scale input signal and is expressed in decibels.

### Dynamic Range

Dynamic range is the rms voltage of a full-scale sine wave to the total rms voltage of the noise measured. The value for dynamic range is expressed in decibels. It is measured with a signal at  $-60$  dBFS so that it includes all noise sources and DNL artifacts.

### Signal-to-Noise Ratio (SNR)

SNR is the ratio of the rms voltage of a full-scale sine wave to the rms sum of all other spectral components below the Nyquist frequency, excluding harmonics and dc. The value for SNR is expressed in decibels.

### Signal-to-Noise-and-Distortion (SINAD) Ratio

SINAD is the ratio of the rms voltage of a full-scale sine wave to the rms sum of all other spectral components that are less than the Nyquist frequency, including harmonics but excluding dc. The value of SINAD is expressed in decibels.

### Aperture Delay

Aperture delay is the measure of the acquisition performance and is the time between the rising edge of the CNV input and when the input signal is held for a conversion.

### Transient Response

Transient response is the time required for the ADC to acquire a full-scale input step to  $\pm 1$  LSB accuracy.

### Common-Mode Rejection Ratio (CMRR)

CMRR is the ratio of the power in the ADC output at the frequency,  $f$ , to the power of a 4.5 V p-p sine wave applied to the input common-mode voltage of frequency,  $f$ .

$$CMRR \text{ (dB)} = 10 \times \log\left(\frac{P_{ADC\_IN}}{P_{ADC\_OUT}}\right)$$

where:

$P_{ADC\_IN}$  is the common-mode power at the frequency,  $f$ , applied to the inputs.

$P_{ADC\_OUT}$  is the power at the frequency,  $f$ , in the ADC output.

### Power Supply Rejection Ratio (PSRR)

PSRR is the ratio of the power in the ADC output at the frequency,  $f$ , to the power of a 200 mV p-p sine wave applied to the ADC VDD supply of frequency,  $f$ .

$$PSRR \text{ (dB)} = 10 \times \log\left(\frac{P_{VDD\_IN}}{P_{ADC\_OUT}}\right)$$

where:

$P_{VDD\_IN}$  is the power at the frequency,  $f$ , at the VDD pin.

$P_{ADC\_OUT}$  is the power at the frequency,  $f$ , in the ADC output.

## THEORY OF OPERATION

Figure 37 shows the basic functions of the AD4630-16/AD4632-16.

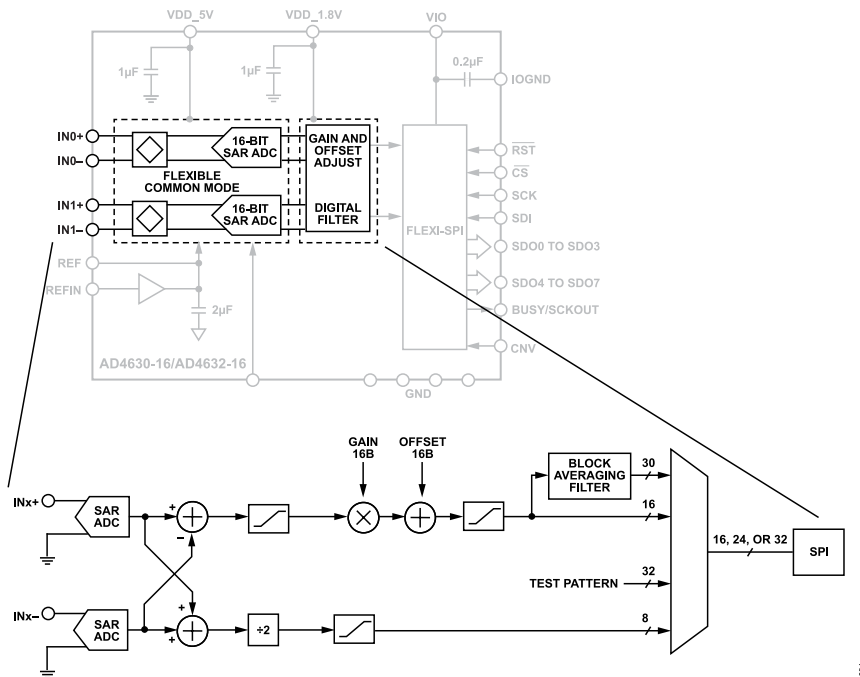

Figure 37. Functional Block Diagram and Channel Architecture

## OVERVIEW

The AD4630-16/AD4632-16 are low-noise, low-power, high-speed, dual 16-bit successive approximation register (SAR) ADCs. The AD4630-16 is capable of converting 2,000,000 samples per second (2 MSPS), and the AD4632-16 is capable of converting 500,000 samples per second (500 kSPS). The devices offer several analog and digital features to ease system design. The analog features include a wide common-mode range, which eases level-shifting requirements as well as an extended fully differential input range of  $\pm(65/64) \times V_{REF}$ , easing the margin requirements on signal conditioning.

The AD4630-16/AD4632-16 have an integrated reference buffer with an integrated decoupling capacitor to minimize the external components on board. The on-chip track-and-hold circuitry does not exhibit any pipeline delay or latency, making this circuitry ideal for control loops and high-speed applications. The digital features include offset correction, gain adjustment, and averaging, which offload the host processor. The user can configure the devices for one of several output code formats (see the [Summary of Selectable Output Data Formats](#) section).

The AD4630-16/AD4632-16 use a Flexi-SPI, allowing the data to be accessed via multiple SPI lanes, which relaxes clocking requirements for the host SPI controller. An echo clock mode is also available to assist in data clocking, simplifying the use of isolated data interfaces. The AD4630-16/AD4632-16 have a valid first conversion after exiting power-down mode. The AD4630-16/AD4632-16 achieves  $\pm 3$  ppm INL maximum, with no missing codes

at 16 bits and 97.4 dB SNR. The AD4630-16 dissipates only 15 mW per channel at 2 MSPS.

## CONVERTER OPERATION

The AD4630-16/AD4632-16 operate in two phases, acquisition and conversion. In the acquisition phase, the internal track-and-hold circuitry is connected to each input pin (INx+ and INx-) and samples the voltage on each pin independently. Issuing a rising edge pulse on the CNV pin initiates a conversion. The rising-edge pulse on the CNV pin also asserts the BUSY signal to indicate a conversion in progress. At the end of conversion, the BUSY signal is deasserted. The conversion result is a 16-bit code representing the input voltage difference and an 8-bit code representing the input common-mode voltage. Depending on the device configuration, this conversion result can be processed digitally and latched into the output register. The acquisition circuit on each input pin is also precharged to the previous sample voltage, which minimizes the kick-back charge to the input driver. The host processor retrieves the output code by the SDOx pins that are internally connected to the output register.

## TRANSFER FUNCTION

In the default configuration, the AD4630-16/AD4632-16 digitize the full-scale difference voltage of  $2 \times V_{REF}$  into  $2^{16}$  levels, resulting in an LSB size of  $152.6 \mu\text{V}$  with  $V_{REF} = 5 \text{ V}$ . Note that 1 LSB at 16 bits is approximately 15.26 ppm. The ideal transfer function is shown in [Figure 38](#). The differential output data is in twos complement

## THEORY OF OPERATION

format. Table 12 summarizes the mapping of input voltages to differential output codes.

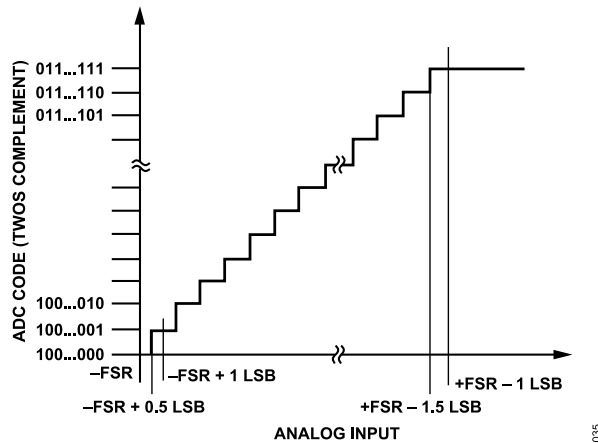

Figure 38. ADC Ideal Transfer Function for the Differential Output Codes (FSR Is Full-Scale Range)

Table 12. Input Voltage to Output Code Mapping

Description	Analog Input Voltage Difference	Digital Output Code (Twos Complement, Hex)
FSR - 1 LSB	$(32767 \times V_{REF})/(32768)$	0x7FFF
Midscale + 1 LSB	$V_{REF}/(32768)$	0x0001
Midscale	0 V	0x0000
Midscale - 1 LSB	$-V_{REF}/(32768)$	0xFFFF
-FSR + 1 LSB	$-(32767 \times V_{REF})/(32768)$	0x8001
-FSR	$-V_{REF}$	0x8000

## ANALOG FEATURES

The AD4630-16/AD4632-16 have a precharging circuit as a part of the internal track-and-hold circuitry, which charges the internal sampling capacitors to the previously sampled input voltage. This circuit reduces the charge kickback, making it easier to drive than other conventional SAR ADCs. The reduced kickback, combined with a longer acquisition phase, means reduced settling requirements on the driving amplifier. This combination also allows the use of larger resistor values, which are beneficial for improving amplifier stability. Furthermore, the bandwidth of the RC filter is reduced, resulting in lower noise and/or power consumption of the signal chain.

The common-mode voltage is not restricted except by the absolute voltage range for each input (from  $-1/128 \times V_{REF}$  to  $129/128 \times V_{REF}$ ). The analog inputs can be modeled by the equivalent circuit shown in Figure 39. In the acquisition phase, each input sees approximately 58 pF input capacitance ( $C_{IN}$ ) from the sampling capacitor in series with the 37  $\Omega$  on resistance ( $R_{ON}$ ) of the sampling switch. During the conversion phase, each input has the capacitance of the input pin ( $C_{PIN}$ ), which is about 2 pF. Any signal that is common to both inputs is reduced by the common-mode rejection of the ADC. During the conversion, the analog inputs draw only a small leakage current.

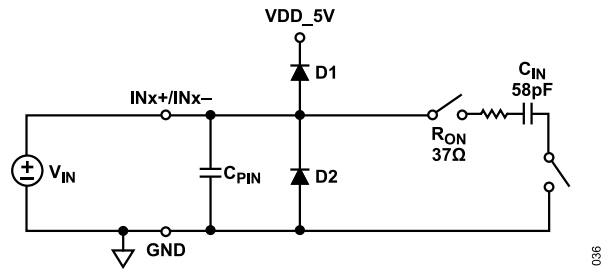

Figure 39. Equivalent Circuit for the AD4630-16/AD4632-16 Differential Analog Input

Each input is sampled independently. The conversion results do not saturate assuming each of the inputs are within the specified full-scale input range. Note that digital domain saturation occurs if the digital offset and digital gain parameters are configured to map the conversion result to numeral values that exceed the full-scale digital range ( $-2^{15}$  to  $+2^{15} - 1$  for the 16-bit word). An input voltage difference up to  $\pm(65/64) \times V_{REF}$  can be captured and converted without saturation by setting the digital gain parameter to a value  $< 1$ .

The slew rate at the analog input pins must be less than 400 V/ $\mu$ s during the acquisition phase and less than 30 V/ $\mu$ s at the sampling moment to ensure good performance. This performance can be ensured by choosing values for the external RC circuit that allow the RC time constant to be more than 12.5 ns ( $R \times C > 12.5^9$ ).

## DIGITAL SAMPLE PROCESSING FEATURES

The AD4630-16/AD4632-16 support several digital and data processing features that can be applied to the signal samples. These features are enabled and disabled by the control registers of the AD4630-16/AD4632-16. Figure 37 contains an ADC channel architecture block diagram showing the digital and data processing features available for each input channel.

### Full-Scale Saturation

The conversion results saturate digitally (before any postprocessing) when either or both inputs exceed the analog limits specified within. After applying offset and gain scaling, the results are truncated to 16-bit representation (saturating at maximum 0x7FFF and minimum 0x8000). Care must be taken to avoid unintentional saturation, especially when applying digital offset and/or gain scaling. See the [Digital Offset Adjust](#) and [Digital Gain](#) sections for more details on the use of these features.

### Common-Mode Output

When the host controller writes 0x1 to the OUT\_DATA\_MD bit field of the modes register (see the [Modes Register](#) section), an 8-bit code representing the input common-mode voltage is appended to the 16-bit code representing the input voltage difference. The LSB size of the 8-bit code is  $V_{REF}/256$ . The 8-bit code saturates at 0 and 255 when the common-mode input voltage is 0 V and  $V_{REF}$ ,

**THEORY OF OPERATION**

respectively. The 8-bit code is not affected by digital offset and gain scaling, which is applied only to the code representing the input voltage difference.

**Block Averaging**

The AD4630-16/AD4632-16 provide a block averaging filter (SINC1) with a programmable block length of  $2^N$ , where  $N = 0, 1, 2, 3, \dots, 16$ . The filter is reset after processing each block of  $2^N$  samples. The filter is enabled by writing 0x3 to the OUT\_DATA\_MD bit field of the modes register (see the [Modes Register](#) section) as well as a value ( $1 \leq N \leq 16$ ) to the AVG\_VAL bit field in the averaging mode register (see the [Averaging Mode Register](#) section). In this configuration, the output sample word is 32 bits. The 30 MSBs represent the numerical value of the 16-bit codes averaged in blocks of  $2^N$  samples. The 16 MSBs of the 30-bit code are equal to the 16-bit codes when averaging blocks of constant values. The 31<sup>st</sup> bit (OR) is an overrange warning bit, which is high when one or more samples in the block are subject to saturation. The 32<sup>nd</sup> bit (SYNC) is high once every  $2^N$  conversion cycles to indicate when the average values are updated at the end of each block of samples. See the [Summary of Selectable Output Data Formats](#) section for the data format when the filter is enabled.

The effective data rate in averaging mode is the CNV frequency ( $f_{CNV}$ )/ $2^N$ . The reset value of N in the AVG\_VAL bit field is 0x00 (no averaging). [Figure 54](#) shows an example timing diagram in averaging mode. [Figure 40](#) shows the frequency response of the filter for an  $N = 1, 2, 3, 4, 5$ .

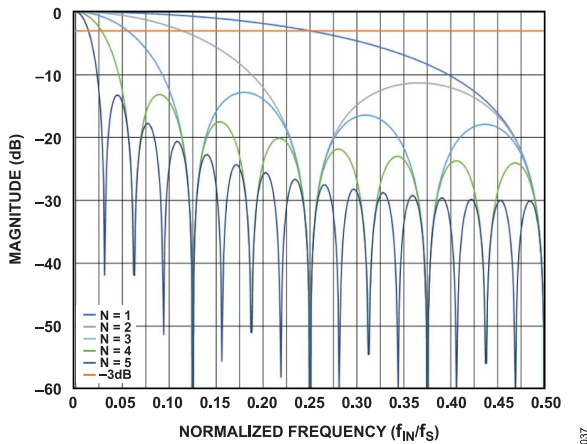

Figure 40. Frequency Response Examples for the Block Averaging Filter

**Digital Offset Adjust**

Each ADC channel can be programmed independently to add a 16-bit signed offset value to the sample data (see the [Register Details](#) section). When adding an offset to the samples, it is possible to cause the sample data to saturate numerically. The user must take this into account when using the offset feature. The default value is 0x0000. See the [Channel 0 Offset Registers](#) section or [Channel 1](#)

[Offset Registers](#) section in the AD4630-16/AD4632-16 register map for more details.

**Digital Gain**

Each ADC channel can be programmed independently to apply a 16-bit unsigned digital gain (CHx\_USER\_GAIN) to the digital samples (see the [Register Details](#) section). The gain is applied to each sample based on the following equation:

$$\text{Code}_{\text{OUT}} = \text{Code}_{\text{IN}} \times (\text{CHx\_USER\_GAIN}/0x8000)$$

where  $0x0000 \leq \text{CHx\_USER\_GAIN} \leq 0xFFFF$ .

The effective gain range is 0 to 1.99997. Note that applying gain to the samples may cause numerical saturation. The default value is 0x8000 (gain = 1). To measure input voltage differences exceeding  $\pm V_{\text{REF}}$ , set the gain below unity to avoid the numerical saturation of the 16-bit or 30-bit output differential codes. See the [Channel 0 Gain Registers](#) section or [Channel 1 Gain Registers](#) section in the AD4630-16/AD4632-16 register map for more details.

**Test Pattern**

To facilitate functional testing and debugging of the SPI, the host controller can write a 32-bit test pattern to the AD4630-16/AD4632-16 (see the [Test Pattern Registers](#) section). The value written to the test pattern registers applies to both ADC channels, and is output using the normal sample cycle timing on each channel. The 32-bit test pattern output mode is enabled by writing 0x4 to the OUT\_DATA\_MD bit field of the modes register (see the [Modes Register](#) section). The default value stored in the test pattern registers is 0x5A5A0F0F.

**Summary of Selectable Output Data Formats**

[Figure 41](#) summarizes the output data formats that are available on the AD4630-16/AD4632-16, which are selected in the modes register (see the [Modes Register](#) section). Note that the selected mode is applied to both channels. Note: OR and SYNC flags are each 1-bit.

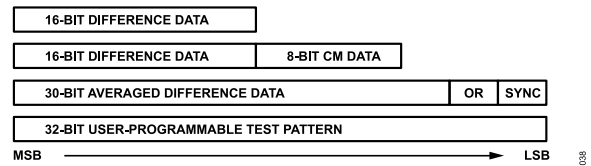

Figure 41. Summary of Selectable Output Sample Formats

## APPLICATIONS INFORMATION

## TYPICAL APPLICATION DIAGRAM

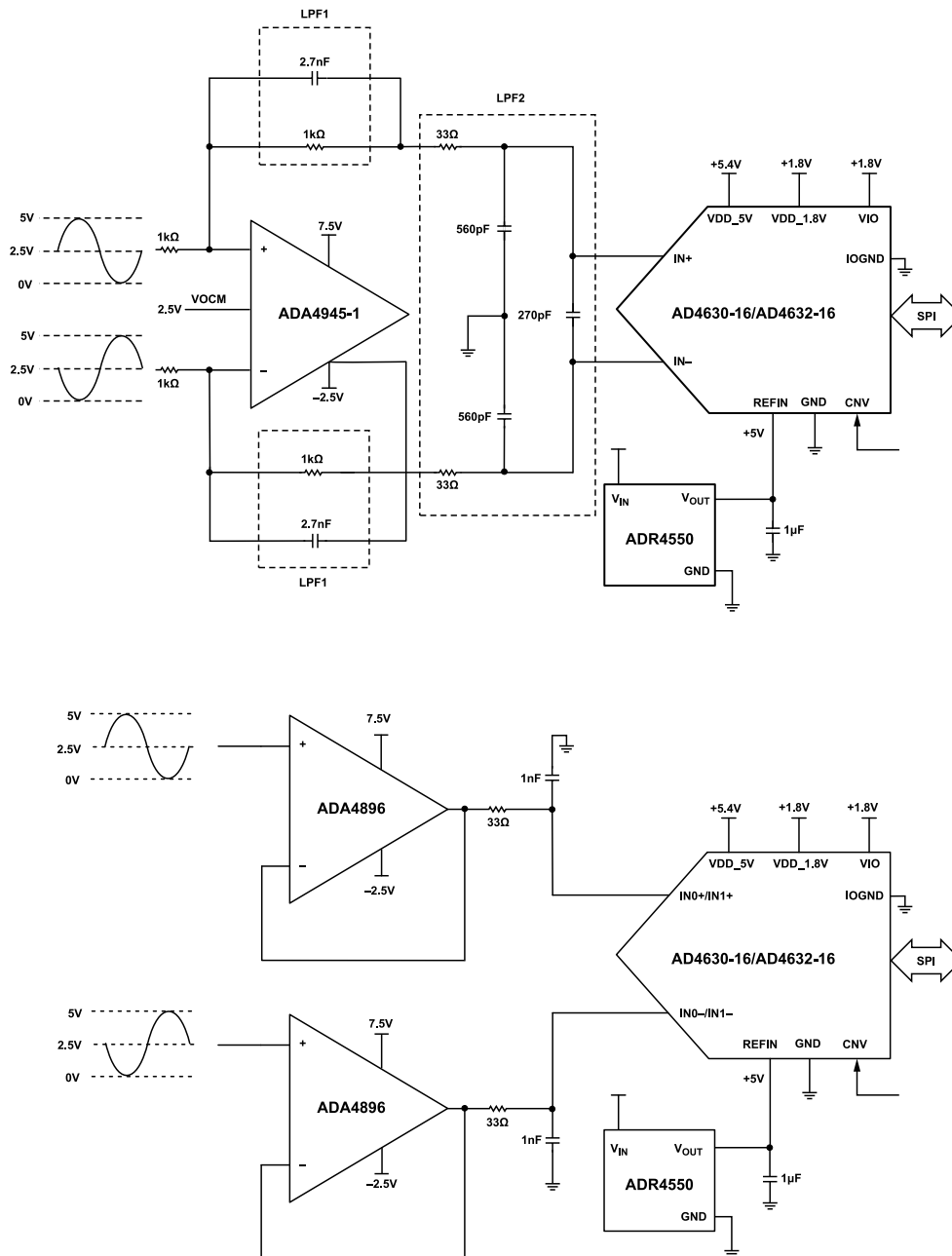

Figure 42. Typical Application Diagram

## ANALOG FRONT-END DESIGN

## Driver Amplifier Choice

Figure 42 shows two examples for driving the AD4630-16/AD4632-16. Either can be combined with an upstream stage that provides additional signal conditioning. Both examples can accommodate single-ended or differential inputs. To take advantage of the SNR and THD performance of the AD4630-16/AD4632-16, choose a driver amplifier that has low noise and THD sufficient to meet

the application requirements. In addition to the amplifiers shown in Figure 42, the LTC6227 is another driver option. Analog Devices, Inc., offers several companion driver amplifiers that can be found on the [ADC drivers](#) web page.

## REFERENCE CIRCUITRY DESIGN

The AD4630-16/AD4632-16 require an external reference to define their input range. This reference must be 4.096 V to 5 V. An optimal choice for the reference is the [ADR4550](#) or [ADR4540](#). The ADC has several features that reduce the charge pulled from

## APPLICATIONS INFORMATION

the reference, making the AD4630-16/AD4632-16 much easier to use than other ADCs. For most applications, the reference can drive the REF<sub>IN</sub> pin, which has an internal precision buffer that isolates the reference from the ADC circuitry. The buffer has a high input impedance and small input current (5 nA typical) that allows multiple ADCs to share a common reference. An RC circuit between the reference and REF<sub>IN</sub> can be used to filter reference noise (see Figure 43). The suggested values are  $100\ \Omega < R < 1\ \text{k}\Omega$  and  $C \geq 10\ \mu\text{F}$ .

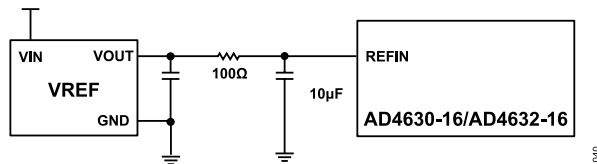

Figure 43. Reference with Noise Filter

For the best possible gain error, the internal buffer can be disabled (REF<sub>IN</sub> = 0 V) and an external reference can be used to drive the



Figure 44. CNV Waveform Showing Burst Sampling

REF pin. The current drawn by the REF pin is small (<2 μA) and depends on the sample rate and output code (see Figure 28). An internal 2 μF capacitor on the REF pin provides optimal reference bypassing and simplifies PCB design by reducing component count and layout sensitivity.

In applications where a burst of samples is taken after idling for long periods, as shown in Figure 44, the reference current ( $I_{\text{REF}}$ ) quickly goes from approximately 0 μA to a maximum of 1.8 μA at 2 MSPS. This step in DC current draw triggers a transient response in the reference that must be considered because any deviation in the reference output-voltage affects the accuracy of the output code. If the reference is driving the REF<sub>IN</sub> pin, the internal buffer is able to handle these transitions (see Figure 26). When the REF pin is being driven with no external buffer, and the transient response of the reference is important, the fast settling LTC6655LN-5 reference is recommended.



## APPLICATIONS INFORMATION

### DEVICE RESET

The AD4630-16/AD4632-16 provide two options for performing a device reset using the serial interface. A hardware reset is initiated by pulsing the voltage on the  $\overline{\text{RST}}$  pin low. A software reset is initiated by setting both the  $\text{SW\_RESET}$  and  $\text{SW\_RESETX}$  bits in the Interface Configuration A register to 1 in the same write instruction (see the [Interface Configuration A Register](#) section).

Performing a hardware or software reset asserts the  $\text{RESET\_OCCURRED}$  bit in the digital diagnostics register (see the [Digital Diagnostics Register](#) section). The  $\text{RESET\_OCCURRED}$  bit is cleared by writing it with a 1.  $\text{RESET\_OCCURRED}$  can be used by the digital host to confirm the AD4630-16/AD4632-16 executed a device reset.

The AD4630-16/AD4632-16 are designed to generate a power-on reset (POR) when  $\text{VDD\_5V}$  and  $\text{VDD\_1.8V}$  are first applied. A POR resets the state of the user configuration registers and asserts the  $\text{RESET\_OCCURRED}$  bit. If  $\text{VDD\_5V}$  or  $\text{VDD\_1.8V}$  drops below its specified operating range, a POR occurs. It is recommended to perform a hardware or software reset after a POR.

[Figure 45](#) shows the timing diagram for performing a device reset using the  $\overline{\text{RST}}$  input. The minimum  $\overline{\text{RST}}$  pulse width is 50 ns, represented by  $t_{\text{RESET\_PW}}$  in [Figure 45](#) and [Table 1](#). A reset must be performed no sooner than 3 ms after the power supplies are valid and stable (this delay is represented by  $t_{\text{RESET\_DELAY}}$  in [Figure 45](#) and [Table 1](#)).

After a hardware or software reset, no SPI commands or conversions can be started for 750  $\mu\text{s}$ .

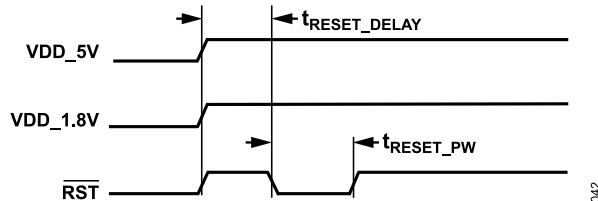

Figure 45. Power-On Reset (POR) Timing

### POWER SUPPLIES

The AD4630-16/AD4632-16 do not have any specific power supply sequencing requirements. Care must be taken to adhere to the maximum voltage relationships described in the [Absolute Maximum Ratings](#) section. The voltage range for the  $\text{VDD\_5V}$  supply depends on the chosen reference voltage (see the internal reference buffer or externally overdriven reference specifications in [Specifications](#)). [Figure 46](#) shows the minimum and maximum values for  $\text{VDD\_5V}$  with respect to  $\text{REFIN}$  and  $\text{REF}$ . The  $\text{VDD\_5V}$  voltage values above the maximum or below the minimum result in either damage to the device or degraded performance.

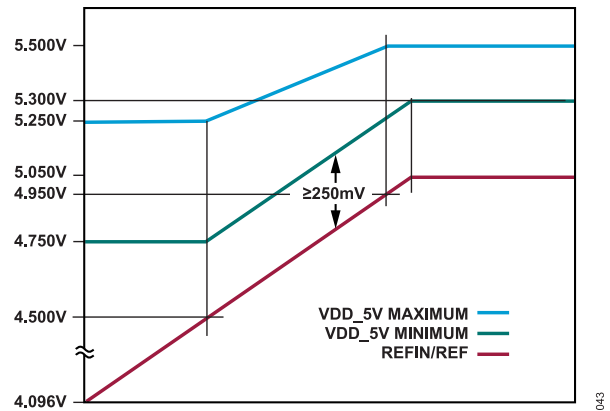

Figure 46.  $\text{VDD\_5V}$  Minimum and Maximum Values for  $\text{REFIN/REF}$

The AD4630-16/AD4632-16 have a POR circuit that resets the AD4630-16/AD4632-16 at initial power-up or whenever  $\text{VDD\_5V}$  or  $\text{VDD\_1.8V}$  drops below its specified operating range.

Note that the  $\text{VDD\_5V}$  and the  $\text{VDD\_1.8V}$  supplies have internal 1  $\mu\text{F}$  bypass capacitors inside the package, while  $\text{VIO}$  has an internal 0.2  $\mu\text{F}$  bypass capacitor. These internal capacitors reduce bill of materials (BOM) count and solution size. If the bulk supply bypass capacitors are not close to the ADC, external capacitors can be added next to the ADC. The minimum rise time for all supplies is 100  $\mu\text{s}$ .

### Power Consumption States

During a conversion, the power consumption rate of the AD4630-16/AD4632-16 is at its highest. When the conversion is complete, the devices enter a standby state and much of the internal circuitry is powered down, and current consumption drops to less than 20% relative to the conversion state. To ensure full accuracy, some circuitry, including the reference buffer, remains powered on during the standby state.

The devices can be placed into a lower power shutdown state during periods when the convert clock is idle by writing 0x3 to the  $\text{OPERATING\_MODES}$  bit field of the device configuration register (see the [Device Configuration Register](#) section). The default value of this bit field is 00 for normal operating mode. In the shutdown state, the current consumption typically drops to less than 10  $\mu\text{A}$ .

### Shutdown Mode

When the user enters shutdown mode, the internal reference buffer is disabled and a 500  $\Omega$  switch connects  $\text{REFIN}$  to  $\text{REF}$  (unless  $\text{REFIN}$  is grounded and  $\text{REF}$  is externally driven), which keeps the 2  $\mu\text{F}$  capacitor on  $\text{REF}$  charged up to allow fast recovery when the user leaves shutdown mode. Because of this keep-alive switch, some charge injects to  $\text{REFIN}$  when the user enters shutdown mode (400 pC) and leaves shutdown mode (5 pC). When leaving shutdown mode,  $\text{REF}$  is accurate after 30  $\mu\text{s}$ .

## SERIAL INTERFACE

The AD4630-16/AD4632-16 support a multilane SPI serial digital interface for each channel with a common bit clock (SCK). The flexible VIO supply allows the AD4630-16/AD4632-16 to communicate with any digital logic operating between 1.2 V and 1.8 V. However, for VIO levels below 1.4 V, the IO2X bit in the output driver register must be set to 1 (see the [Output Driver Register](#) section). The serial output data is clocked out on up to four SDO lanes per channel (see [Figure 47](#)). An echo clock mode that is synchronous with the output data is available to ease timing requirements when using isolation on the digital interface. A host clock mode is also available and uses an internal oscillator to clock out the data bits. The [SPI Clocking Mode](#) section, [Echo Clock Mode](#) section, [Host Clock Mode](#) section, [Single Data Rate](#) section, [Dual Data Rate](#) section, [1-Lane Output Data Clocking Mode](#) section, [2-Lane Output Data Clocking Mode](#) section, [4-Lane Output Data Clocking Mode](#) section, and [Data Output Modes Summary](#) section describe the operation of the SPI of the AD4630-16/AD4632-16.

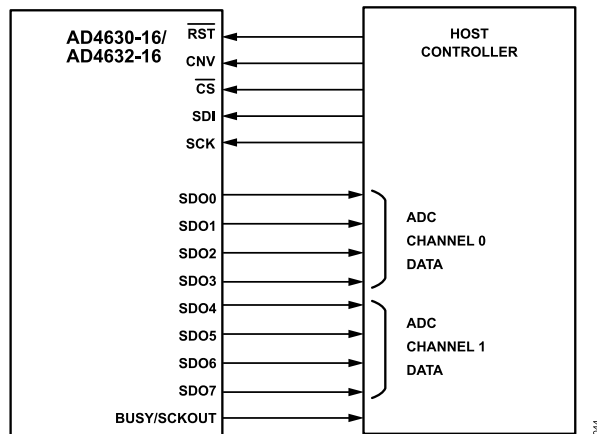

Figure 47. Multilane SPI

### SPI SIGNALS

The SPI is a multilane interface that is used to both configure the ADC as well as retrieve sampled data. The SPI consists of the following signals:

- ▶  $\overline{CS}$  (input). Chip select.  $\overline{CS}$  must be set low to initiate and enable a data transfer to and from the SDI pin or SDOx pins of the ADC.  $\overline{CS}$  timing for reading sample data can be moderated by observing the state of the BUSY pin. For echo clock mode and host clock mode,  $\overline{CS}$  timing must be controlled by the host processor because the BUSY pin is used as the bit clock output for these clocking modes.
- ▶ SDI (input). Serial data input stream from the host controller to ADC. SDI is only used when writing data into one of the user registers of the AD4630-16/AD4632-16.
- ▶ CNV (input). The CNV signal is sourced by the host controller and initiates a sample conversion. The frequency of CNV signal determines the sampling rate of the AD4630-16/AD4632-16. The maximum frequency of the CNV clock is 2 MSPS.
- ▶ SCK (input). Serial data clock sourced by the host controller. The maximum supported SCK rate for output data transfer is 100 MHz. For register reads and writes, the maximum SCK rate is 86 MHz for  $VIO > 1.71$  V, and 81 MHz for  $1.14V \leq VIO < 1.71$  V.
- ▶ SDO0 through SDO7 (outputs). Data lanes to the host controller. The SDO0 to SDO3 lanes are allocated to ADC Channel 0, whereas the SDO4 to SDO7 lanes are allocated to ADC Channel 1. The number of data lanes configured for each channel can be 1, 2, or 4 lanes (see [Table 14](#)). The number of data lanes is configured in the modes register. Note that the selected number of data lanes is applied to both ADC channels. The channels cannot be configured independently.
- ▶ BUSY/SCKOUT (output). The behavior of the BUSY/SCKOUT pin is dependent on the selected clocking mode. [Table 13](#) defines the behavior of the BUSY/SCKOUT pin for each clocking mode.

Table 13. BUSY/SCKOUT Pin Behavior vs. Clocking Mode

Clocking Mode	Behavior
SPI	Valid BUSY signal for the ADC conversion status. BUSY goes high when a conversion is triggered by the CNV signal. BUSY goes low when the conversion is complete.
Echo	Bit clock. BUSY/SCKOUT is a delayed version of SCK input.
Host	Bit clock. BUSY/SCKOUT sources the clock from the internal oscillator.

### Register Access Mode

The AD4630-16/AD4632-16 offer programmable user registers that are used to configure the device as outlined in the [Registers](#) section. By default, at power-up, the device is in conversion mode. Therefore, to access the user registers, a special access command must be sent by the host controller over the SPI, as shown in [Figure 5](#). When this register access command is sent over the SPI, the device enters the register configuration mode. To read back the values from one of the user registers listed in the [Registers](#) section, the host controller must send the pattern shown in [Figure 4](#). To write to one of the user registers, the host controller must send the pattern shown in [Figure 3](#). In either case (read/write), the host controller must always issue 24 clock pulses on the SCK line and pull  $\overline{CS}$  low for the entire transaction.

After writing to/reading from the appropriate user registers, the host controller must exit the register configuration mode by writing 0x01 to Register Address 0x0014 as detailed in the exit configuration mode register. An algorithm for register read/write access is as follows:

1. Perform a read back from a dummy Register Address 0x3FFF to enter the register configuration mode.
2. Read back from or write to the desired user register addresses.
3. Exit the register configuration mode by writing 0x01 to Register Address 0x0014. Exiting register configuration mode causes the register updates to take effect.

**SERIAL INTERFACE**

**Stream Mode**

The AD4630-16/AD4632-16 also offer a way to perform bulk register read/write transactions while the AD4630-16/AD4632-16 are in register configuration mode. To perform bulk read/write registers transactions,  $\overline{CS}$  must be kept low and SCK pulses must be issued in multiples of 8 as each register is only one byte (8 bits) wide. In stream mode, only address decrementing is allowed, meaning that the user can read back from/write to the initial register address and register addresses that are directly below the initial register address. It is recommended that register accesses in stream mode

be applied to register blocks with contiguous addresses. However, it is possible to address registers that are not present in the register map. To do so, simply write all zeros to these registers, or, when reading back, simply discard the contents read from these registers, because it is random data. See the [Registers](#) section to see which register address is valid and continuous. For example, to read back a 16-bit offset value in one shot, the user must issue 16 SCK pulses starting from Register Address 0x0018. [Figure 48](#) shows the timing diagram for a bulk read starting at a given address.

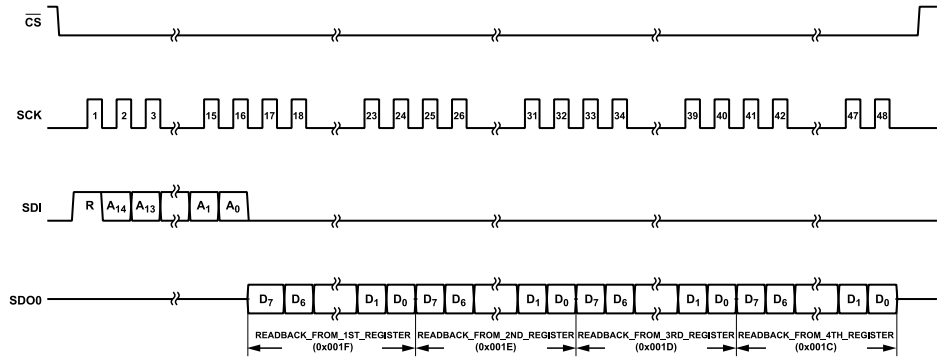

**Figure 48. Stream Mode Bulk Register Read Back Operation**

SERIAL INTERFACE

SAMPLE CONVERSION TIMING AND DATA TRANSFER

A conversion starts on the rising edge of the CNV signal, as shown in Figure 49. Once the conversion is complete,  $\overline{CS}$  can be asserted, which causes the current conversion result to load into the output shift register.

Referring to Figure 49, there are two optional data transfer zones for Sample N. Zone 1 represents the use case where  $\overline{CS}$  is asserted immediately following the deassertion of BUSY signal for the Sample N conversion (in SPI conversion mode), or after 300 ns for echo and host clock modes. For Zone 1, the available time to read out Sample N is given by:

$$\text{Zone 1 Data Read Window} = t_{CYC} - t_{CONV} - t_{QUIET\_CNV\_ADV}$$

For example, if  $f_{CNV}$  is 2 MSPS ( $t_{CYC} = 500$  ns) and using the typical value of  $t_{CONV}$  (282 ns), the available window width is 198.4 ns ( $500$  ns -  $282$  ns -  $19.6$  ns).

Zone 2 represents the case where the assertion of  $\overline{CS}$  to read Sample N is delayed until after the conversion for Sample N + 1 initiates.

To prevent data corruption, a quiet zone must be observed before and after each rising edge of the CNV signal, as shown in Figure 49. The quiet zone immediately before the rising edge of CNV is labeled as  $t_{QUIET\_CNV\_ADV}$ , and is equal to 19.6 ns. The quiet zone immediately after the rising edge of CNV is labeled  $t_{QUIET\_CNV\_DELAY}$ , and is equal to 9.8 ns. Assuming that  $\overline{CS}$  is asserted immediately after the quiet zone around the rising edge of CNV, the amount of time available to clock out the data is:

$$\text{Zone 2 Data Read Window} = t_{CYC} - t_{QUIET\_CNV\_DELAY} - t_{QUIET\_CNV\_ADV}$$

For example, if  $f_{CNV}$  is 2 MSPS ( $t_{CYC} = 500$  ns) and using the typical value of  $t_{CONV}$  (282 ns), the available window width is 470.6 ns ( $500$  ns -  $9.8$  ns -  $19.6$  ns). The Zone 2 transfer window is longer than the Zone 1 window, which can enable the use of a slower SCK on the SPI and ease the timing requirements for the interface. When using Zone 2 for the data transfer, it is recommended to assert  $\overline{CS}$  immediately after the quiet zone. However,  $\overline{CS}$  must be asserted at least 25 ns before the falling edge of BUSY for Sample N + 1. If not, Sample N is overwritten with Sample N + 1.

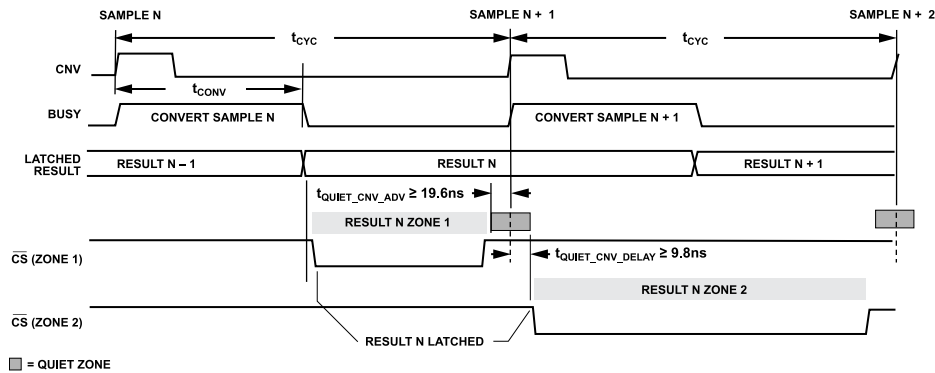

Figure 49. Example Timing for Data Transfer Zones

## SERIAL INTERFACE

## CLOCKING MODES

This section covers the various clocking modes supported by the SPI of the AD4630-16/AD4632-16. These modes are available for 1-lane, 2-lane, 4-lane, and interleaved configurations. The clocking mode is configured in the modes register (see [Table 16](#) for register descriptions). Note that the selected clocking mode applies to both ADC channels. The ADC channels cannot be configured independently.

## SPI Clocking Mode

SPI clocking mode is the default clocking mode of the AD4630-16/AD4632-16 and is equivalent to a host-sourced bit clock (SCK), in which the host controller uses its own clock to latch the output data.

The SPI compatible clocking mode is enabled by writing 0x0 to the CLK\_MD bit field of the modes register (see the [Modes Register](#) section). The interface connection is as shown in [Figure 47](#). In this mode, the BUSY signal is valid, and indicates the completion of a conversion (high-to-low transition of BUSY). A simplified sample cycle is shown in [Figure 50](#). When not in averaging mode, if the host controller does not use the BUSY signal to detect the completion of a conversion, and instead uses an internal timer to retrieve the data, the controller must wait at least 300 ns after the rising edge of the CNV pulse before asserting  $\overline{CS}$  low. When operating in block averaging mode, the host controller must assert  $\overline{CS}$  low no sooner than 300 ns after the rising edge of the CNV pulse for the last sample in the block.

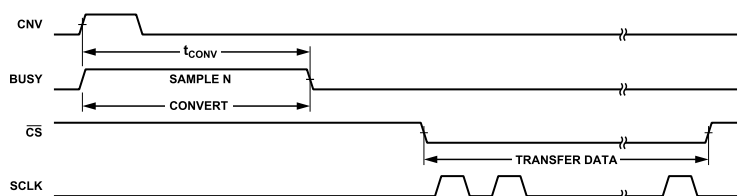

Figure 50. Typical Sample Cycle for SPI Clocking Mode

## SERIAL INTERFACE

## Echo Clock Mode

Figure 51 shows the signal connections for the echo clock mode. The echo clock mode is enabled by writing 0x1 to the CLK\_MD bit field of the modes register (see the [Modes Register](#) section). In this mode, the BUSY/SCKOUT pin cannot be used to detect a conversion completion. The BUSY\_SCKOUT pin becomes a bit clock output and is sourced by looping through the SCK of the host controller to the BUSY/SCKOUT pin (with some fixed delay, 5.4 ns to 7.9 ns, depending on VIO). To begin retrieving the conversion data in nonaveraging mode, the host controller must assert  $\overline{CS}$  low no sooner than 300 ns after the rising edge of the CNV pulse. When the ADC is configured for block averaging mode, the host controller must assert  $\overline{CS}$  low no sooner than 300 ns after the rising edge of the CNV pulse for the last sample in the block. Example timing diagrams are shown in the [Data Clocking Requirements and Timing](#) section. When echo clock mode is enabled, SCKOUT is aligned with the SDOx transitions, making the data and clock timing insensitive to asymmetric propagation delays in the SDOx and SCK paths.

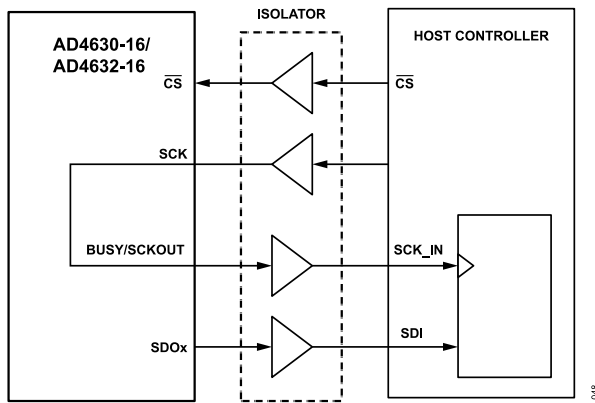

Figure 51. Echo Clock Mode Signal Path Diagram

## Host Clock Mode

When enabled, host clock mode uses the internal oscillator as the bit clock source. The host clock mode is enabled by writing 0x2 to the CLK\_MD bit field of the modes register. The bit clock frequency can be programmed in the OSC\_DIV bit field in the internal oscillator register, with available divisor values of 1, 2, or 4 (see the [Internal Oscillator Register](#) section). Figure 52 shows the signal connections for the host clock mode. In this mode, the BUSY/SCKOUT pin provides the bit clock output and cannot be used to detect a conversion completion. The AD4630-16/AD4632-16 automatically calculate the number of clock pulses required to clock out the conversion data based on word size, number of active lanes, and choice of single data rate or dual data rate mode. The number of clock pulses can be read from the OSC\_LIMIT bit field of the internal oscillator register. Note that for a 16-bit differential data-word (the OUT\_DATA\_MD field = 000 in the [Modes Register](#)), the AD4630-16/AD4632-16 add an additional eight clock pulses for a total of 24 clock pulses. The 16-bit data-word is padded with

eight zero bits. When host clock mode is enabled, SCK from the host must not be active. When retrieving the conversion data in nonaveraging mode, the host must not assert  $\overline{CS}$  low sooner than 300 ns after the rising edge of the CNV pulse. When the ADC is configured in averaging mode for  $2^N$  averages, the host must not assert  $\overline{CS}$  low sooner than 300 ns after the rising edge of CNV pulse for the last sample in the block.

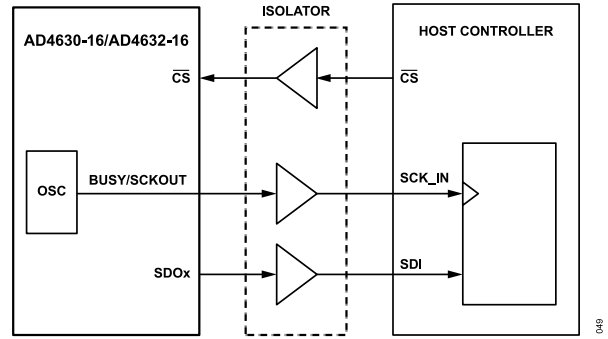

Figure 52. Host Clock Mode Signal Path Example

## Single Data Rate

SDR clocking, in which one bit (per active lane) is clocked out during a single clock cycle, is supported for all output configurations and sample formats (see [Table 14](#)). The SDR clocking mode is enabled by default at power-up or can be enabled by writing 0 to the DDR\_MD bit of the modes register (see the [Modes Register](#) section).

## Dual Data Rate

DDR mode (two data bit transitions per clock cycle per active lane) is available only for host clock mode and echo clock mode.

Note that the selected data rate mode is applied to both ADC channels. The DDR clocking mode is enabled by writing 1 to the DDR\_MD bit of the modes register (see the [Modes Register](#) section). The DDR mode uses half the number of SCK pulses to clock out conversion data in comparison to SDR mode.

## 1-Lane Output Data Clocking Mode

1-lane output data clocking mode is the default output data clocking mode at power-up. 1-lane output data clocking mode is enabled by writing 0x0 to the LANE\_MD bit of the modes register (see the [Modes Register](#) section). The active lane for ADC Channel 0 is SDO0. The active lane for ADC Channel 1 is SDO4. Example timing diagrams for 1-lane mode using SPI clocking mode, echo clock mode, and host clock mode are shown in the [Data Clocking Requirements and Timing](#) section.

## 2-Lane Output Data Clocking Mode

When 2-lane output data clocking mode is enabled, the sample word bits are split between two SDO lanes. Figure 55 shows how

## SERIAL INTERFACE

the bits are allocated between the lanes for 2-lane mode. The bit arrangement is the same for SPI clocking mode, echo clock mode, and host clock mode. 2-lane output data clocking mode is enabled by writing 0x1 to the LANE\_MD bit of the modes register (see the [Modes Register](#) section). The host controller must recombine the data coming from the SDO lanes to reconstruct the original sample word. The number of SCK pulses required to clock out the conversion data is reduced by one-half with respect to 1-lane mode. [Table 14](#) lists the active SDO lanes for 2-lane mode. Example timing diagrams for 2-lane mode using SPI clocking mode, echo clock mode, and host clock mode are shown in the [Data Clocking Requirements and Timing](#) section.

### 4-Lane Output Data Clocking Mode

When 4-lane output data clocking mode is enabled, the sample word bits are split between four SDO lanes. [Figure 56](#) shows how the bits are allocated between the lanes for 4-lane mode. The bit arrangement is the same for SPI clocking mode, echo clock mode, and host clock mode. 4-lane output data clocking mode is enabled by writing 0x2 to the LANE\_MD bit of the modes register (see the [Modes Register](#) section). The host controller must recombine the data coming from the SDO lanes to reconstruct the original sample word. The number of SCK pulses required to clock out the conversion data is reduced by one-fourth with respect to the 1-lane output data clocking. The active SDO lanes for 4-lane mode are shown in [Table 14](#). Example timing diagrams for 4-lane mode using

SPI clocking mode, echo clock mode, and host clock mode are shown in the [Data Clocking Requirements and Timing](#) section.

### Interleaved Lane Output Data Clocking Mode

In the interleaved lane output data clocking mode, Channel 0 and Channel 1 conversion data is interleaved on SDO0. The bit arrangement is shown in [Figure 57](#). The bit arrangement is the same for SPI clocking mode, echo clock mode, and host clock mode. Interleaved lane output data clocking mode is enabled by writing 0x3 to the LANE\_MD bit of the modes register (see the [Modes Register](#) section). The host controller must demultiplex the data on SDO0 to reconstruct the original sample words. The number of SCK pulses required to clock out the conversion data is increased by 2 $\times$  with respect to the 1-lane output data clocking. The data transfer can occur in either Zone 1 or Zone 2 (see [Figure 49](#)). Using the interleaved lane output data clocking mode allows the host controller to use a single SDO lane to retrieve data from both ADC channels, reducing I/O requirements for the digital interface. Examples of interleaved lane mode timing are shown in the [Data Clocking Requirements and Timing](#) section.

### Data Output Modes Summary

[Table 14](#) is a summary of the supported data output modes of the AD4630-16/AD4632-16.

**Table 14. Supported Data Output Modes**

Number of Lanes (per Channel)	Active SDO Lanes		Clock Mode	Supported Data Clocking Mode	Output Sample Data-Word Length
	Channel 0	Channel 1			
1	SDO0	SDO4	SPI Echo Host	SDR only SDR and DDR SDR and DDR	16, 24, or 32 16, 24, or 32 24 or 32
2	SDO0, SDO1	SDO4, SDO5	SPI Echo Host	SDR only SDR and DDR SDR and DDR	16, 24, or 32 16, 24, or 32 24 or 32
4	SDO0, SDO1, SDO2, SDO3	SDO4, SDO5, SDO6, SDO7	SPI Echo Host	SDR only SDR and DDR SDR and DDR	16, 24, or 32 16, 24, or 32 24 or 32
Interleaved	SDO0		SPI Echo Host	SDR only SDR and DDR SDR and DDR	32, 48, or 64 32, 48, or 64 48 or 64

SERIAL INTERFACE

DATA CLOCKING REQUIREMENTS AND TIMING

Basic and Averaging Conversion Cycles

Figure 53 shows the basic conversion cycle for a single sample. This cycle applies to SPI clocking mode. When using echo clock mode and host clock modes, the BUSY function is disabled and the bit clock is sourced on the BUSY pin. The data transfer must meet the requirements described in the Sample Conversion Timing and Data Transfer section.

Table 15 contains the minimum and maximum values for the conversion timing parameters, which apply to all clocking modes.

Table 15. Conversion Cycle Timing Parameters

Parameter	Minimum	Maximum
t <sub>CNVH</sub>	10 ns	No specific maximum
t <sub>CNVL</sub>	20 ns	No specific maximum
t <sub>CNV</sub>	264 ns	300 ns

The duration of the data transfer period is dependent on the sample resolution, number of active lanes, SCK frequency, and data clocking mode (SDR or DDR). The nominal value of the transfer duration is given by:

$$\text{Data Transfer Duration} = t_{TRANS} = \frac{N_{BITS}}{M_{LANES}} \times \frac{1}{f_{SCK}} \times \frac{1}{K} \text{ seconds}$$

where:

t<sub>TRANS</sub> is the transition time.

N<sub>BITS</sub> = number of bits to clock out.

M<sub>LANES</sub> = number of lanes used to clock out the data (1, 2, or 4).

f<sub>SCK</sub> = SCK clock frequency, in Hz.

K = 1 (SDR only, DDR not available for SPI mode clocking).

For a given f<sub>SCK</sub>, number of data lanes, sample word size, and SDR and DDR mode, the minimum sample period when using Zone 1 for the data transfer is as follows:

Minimum Zone 1 Sample Period:

$$t_{CYC} \geq \left( \frac{N_{BITS}}{M_{LANES} \times f_{SCK} \times K} \right) + t_{CONV} + t_{QUIET\_CNV\_ADV}$$

The minimum sample period when using Zone 2 for data transfer is as follows:

$$t_{CYC} \geq \left( \frac{N_{BITS}}{M_{LANES} \times f_{SCK} \times K} \right) + t_{QUIET\_CNV\_DELAY} + t_{QUIET\_CNV\_ADV}$$

Figure 54 shows a typical conversion cycle when the averaging mode is active and SPI clocking mode is used. The BUSY signal is asserted for a number of CNV clock periods that are equal to the configured number of samples to be averaged. The averaged sample is then available when the BUSY signal deasserts. Like nonaveraged mode, if the configured clocking mode is either echo clock or host clock, the BUSY signal is replaced by the output bit clock (SCKOUT). The host controller must manage the timing for asserting CS.

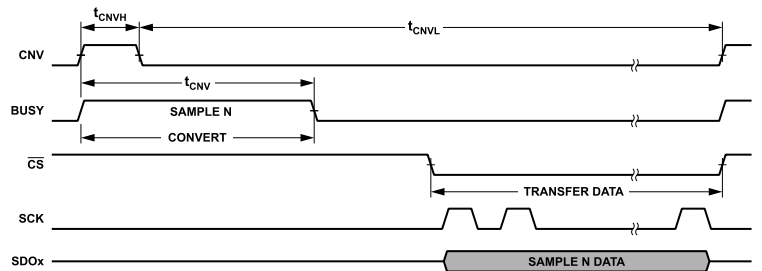

Figure 53. Basic Single Sample Conversion Cycle



Figure 54. Example Conversion Cycle for Averaging Mode



**SERIAL INTERFACE**

**SPI Clocking Mode Timing Diagrams**

**1-Lane, SDR Mode**

Figure 6 shows a conversion cycle for 1-lane data output using SDR clocking mode (1-bit transitions per clock cycle). This cycle timing is the same for both ADC channels.

**2-Lane, SDR Mode**

Figure 55 shows a conversion cycle for 2-lane data output using SDR clocking mode. Figure 55 shows the timing for Channel 0, but this diagram also applies to Channel 1. See the [2-Lane Output Data Clocking Mode](#) section for a detailed explanation.

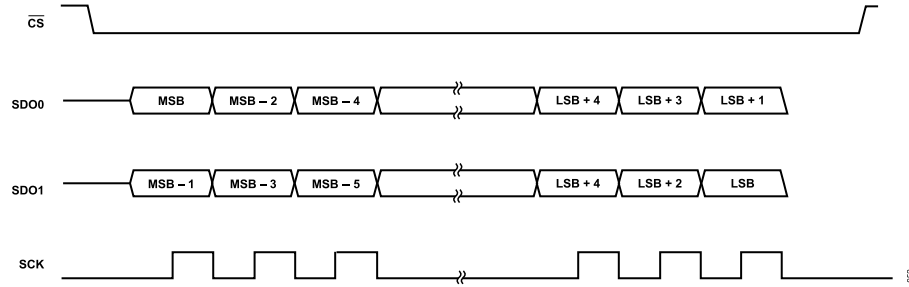

Figure 55. 2-Lane Mode, SDR Timing Diagram

**SERIAL INTERFACE**

**4-Lane, SDR Mode**

this diagram also applies to Channel 1. See the [4-Lane Output Data Clocking Mode](#) section for a detailed explanation.

Figure 56 shows a conversion cycle for 4-lane data output using SDR clocking mode. Figure 56 shows the timing for Channel 0, but

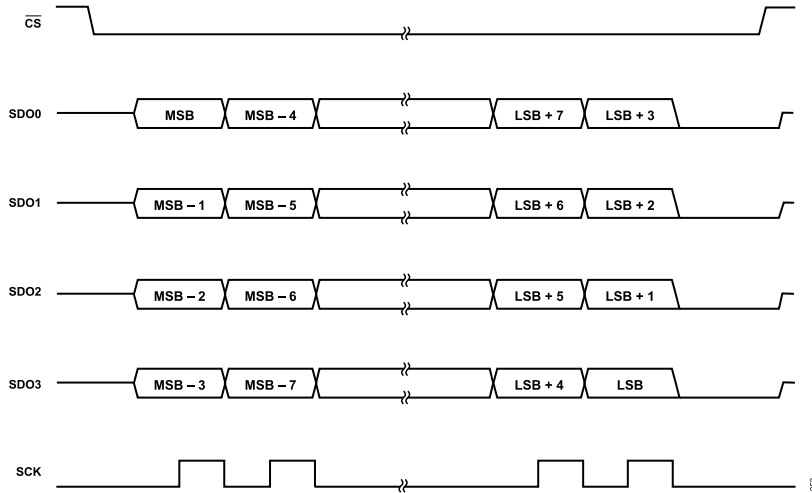

Figure 56. 4-Lane, SDR Timing Diagram

SERIAL INTERFACE

Interleaved Mode Timing, SDR Mode

Figure 57 shows a conversion cycle for interleaved data output using SDR clocking mode. See the [Interleaved-Lane Output Data Clocking Mode](#) section for a detailed explanation.

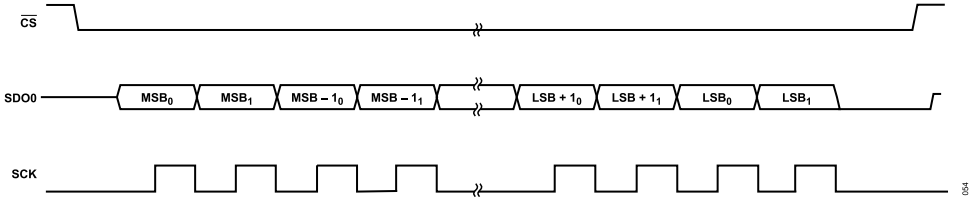

Figure 57. Interleaved Mode, SDR Timing Diagram

## SERIAL INTERFACE

### Echo Clock Timing Diagrams

#### 1-Lane, SDR Mode, Echo Clock Mode

Figure 7 shows the timing relationships for SDR mode (1-bit transitions per SCK period) in 1-lane echo clock mode. The timing relationships between the signals apply to 16-bit, 24-bit, and 32-bit sample word formats.

SCKOUT is a delayed version of the incoming SCK. The delay ( $t_{DSDO}$ ) has a maximum value of 5.6 ns (at  $V_{IO} > 1.71$  V). Changes in SDOx logic states are aligned to the rising edges of SCKOUT. The clock and data edge alignments are the same for 1-lane, 2-lane, and 4-lane output data modes.

#### 1-Lane, DDR Mode, Echo Clock Mode

Figure 8 shows the timing relationships for DDR mode (2-bit transitions per SCKOUT period) in 1-lane mode echo clock mode. The timing relationships between the signals apply to 16-bit, 24-bit, and 32-bit sample word formats.

Similar to SDR mode, SCKOUT is a delayed version of the incoming SCK. Changes in SDOx logic states are aligned to both rising and falling edges of SCKOUT.

### Host Clock Mode Timing

#### 1-Lane, Host Clock Mode, SDR

Figure 9 shows the timing relationships for host clock mode when using SDR mode and 1-lane mode. Similar to echo clock mode, the clock rising edges are aligned to the data bit transitions. The frequency of the SCKOUT signal is controlled by the OSC\_DIV value programmed in the internal oscillator register (see the [Internal Oscillator Register](#) section). Note that when the output data format is 16-bit differential (OUT\_DATA\_MD = 000 in the [Modes Register](#)), each 16-bit sample is padded with eight zeros, making the total word length 24 bits. The host processor discards these bits when processing the data.

#### 1-Lane, Host Clock Mode, DDR

Figure 10 shows the timing relationships for host clock mode when using DDR. Similar to echo clock mode, the rising and falling clock edges are aligned to the data bit transitions. The frequency of the SCKOUT signal is controlled by the OSC\_DIV value programmed in the internal oscillator register (see the [Internal Oscillator Register](#) section). Note that when the output data mode is 16-bit differential (OUT\_DATA\_MD = 000 in the [Modes Register](#)), eight zero bits are added to the 16-bit data-word (see the [Host Clock Mode](#) section).

## LAYOUT GUIDELINES

The following layout guidelines are recommended to achieve maximum performance of the AD4630-16/AD4632-16:

- ▶ The AD4630-16/AD4632-16 contain internal 1  $\mu\text{F}$  bypass capacitors for VDD\_5V and VDD\_1.8V, while VIO contains an internal 0.2  $\mu\text{F}$  capacitor. Therefore, no external bypass capacitors are required, saving board space, reducing BOM count, and reducing layout sensitivity.
- ▶ Have all the analog signals flow in from the left side of the AD4630-16/AD4632-16 and all the digital signals flow in and out from the right side of AD4630-16/AD4632-16 because this helps isolate analog signals from digital signals.
- ▶ Use a solid ground plane under the AD4630-16/AD4632-16 and connect all the analog ground (GND) pins and digital ground (IOGND) pins to the shared ground plane to avoid formation of ground loops.
- ▶ Traces routed to either the REFIN pin or REF pins must be isolated/shielded from other signals. Avoid routing signals beneath the reference trace (REFIN or REF). The REF pins are connected to an internal 2  $\mu\text{F}$  capacitor, eliminating the need to place a decoupling capacitor on the output of the external reference buffer. If a noise reduction filter is placed between the output of the reference (or buffer) and the chosen reference input, the filter must be placed as close as possible to the AD4630-16/AD4632-16.

## REGISTERS

The AD4630-16/AD4632-16 have programmable user registers that are used to configure these devices. These registers can be accessed while the AD4630-16/AD4632-16 is in register configuration mode. [Table 16](#) contains the complete list of the AD4630-16/AD4632-16 user registers and list of the bit fields in the registers.

The [Register Details](#) section contains details about the functions of each of the fields. The access mode specifies whether the register is comprised only of read-only bits (R) or a mix of read-only and read/write bits (R/W). Read-only bits cannot be overwritten by a SPI write transaction, whereas read/write bits can.

## REGISTERS

Table 16. Register Summary

Reg	Name	Bits	Bit 7	Bit 6	Bit 5	Bit 4	Bit 3	Bit 2	Bit 1	Bit 0	Reset	R/W	
0x00	INTERFACE_CONFIG_A	[7:0]	SW_RESET [7]	RESERVED [6]	ADDR_ASCENSION [5]	SDO_ENABLE [4]	RESERVED [3:1]			SW_RESETX [0]	0x10	R/W	
0x01	INTERFACE_CONFIG_B	[7:0]	SINGLE_INST [7]	STALLING [6]	RESERVED [5:4]		SHORT_INSTRUCTION [3]	RESERVED [2:0]			0x00	R/W	
0x02	DEVICE_CONFIG	[7:0]	RESERVED [7:2]						OPERATING_MODES [1:0]		0x00	R/W	
0x03	CHIP_TYPE	[7:0]	RESERVED [7:4]				CHIP_TYPE [3:0]			0x07	R		
0x04	PRODUCT_ID_L	[7:0]	PRODUCT_ID[7:0]									0x00	R
0x05	PRODUCT_ID_H	[7:0]	PRODUCT_ID[15:8]									0x20	R
0x06	CHIP_GRADE	[7:0]	GRADE [7:3]					DEVICE_REVISION [2:0]			0x00 <sup>1</sup>	R	
0x0A	SCRATCH_PAD	[7:0]	SCRATCH_VALUE [7:0]									0x00	R/W
0x0B	SPI_REVISION	[7:0]	SPI_TYPE [7:6]			VERSION [5:0]						0x81	R
0x0C	VENDOR_L	[7:0]	VID[7:0]									0x56	R
0x0D	VENDOR_H	[7:0]	VID[15:8]									0x04	R
0x0E	STREAM_MODE	[7:0]	LOOP_COUNT [7:0]									0x00	R/W
0x11	INTERFACE_STATUS_A	[7:0]	RESERVED [7:5]			CLOCK_COUNTER [4]	RESERVED [3:0]				0x00	R/W	
0x14	EXIT_CFG_MD	[7:0]	RESERVED [7:1]								EXIT_CONFIG_MD [0]	0x00	R/W
0x15	AVG	[7:0]	AVG_SYNC [7]	RESERVED [6:5]			AVG_VAL [4:0]				0x00	R/W	
0x16	RESERVED	[7:0]	RESERVED									0x00	R
0x17	OFFSET_CH0_LB	[7:0]	CH0_USER_OFFSET[7:0]									0x00	R/W
0x18	OFFSET_CH0_HB	[7:0]	CH0_USER_OFFSET[15:8]									0x00	R/W
0x19	RESERVED	[7:0]	RESERVED									0x00	R
0x1A	OFFSET_CH1_LB	[7:0]	CH1_USER_OFFSET[7:0]									0x00	R/W
0x1B	OFFSET_CH1_HB	[7:0]	CH1_USER_OFFSET[15:8]									0x00	R/W
0x1C	GAIN_CH0_LB	[7:0]	CH0_USER_GAIN[7:0]									0x00	R/W
0x1D	GAIN_CH0_HB	[7:0]	CH0_USER_GAIN[15:8]									0x80	R/W
0x1E	GAIN_CH1_LB	[7:0]	CH1_USER_GAIN[7:0]									0x00	R/W
0x1F	GAIN_CH1_HB	[7:0]	CH1_USER_GAIN[15:8]									0x80	R/W
0x20	MODES	[7:0]	LANE_MD [7:6]			CLK_MD [5:4]		DDR_MD [3]	OUT_DATA_MD [2:0]			0x00	R/W
0x21	OSCILLATOR	[7:0]	OSC_LIMIT [7:2]					OSC_DIV [1:0]				0x00	R/W
0x22	IO	[7:0]	RESERVED [7:1]								IO2X [0]	0x00	R/W
0x23	TEST_PAT_BYTE0	[7:0]	TEST_DATA_PAT[7:0]									0x0F	R/W
0x24	TEST_PAT_BYTE1	[7:0]	TEST_DATA_PAT[15:8]									0x0F	R/W
0x25	TEST_PAT_BYTE2	[7:0]	TEST_DATA_PAT[23:16]									0x5A	R/W
0x26	TEST_PAT_BYTE3	[7:0]	TEST_DATA_PAT[31:24]									0x5A	R/W
0x34	DIG_DIAG	[7:0]	POWERUP_COMPLETED [7]	RESET_OCCURRED [6]	RESERVED [5:1]					FUSE_CRC_EN [0]	0x40	R/W	
0x35	DIG_ERR	[7:0]	RESERVED [7:1]								FUSE_CRC_ERR [0]	0x00	R/W

<sup>1</sup> See the [Chip Grade Register](#) section for model specific reset values.

## REGISTER DETAILS

## INTERFACE CONFIGURATION A REGISTER

Address: 0x00, Reset: 0x10, Name: INTERFACE\_CONFIG\_A

Interface configuration settings.

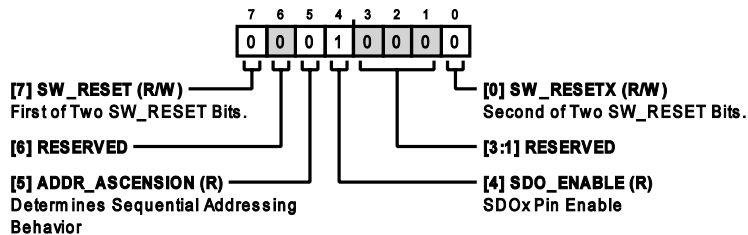

Table 17. Bit Descriptions for INTERFACE\_CONFIG\_A

Bits	Bit Name	Description	Reset	Access
7	SW_RESET	First of two SW_RESET bits. This bit appears in two locations in this register. Both locations must be written at the same time to trigger a software reset of the device. All registers except for this register reset to their default values.	0x0	R/W
6	RESERVED	Reserved.	0x0	R
5	ADDR_ASCENSION	Determines sequential addressing behavior. 0: address accessed is decremented by one for each data byte when streaming. 1: not a valid option.	0x0	R
4	SDO_ENABLE	SDOx Pin Enable.	0x1	R
[3:1]	RESERVED	Reserved.	0x0	R
0	SW_RESETX	Second of two SW_RESET bits. This bit appears in two locations in this register. Both locations must be written at the same time to trigger a software reset of the device. All registers except for this register reset to their default values.	0x0	R/W

## INTERFACE CONFIGURATION B REGISTER

Address: 0x01, Reset: 0x00, Name: INTERFACE\_CONFIG\_B

Additional interface configuration settings.

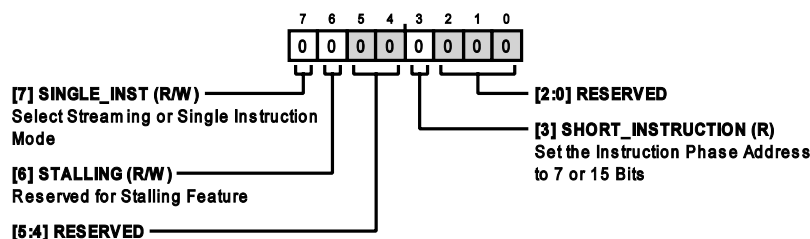

Table 18. Bit Descriptions for INTERFACE\_CONFIG\_B

Bits	Bit Name	Description	Reset	Access
7	SINGLE_INST	Select streaming or single instruction mode. 0: streaming mode is enabled. The address decrements as successive data bytes are received. 1: single instruction mode is enabled.	0x0	R/W
6	STALLING	Reserved for Stalling Feature.	0x0	R/W
[5:4]	RESERVED	Reserved.	0x0	R
3	SHORT_INSTRUCTION	Set the instruction phase address to 7 or 15 bits. 0: 15-bit addressing. 1: 7-bit addressing.	0x0	R



## REGISTER DETAILS

Table 18. Bit Descriptions for INTERFACE\_CONFIG\_B

Bits	Bit Name	Description	Reset	Access
[2:0]	RESERVED	Reserved.	0x0	R

## DEVICE CONFIGURATION REGISTER

Address: 0x02, Reset: 0x00, Name: DEVICE\_CONFIG

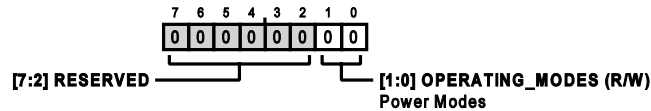

Table 19. Bit Descriptions for DEVICE\_CONFIG

Bits	Bit Name	Description	Reset	Access
[7:2]	RESERVED	Reserved.	0x0	R
[1:0]	OPERATING_MODES	Power Modes. 00: normal operating mode. 11: shutdown mode.	0x0	R/W

## CHIP TYPE REGISTER

Address: 0x03, Reset: 0x07, Name: CHIP\_TYPE

The chip type is used to identify the family of Analog Devices products a given device belongs to. Use the chip type with the product ID to uniquely identify a given product.

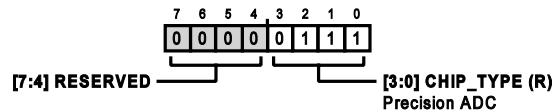

Table 20. Bit Descriptions for CHIP\_TYPE

Bits	Bit Name	Description	Reset	Access
[7:4]	RESERVED	Reserved.	0x0	R
[3:0]	CHIP_TYPE	Precision ADC.	0x7	R

## PRODUCT ID LOW REGISTER

Address: 0x04, Reset: 0x00, Name: PRODUCT\_ID\_L

Low byte of the product ID.

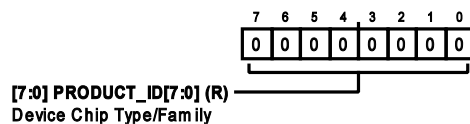

Table 21. Bit Descriptions for PRODUCT\_ID\_L

Bits	Bit Name	Description	Reset	Access
[7:0]	PRODUCT_ID[7:0]	Device Chip Type/Family. Use the product ID with the chip type to identify a product.	0x0	R

## PRODUCT ID HIGH REGISTER

Address: 0x05, Reset: 0x20, Name: PRODUCT\_ID\_H

High byte of the product ID.

## REGISTER DETAILS

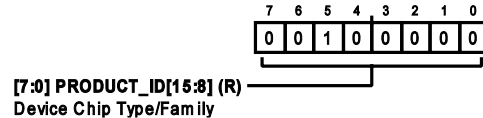

Table 22. Bit Descriptions for PRODUCT\_ID\_H

Bits	Bit Name	Description	Reset	Access
[7:0]	PRODUCT_ID[15:8]	Device Chip Type/Family. Use the product ID with the chip type to identify a product.	0x20	R

## CHIP GRADE REGISTER

Address: 0x06, Reset: 0x00, Name: CHIP\_GRADE

Identifies product variations and device revisions.

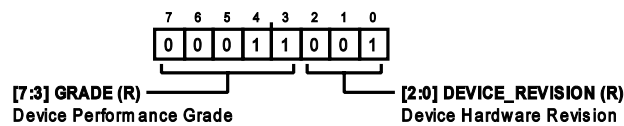

Table 23. Bit Descriptions for CHIP\_GRADE

Bits	Bit Name	Description	Reset	Access
[7:3]	GRADE	Device Performance Grade.		R
		AD4630-16: 0b00011	0x03	R
		AD4632-16: 0b00101	0x05	R
[2:0]	DEVICE_REVISION	Device Hardware Revision.	0x1	R

## SCRATCH PAD REGISTER

Address: 0x0A, Reset: 0x00, Name: SCRATCH\_PAD

This register can be used to test writes and reads.

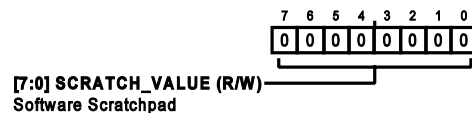

Table 24. Bit Descriptions for SCRATCH\_PAD

Bits	Bit Name	Description	Reset	Access
[7:0]	SCRATCH_VALUE	Software Scratchpad. Software can write to and read from this location without any device side effects.	0x0	R/W

## SPI REVISION REGISTER

Address: 0x0B, Reset: 0x81, Name: SPI\_REVISION

Indicates the SPI revision.

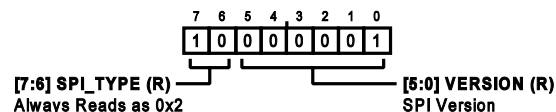

Table 25. Bit Descriptions for SPI\_REVISION

Bits	Bit Name	Description	Reset	Access
[7:6]	SPI_TYPE	Always reads as 0x2.	0x2	R
[5:0]	VERSION	SPI Version.	0x1	R

## REGISTER DETAILS

## VENDOR ID LOW REGISTER

Address: 0x0C, Reset: 0x56, Name: VENDOR\_L

Low byte of the vendor ID.

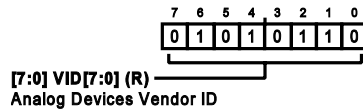

Table 26. Bit Descriptions for VENDOR\_L

Bits	Bit Name	Description	Reset	Access
[7:0]	VID[7:0]	Analog Devices Vendor ID.	0x56	R

## VENDOR ID HIGH REGISTER

Address: 0x0D, Reset: 0x04, Name: VENDOR\_H

High byte of the vendor ID.

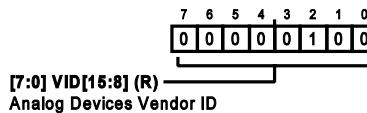

Table 27. Bit Descriptions for VENDOR\_H

Bits	Bit Name	Description	Reset	Access
[7:0]	VID[15:8]	Analog Devices Vendor ID.	0x4	R

## STREAM MODE REGISTER

Address: 0x0E, Reset: 0x00, Name: STREAM\_MODE

Defines the length of the loop when streaming data.

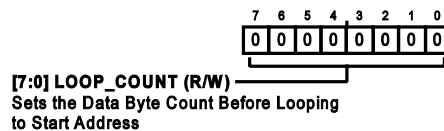

Table 28. Bit Descriptions for STREAM\_MODE

Bits	Bit Name	Description	Reset	Access
[7:0]	LOOP_COUNT	Sets the data byte count before looping to start address. Not enabled in the AD4630-16.	0x0	R/W

## INTERFACE STATUS A REGISTER

Address: 0x11, Reset: 0x00, Name: INTERFACE\_STATUS\_A

Status bits are set to 1 to indicate an active condition. The status bits can be cleared by writing a 1 to the corresponding bit location.

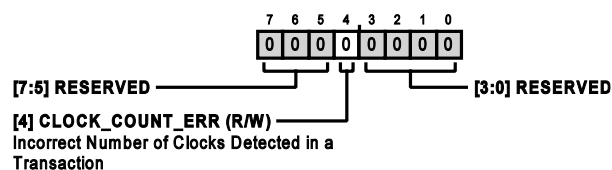

## REGISTER DETAILS

Table 29. Bit Descriptions for INTERFACE\_STATUS\_A

Bits	Bit Name	Description	Reset	Access
[7:5]	RESERVED	Reserved.	0x0	R
4	CLOCK_COUNT_ERR	0 = No error. 1 = Incorrect Number of Clocks Detected in a Transaction. Write 1 to clear.	0x0	R/W1C
[3:0]	RESERVED	Reserved.	0x0	R

## EXIT CONFIGURATION MODE REGISTER

Address: 0x14, Reset: 0x00, Name: EXIT\_CFG\_MD

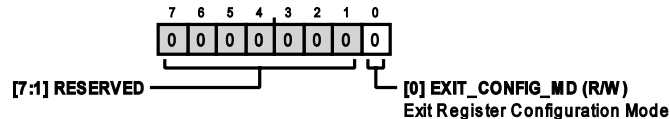

Table 30. Bit Descriptions for EXIT\_CFG\_MD

Bits	Bit Name	Description	Reset	Access
[7:1]	RESERVED	Reserved.	0x0	R
0	EXIT_CONFIG_MD	Exit Register Configuration Mode. Write 1 to exit register configuration mode. Self clearing on $\overline{CS} = 1$ .	0x0	R/W

## AVERAGING MODE REGISTER

Address: 0x15, Reset: 0x00, Name: AVG

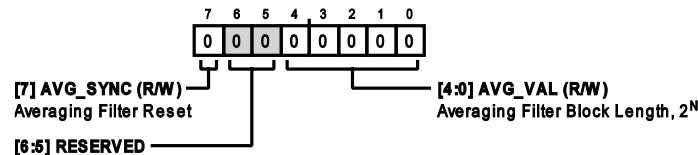

Table 31. Bit Descriptions for AVG

Bits	Bit Name	Description	Reset	Access
7	AVG_SYNC	Averaging Filter Reset. 1 = reset, self clearing.	0x0	R/W
[6:5]	RESERVED	Reserved.	0x0	R
[4:0]	AVG_VAL	Averaging Filter Block Length, $2^N$ . 0x00 = no averaging. This setting is invalid when averaging is enabled (OUT_DATA_MD = 011). 0x01 = $2^1$ samples. 0x02 = $2^2$ samples. 0x03 = $2^3$ samples. 0x04 = $2^4$ samples. 0x05 = $2^5$ samples. ... 0x0F = $2^{15}$ samples. 0x10 = $2^{16}$ samples. 0x11 through 0x1F = invalid.	0x0	R/W

## REGISTER DETAILS

## CHANNEL 0 OFFSET REGISTERS

Address: 0x17, Reset: 0x00, Name: OFFSET\_CH0\_LB

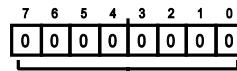

[7:0] CH0\_USER\_OFFSET[7:0] (R/W)  
16-Bit Channel 0 Offset

Table 32. Bit Descriptions for OFFSET\_CH0\_LB

Bits	Bit Name	Description	Reset	Access
[7:0]	CH0_USER_OFFSET[7:0]	16-Bit Channel 0 Offset. Twos complement (signed). 1 LSB = $(V_{REF}/2^{15})$ gain. See the <a href="#">Channel 0 Gain Registers</a> section for a description of the gain parameter.	0x0	R/W

Address: 0x18, Reset: 0x00, Name: OFFSET\_CH0\_HB

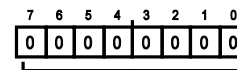

[7:0] CH0\_USER\_OFFSET[15:8] (R/W)  
16-Bit Channel 0 Offset

Table 33. Bit Descriptions for OFFSET\_CH0\_HB

Bits	Bit Name	Description	Reset	Access
[7:0]	CH0_USER_OFFSET[15:8]	16-Bit Channel 0 Offset. Twos complement (signed). 1 LSB = $(V_{REF}/2^{15})$ gain. See the <a href="#">Channel 0 Gain Registers</a> section for a description of the gain parameter.	0x0	R/W

## CHANNEL 1 OFFSET REGISTERS

Address: 0x1A, Reset: 0x00, Name: OFFSET\_CH1\_LB

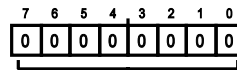

[7:0] CH1\_USER\_OFFSET[7:0] (R/W)  
16-Bit Channel 1 Offset

Table 34. Bit Descriptions for OFFSET\_CH1\_LB

Bits	Bit Name	Description	Reset	Access
[7:0]	CH1_USER_OFFSET[7:0]	16-Bit Channel 1 Offset. Twos complement (signed). 1 LSB = $(V_{REF}/2^{15})$ gain. See the <a href="#">Channel 1 Gain Registers</a> section for a description of the gain parameter value.	0x0	R/W

Address: 0x1B, Reset: 0x00, Name: OFFSET\_CH1\_HB

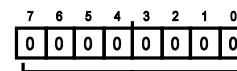

[7:0] CH1\_USER\_OFFSET[15:8] (R/W)  
16-Bit Channel 1 Offset

Table 35. Bit Descriptions for OFFSET\_CH1\_HB

Bits	Bit Name	Description	Reset	Access
[7:0]	CH1_USER_OFFSET[15:8]	16-Bit Channel 1 Offset. Twos complement (signed). 1 LSB = $(V_{REF}/2^{15})$ gain. See the <a href="#">Channel 1 Gain Registers</a> section for a description of the gain parameter value.	0x0	R/W

## CHANNEL 0 GAIN REGISTERS

Address: 0x1C, Reset: 0x00, Name: GAIN\_CH0\_LB

REGISTER DETAILS

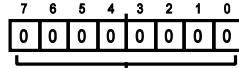

[7:0] CH0\_USER\_GAIN[7:0] (R/W)  
Channel 0 Gain Word (Unsigned)

Table 36. Bit Descriptions for GAIN\_CH0\_LB

Bits	Bit Name	Description	Reset	Access
[7:0]	CH0_USER_GAIN[7:0]	Channel 0 Gain Word (Unsigned). Multiplier output = input × gain word/0x8000. Maximum effective gain = 0xFFFF/0x8000 = 1.99997.	0x00	R/W

Address: 0x1D, Reset: 0x80, Name: GAIN\_CH0\_HB

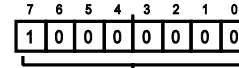

[7:0] CH0\_USER\_GAIN[15:8] (R/W)  
Channel 0 Gain Word (Unsigned)

Table 37. Bit Descriptions for GAIN\_CH0\_HB

Bits	Bit Name	Description	Reset	Access
[7:0]	CH0_USER_GAIN[15:8]	Channel 0 Gain Word (Unsigned). Multiplier output = input × gain word/0x8000. Maximum effective gain = 0xFFFF/0x8000 = 1.99997.	0x80	R/W

CHANNEL 1 GAIN REGISTERS

Address: 0x1E, Reset: 0x00, Name: GAIN\_CH1\_LB

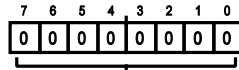

[7:0] CH1\_USER\_GAIN[7:0] (R/W)  
Channel 1 Gain Word (Unsigned)

Table 38. Bit Descriptions for GAIN\_CH1\_LB

Bits	Bit Name	Description	Reset	Access
[7:0]	CH1_USER_GAIN[7:0]	Channel 1 Gain Word (Unsigned). Multiplier output = input × gain word/0x8000. Maximum effective gain = 0xFFFF/0x8000 = 1.99997.	0x00	R/W

Address: 0x1F, Reset: 0x80, Name: GAIN\_CH1\_HB

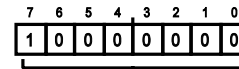

[7:0] CH1\_USER\_GAIN[15:8] (R/W)  
Channel 1 Gain Word (Unsigned)

Table 39. Bit Descriptions for GAIN\_CH1\_HB

Bits	Bit Name	Description	Reset	Access
[7:0]	CH1_USER_GAIN[15:8]	Channel 1 Gain Word (Unsigned). Multiplier output = input × gain word/0x8000. Maximum effective gain = 0xFFFF/0x8000 = 1.99997.	0x80	R/W

MODES REGISTER

Address: 0x20, Reset: 0x00, Name: MODES

REGISTER DETAILS

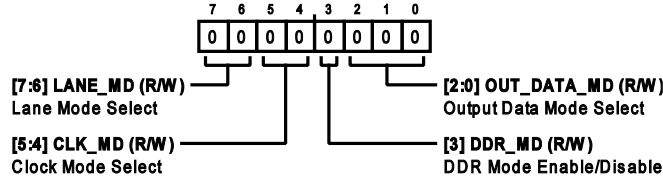

Table 40. Bit Descriptions for MODES

Bits	Bit Name	Description	Reset	Access
[7:6]	LANE_MD	Lane Mode Select. 00 = one lane per channel. 01 = two lanes per channel. 10 = four lanes per channel. 11 = Channel 0 and Channel 1 interleaved on SDO0.	0x0	R/W
[5:4]	CLK_MD	Clock Mode Select. 00 = SPI clocking mode. 01 = echo clock mode. 10 = host clock mode. 11 = invalid setting.	0x0	R/W
3	DDR_MD	DDR Mode Enable/Disable. 0 = SDR. 1 = DDR (only valid for echo clock and host clock modes).	0x0	R/W
[2:0]	OUT_DATA_MD	Output Data Mode Select. 000 = 16-bit differential data. 001 = 16-bit differential data + 8-bit common mode data. 010 = unused 011 = 30-bit averaged differential data + OR bit + SYNC bit. 100 = 32-bit test data pattern (see the <a href="#">Test Pattern Registers</a> section).	0x0	R/W

INTERNAL OSCILLATOR REGISTER

Address: 0x21, Reset: 0x00, Name: OSCILLATOR

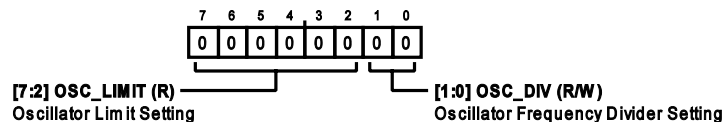

Table 41. Bit Descriptions for OSCILLATOR

Bits	Bit Name	Description	Reset	Access
[7:2]	OSC_LIMIT	Oscillator Limit Setting. Oscillator is limited to this number of clock pulses plus one. Automatically calculated by the AD4630-16/AD4632-16 based on the data-word size, number of active SDO lanes, and data rate mode (SDR or DDR).	0x0	R
[1:0]	OSC_DIV	Oscillator Frequency Divider Setting. 00 = no divide (divide by 1). 01 = divide by 2. 10 = divide by 4. 11 = invalid setting.	0x0	R/W

OUTPUT DRIVER REGISTER

Address: 0x22, Reset: 0x00, Name: IO

REGISTER DETAILS

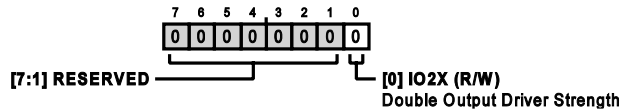

Table 42. Bit Descriptions for IO

Bits	Bit Name	Description	Reset	Access
[7:1]	RESERVED	Reserved.	0x0	R
0	IO2X	Double Output Driver Strength. 1 = double output driver strength. 0 = normal output driver strength.	0x0	R/W

TEST PATTERN REGISTERS

Address: 0x23, Reset: 0x0F, Name: TEST\_PAT\_BYTE0

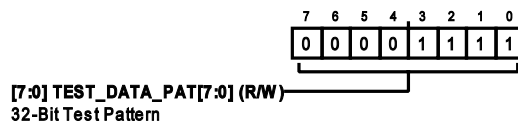

Table 43. Bit Descriptions for TEST\_PAT\_BYTE0

Bits	Bit Name	Description	Reset	Access
[7:0]	TEST_DATA_PAT[7:0]	32-Bit Test Pattern. Applied to both channels when OUT_DATA_MD = 4 (see the Modes Register section).	0xF	R/W

Address: 0x24, Reset: 0x0F, Name: TEST\_PAT\_BYTE1

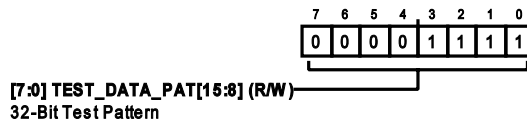

Table 44. Bit Descriptions for TEST\_PAT\_BYTE1

Bits	Bit Name	Description	Reset	Access
[7:0]	TEST_DATA_PAT[15:8]	32-Bit Test Pattern. Applied to both channels when OUT_DATA_MD = 4 (see the Modes Register section).	0xF	R/W

Address: 0x25, Reset: 0x5A, Name: TEST\_PAT\_BYTE2

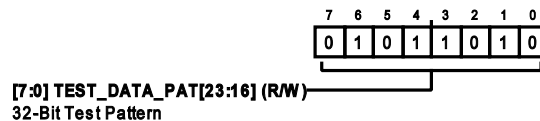

Table 45. Bit Descriptions for TEST\_PAT\_BYTE2

Bits	Bit Name	Description	Reset	Access
[7:0]	TEST_DATA_PAT[23:16]	32-Bit Test Pattern. Applied to both channels when OUT_DATA_MD = 4 (see the Modes Register section).	0x5A	R/W

Address: 0x26, Reset: 0x5A, Name: TEST\_PAT\_BYTE3



REGISTER DETAILS

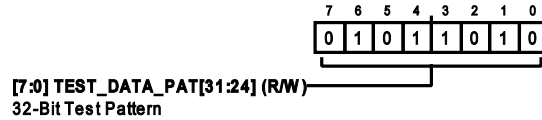

Table 46. Bit Descriptions for TEST\_PAT\_BYTE3

Bits	Bit Name	Description	Reset	Access
[7:0]	TEST_DATA_PAT[31:24]	32-Bit Test Pattern. Applied to both channels when OUT_DATA_MD = 4 (see the Modes Register section).	0x5A	R/W

DIGITAL DIAGNOSTICS REGISTER

Address: 0x34, Reset: 0x40, Name: DIG\_DIAG

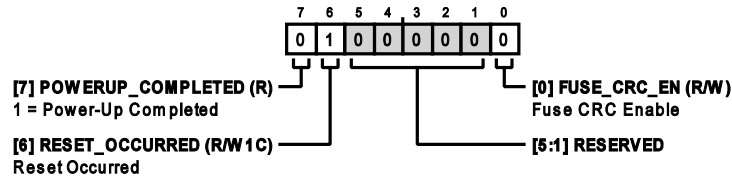

Table 47. Bit Descriptions for DIG\_DIAG

Bits	Bit Name	Description	Reset	Access
7	POWERUP_COMPLETED	1 = Power-Up Completed. Self clearing.	0x0	R
6	RESET_OCCURRED	Reset Occurred. This bit is set to 1 upon a reset event. Write 1 to clear (useful for detecting brownouts).	0x1	R/W1C
[5:1]	RESERVED	Reserved.	0x0	R
0	FUSE_CRC_EN	Fuse CRC Enable. Write a 1 to force recheck of CRC.	0x0	R/W

DIGITAL ERRORS REGISTER

Address: 0x35, Reset: 0x00, Name: DIG\_ERR

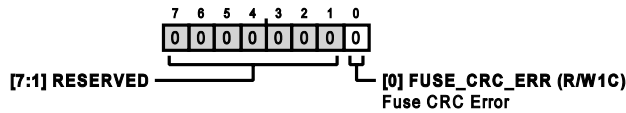

Table 48. Bit Descriptions for DIG\_ERR

Bits	Bit Name	Description	Reset	Access
[7:1]	RESERVED	Reserved.	0x0	R
0	FUSE_CRC_ERR	Fuse CRC Error. This bit is set to 1 upon a fuse CRC error. Write 1 to clear.	0x0	R/W1C

OUTLINE DIMENSIONS

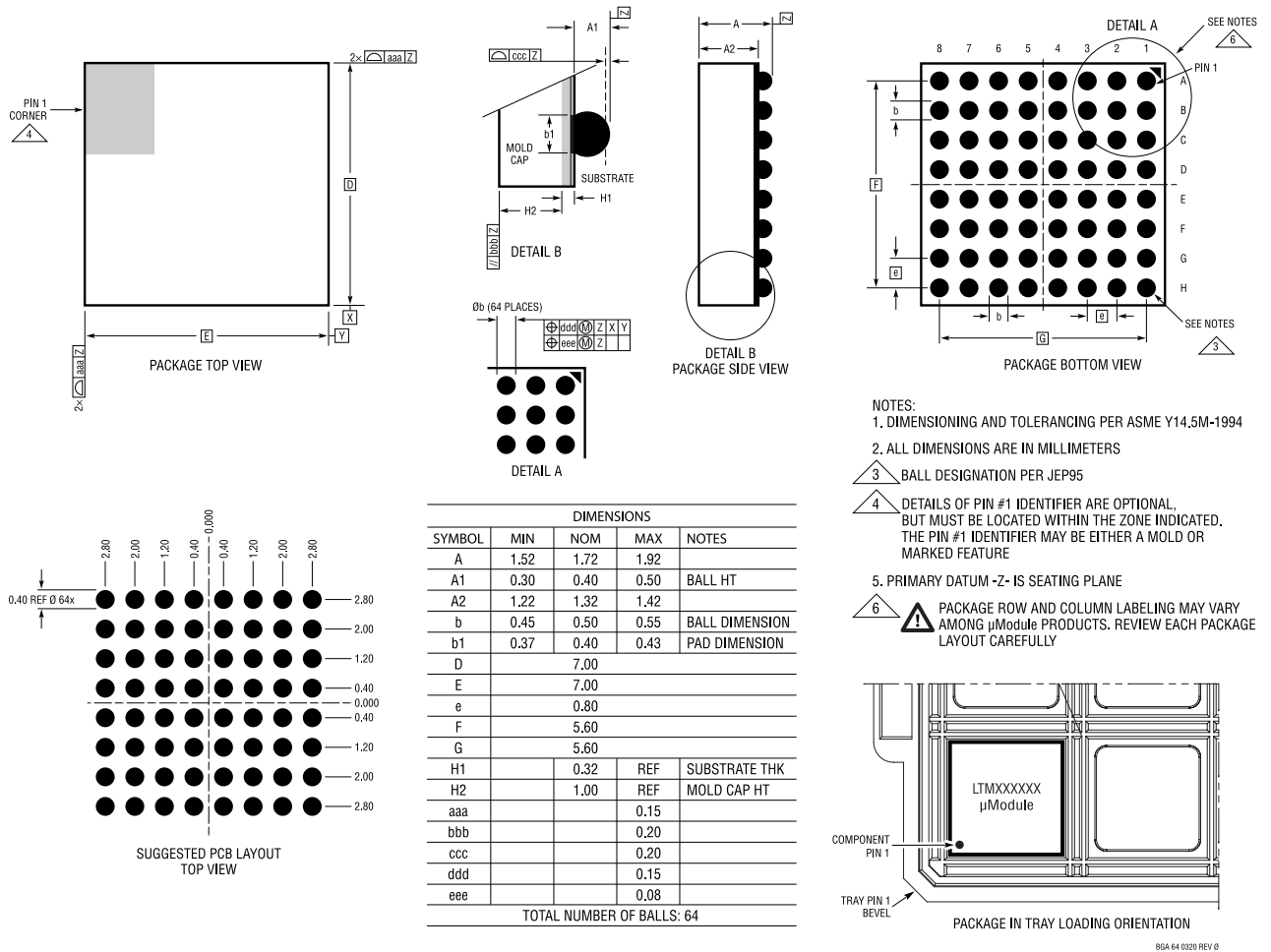

Figure 58. 64-Ball Chip Scale Package Ball Grid Array [CSP\_BGA] (05-08-1797)  
Dimensions shown in millimeters

Updated: September 27, 2022

ORDERING GUIDE

Model <sup>1</sup>	Temperature Range	Package Description	Packing Quantity	Package Option
AD4630-16BBCZ	-40°C to +125°C	64-Lead CSP_BGA (7 mm x 7 mm x 1.72 mm)	Tray, 260	05-08-1797
AD4630-16BBCZ-RL	-40°C to +125°C	64-Lead CSP_BGA (7 mm x 7 mm x 1.72 mm)	Reel, 2000	05-08-1797
AD4632-16BBCZ	-40°C to +125°C	64-Lead CSP_BGA (7 mm x 7 mm x 1.72 mm)	Tray, 260	05-08-1797
AD4632-16BBCZ-RL	-40°C to +125°C	64-Lead CSP_BGA (7 mm x 7 mm x 1.72 mm)	Reel, 2000	05-08-1797

<sup>1</sup> Z = RoHS Compliant Part.

**OUTLINE DIMENSIONS****EVALUATION BOARDS***Table 49. Evaluation Boards*

Model <sup>1,2</sup>	Description
EVAL-AD4630-16-KTZ	Evaluation Kit
EVAL-AD4630-16FMCZ	Evaluation Board

<sup>1</sup> Z = RoHS Compliant Part.

<sup>2</sup> The EVAL-AD4630-16-KTZ and EVAL-AD4630-16FMCZ can be used to evaluate the AD4632-16.

## X-ON Electronics

Largest Supplier of Electrical and Electronic Components

*Click to view similar products for [Analog to Digital Converters - ADC category](#):*

*Click to view products by [Analog Devices manufacturer](#):*

Other Similar products are found below :

[MCP37211-200I/TE](#) [AD9235BCPZRL7-40](#) [HT7316ARQZ](#) [ADS1100A3IDBVR](#) [HI1175JCB](#) [HI3-574AJN-5](#) [HI5714/4CB](#) [HI5746KCA](#)  
[HI5766KCAZ](#) [HI5766KCBZ](#) [ISOSD61TR](#) [ES7201](#) [AD7266BSUZ-REEL](#) [AD7708BRZ-REEL7](#) [CLM2543IDW](#) [CLM2543CDW](#)  
[MCP3004T-I/SL](#) [ADS7853IPWR](#) [GP9301BXI-F10K-D1V10-SH](#) [GP9301BXI-F10K-N-SH](#) [GP9101-F50-C1H1-SW](#) [GP9301BXI-F5K-N-SW](#)  
[GP9101-F10K-N-SW](#) [GP9301BXI-F4K-D1V10-SH](#) [GP9301BXI-F1K-L5H2-SH](#) [LTC2484IDD#TRPBF](#) [AD9245BCPZRL7-20](#) [SSP1120](#)  
[ADS8332IBRGER](#) [HT7705ARWZ](#) [ADS9224RIRHBR](#) [ADC101S051CIMF](#) [AD7779ACPZ-RL](#) [AD7714YRUZ-REEL](#) [LTC2447IUHF#PBF](#)  
[AD9235BRUZRL7-20](#) [AD7888ARUZ-REEL](#) [AD7606BBSTZ-RL](#) [AD7998BRUZ-1REEL](#) [AD7276ARMZ-REEL](#) [AD7712ARZ-REEL](#)  
[AD7997BRUZ-1REEL](#) [LTC2348ILX-16#PBF](#) [AD2S1210BSTZ-RL7](#) [AD7711ARZ-REEL7](#) [AD7865ASZ-1REEL](#) [AD7923BRUZ-REEL](#)  
[AD7495ARZ-REEL7](#) [AD9629BCPZRL7-40](#) [AD7794CRUZ-REEL](#)