

FEATURES

- Single-channel, 1024-position resolution
- 20 k Ω nominal resistance
- Maximum $\pm 1\%$ nominal resistor tolerance error (resistor performance mode)
- 20-times programmable wiper memory
- Rheostat mode temperature coefficient: 35 ppm/ $^{\circ}\text{C}$
- Voltage divider temperature coefficient: 5 ppm/ $^{\circ}\text{C}$
- +9 V to +33 V single-supply operation
- ± 9 V to ± 16.5 V dual-supply operation
- SPI-compatible serial interface
- Wiper setting readback
- Power-on refreshed from 20-TP memory

ENHANCED PRODUCT FEATURES

- Supports defense and aerospace applications (AQEC)
- Temperature range: -55°C to $+125^{\circ}\text{C}$
- Controlled manufacturing baseline
- 1 assembly/test site
- 1 fabrication site
- Product change notification
- Qualification data available on request

APPLICATIONS

- Mechanical potentiometer replacement
- Instrumentation: gain and offset adjustment
- Programmable voltage-to-current conversion
- Programmable filters, delays, and time constants
- Programmable power supply
- Low resolution DAC replacement
- Sensor calibration

GENERAL DESCRIPTION

The AD5292-EP is a single-channel, 1024-position digital potentiometer¹ that combines industry leading variable resistor performance with nonvolatile memory (NVM) in a compact package. This device is capable of operating across a wide voltage range, supporting both dual supply operation at ± 10.5 V to ± 16.5 V and single-supply operation at +21 V to +33 V, while ensuring less than 1% end-to-end resistor tolerance error and offering 20-time programmable (20-TP) memory.

The guaranteed industry leading low resistor tolerance error feature simplifies open-loop applications as well as precision calibration and tolerance matching applications.

¹ The terms digital potentiometer and RDAC are used interchangeably.

Rev. A

[Document Feedback](#)

Information furnished by Analog Devices is believed to be accurate and reliable. However, no responsibility is assumed by Analog Devices for its use, nor for any infringements of patents or other rights of third parties that may result from its use. Specifications subject to change without notice. No license is granted by implication or otherwise under any patent or patent rights of Analog Devices. Trademarks and registered trademarks are the property of their respective owners.

FUNCTIONAL BLOCK DIAGRAM

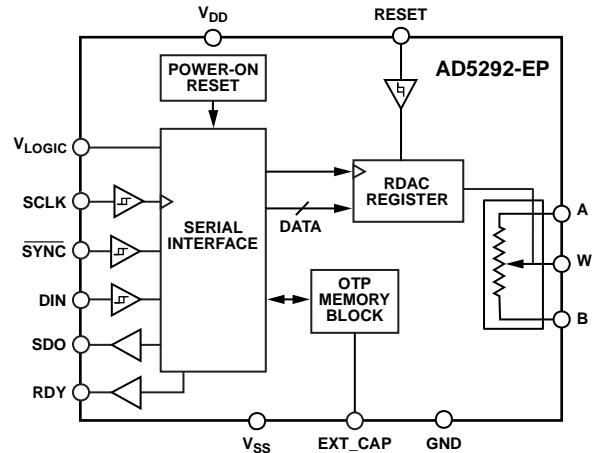

Figure 1.

10095-001

The AD5292-EP device wiper settings are controllable through the SPI digital interface. Unlimited adjustments are allowed before programming the resistance value into the 20-TP memory. The AD5292-EP does not require any external voltage supply to facilitate fuse blow, and there are 20 opportunities for permanent programming. During 20-TP activation, a permanent blow fuse command freezes the wiper position (analogous to placing epoxy on a mechanical trimmer).

The AD5292-EP is available in a compact 14-lead TSSOP package. The part is guaranteed to operate over the extended industrial temperature range of -55°C to $+125^{\circ}\text{C}$.

Additional application and technical information can be found in the [AD5292](#) data sheet.

TABLE OF CONTENTS

Features	1	Interface Timing Specifications.....	5
Enhanced Product Features	1	Absolute Maximum Ratings	7
Applications.....	1	Thermal Resistance	7
Functional Block Diagram	1	ESD Caution.....	7
General Description	1	Pin Configuration and Function Descriptions.....	8
Revision History	2	Typical Performance Characteristics	9
Specifications.....	3	Test Circuits.....	14
Electrical Characteristics—AD5292-EP.....	3	Outline Dimensions	15
Resistor Performance Mode Code Range	4	Ordering Guide	15

REVISION HISTORY

4/2018—Rev. 0 to Rev. A

Change to Enhanced Product Features Section	1
Changes to Ordering Guide	15

9/2011—Revision 0: Initial Version

SPECIFICATIONS

ELECTRICAL CHARACTERISTICS—AD5292-EP

$V_{DD} = 21\text{ V to }33\text{ V}$, $V_{SS} = 0\text{ V}$; $V_{DD} = 10.5\text{ V to }16.5\text{ V}$, $V_{SS} = -10.5\text{ V to }-16.5\text{ V}$; $V_{LOGIC} = 2.7\text{ V to }5.5\text{ V}$, $V_A = V_{DD}$, $V_B = V_{SS}$,
 $-55^\circ\text{C} < T_A < +125^\circ\text{C}$, unless otherwise noted.

Table 1.

Parameter	Symbol	Conditions	Min	Typ ¹	Max	Unit
DC CHARACTERISTICS—RHEOSTAT MODE						
Resolution	N		10			Bits
Resistor Differential Nonlinearity ²	R-DNL	R_{WB} , $V_A = NC$	-1		+1	LSB
Resistor Integral Nonlinearity ²	R-INL	$R_{AB} = 20\text{ k}\Omega$, $ V_{DD} - V_{SS} = 26\text{ V to }33\text{ V}$	-2		+2	LSB
	R-INL	$R_{AB} = 20\text{ k}\Omega$, $ V_{DD} - V_{SS} = 21\text{ V to }26\text{ V}$	-3		+3	LSB
Nominal Resistor Tolerance (R-Perf Mode) ³	$\Delta R_{AB}/R_{AB}$	See Table 2	-1	± 0.5	+1	%
Nominal Resistor Tolerance (Normal Mode) ⁴	$\Delta R_{AB}/R_{AB}$			± 7		%
Resistance Temperature Coefficient	$(\Delta R_{AB}/R_{AB})/\Delta T \times 10^6$	Code = full scale; see Figure 14		35		ppm/°C
Wiper Resistance	R_W	Code = zero scale		60	100	Ω
DC CHARACTERISTICS—POTENTIOMETER DIVIDER MODE						
Resolution	N		10			Bits
Differential Nonlinearity ⁵	DNL		-1		+1	LSB
Integral Nonlinearity ⁵	INL		-2.5		+2.5	LSB
Voltage Divider Temperature Coefficient ⁴	$(\Delta V_W/V_W)/\Delta T \times 10^6$	Code = half scale; see Figure 17		5		ppm/°C
Full-Scale Error	V_{WFSE}	Code = full scale	-8		+1	LSB
Zero-Scale Error	V_{WZSE}	Code = zero scale	0		10	LSB
RESISTOR TERMINALS						
Terminal Voltage Range ⁶	V_A, V_B, V_W		V_{SS}		V_{DD}	V
Capacitance A, Capacitance B ⁴	C_A, C_B	$f = 1\text{ MHz}$, measured to GND, code = half scale		85		pF
Capacitance W ⁴	C_W	$f = 1\text{ MHz}$, measured to GND, code = half scale		65		pF
Common-Mode Leakage Current ⁴	I_{CM}	$V_A = V_B = V_W$	-120	± 1	120	nA
DIGITAL INPUTS						
Input Logic High ⁴	V_{IH}	JEDEC compliant $V_{LOGIC} = 2.7\text{ V to }5.5\text{ V}$	2.0			V
Input Logic Low ⁴	V_{IL}	$V_{LOGIC} = 2.7\text{ V to }5.5\text{ V}$			0.8	V
Input Current	I_{IL}	$V_{IN} = 0\text{ V or }V_{LOGIC}$			± 1	μA
Input Capacitance ⁴	C_{IL}			5		pF
DIGITAL OUTPUTS (SDO and RDY)						
Output High Voltage ⁴	V_{OH}	$R_{PULL_UP} = 2.2\text{ k}\Omega$ to V_{LOGIC}	$V_{LOGIC} - 0.4$			V
Output Low Voltage ⁴	V_{OL}	$R_{PULL_UP} = 2.2\text{ k}\Omega$ to V_{LOGIC}			GND + 0.4	V
Three-State Leakage Current			-1		+1	μA
Output Capacitance ⁴	C_{OL}			5		pF
POWER SUPPLIES						
Single-Supply Power Range	V_{DD}	$V_{SS} = 0\text{ V}$	9		33	V
Dual-Supply Power Range	V_{DD}/V_{SS}		± 9		± 16.5	V
Positive Supply Current	I_{DD}	$V_{DD}/V_{SS} = \pm 16.5\text{ V}$		0.1	2	μA
Negative Supply Current	I_{SS}	$V_{DD}/V_{SS} = \pm 16.5\text{ V}$	-2	-0.1		μA
Logic Supply Range	V_{LOGIC}		2.7		5.5	V
Logic Supply Current	I_{LOGIC}	$V_{LOGIC} = 5\text{ V}$, $V_{IH} = 5\text{ V or }V_{IL} = \text{GND}$		1	10	μA
OTP Store Current ^{4,7}	I_{LOGIC_PROG}	$V_{IH} = 5\text{ V or }V_{IL} = \text{GND}$		25		mA
OTP Read Current ^{4,8}	$I_{LOGIC_FUSE_READ}$	$V_{IH} = 5\text{ V or }V_{IL} = \text{GND}$		25		mA
Power Dissipation ⁹	P_{DISS}	$V_{IH} = 5\text{ V or }V_{IL} = \text{GND}$		8	110	μW
Power Supply Rejection Ratio	PSRR	$\Delta V_{DD}/\Delta V_{SS} = \pm 15\text{ V} \pm 10\%$		0.103		%/%

Parameter	Symbol	Conditions	Min	Typ ¹	Max	Unit
DYNAMIC CHARACTERISTICS ^{5, 10}						
Bandwidth	BW	-3 dB		520		kHz
Total Harmonic Distortion	THD _W	V _A = 1 V rms, V _B = 0 V, f = 1 kHz		-93		dB
V _W Settling Time	t _S	V _A = 30 V, V _B = 0 V, ±0.5 LSB error band, initial code = zero scale, board capacitance = 170 pF				
		Code = full-scale, normal mode		750		ns
		Code = full-scale, R-Perf mode		2.5		μs
		Code = half-scale, normal mode		2.5		μs
		Code = half-scale, R-Perf mode		5		μs
Resistor Noise Density	e _{N, WB}	Code = half-scale, T _A = 25°C, 0 kHz to 200 kHz		10		nV/√Hz

¹ Typical values represent average readings at 25°C, V_{DD} = 15 V, V_{SS} = -15 V, and V_{LOGIC} = 5 V.

² Resistor position nonlinearity error. R-INL is the deviation from an ideal value measured between R_{WB} at Code 0x00B and Code 0x3FF or between R_{WA} at Code 0x3F3 and Code 0x000. R-DNL measures the relative step change from ideal between successive tap positions. The specification is guaranteed in resistor performance mode, with a wiper current of 1 mA for V_A < 12 V and 1.2 mA for V_A ≥ 12 V.

³ Resistor performance mode. The terms resistor performance mode and R-Perf mode are used interchangeably.

⁴ Guaranteed by design and characterization, not subject to production test.

⁵ INL and DNL are measured at V_W with the RDAC configured as a potentiometer divider similar to a voltage output DAC. V_A = V_{DD} and V_B = 0 V. DNL specification limits of ±1 LSB maximum are guaranteed monotonic operating conditions.

⁶ Resistor Terminal A, Resistor Terminal B, and Resistor Terminal W have no limitations on polarity with respect to each other. Dual-supply operation enables ground-referenced bipolar signal adjustment.

⁷ Different from operating current; supply current for fuse program lasts approximately 550 μs.

⁸ Different from operating current; supply current for fuse read lasts approximately 550 μs.

⁹ P_{DISS} is calculated from (I_{DD} × V_{DD}) + (I_{SS} × V_{SS}) + (I_{LOGIC} × V_{LOGIC}).

¹⁰ All dynamic characteristics use V_{DD} = 15 V, V_{SS} = -15 V, and V_{LOGIC} = 5 V.

RESISTOR PERFORMANCE MODE CODE RANGE

Table 2.

Resistor Tolerance per Code	-55°C < T _A < +125°C							
	V _{DD} - V _{SS} = 30 V to 33 V		V _{DD} - V _{SS} = 26 V to 30 V		V _{DD} - V _{SS} = 22 V to 26 V		V _{DD} - V _{SS} = 21 V to 22 V	
	R _{WB}	R _{WA}	R _{WB}	R _{WA}	R _{WB}	R _{WA}	R _{WB}	R _{WA}
1% R-Tolerance	From 0x1EF to 0x3FF	From 0x000 to 0x210	From 0x1F4 to 0x3FF	From 0x000 to 0x20B	From 0x1F4 to 0x3FF	From 0x000 to 0x20B	N/A	N/A
2% R-Tolerance	From 0x0C3 to 0x3FF	From 0x000 to 0x33C	From 0x0E6 to 0x3FF	From 0x000 to 0x319	From 0x131 to 0x3FF	From 0x000 to 0x2CE	From 0x131 to 0x3FF	From 0x000 to 0x2CE
3% R-Tolerance	From 0x073 to 0x3FF	From 0x000 to 0x38C	From 0x087 to 0x3FF	From 0x000 to 0x378	From 0x0AF to 0x3FF	From 0x000 to 0x350	From 0x0AF to 0x3FF	From 0x000 to 0x350

INTERFACE TIMING SPECIFICATIONS

$V_{DD}/V_{SS} = \pm 15\text{ V}$, $V_{LOGIC} = 2.7\text{ V to } 5.5\text{ V}$, $-55^{\circ}\text{C} < T_A < +125^{\circ}\text{C}$. All specifications T_{MIN} to T_{MAX} , unless otherwise noted.

Table 3.

Parameter	Limit ¹	Unit	Description
t_1^2	20	ns min	SCLK cycle time
t_2	10	ns min	SCLK high time
t_3	10	ns min	SCLK low time
t_4	10	ns min	$\overline{\text{SYNC}}$ to SCLK falling edge setup time
t_5	5	ns min	Data setup time
t_6	5	ns min	Data hold time
t_7	1	ns min	SCLK falling edge to $\overline{\text{SYNC}}$ rising edge
t_8	400 ³	ns min	Minimum $\overline{\text{SYNC}}$ high time
t_9	14	ns min	$\overline{\text{SYNC}}$ rising edge to next SCLK fall ignore
t_{10}^4	1	ns min	RDY rising edge to $\overline{\text{SYNC}}$ falling edge
t_{11}^4	40	ns max	$\overline{\text{SYNC}}$ rising edge to RDY fall time
t_{12}^4	2.4	$\mu\text{s max}$	RDY low time, RDAC register write command execute time (R-Perf mode)
t_{12}^4	410	ns max	RDY low time, RDAC register write command execute time (normal mode)
t_{12}^4	8	ms max	RDY low time, memory program execute time
t_{12}^4	1.5	ms min	Software/hardware reset
t_{13}^4	450	ns max	RDY low time, RDAC register readback execute time
t_{13}^4	1.3	ms max	RDY low time, memory readback execute time
t_{14}^4	450	ns max	SCLK rising edge to SDO valid
t_{RESET}	20	ns min	Minimum $\overline{\text{RESET}}$ pulse width (asynchronous)
$t_{\text{POWER-UP}}^5$	2	ms max	Power-on OTP restore time

¹ All input signals are specified with $t_r = t_f = 1\text{ ns/V}$ (10% to 90% of V_{DD}) and timed from a voltage level of $(V_{IL} + V_{IH})/2$.

² Maximum SCLK frequency is 50 MHz.

³ Refer to t_{12} and t_{13} for RDAC register and memory commands operations.

⁴ $R_{\text{PULL-UP}} = 2.2\text{ k}\Omega$ to V_{LOGIC} , with a capacitance load of 168 pF.

⁵ Maximum time after V_{LOGIC} is equal to 2.5 V.

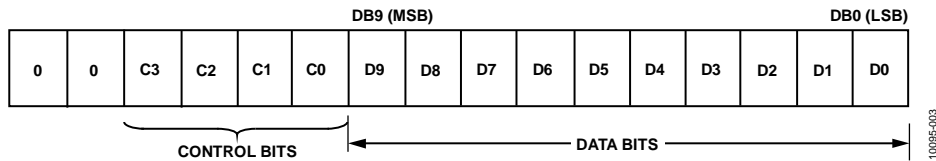

Figure 2. Shift Register Content

100095-003

Timing Diagrams

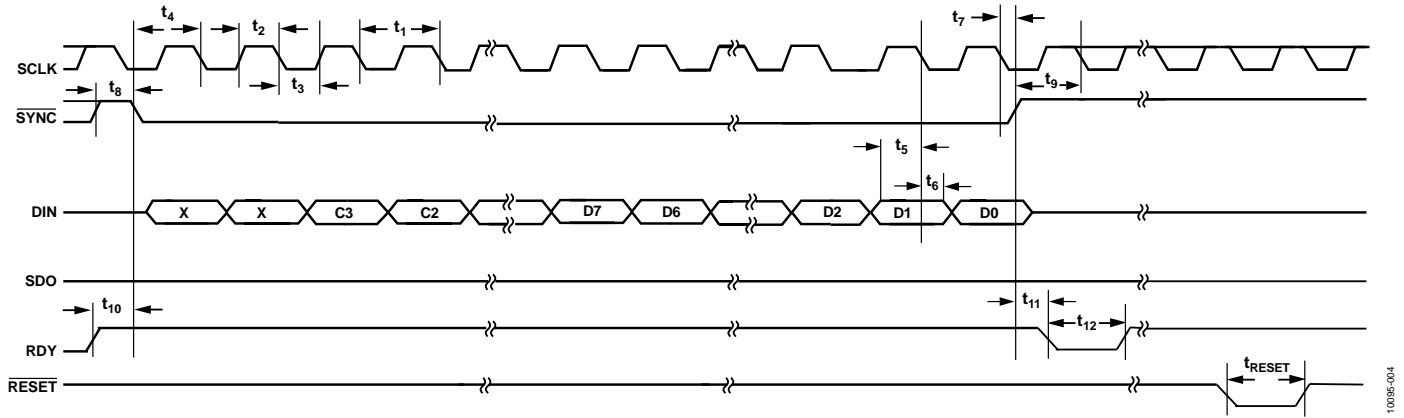

Figure 3. Write Timing Diagram, CPOL = 0, CPHA = 1

10095-004

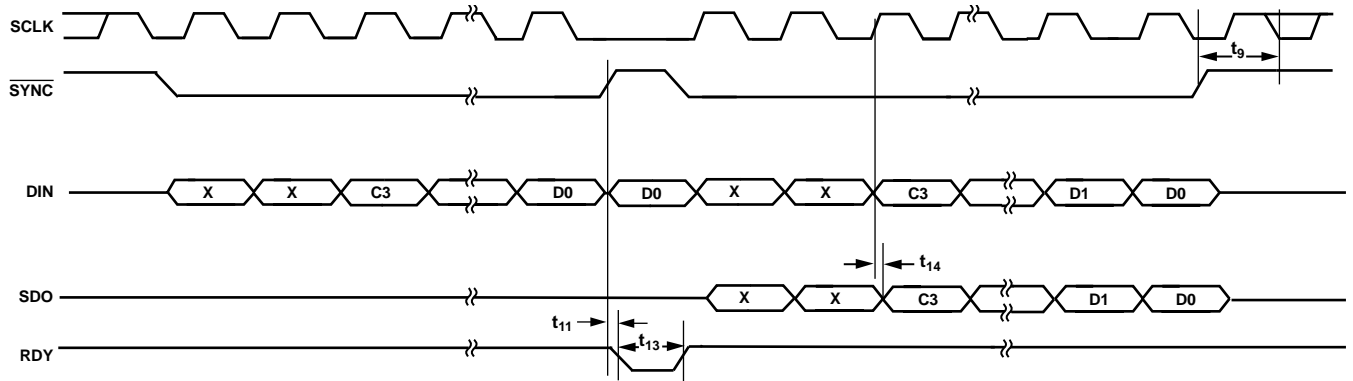

Figure 4. Read Timing Diagram, CPOL = 0, CPHA = 1

10095-005

ABSOLUTE MAXIMUM RATINGS

$T_A = 25^\circ\text{C}$, unless otherwise noted.

Table 4.

Parameter	Rating
V_{DD} to GND	-0.3 V to +35 V
V_{SS} to GND	+0.3 V to -25 V
V_{LOGIC} to GND	-0.3 V to +7 V
V_{DD} to V_{SS}	35 V
V_A, V_B, V_W to GND	$V_{SS} - 0.3\text{ V}, V_{DD} + 0.3\text{ V}$
Digital Input and Output Voltage to GND	-0.3 V to $V_{LOGIC} + 0.3\text{ V}$
EXT_CAP Voltage to GND	-0.3 V to +7 V
I_A, I_B, I_W	
Continuous	$\pm 3\text{ mA}$
Pulsed ¹	
Frequency > 10 kHz	$\pm 3/d^2$
Frequency $\leq 10\text{ kHz}$	$\pm 3/\sqrt{d^2}$
Operating Temperature Range ³	-55°C to $+125^\circ\text{C}$
Maximum Junction Temperature (T_J max)	150°C
Storage Temperature Range	-65°C to $+150^\circ\text{C}$
Reflow Soldering	
Peak Temperature	260°C
Time at Peak Temperature	20 sec to 40 sec
Package Power Dissipation	$(T_J \text{ max} - T_A)/\theta_{JA}$

¹ Maximum terminal current is bounded by the maximum current handling of the switches, maximum power dissipation of the package, and maximum applied voltage across any two of the A, B, and W terminals at a given resistance.

² Pulse duty factor.

³ Includes programming of OTP memory.

Stresses at or above those listed under Absolute Maximum Ratings may cause permanent damage to the product. This is a stress rating only; functional operation of the product at these or any other conditions above those indicated in the operational section of this specification is not implied. Operation beyond the maximum operating conditions for extended periods may affect product reliability.

THERMAL RESISTANCE

θ_{JA} is defined by JEDEC specification JESD-51 and the value is dependent on the test board and test environment.

Table 5. Thermal Resistance

Package Type	θ_{JA}	θ_{JC}	Unit
14-Lead TSSOP	93 ¹	20	$^\circ\text{C}/\text{W}$

¹ JEDEC 2S2P test board, still air (0 m/sec to 1 m/sec air flow).

ESD CAUTION



ESD (electrostatic discharge) sensitive device. Charged devices and circuit boards can discharge without detection. Although this product features patented or proprietary protection circuitry, damage may occur on devices subjected to high energy ESD. Therefore, proper ESD precautions should be taken to avoid performance degradation or loss of functionality.

PIN CONFIGURATION AND FUNCTION DESCRIPTIONS

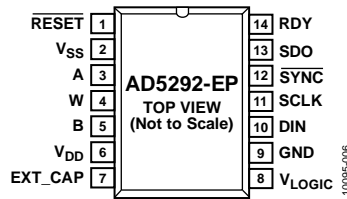

Figure 5. Pin Configuration

Table 6. Pin Function Descriptions

Pin No.	Mnemonic	Description
1	RESET	Hardware Reset Pin. Refreshes the RDAC register with the contents of the 20-TP memory register. Factory default loads midscale until the first 20-TP wiper memory location is programmed. RESET is activated at the logic high transition. Tie RESET to V _{LOGIC} if not used.
2	V _{SS}	Negative Supply. Connect to 0 V for single-supply applications. This pin should be decoupled with 0.1 μF ceramic capacitors and 10 μF capacitors.
3	A	Terminal A of RDAC. $V_{SS} \leq V_A \leq V_{DD}$.
4	W	Wiper Terminal of RDAC. $V_{SS} \leq V_W \leq V_{DD}$.
5	B	Terminal B of RDAC. $V_{SS} \leq V_B \leq V_{DD}$.
6	V _{DD}	Positive Power Supply. This pin should be decoupled with 0.1 μF ceramic capacitors and 10 μF capacitors.
7	EXT_CAP	External Capacitor. Connect a 1 μF capacitor to EXT_CAP. This capacitor must have a voltage rating of ≥7 V.
8	V _{LOGIC}	Logic Power Supply; 2.7 V to 5.5 V. This pin should be decoupled with 0.1 μF ceramic capacitors and 10 μF capacitors.
9	GND	Ground Pin, Logic Ground Reference.
10	DIN	Serial Data Input. The AD5292-EP has a 16-bit shift register. Data is clocked into the register on the falling edge of the serial clock input.
11	SCLK	Serial Clock Input. Data is clocked into the shift register on the falling edge of the serial clock input. Data can be transferred at rates up to 50 MHz.
12	SYNC	Falling Edge Synchronization Signal. This is the frame synchronization signal for the input data. When SYNC goes low, it enables the shift register and data is transferred in on the falling edges of the following clocks. The selected register is updated on the rising edge of SYNC following the 16 th clock cycle. If SYNC is taken high before the 16 th clock cycle, the rising edge of SYNC acts as an interrupt, and the write sequence is ignored by the DAC.
13	SDO	Serial Data Output. This open-drain output requires an external pull-up resistor. SDO can be used to clock data from the shift register in daisy-chain mode or in readback mode.
14	RDY	Ready Pin. This active-high open-drain output identifies the completion of a write or read operation to or from the RDAC register or memory.

TYPICAL PERFORMANCE CHARACTERISTICS

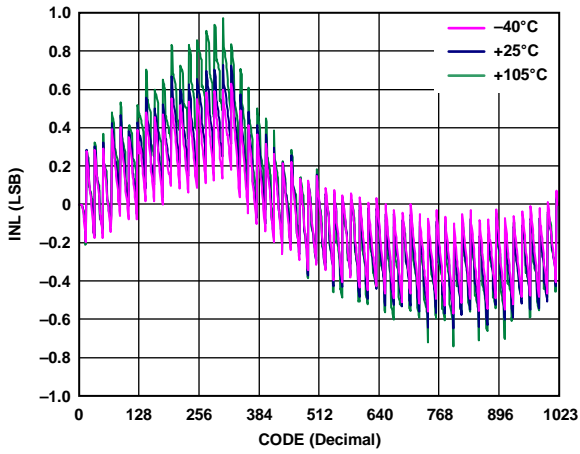

Figure 6. R-INL in R-Perf Mode vs. Code

10095-106

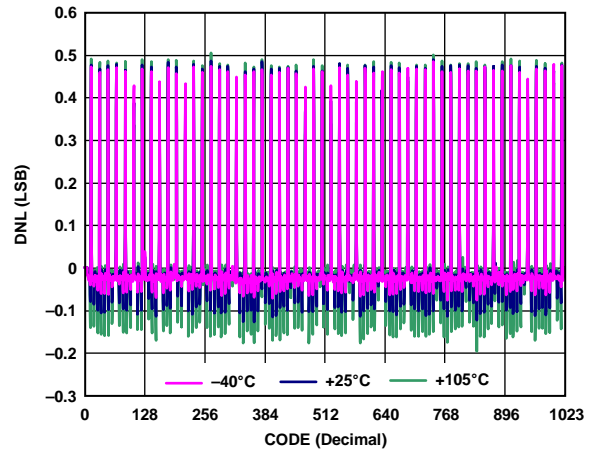

Figure 9. R-DNL in R-Perf Mode vs. Code

10095-007

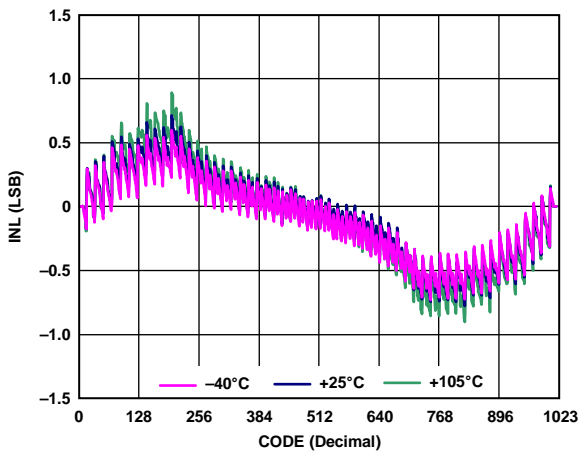

Figure 7. INL in R-Perf Mode vs. Code

10095-014

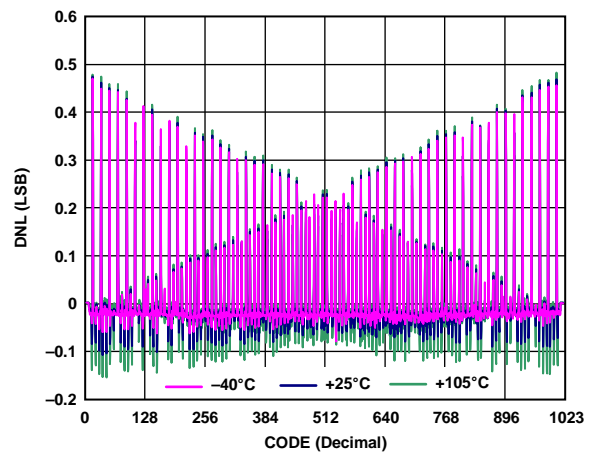

Figure 10. DNL in R-Perf Mode vs. Code

10095-015

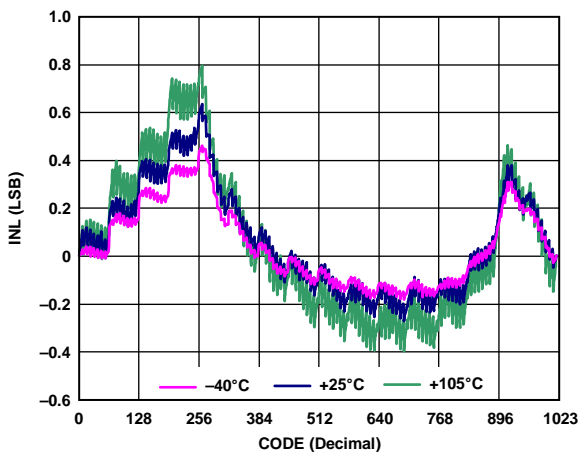

Figure 8. R-INL in Normal Mode vs. Code

10095-010

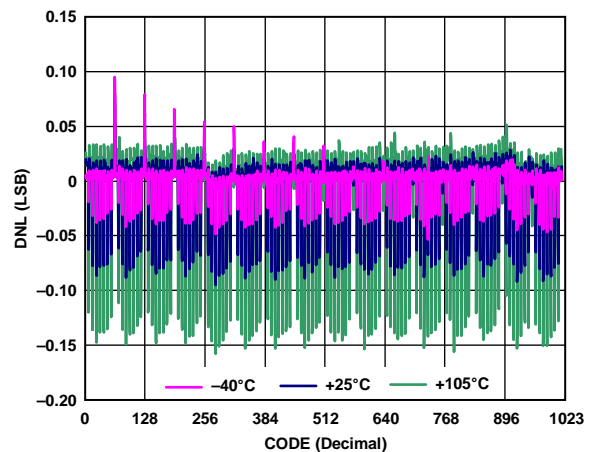

Figure 11. R-DNL in Normal Mode vs. Code

10095-011

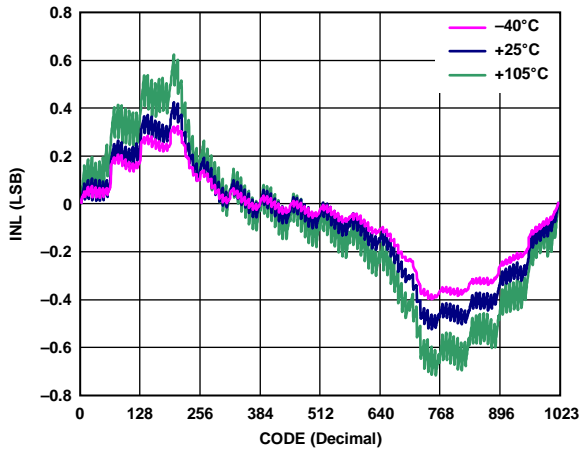

Figure 12. INL in Normal Mode vs. Code

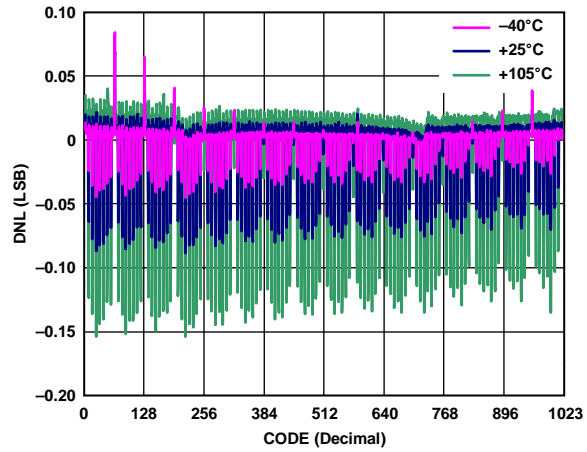

Figure 15. DNL in Normal Mode vs. Code

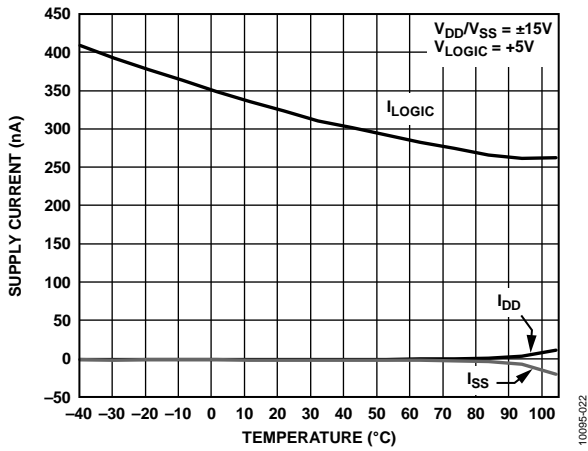

Figure 13. Supply Current (I_{DD} , I_{SS} , I_{LOGIC}) vs. Temperature

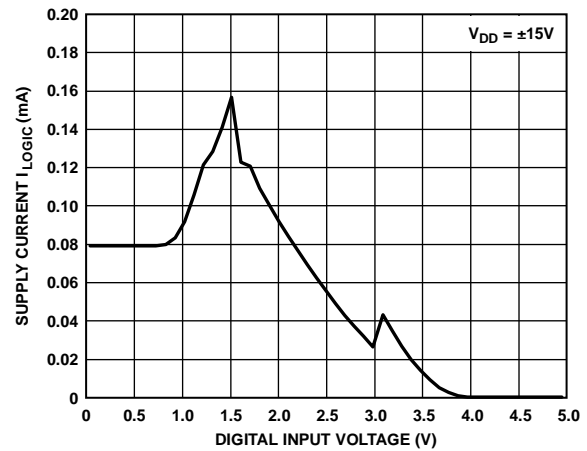

Figure 16. Supply Current I_{LOGIC} vs. Digital Input Voltage

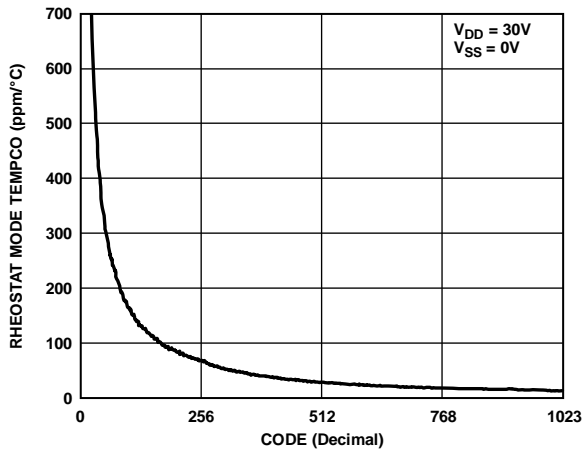

Figure 14. Rheostat Mode Tempco $\Delta R_{WB}/\Delta T$ vs. Code

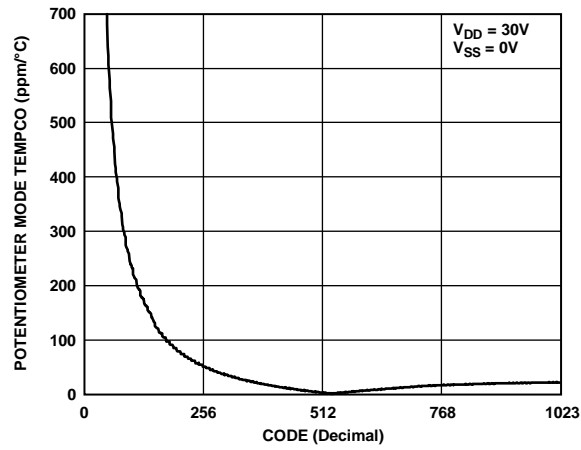

Figure 17. Potentiometer Mode Tempco $\Delta R_{WB}/\Delta T$ vs. Code

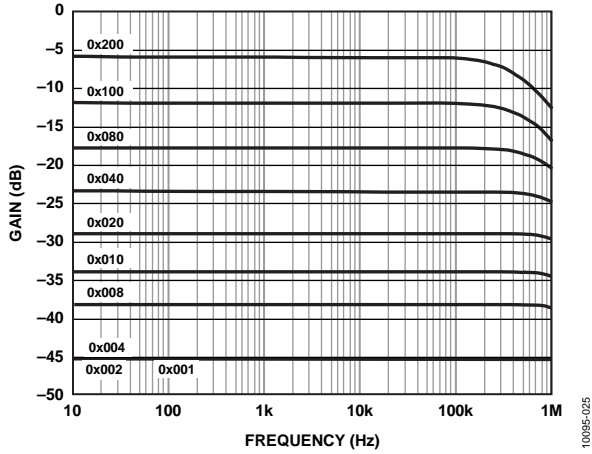

Figure 18. 20 kΩ Gain vs. Frequency vs. Code

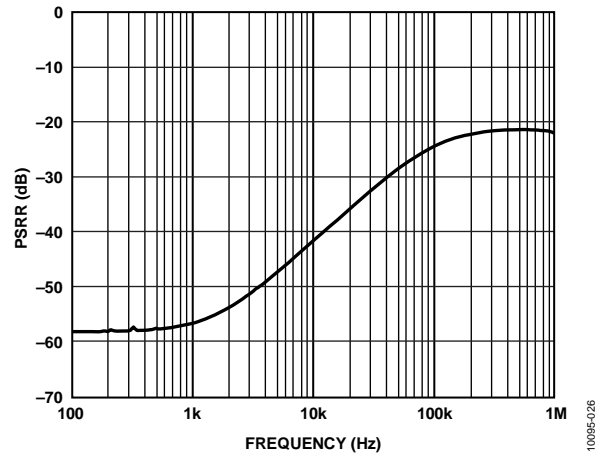

Figure 21. Power Supply Rejection Ratio vs. Frequency

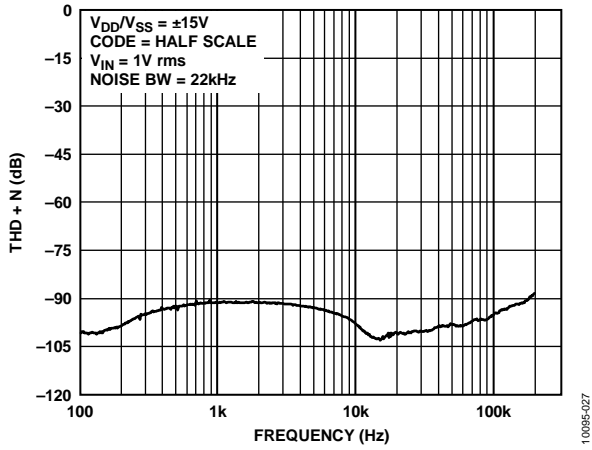

Figure 19. THD + Noise vs. Frequency

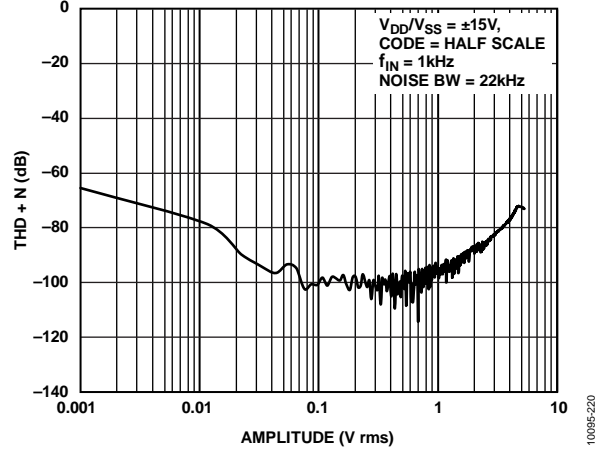

Figure 22. THD + Noise vs. Amplitude

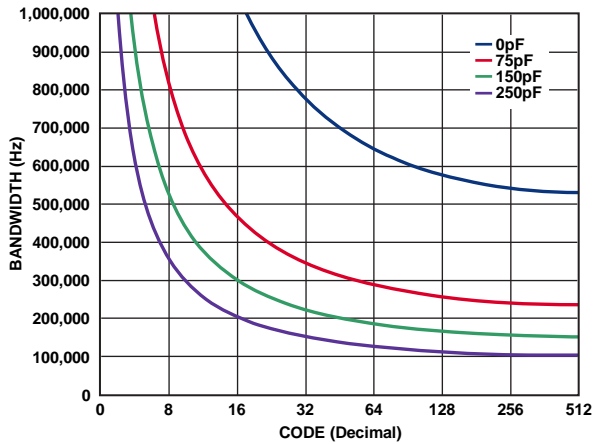

Figure 20. Bandwidth vs. Code vs. Net Capacitance

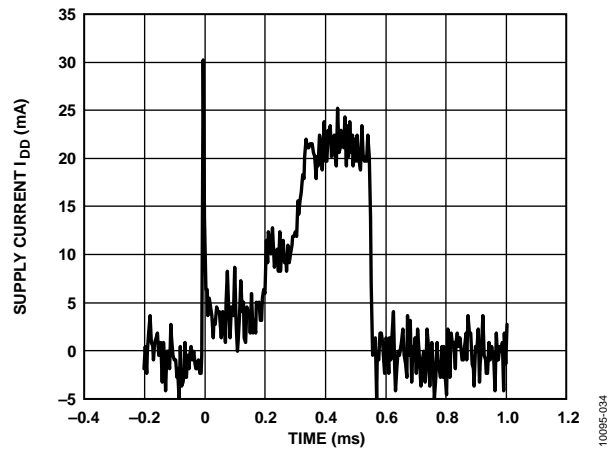

Figure 23. I_{DD} Waveform While Blowing/Reading Fuse

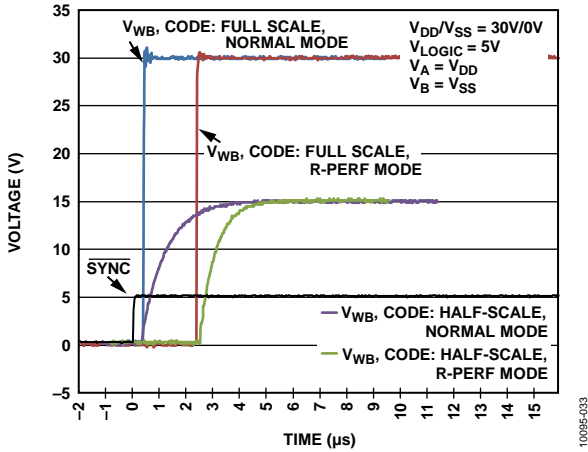

Figure 24. Large-Signal Settling Time from Code Zero Scale

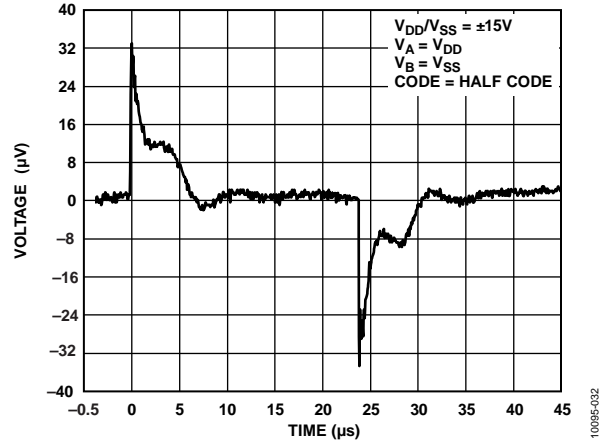

Figure 27. Digital Feedthrough

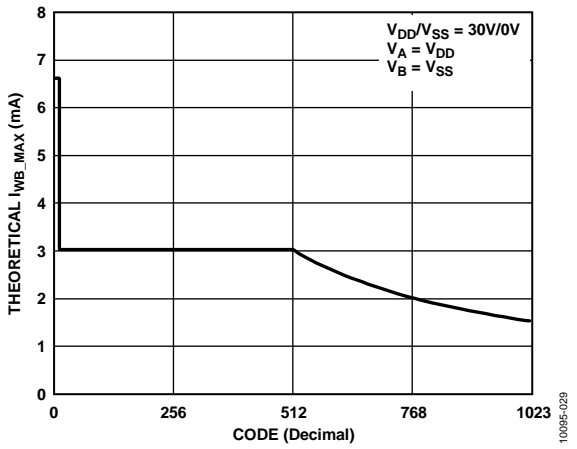

Figure 25. Theoretical Maximum Current vs. Code

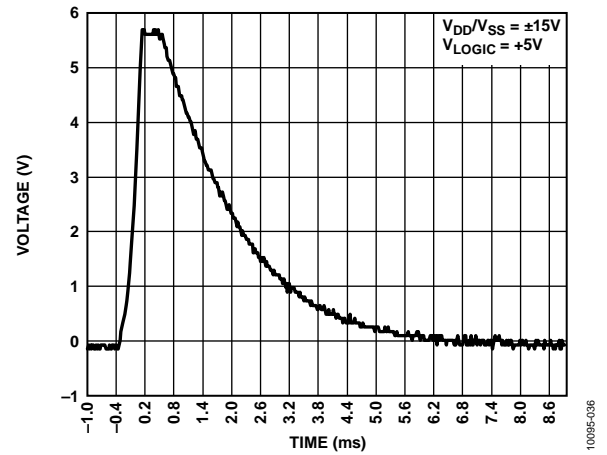

Figure 28. V_{EXT_CAP} Waveform While Reading Fuse Or Calibration

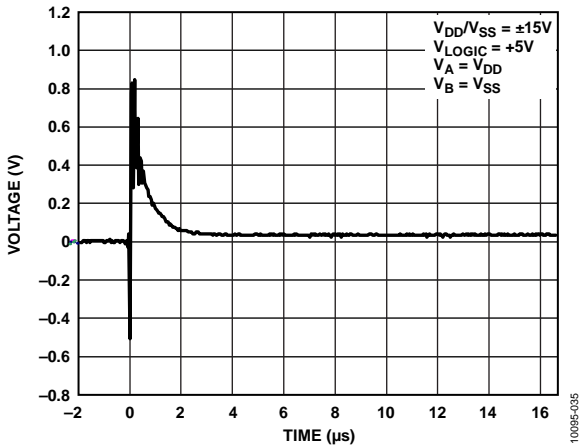

Figure 26. Maximum Transition Glitch

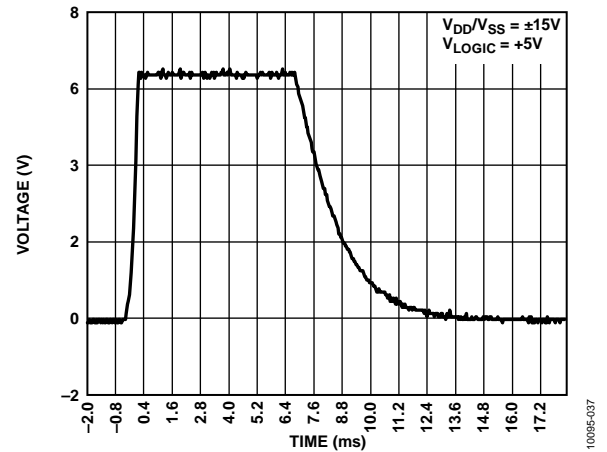

Figure 29. V_{EXT_CAP} Waveform While Writing Fuse

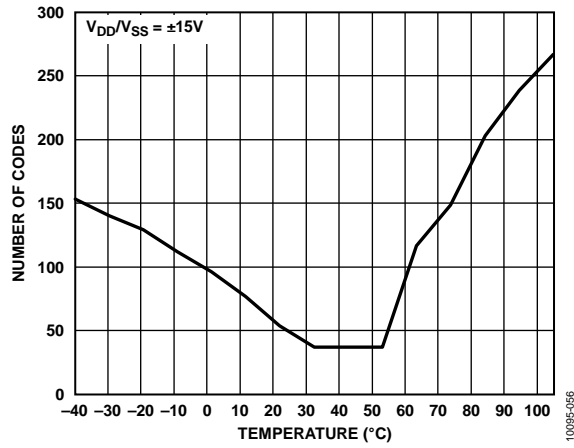

Figure 30. Code Range > 1% R-Tolerance Error vs. Temperature

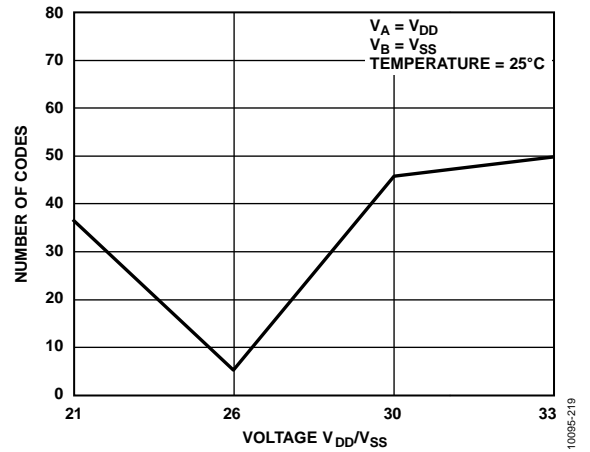

Figure 31. Code Range > 1% R-Tolerance Error vs. Voltage

TEST CIRCUITS

Figure 32 to Figure 37 define the test conditions used in the Specifications section.

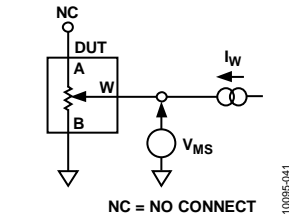

Figure 32. Resistor Position Nonlinearity Error (Rheostat Operation; R-INL, R-DNL)

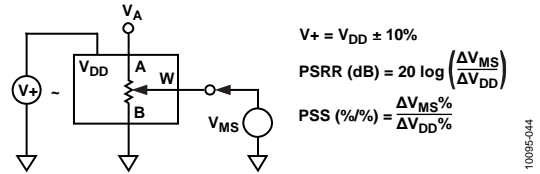

Figure 35. Power Supply Sensitivity (PSS, PSRR)

$$V_+ = V_{DD} \pm 10\%$$

$$PSRR \text{ (dB)} = 20 \log \left(\frac{\Delta V_{MS}}{\Delta V_{DD}} \right)$$

$$PSS \text{ (\%/%) } = \frac{\Delta V_{MS}\%}{\Delta V_{DD}\%}$$

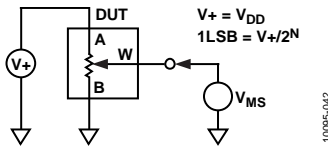

Figure 33. Potentiometer Divider Nonlinearity Error (INL, DNL)

$$V_+ = V_{DD}$$

$$1LSB = V_+/2^N$$

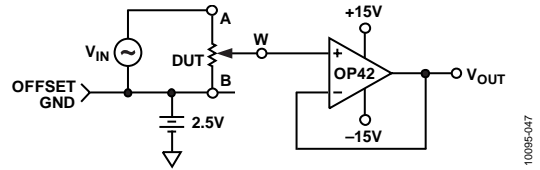

Figure 36. Gain vs. Frequency

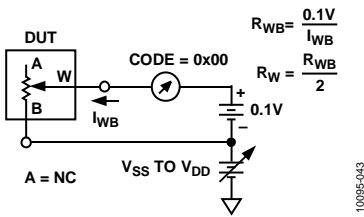

Figure 34. Wiper Resistance

$$R_{WB} = \frac{0.1V}{I_{WB}}$$

$$R_W = \frac{R_{WB}}{2}$$

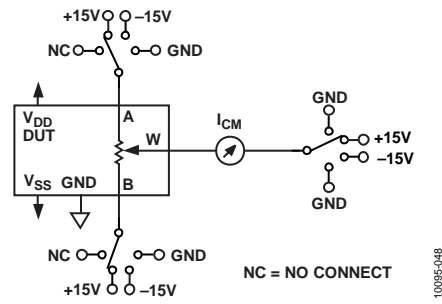
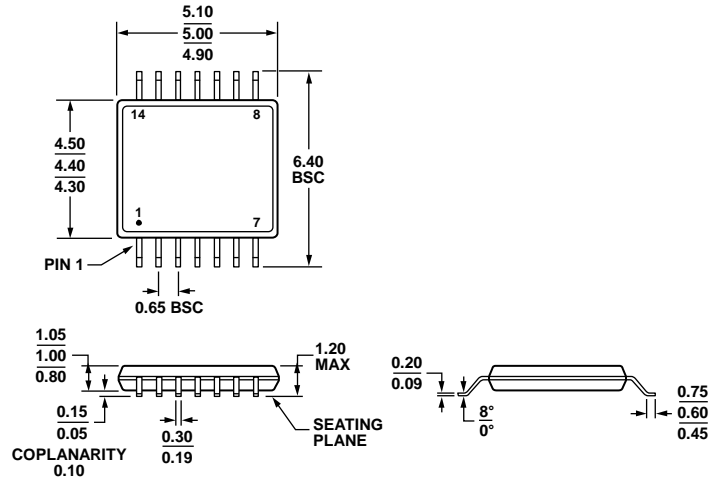

Figure 37. Common-Mode Leakage Current

OUTLINE DIMENSIONS



COMPLIANT TO JEDEC STANDARDS MO-153-AB-1

Figure 38. 14-Lead Thin Shrink Small Outline Package [TSSOP] (RU-14)
 Dimensions shown in millimeters

061908-A

ORDERING GUIDE

Model ¹	R _{AB} (kΩ)	Resolution	Memory	Temperature Range	Package Description	Package Option
AD5292SRU-20-EP	20	1024	20-TP	-55°C to +125°C	14-Lead TSSOP	RU-14
AD5292SRUZ-20-EP	20	1024	20-TP	-55°C to +125°C	14-Lead TSSOP	RU-14

¹ Z = RoHS Compliant Part.

NOTES

X-ON Electronics

Largest Supplier of Electrical and Electronic Components

Click to view similar products for [Digital Potentiometer ICs](#) category:

Click to view products by [Analog Devices](#) manufacturer:

Other Similar products are found below :

[604-00010](#) [CAT5111VI-10-GT3](#) [CAT5110TBI-10GT3](#) [CAT5111LI-10-G](#) [X9C103S](#) [CAT5110TBI-50GT3](#) [CAT5112ZI-50-GT3](#)
[CAT5111YI-10-GT3](#) [MCP4351-502E/ML](#) [MCP4641-502E/ST](#) [MCP4162-103E/SN](#) [MCP4451-103E/ML](#) [MCP4451-502E/ST](#) [MCP4532T-103E/MF](#) [MCP4631-503E/ST](#) [MCP4661-502E/ST](#) [CAT5113VI-00-GT3](#) [MCP4641T-502E/ML](#) [MCP4021-103E/MS](#) [MAX5387LAUD+DS1855E-010+](#) [MAX5160LEUA+T](#) [MCP4142-104E/MF](#) [AD5260BRUZ200-RL7](#) [CAT5113LI-10-G](#) [CAT5113LI-50-G](#) [CAT5114LI-00-G](#)
[AD5245BRJZ5-R2](#) [AD5116BCPZ10-500R7](#) [AD5116BCPZ5-500R7](#) [AD5116BCPZ80-500R7](#) [AD5122ABCPZ100-RL7](#) [AD5122ABRUZ100](#)
[AD5122BCPZ10-RL7](#) [AD5143BCPZ10-RL7](#) [AD5253BRUZ10](#) [AD5253BRUZ50](#) [AD5254BRUZ1-RL7](#) [AD5144TRUZ10-EP](#)
[AD5160BRJZ100-RL7](#) [AD5160BRJZ10-RL7](#) [AD5161BRMZ10](#) [AD5161BRMZ100](#) [AD5161BRMZ5](#) [AD5161BRMZ5-RL7](#)
[AD5170BRMZ2.5-RL7](#) [AD5162WBRMZ100-RL7](#) [AD5165BUJZ100-R2](#) [AD5165BUJZ100-R7](#) [AD5170BRMZ10](#)