

FEATURES

- High relative accuracy (INL): ±2 LSB maximum at 16 bits**
- Low drift 2.5 V reference: 2 ppm/°C typical**
- Tiny package: 3 mm × 3 mm, 16-lead LFCSP**
- Total unadjusted error (TUE): ±0.1% of FSR maximum**
- Offset error: ±1.5 mV maximum**
- Gain error: ±0.1% of FSR maximum**
- High drive capability: 20 mA, 0.5 V from supply rails**
- User selectable gain of 1 or 2 (GAIN pin)**
- Reset to zero scale or midscale (RSTSEL pin)**
- 1.8 V logic compatibility**
- 50 MHz SPI with readback or daisy chain**
- Low glitch: 0.5 nV-sec**
- Low power: 3.3 mW at 3 V**
- 2.7 V to 5.5 V power supply**
- −40°C to +105°C temperature range**

APPLICATIONS

- Optical transceivers
- Base-station power amplifiers
- Process control (PLC I/O cards)
- Industrial automation
- Data acquisition systems

GENERAL DESCRIPTION

The [AD5686R/AD5685R/AD5684R](#), members of the *nano*DAC+® family, are low power, quad, 16-/14-/12-bit buffered voltage output DACs. The devices include a 2.5 V, 2 ppm/°C internal reference (enabled by default) and a gain select pin giving a full-scale output of 2.5 V (gain = 1) or 5 V (gain = 2). All devices operate from a single 2.7 V to 5.5 V supply, are guaranteed monotonic by design, and exhibit less than 0.1% FSR gain error and 1.5 mV offset error performance. The devices are available in a 3 mm × 3 mm LFCSP and a TSSOP package.

The [AD5686R/AD5685R/AD5684R](#) also incorporate a power-on reset circuit and a RSTSEL pin that ensures that the DAC outputs power up to zero scale or midscale and remains there until a valid write takes place. Each part contains a per-channel power-down feature that reduces the current consumption of the device to 4 μA at 3 V while in power-down mode.

The [AD5686R/AD5685R/AD5684R](#) employ a versatile SPI interface that operates at clock rates up to 50 MHz, and all devices contain a V_{LOGIC} pin intended for 1.8 V/3 V/5 V logic.

FUNCTIONAL BLOCK DIAGRAM

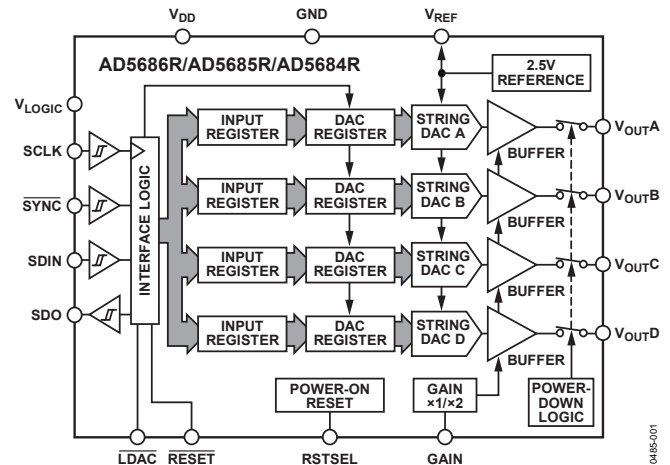

Figure 1.

 Table 1. Quad *nano*DAC+ Devices

Interface	Reference	16-Bit	14-Bit	12-Bit
SPI	Internal	AD5686R	AD5685R	AD5684R
	External	AD5686		AD5684
I ² C	Internal	AD5696R	AD5695R	AD5694R
	External	AD5696		AD5694

PRODUCT HIGHLIGHTS

- High Relative Accuracy (INL).
[AD5686R](#) (16-bit): ±2 LSB maximum
[AD5685R](#) (14-bit): ±1 LSB maximum
[AD5684R](#) (12-bit): ±1 LSB maximum
- Low Drift 2.5 V On-Chip Reference.
 2 ppm/°C typical temperature coefficient
 5 ppm/°C maximum temperature coefficient
- Two Package Options.
 3 mm × 3 mm, 16-lead LFCSP
 16-lead TSSOP

TABLE OF CONTENTS

Features	1	Write and Update Commands	22
Applications	1	Daisy-Chain Operation	23
Functional Block Diagram	1	Readback Operation	23
General Description	1	Power-Down Operation.....	24
Product Highlights	1	Load DAC (Hardware $\overline{\text{LDAC}}$ Pin)	25
Revision History	2	$\overline{\text{LDAC}}$ Mask Register	25
Specifications	3	Hardware Reset ($\overline{\text{RESET}}$).....	26
AC Characteristics	5	Reset Select Pin (RSTSEL)	26
Timing Characteristics	6	Internal Reference Setup	26
Daisy-Chain and Readback Timing Characteristics	7	Solder Heat Reflow	26
Absolute Maximum Ratings	9	Thermal Hysteresis	27
ESD Caution.....	9	Long-Term Temperature Drift	27
Pin Configuration and Function Descriptions	10	Applications Information	28
Typical Performance Characteristics.....	11	Microprocessor Interfacing	28
Terminology.....	18	AD5686R/AD5685R/AD5684R to ADSP-BF531 Interface .	28
Theory of Operation	20	AD5686R/AD5685R/AD5684R to SPORT Interface.....	28
Digital-to-Analog Converter	20	Layout Guidelines	28
Transfer Function	20	Galvanically Isolated Interface	29
DAC Architecture	20	Outline Dimensions.....	30
Serial Interface	21	Ordering Guide	31
Standalone Operation.....	22		

REVISION HISTORY

8/2020—Rev. D to Rev. E

Changes to Readback Operation Section.....	23
Changes to $\overline{\text{LDAC}}$ Mask Register Section.....	25
Changes to Hardware Reset ($\overline{\text{RESET}}$) Section	26
Updated Outline Dimensions.....	30
Changes to Ordering Guide.....	31

1/2017—Rev. C to Rev. D

Changes to Features Section	1
Changes to V_{LOGIC} Parameter, Table 2	4
Changes to Output Noise Spectral Density Parameter, Table 3	5
Changes to Table 4 and Figure 2	6
Changes to Table 5 and Figure 4.....	7
Changes to Figure 5.....	8
Changes to Table 6	9
Changes to $\overline{\text{RESET}}$ Pin Description, Table 7.....	10
Changes to Table 8	21
Changes to Readback Operation Section.....	23

Changes to Hardware Reset ($\overline{\text{RESET}}$) Section	26
Added Long-Term Temperature Drift Section and Figure 58	27

5/2014—Rev. B to Rev. C.

Deleted Long-Term Stability/Drift Parameter, Table 1.....	4
Deleted Figure 11; Renumbered Sequentially	11
Deleted Long-Term Temperature Drift Section and Figure 58; Renumbered Sequentially	26

6/2013—Rev. A to Rev. B

Changes to Pin GAIN and Pin RSTSEL Descriptions; Table 6 ..	10
---	----

9/2012—Rev. 0 to Rev. A

Changes to Table 1	1
Changes to Figure 13	11
Changes to Figure 36	15

4/2012—Revision 0: Initial Version

SPECIFICATIONS

$V_{DD} = 2.7\text{ V to }5.5\text{ V}$; $1.62\text{ V} \leq V_{LOGIC} \leq 5.5\text{ V}$; all specifications T_{MIN} to T_{MAX} , unless otherwise noted. $R_L = 2\text{ k}\Omega$; $C_L = 200\text{ pF}$.

Table 2.

Parameter	A Grade ¹			B Grade ¹			Unit	Test Conditions/Comments
	Min	Typ	Max	Min	Typ	Max		
STATIC PERFORMANCE ²								
AD5686R								
Resolution	16			16			Bits	
Relative Accuracy		± 2	± 8		± 1	± 2	LSB	Gain = 2
		± 2	± 8		± 1	± 3		Gain = 1
Differential Nonlinearity			± 1			± 1	LSB	Guaranteed monotonic by design
AD5685R								
Resolution	14			14			Bits	
Relative Accuracy		± 0.5	± 4		± 0.5	± 1	LSB	
Differential Nonlinearity			± 1			± 1	LSB	Guaranteed monotonic by design
AD5684R								
Resolution	12			12			Bits	
Relative Accuracy		± 0.12	± 2		± 0.12	± 1	LSB	
Differential Nonlinearity			± 1			± 1	LSB	Guaranteed monotonic by design
Zero-Code Error		0.4	4		0.4	1.5	mV	All zeros loaded to DAC register
Offset Error		+0.1	± 4		+0.1	± 1.5	mV	
Full-Scale Error		+0.01	± 0.2		+0.01	± 0.1	% of FSR	All ones loaded to DAC register
Gain Error		± 0.02	± 0.2		± 0.02	± 0.1	% of FSR	
Total Unadjusted Error		± 0.01	± 0.25		± 0.01	± 0.1	% of FSR	External reference; gain = 2; TSSOP
			± 0.25			± 0.2	% of FSR	Internal reference; gain = 1; TSSOP
Offset Error Drift ³		± 1			± 1		$\mu\text{V}/^\circ\text{C}$	
Gain Temperature Coefficient ³		± 1			± 1		ppm	Of FSR/ $^\circ\text{C}$
DC Power Supply Rejection Ratio ³		0.15			0.15		mV/V	DAC code = midscale; $V_{DD} = 5\text{ V} \pm 10\%$
DC Crosstalk ³							μV	Due to single channel, full-scale output change
		± 2			± 2		$\mu\text{V}/\text{mA}$	Due to load current change
		± 3			± 3		μV	Due to powering down (per channel)
		± 2			± 2		μV	
OUTPUT CHARACTERISTICS ³								
Output Voltage Range	0		V_{REF}	0		V_{REF}	V	Gain = 1
	0		$2 \times V_{REF}$	0		$2 \times V_{REF}$	V	Gain = 2, see Figure 33
Capacitive Load Stability		2			2		nF	$R_L = \infty$
		10			10		nF	$R_L = 1\text{ k}\Omega$
Resistive Load ⁴	1			1			k Ω	
Load Regulation		80			80		$\mu\text{V}/\text{mA}$	$5\text{ V} \pm 10\%$, DAC code = midscale; $-30\text{ mA} \leq I_{OUT} \leq 30\text{ mA}$
		80			80		$\mu\text{V}/\text{mA}$	$3\text{ V} \pm 10\%$, DAC code = midscale; $-20\text{ mA} \leq I_{OUT} \leq 20\text{ mA}$
Short-Circuit Current ⁵		40			40		mA	
Load Impedance at Rails ⁶		25			25		Ω	See Figure 33
Power-Up Time		2.5			2.5		μs	Coming out of power-down mode; $V_{DD} = 5\text{ V}$

Parameter	A Grade ¹			B Grade ¹			Unit	Test Conditions/Comments
	Min	Typ	Max	Min	Typ	Max		
REFERENCE OUTPUT								
Output Voltage ⁷	2.4975		2.5025	2.4975		2.5025	V	At ambient
Reference TC ^{8,9}		5	20		2	5	ppm/°C	See the Terminology section
Output Impedance ³		0.04			0.04		Ω	
Output Voltage Noise ³		12			12		μV p-p	0.1 Hz to 10 Hz
Output Voltage Noise Density ³		240			240		nV/√Hz	At ambient; f = 10 kHz, C _L = 10 nF
Load Regulation Sourcing ³		20			20		μV/mA	At ambient
Load Regulation Sinking ³		40			40		μV/mA	At ambient
Output Current Load Capability ³		±5			±5		mA	V _{DD} ≥ 3 V
Line Regulation ³		100			100		μV/V	At ambient
Thermal Hysteresis ³		125			125		ppm	First cycle
		25			25		ppm	Additional cycles
LOGIC INPUTS ³								
Input Current			±2			±2	μA	Per pin
V _{INL} , Input Low Voltage			0.3 × V _{LOGIC}			0.3 × V _{LOGIC}	V	
V _{INH} , Input High Voltage	0.7 × V _{LOGIC}			0.7 × V _{LOGIC}			V	
Pin Capacitance		2			2		pF	
LOGIC OUTPUTS (SDO) ³								
Output Low Voltage, V _{OL}			0.4			0.4	V	I _{SINK} = 200 μA
Output High Voltage, V _{OH}	V _{LOGIC} - 0.4			V _{LOGIC} - 0.4			V	I _{SOURCE} = 200 μA
Floating State Output Capacitance		4			4		pF	
POWER REQUIREMENTS								
V _{LOGIC}	1.62		5.5	1.62		5.5	V	
I _{LOGIC}			3			3	μA	
V _{DD}	2.7		5.5	2.7		5.5	V	Gain = 1
V _{DD}	V _{REF} + 1.5		5.5	V _{REF} + 1.5		5.5	V	Gain = 2
I _{DD}								V _{IH} = V _{DD} , V _{IL} = GND, V _{DD} = 2.7 V to 5.5 V
Normal Mode ¹⁰		0.59	0.7		0.59	0.7	mA	Internal reference off
		1.1	1.3		1.1	1.3	mA	Internal reference on, at full scale
All Power-Down Modes ¹¹		1	4		1	4	μA	-40°C to +85°C
			6			6	μA	-40°C to +105°C

¹ Temperature range: A and B grade: -40°C to +105°C.

² DC specifications tested with the outputs unloaded, unless otherwise noted. Upper dead band = 10 mV and exists only when V_{REF} = V_{DD} with gain = 1 or when V_{REF}/2 = V_{DD} with gain = 2. Linearity calculated using a reduced code range of 256 to 65,280 (AD5686R), 64 to 16,320 (AD5685R), and 12 to 4080 (AD5684R).

³ Guaranteed by design and characterization; not production tested.

⁴ Channel A and Channel B can have a combined output current of up to 30 mA. Similarly, Channel C and Channel D can have a combined output current of up to 30 mA up to a junction temperature of 110°C.

⁵ V_{DD} = 5 V. The device includes current limiting that is intended to protect the device during temporary overload conditions. Junction temperature can be exceeded during current limit. Operation above the specified maximum operation junction temperature may impair device reliability.

⁶ When drawing a load current at either rail, the output voltage headroom with respect to that rail is limited by the 25 Ω typical channel resistance of the output devices. For example, when sinking 1 mA, the minimum output voltage = 25 Ω × 1 mA = 25 mV (see Figure 33).

⁷ Initial accuracy presolder reflow is ±750 μV; output voltage includes the effects of preconditioning drift. See the Internal Reference Setup section.

⁸ Reference is trimmed and tested at two temperatures and is characterized from -40°C to +105°C.

⁹ Reference temperature coefficient calculated as per the box method. See the Terminology section for further information.

¹⁰ Interface inactive. All DACs active. DAC outputs unloaded.

¹¹ All DACs powered down.

AC CHARACTERISTICS

$V_{DD} = 2.7\text{ V to }5.5\text{ V}$; $R_L = 2\text{ k}\Omega\text{ to GND}$; $C_L = 200\text{ pF to GND}$; $1.62\text{ V} \leq V_{\text{LOGIC}} \leq 5.5\text{ V}$; all specifications T_{MIN} to T_{MAX} , unless otherwise noted.¹

Table 3.

Parameter ²	Min	Typ	Max	Unit	Test Conditions/Comments ³
Output Voltage Settling Time					
AD5686R		5	8	μs	¼ to ¾ scale settling to $\pm 2\text{ LSB}$
AD5685R		5	8	μs	¼ to ¾ scale settling to $\pm 2\text{ LSB}$
AD5684R		5	7	μs	¼ to ¾ scale settling to $\pm 2\text{ LSB}$
Slew Rate		0.8		$\text{V}/\mu\text{s}$	
Digital-to-Analog Glitch Impulse		0.5		$\text{nV}\text{-sec}$	1 LSB change around major carry
Digital Feedthrough		0.13		$\text{nV}\text{-sec}$	
Digital Crosstalk		0.1		$\text{nV}\text{-sec}$	
Analog Crosstalk		0.2		$\text{nV}\text{-sec}$	
DAC-to-DAC Crosstalk		0.3		$\text{nV}\text{-sec}$	
Total Harmonic Distortion ⁴		-80		dB	At ambient, $\text{BW} = 20\text{ kHz}$, $V_{DD} = 5\text{ V}$, $f_{\text{OUT}} = 1\text{ kHz}$
Output Noise Spectral Density		300		$\text{nV}/\sqrt{\text{Hz}}$	DAC code = midscale, 10 kHz ; gain = 2, internal reference enable
Output Noise		6		$\mu\text{V p-p}$	0.1 Hz to 10 Hz
SNR		90		dB	At ambient, $\text{BW} = 20\text{ kHz}$, $V_{DD} = 5\text{ V}$, $f_{\text{OUT}} = 1\text{ kHz}$
SFDR		83		dB	At ambient, $\text{BW} = 20\text{ kHz}$, $V_{DD} = 5\text{ V}$, $f_{\text{OUT}} = 1\text{ kHz}$
SINAD		80		dB	At ambient, $\text{BW} = 20\text{ kHz}$, $V_{DD} = 5\text{ V}$, $f_{\text{OUT}} = 1\text{ kHz}$

¹ Guaranteed by design and characterization, not production tested.

² See the Terminology section.

³ Temperature range is -40°C to $+105^\circ\text{C}$, typical at 25°C .

⁴ Digitally generated sine wave at 1 kHz .

TIMING CHARACTERISTICS

All input signals are specified with $t_R = t_F = 1 \text{ ns/V}$ (10% to 90% of V_{DD}) and timed from a voltage level of $(V_{IL} + V_{IH})/2$. See Figure 2. $V_{DD} = 2.7 \text{ V}$ to 5.5 V , $1.62 \text{ V} \leq V_{LOGIC} \leq 5.5 \text{ V}$; $V_{REFIN} = 2.5 \text{ V}$. All specifications T_{MIN} to T_{MAX} , unless otherwise noted.

Table 4.

Parameter ¹	Symbol	1.62 V ≤ V _{LOGIC} < 2.7 V		2.7 V ≤ V _{LOGIC} ≤ 5.5 V		Unit
		Min	Max	Min	Max	
SCLK Cycle Time	t ₁	20		20		ns
SCLK High Time	t ₂	10		10		ns
SCLK Low Time	t ₃	10		10		ns
SYNC to SCLK Falling Edge Setup Time	t ₄	15		10		ns
Data Setup Time	t ₅	5		5		ns
Data Hold Time	t ₆	5		5		ns
SCLK Falling Edge to SYNC Rising Edge	t ₇	10		10		ns
Minimum SYNC High Time	t ₈	20		20		ns
SYNC Rising Edge to SYNC Rising Edge (DAC Register Updates)	t ₉	870		830		ns
SYNC Falling Edge to SCLK Fall Ignore	t ₁₀	16		10		ns
LDAC Pulse Width Low	t ₁₁	15		15		ns
SYNC Rising Edge to LDAC Rising Edge	t ₁₂	20		20		ns
SYNC Rising Edge to LDAC Falling Edge	t ₁₃	30		30		ns
LDAC Falling Edge to SYNC Rising Edge	t ₁₄	840		800		ns
Minimum Pulse Width Low	t ₁₅	30		30		ns
Pulse Activation Time	t ₁₆	30		30		ns
Power-Up Time ²		4.5		4.5		μs

¹Guaranteed by design and characterization; not production tested.

²Time to exit power-down to normal mode of AD5686R/AD5685R/AD5684R operation, SYNC rising edge to 90% of DAC midscale value, with output unloaded.

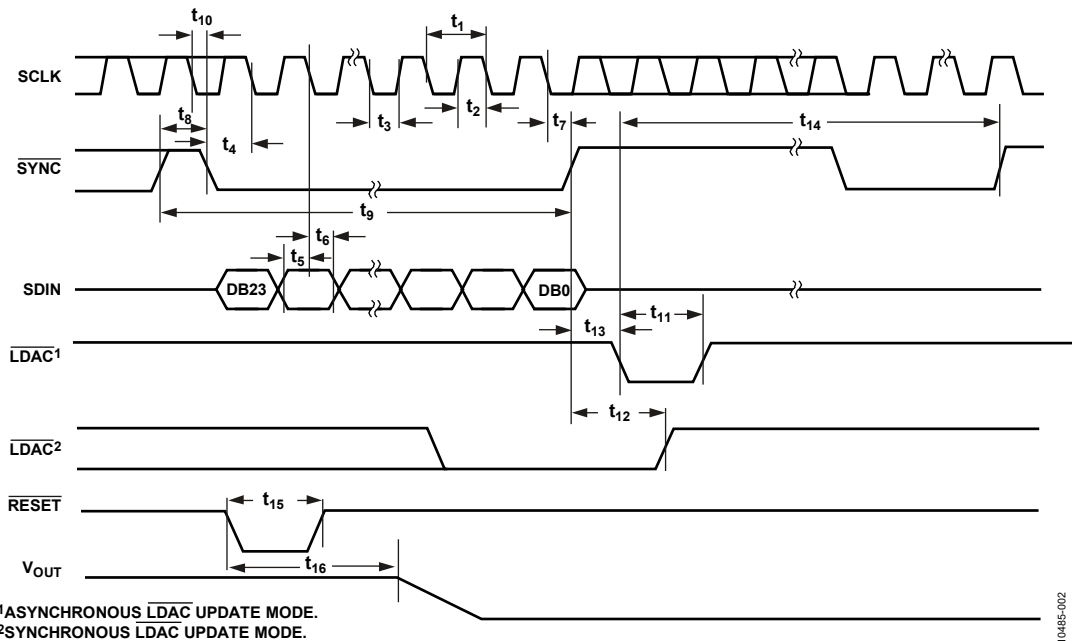

Figure 2. Serial Write Operation

10485-002

DAISY-CHAIN AND READBACK TIMING CHARACTERISTICS

All input signals are specified with $t_R = t_F = 1 \text{ ns/V}$ (10% to 90% of V_{DD}) and timed from a voltage level of $(V_{IL} + V_{IH})/2$. See Figure 4 and Figure 5. $V_{DD} = 2.7 \text{ V to } 5.5 \text{ V}$, $1.62 \text{ V} \leq V_{LOGIC} \leq 5.5 \text{ V}$; $V_{REF} = 2.5 \text{ V}$. All specifications T_{MIN} to T_{MAX} , unless otherwise noted. $V_{DD} = 2.7 \text{ V to } 5.5 \text{ V}$.

Table 5.

Parameter ¹	Symbol	1.62 V ≤ V _{LOGIC} < 2.7 V		2.7 V ≤ V _{LOGIC} ≤ 5.5 V		Unit
		Min	Max	Min	Max	
SCLK Cycle Time	t ₁	66		40		ns
SCLK High Time	t ₂	33		20		ns
SCLK Low Time	t ₃	33		20		ns
SYNC to SCLK Falling Edge	t ₄	33		20		ns
Data Setup Time	t ₅	5		5		ns
Data Hold Time	t ₆	5		5		ns
SCLK Falling Edge to SYNC Rising Edge	t ₇	15		10		ns
Minimum SYNC High Time	t ₈	60		30		ns
SDO Data Valid from SCLK Rising Edge	t ₉		45		30	ns
SYNC Rising Edge to SCLK Falling Edge	t ₁₀	15		10		ns
SYNC Rising Edge to SDO Disable	t ₁₁	60		60		ns

¹ Guaranteed by design and characterization; not production tested.

Circuit and Timing Diagrams

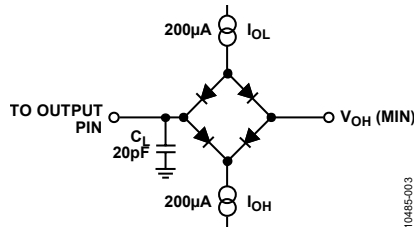

Figure 3. Load Circuit for Digital Output (SDO) Timing Specifications

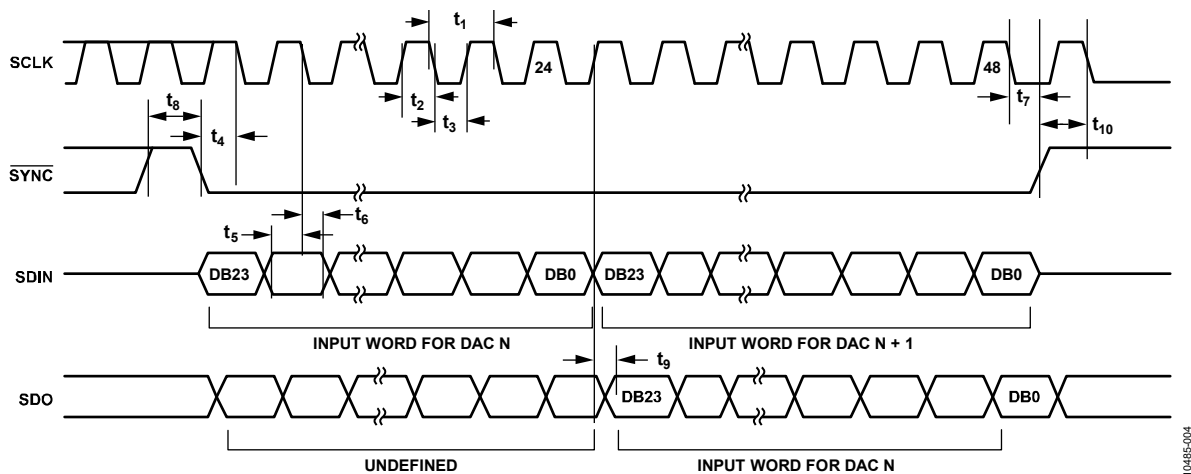

Figure 4. Daisy-Chain Timing Diagram

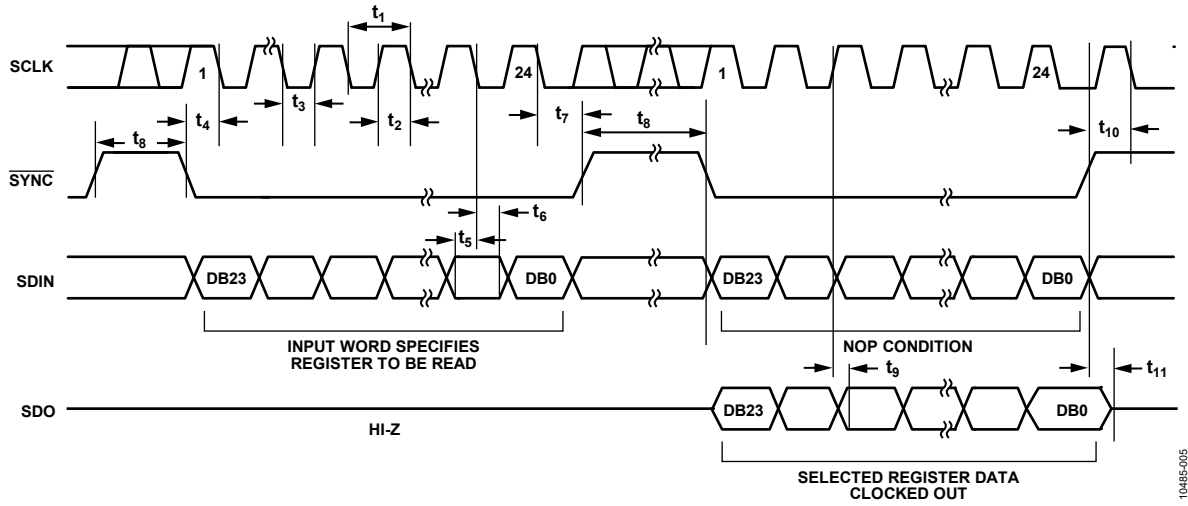

Figure 5. Readback Timing Diagram

10485-005

ABSOLUTE MAXIMUM RATINGS

$T_A = 25^\circ\text{C}$, unless otherwise noted.

Table 6.

Parameter	Rating
V_{DD} to GND	-0.3 V to +7 V
V_{LOGIC} to GND	-0.3 V to +7 V
V_{OUT} to GND	-0.3 V to $V_{DD} + 0.3$ V
V_{REF} to GND	-0.3 V to $V_{DD} + 0.3$ V
Digital Input Voltage to GND	-0.3 V to $V_{LOGIC} + 0.3$ V
Operating Temperature Range	-40°C to +105°C
Storage Temperature Range	-65°C to +150°C
Junction Temperature	125°C
16-Lead TSSOP, θ_{JA} Thermal Impedance, 0 Airflow (4-Layer Board)	112.6°C/W
16-Lead LFCSP, θ_{JA} Thermal Impedance, 0 Airflow (4-Layer Board)	70°C/W
Reflow Soldering Peak Temperature, Pb Free (J-STD-020)	260°C

Stresses at or above those listed under Absolute Maximum Ratings may cause permanent damage to the product. This is a stress rating only; functional operation of the product at these or any other conditions above those indicated in the operational section of this specification is not implied. Operation beyond the maximum operating conditions for extended periods may affect product reliability.

ESD CAUTION



ESD (electrostatic discharge) sensitive device. Charged devices and circuit boards can discharge without detection. Although this product features patented or proprietary protection circuitry, damage may occur on devices subjected to high energy ESD. Therefore, proper ESD precautions should be taken to avoid performance degradation or loss of functionality.

PIN CONFIGURATION AND FUNCTION DESCRIPTIONS

AD5686R/AD5685R/AD5684R

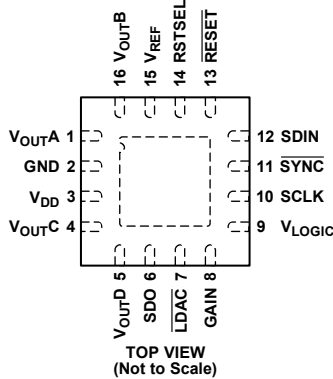

NOTES
1. THE EXPOSED PAD MUST BE TIED TO GND.

Figure 6. 16-Lead LFCSP Pin Configuration

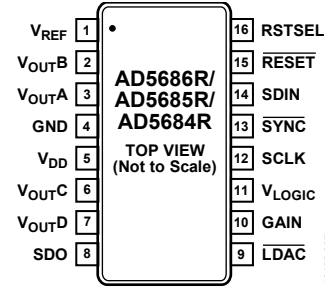

Figure 7. 16-Lead TSSOP Pin Configuration

Table 7. Pin Function Descriptions

Pin No.		Mnemonic	Description
LFCSP	TSSOP		
1	3	V _{OUTA}	Analog Output Voltage from DAC A. The output amplifier has rail-to-rail operation.
2	4	GND	Ground Reference Point for All Circuitry on the Part.
3	5	V _{DD}	Power Supply Input. These parts can be operated from 2.7 V to 5.5 V, and the supply should be decoupled with a 10 μF capacitor in parallel with a 0.1 μF capacitor to GND.
4	6	V _{OUTC}	Analog Output Voltage from DAC C. The output amplifier has rail-to-rail operation.
5	7	V _{OUTD}	Analog Output Voltage from DAC D. The output amplifier has rail-to-rail operation.
6	8	SDO	Serial Data Output. Can be used to daisy-chain a number of AD5686R/AD5685R/AD5684R devices together or can be used for readback. The serial data is transferred on the rising edge of SCLK and is valid on the falling edge of the clock.
7	9	LDAC	LDAC can be operated in two modes, asynchronously and synchronously. Pulsing this pin low allows any or all DAC registers to be updated if the input registers have new data. This allows all DAC outputs to simultaneously update. This pin can also be tied permanently low.
8	10	GAIN	Span Set Pin. When this pin is tied to GND, all four DAC outputs have a span from 0 V to V _{REF} . If this pin is tied to V _{LOGIC} , all four DACs output a span of 0 V to 2 × V _{REF} .
9	11	V _{LOGIC}	Digital Power Supply. Voltage ranges from 1.8 V to 5.5 V.
10	12	SCLK	Serial Clock Input. Data is clocked into the input shift register on the falling edge of the serial clock input. Data can be transferred at rates of up to 50 MHz.
11	13	SYNC	Active Low Control Input. This is the frame synchronization signal for the input data. When SYNC goes low, data is transferred in on the falling edges of the next 24 clocks.
12	14	SDIN	Serial Data Input. This device has a 24-bit input shift register. Data is clocked into the register on the falling edge of the serial clock input.
13	15	RESET	Asynchronous Reset Input. The RESET input is falling edge sensitive. When RESET is low, all LDAC pulses are ignored. When RESET is activated, the input register and the DAC register are updated with zero scale or midscale, depending on the state of the RSTSEL pin. If the pin is forced low at power-up, the POR circuit does not initialize correctly until the pin is released.
14	16	RSTSEL	Power-On Reset Pin. Tying this pin to GND powers up all four DACs to zero scale. Tying this pin to V _{LOGIC} powers up all four DACs to midscale.
15	1	V _{REF}	Reference Voltage. The AD5686R/AD5685R/AD5684R have a common reference pin. When using the internal reference, this is the reference output pin. When using an external reference, this is the reference input pin. The default for this pin is as a reference output.
16	2	V _{OUTB}	Analog Output Voltage from DAC B. The output amplifier has rail-to-rail operation.
17	N/A	EPAD	Exposed Pad. The exposed pad must be tied to GND.

TYPICAL PERFORMANCE CHARACTERISTICS

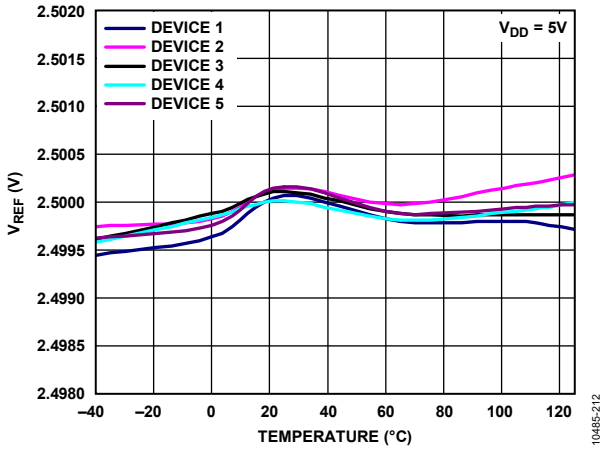

Figure 8. Internal Reference Voltage vs. Temperature (Grade B)

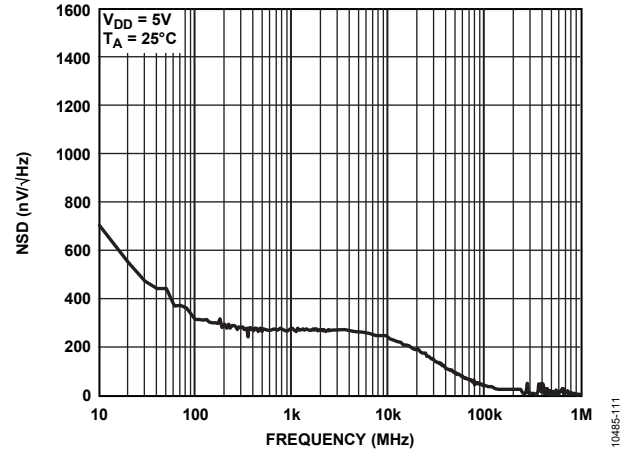

Figure 11. Internal Reference Noise Spectral Density vs. Frequency

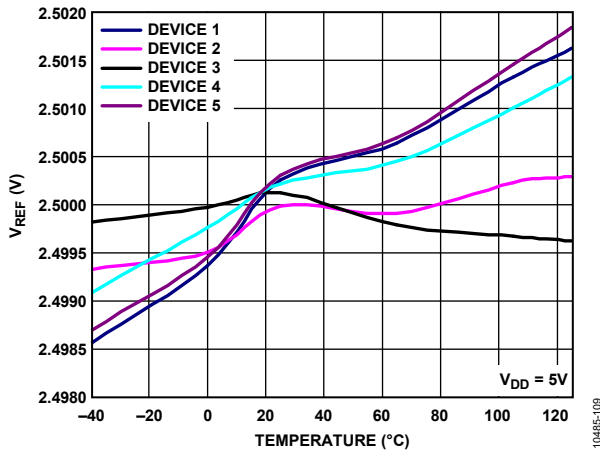

Figure 9. Internal Reference Voltage vs. Temperature (Grade A)

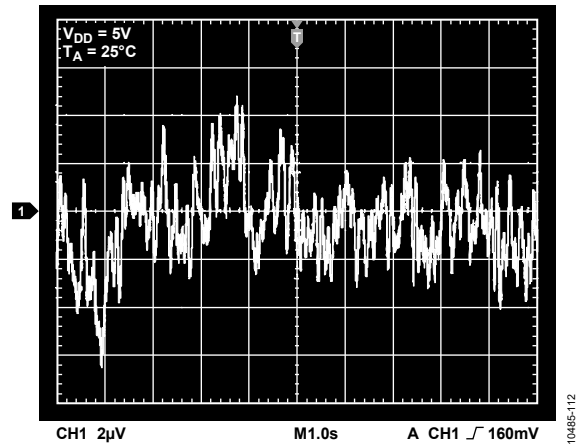

Figure 12. Internal Reference Noise, 0.1 Hz to 10 Hz

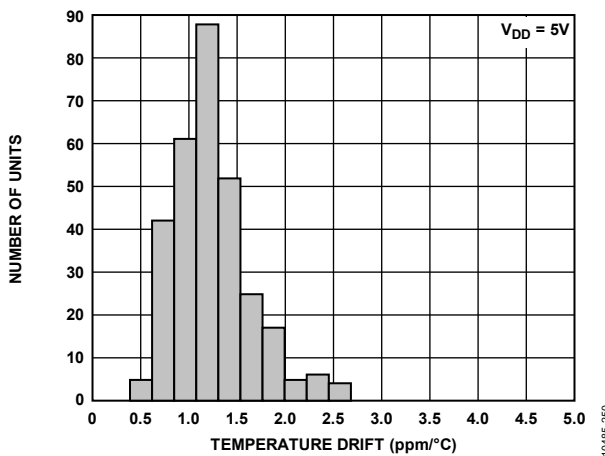

Figure 10. Reference Output Temperature Drift Histogram

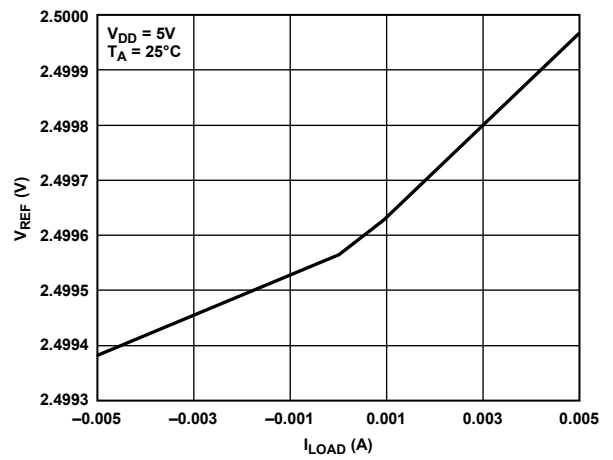

Figure 13. Internal Reference Voltage vs. Load Current

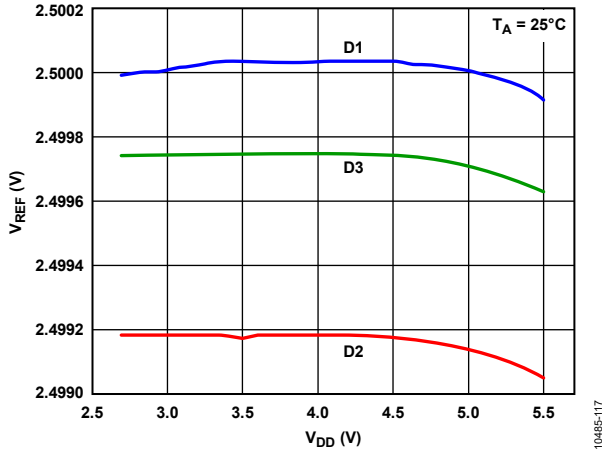

Figure 14. Internal Reference Voltage vs. Supply Voltage

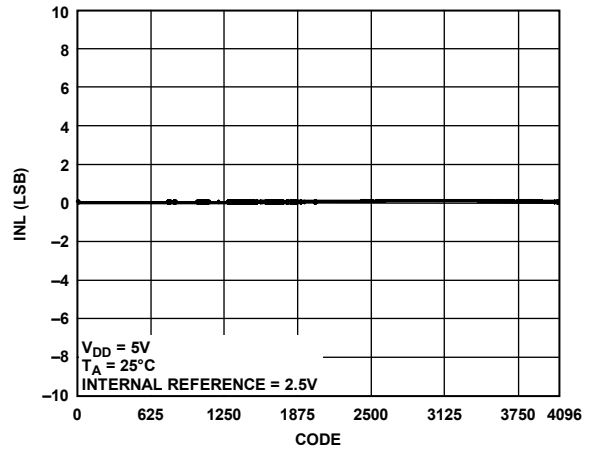

Figure 17. AD5684R INL

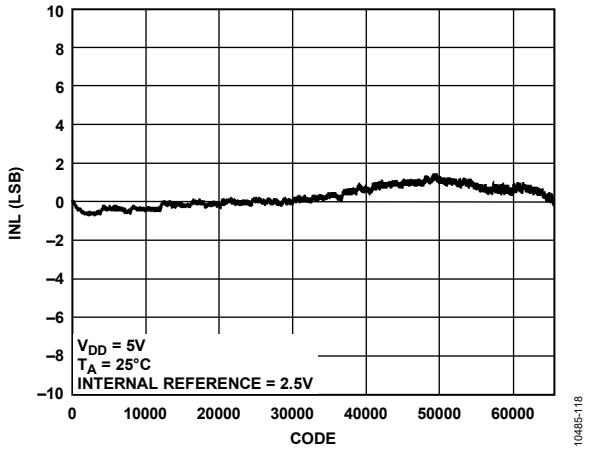

Figure 15. AD5686R INL

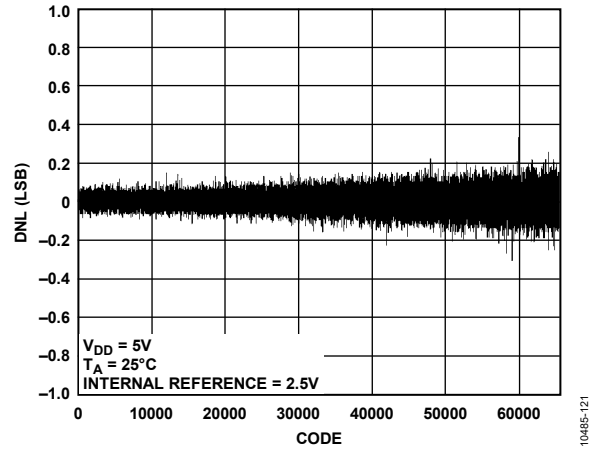

Figure 18. AD5686R DNL

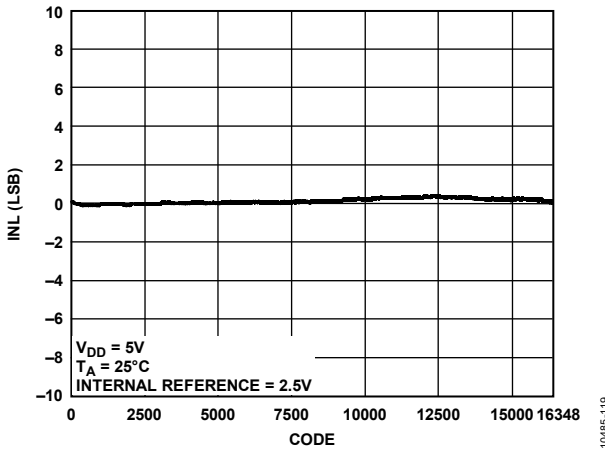

Figure 16. AD5685R INL

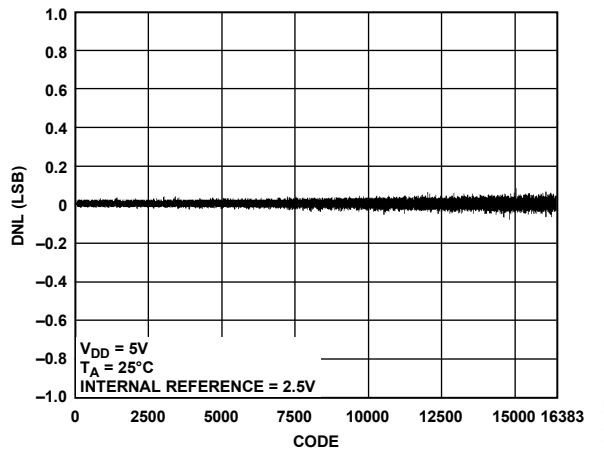

Figure 19. AD5685R DNL

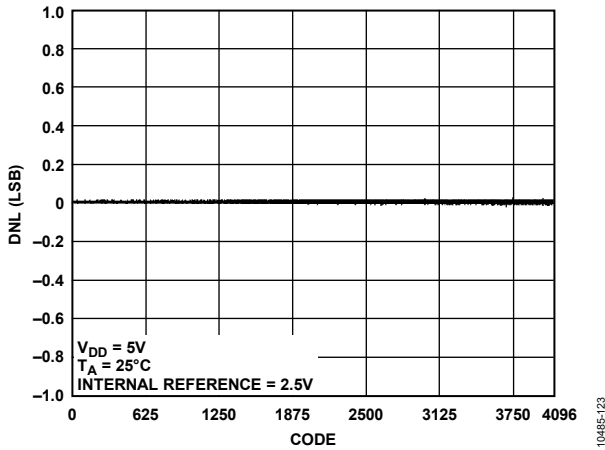

Figure 20. AD5684R DNL

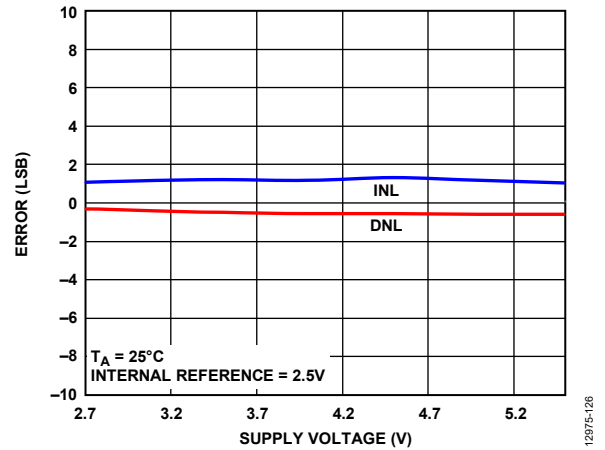

Figure 23. INL Error and DNL Error vs. Supply Voltage

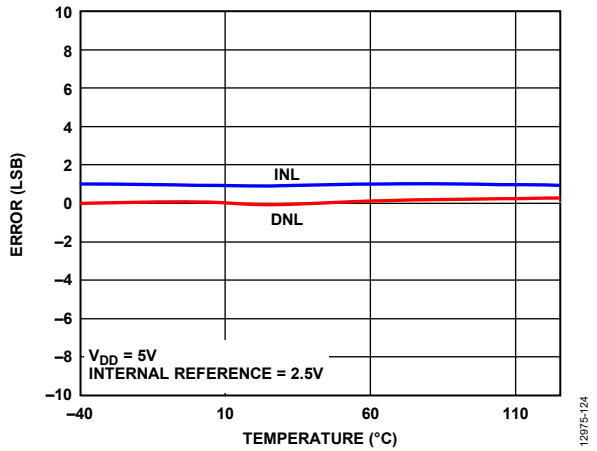

Figure 21. INL Error and DNL Error vs. Temperature

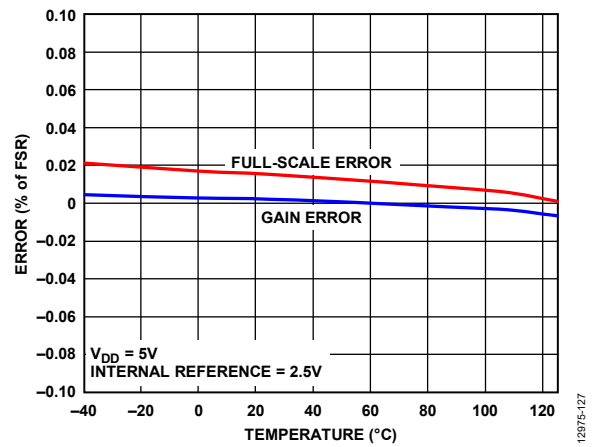

Figure 24. Gain Error and Full-Scale Error vs. Temperature

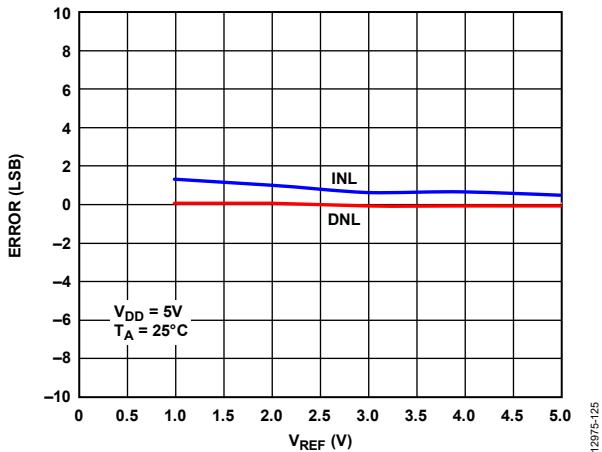

Figure 22. INL Error and DNL Error vs. V_{REF}

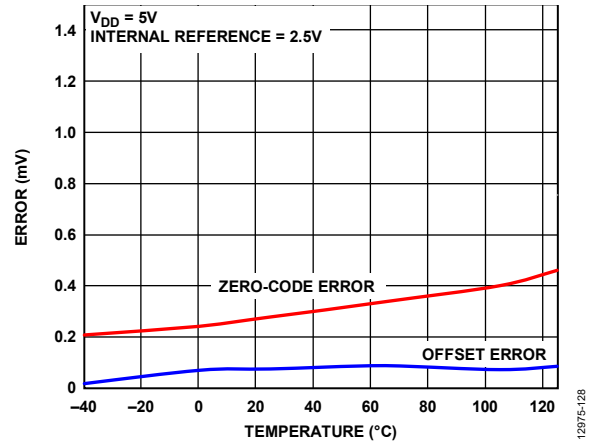

Figure 25. Zero-Code Error and Offset Error vs. Temperature

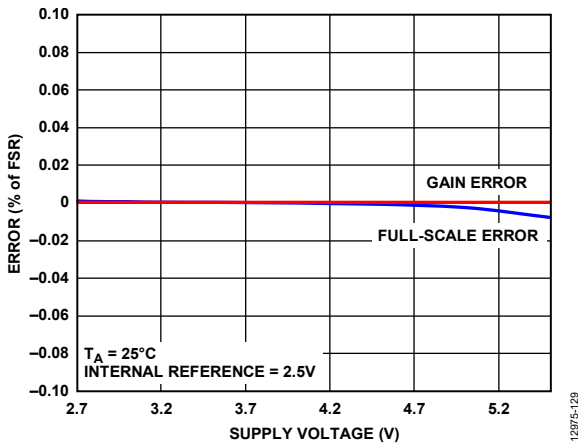

Figure 26. Gain Error and Full-Scale Error vs. Supply

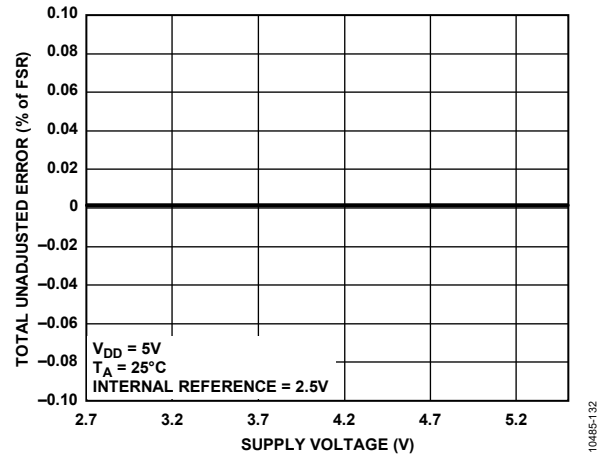

Figure 29. TUE vs. Supply, Gain = 1

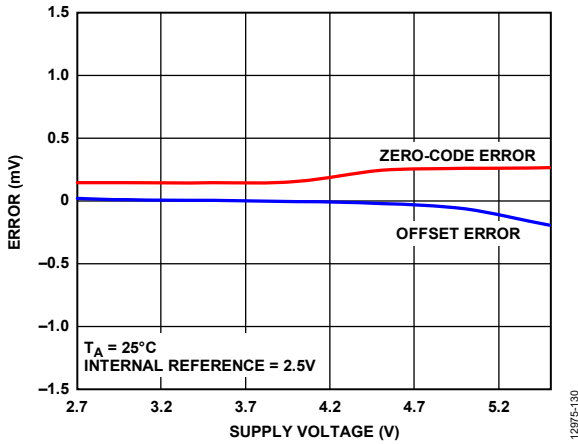

Figure 27. Zero-Code Error and Offset Error vs. Supply

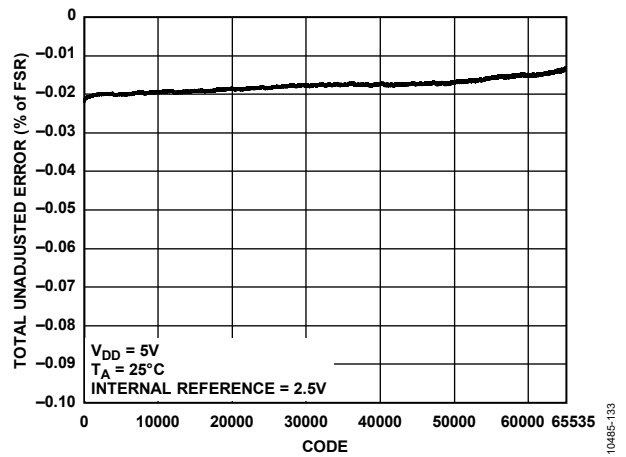

Figure 30. TUE vs. Code

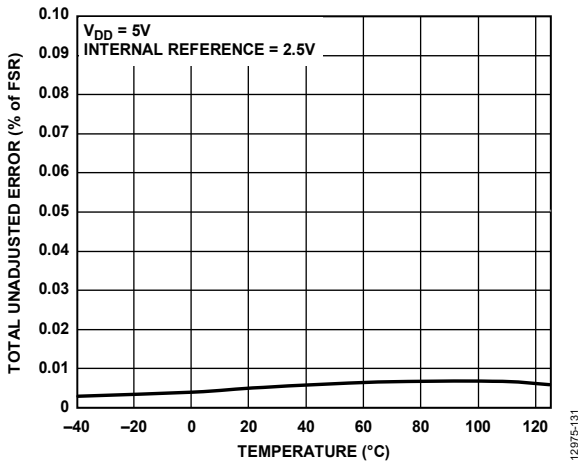

Figure 28. TUE vs. Temperature

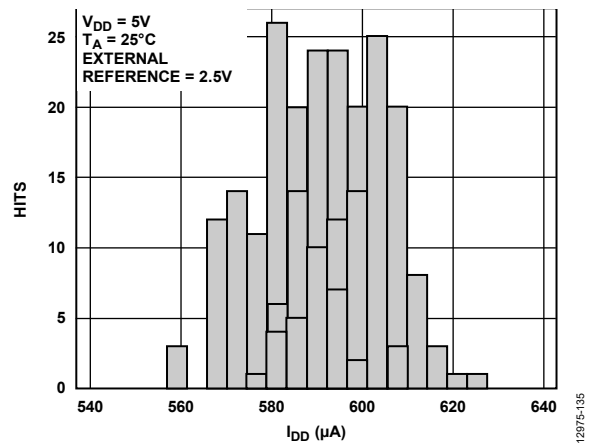

Figure 31. I_{DD} Histogram with External Reference, 5 V

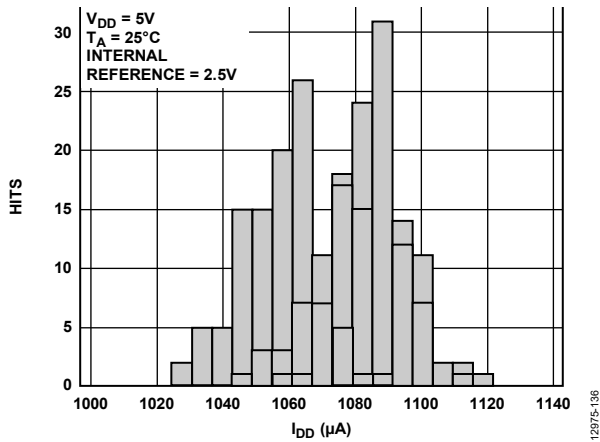

Figure 32. I_{DD} Histogram with Internal Reference, $V_{REFOUT} = 2.5\text{ V}$, Gain = 2

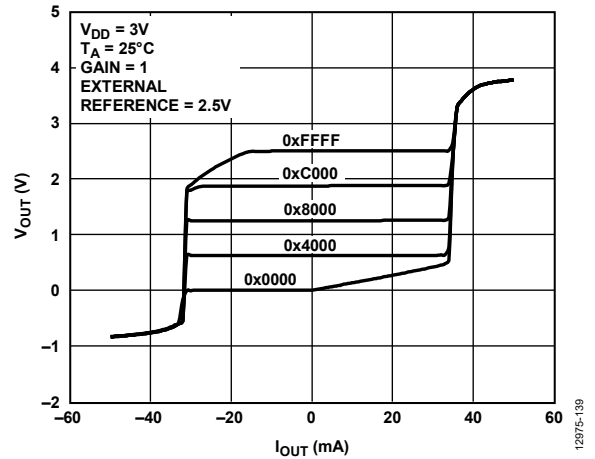

Figure 35. Source and Sink Capability at 3 V

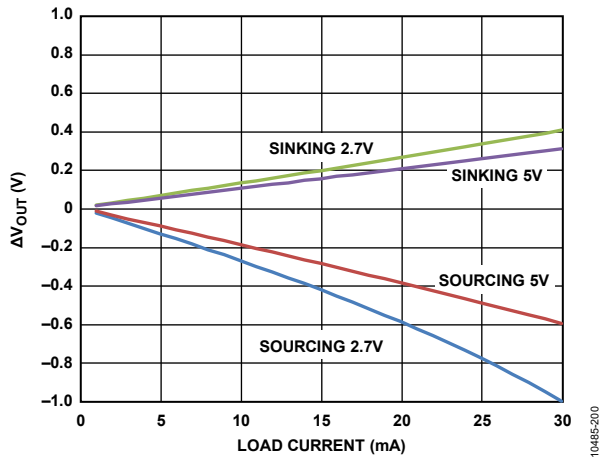

Figure 33. Headroom/Footroom vs. Load Current

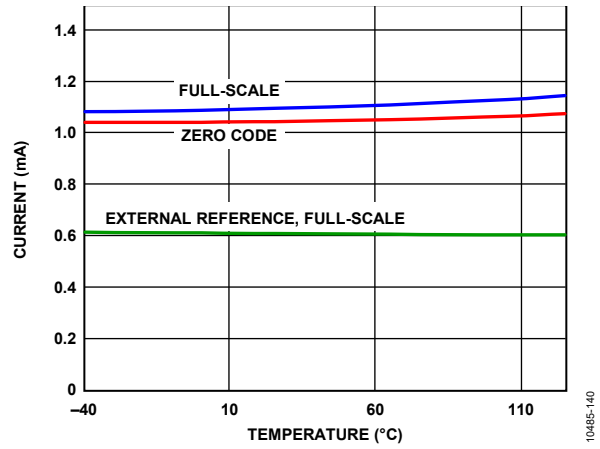

Figure 36. Supply Current vs. Temperature

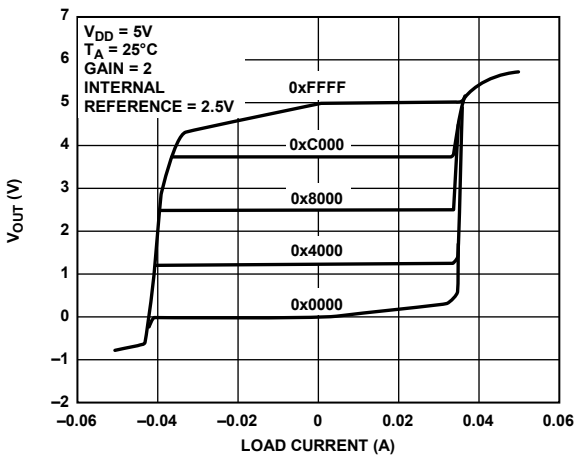

Figure 34. Source and Sink Capability at 5 V

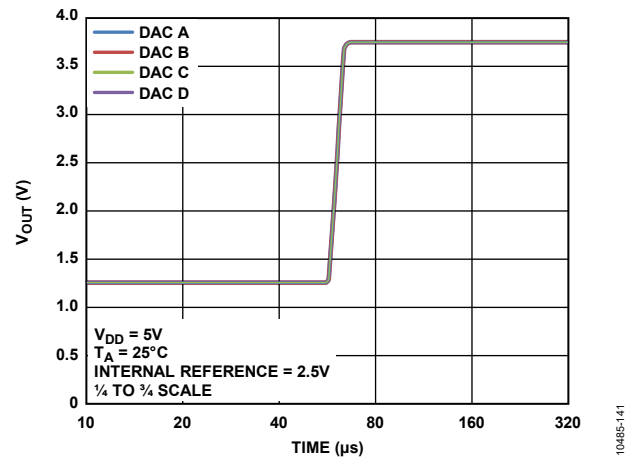

Figure 37. Settling Time, 5.25 V

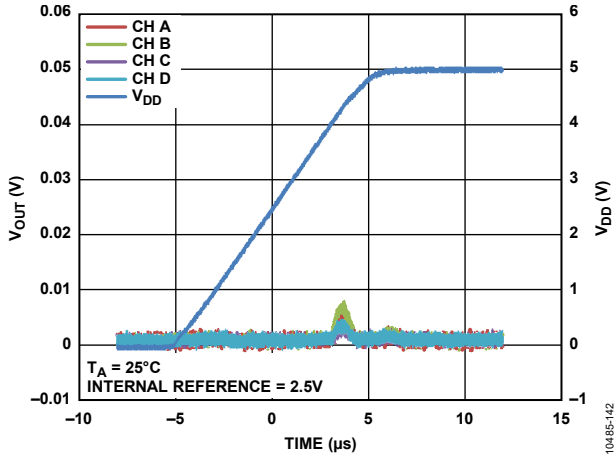

Figure 38. Power-On Reset to 0V

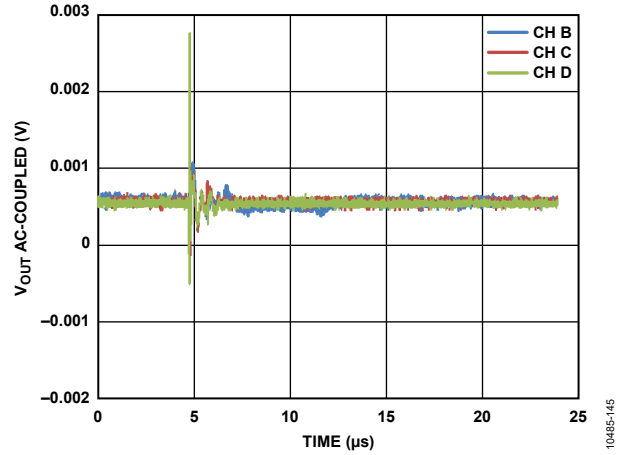

Figure 41. Analog Crosstalk, Channel A

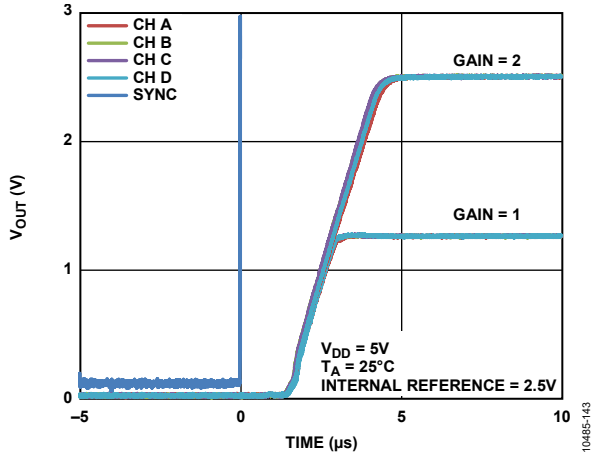

Figure 39. Exiting Power-Down to Midscale

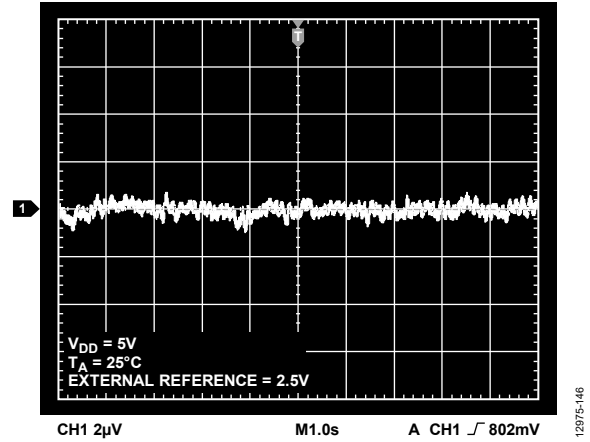

Figure 42. 0.1 Hz to 10 Hz Output Noise Plot, External Reference

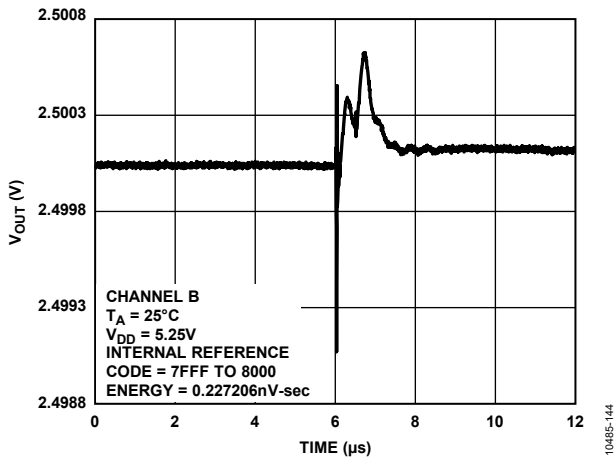

Figure 40. Digital-to-Analog Glitch Impulse

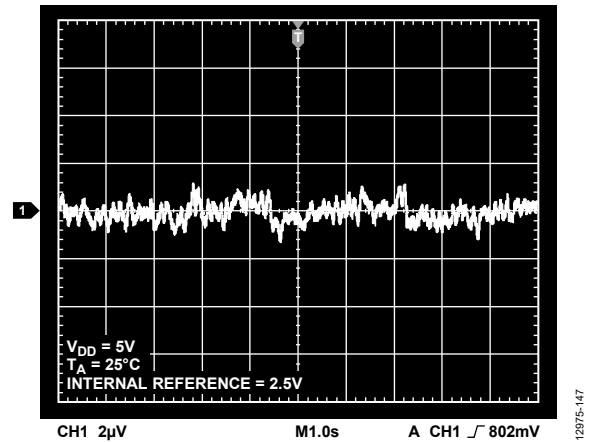

Figure 43. 0.1 Hz to 10 Hz Output Noise Plot, 2.5 V Internal Reference

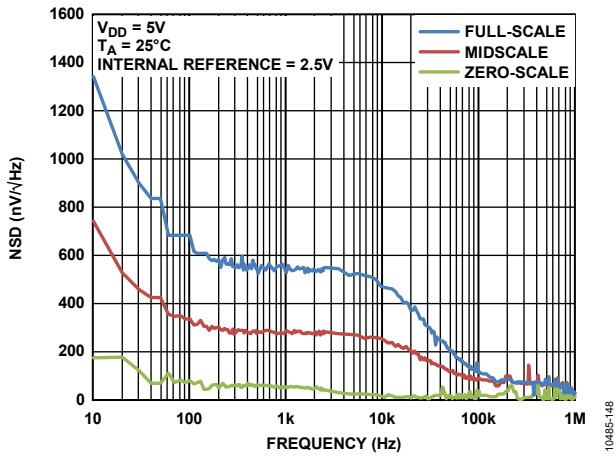

Figure 44. Noise Spectral Density

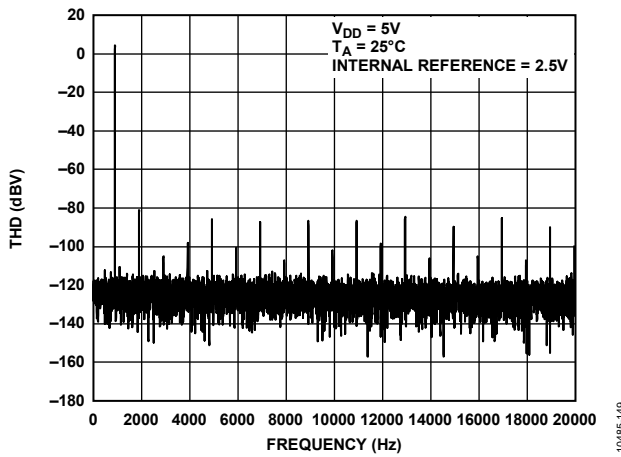

Figure 45. Total Harmonic Distortion at 1 kHz

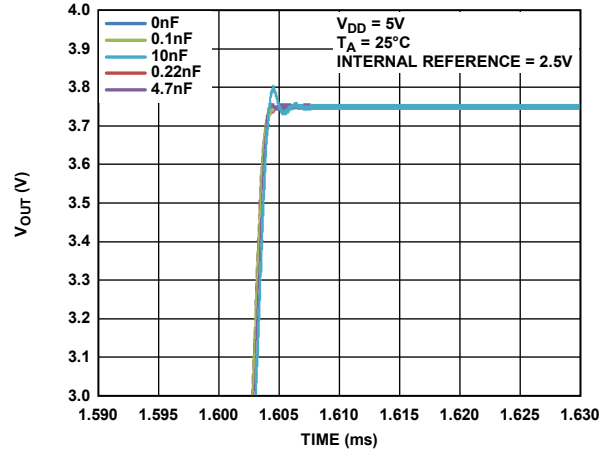

Figure 46. Settling Time vs. Capacitive Load

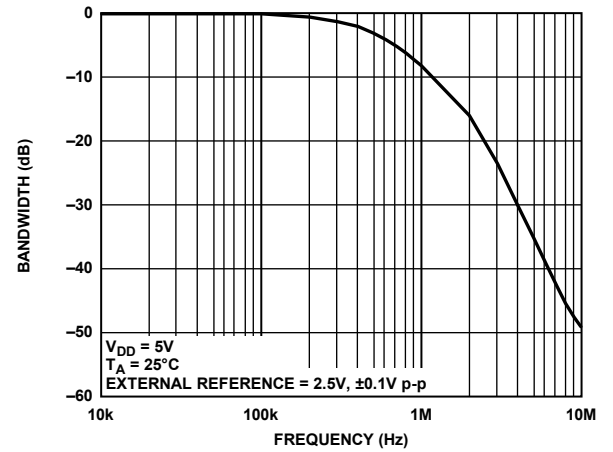

Figure 47. Multiplying Bandwidth, External Reference = 2.5 V, ± 0.1 V p-p, 10 kHz to 10 MHz

TERMINOLOGY

Relative Accuracy or Integral Nonlinearity (INL)

For the DAC, relative accuracy or integral nonlinearity is a measurement of the maximum deviation, in LSBs, from a straight line passing through the endpoints of the DAC transfer function. A typical INL vs. code plot is shown in Figure 15.

Differential Nonlinearity (DNL)

Differential nonlinearity is the difference between the measured change and the ideal 1 LSB change between any two adjacent codes. A specified differential nonlinearity of ± 1 LSB maximum ensures monotonicity. This DAC is guaranteed monotonic by design. A typical DNL vs. code plot can be seen in Figure 18.

Zero-Code Error

Zero-code error is a measurement of the output error when zero code (0x0000) is loaded to the DAC register. Ideally, the output should be 0 V. The zero-code error is always positive in the AD5686R because the output of the DAC cannot go below 0 V due to a combination of the offset errors in the DAC and the output amplifier. Zero-code error is expressed in mV. A plot of zero-code error vs. temperature can be seen in Figure 25.

Full-Scale Error

Full-scale error is a measurement of the output error when full-scale code (0xFFFF) is loaded to the DAC register. Ideally, the output should be $V_{DD} - 1$ LSB. Full-scale error is expressed in percent of full-scale range (% of FSR). A plot of full-scale error vs. temperature can be seen in Figure 24.

Gain Error

This is a measure of the span error of the DAC. It is the deviation in slope of the DAC transfer characteristic from the ideal expressed as % of FSR.

Offset Error Drift

This is a measurement of the change in offset error with a change in temperature. It is expressed in $\mu\text{V}/^\circ\text{C}$.

Gain Temperature Coefficient

This is a measurement of the change in gain error with changes in temperature. It is expressed in ppm of FSR/ $^\circ\text{C}$.

Offset Error

Offset error is a measure of the difference between V_{OUT} (actual) and V_{OUT} (ideal) expressed in mV in the linear region of the transfer function. Offset error is measured on the AD5686R with Code 512 loaded in the DAC register. It can be negative or positive.

DC Power Supply Rejection Ratio (PSRR)

This indicates how the output of the DAC is affected by changes in the supply voltage. PSRR is the ratio of the change in V_{OUT} to a change in V_{DD} for full-scale output of the DAC. It is measured in mV/V. V_{REF} is held at 2 V, and V_{DD} is varied by $\pm 10\%$.

Output Voltage Settling Time

This is the amount of time it takes for the output of a DAC to settle to a specified level for a $\frac{1}{4}$ to $\frac{3}{4}$ full-scale input change and is measured from the rising edge of SYNC.

Digital-to-Analog Glitch Impulse

Digital-to-analog glitch impulse is the impulse injected into the analog output when the input code in the DAC register changes state. It is normally specified as the area of the glitch in nV-sec, and is measured when the digital input code is changed by 1 LSB at the major carry transition (0x7FFF to 0x8000) (see Figure 40).

Digital Feedthrough

Digital feedthrough is a measure of the impulse injected into the analog output of the DAC from the digital inputs of the DAC, but is measured when the DAC output is not updated. It is specified in nV-sec, and measured with a full-scale code change on the data bus, that is, from all 0s to all 1s and vice versa.

Reference Feedthrough

Reference feedthrough is the ratio of the amplitude of the signal at the DAC output to the reference input when the DAC output is not being updated. It is expressed in dB.

Noise Spectral Density

This is a measurement of the internally generated random noise. Random noise is characterized as a spectral density (nV/ $\sqrt{\text{Hz}}$). It is measured by loading the DAC to midscale and measuring noise at the output. It is measured in nV/ $\sqrt{\text{Hz}}$. A plot of noise spectral density is shown in Figure 44.

DC Crosstalk

DC crosstalk is the dc change in the output level of one DAC in response to a change in the output of another DAC. It is measured with a full-scale output change on one DAC (or soft power-down and power-up) while monitoring another DAC kept at midscale. It is expressed in μV .

DC crosstalk due to load current change is a measure of the impact that a change in load current on one DAC has to another DAC kept at midscale. It is expressed in $\mu\text{V}/\text{mA}$.

Digital Crosstalk

This is the glitch impulse transferred to the output of one DAC at midscale in response to a full-scale code change (all 0s to all 1s and vice versa) in the input register of another DAC. It is measured in standalone mode and is expressed in nV-sec.

Analog Crosstalk

This is the glitch impulse transferred to the output of one DAC due to a change in the output of another DAC. It is measured by loading one of the input registers with a full-scale code change (all 0s to all 1s and vice versa). Then execute a software LDAC and monitor the output of the DAC whose digital code was not changed. The area of the glitch is expressed in nV-sec.

DAC-to-DAC Crosstalk

This is the glitch impulse transferred to the output of one DAC due to a digital code change and subsequent analog output change of another DAC. It is measured by loading the attack channel with a full-scale code change (all 0s to all 1s and vice versa), using the write to and update commands while monitoring the output of the victim channel that is at midscale. The energy of the glitch is expressed in nV-sec.

Multiplying Bandwidth

The amplifiers within the DAC have a finite bandwidth. The multiplying bandwidth is a measure of this. A sine wave on the reference (with full-scale code loaded to the DAC) appears on the output. The multiplying bandwidth is the frequency at which the output amplitude falls to 3 dB below the input.

Total Harmonic Distortion (THD)

This is the difference between an ideal sine wave and its attenuated version using the DAC. The sine wave is used as the reference for the DAC, and the THD is a measurement of the harmonics present on the DAC output. It is measured in dB.

Voltage Reference TC

Voltage reference TC is a measure of the change in the reference output voltage with a change in temperature. The reference TC is calculated using the box method, which defines the TC as the maximum change in the reference output over a given temperature range expressed in ppm/°C, as follows;

$$TC = \left[\frac{V_{REFmax} - V_{REFmin}}{V_{REFnom} \times TempRange} \right] \times 10^6$$

where:

V_{REFmax} is the maximum reference output measured over the total temperature range.

V_{REFmin} is the minimum reference output measured over the total temperature range.

V_{REFnom} is the nominal reference output voltage, 2.5 V.

$TempRange$ is the specified temperature range of -40°C to $+105^{\circ}\text{C}$.

THEORY OF OPERATION

DIGITAL-TO-ANALOG CONVERTER

The AD5686R/AD5685R/AD5684R are quad 16-/14-/12-bit, serial input, voltage output DACs with an internal reference. The parts operate from supply voltages of 2.7 V to 5.5 V. Data is written to the AD5686R/AD5685R/AD5684R in a 24-bit word format via a 3-wire serial interface. The AD5686R/AD5685R/AD5684R incorporate a power-on reset circuit to ensure that the DAC output powers up to a known output state. The devices also have a software power-down mode that reduces the typical current consumption to typically 4 μ A.

TRANSFER FUNCTION

The internal reference is on by default. To use an external reference, only a nonreference option is available. Because the input coding to the DAC is straight binary, the ideal output voltage when using an external reference is given by

$$V_{OUT} = V_{REF} \times Gain \left[\frac{D}{2^N} \right]$$

where:

D is the decimal equivalent of the binary code that is loaded to the DAC register as follows:

- 0 to 4,095 for the 12-bit device.
- 0 to 16,383 for the 14-bit device.
- 0 to 65,535 for the 16-bit device.

N is the DAC resolution.

$Gain$ is the gain of the output amplifier and is set to 1 by default. This can be set to $\times 1$ or $\times 2$ using the gain select pin. When this pin is tied to GND, all four DAC outputs have a span from 0 V to V_{REF} . If this pin is tied to V_{DD} , all four DACs output a span of 0 V to $2 \times V_{REF}$.

DAC ARCHITECTURE

The DAC architecture consists of a string DAC followed by an output amplifier. Figure 48 shows a block diagram of the DAC architecture.

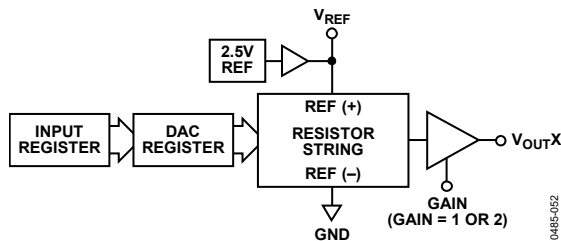

Figure 48. Single DAC Channel Architecture Block Diagram

The resistor string structure is shown in Figure 49. It is a string of resistors, each of Value R . The code loaded to the DAC register determines the node on the string where the voltage is to be tapped off and fed into the output amplifier. The voltage is tapped off by closing one of the switches connecting the string to the amplifier. Because it is a string of resistors, it is guaranteed monotonic.

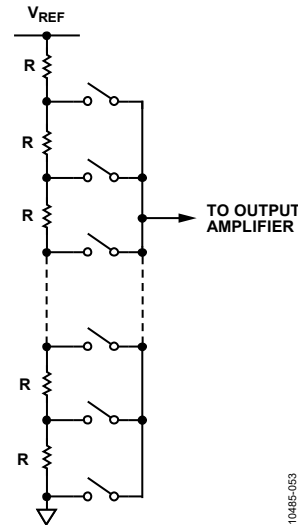

Figure 49. Resistor String Structure

Internal Reference

The AD5686R/AD5685R/AD5684R on-chip reference is on at power-up but can be disabled via a write to a control register. See the Internal Reference Setup section for details.

The AD5686R/AD5685R/AD5684R have a 2.5 V, 2 ppm/ $^{\circ}$ C reference, giving a full-scale output of 2.5 V or 5 V, depending on the state of the GAIN pin. The internal reference associated with the device is available at the V_{REF} pin. This buffered reference is capable of driving external loads of up to 10 mA.

Output Amplifiers

The output buffer amplifier can generate rail-to-rail voltages on its output, which gives an output range of 0 V to V_{DD} . The actual range depends on the value of V_{REF} , the GAIN pin, offset error, and gain error. The GAIN pin selects the gain of the output.

- If this pin is tied to GND, all four outputs have a gain of 1 and the output range is 0 V to V_{REF} .
- If this pin is tied to V_{LOGIC} , all four outputs have a gain of 2 and the output range is 0 V to $2 \times V_{REF}$.

These amplifiers are capable of driving a load of 1 k Ω in parallel with 2 nF to GND. The slew rate is 0.8 V/ μ s with a $\frac{1}{4}$ to $\frac{3}{4}$ scale settling time of 5 μ s.

SERIAL INTERFACE

The AD5686R/AD5685R/AD5684R have a 3-wire serial interface (SYNC, SCLK, and SDIN) that is compatible with SPI, QSPI, and MICROWIRE interface standards as well as most DSPs. See Figure 2 for a timing diagram of a typical write sequence. The AD5686R/AD5685R/AD5684R contain an SDO pin to allow the user to daisy-chain multiple devices together (see the Daisy-Chain Operation section) or for readback.

Input Shift Register

The input shift register of the AD5686R/AD5685R/AD5684R is 24 bits wide. Data is loaded MSB first (DB23) and the first four bits are the command bits, C3 to C0 (see Table 8), followed by the 4-bit DAC address bits, DAC A, DAC B, DAC C, DAC D (see Table 9), and finally the bit data-word.

The data-word comprises 16-bit, 14-bit, or 12-bit input code, followed by zero, two or four don't care bits for the AD5686R, AD5685R, and AD5684R, respectively (see Figure 50, Figure 51, and Figure 52). These data bits are transferred to the input register on the 24 falling edges of SCLK and are updated on the rising edge of SYNC.

Commands can be executed on individual DAC channels, combined DAC channels, or on all DACs, depending on the address bits selected.

Table 8. Command Definitions

Command				Description
C3	C2	C1	C0	
0	0	0	0	No operation
0	0	0	1	Write to Input Register n (dependent on $\overline{\text{LDAC}}$)
0	0	1	0	Update DAC Register n with contents of Input Register n
0	0	1	1	Write to and update DAC Channel n
0	1	0	0	Power down/power up DAC
0	1	0	1	Hardware $\overline{\text{LDAC}}$ mask register
0	1	1	0	Software reset (power-on reset)
0	1	1	1	Internal reference setup register
1	0	0	0	Set up DCEN register (daisy-chain enable)
1	0	0	1	Set up readback register (readback enable)
1	0	1	0	Reserved
...	Reserved
1	1	1	1	No operation, daisy-chain mode

Table 9. Address Commands

Address (n)				Selected DAC Channel ¹
DAC D	DAC C	DAC B	DAC A	
0	0	0	1	DAC A
0	0	1	0	DAC B
0	1	0	0	DAC C
1	0	0	0	DAC D
0	0	1	1	DAC A and DAC B
1	1	1	1	All DACs

¹ Any combination of DAC channels can be selected using the address bits.

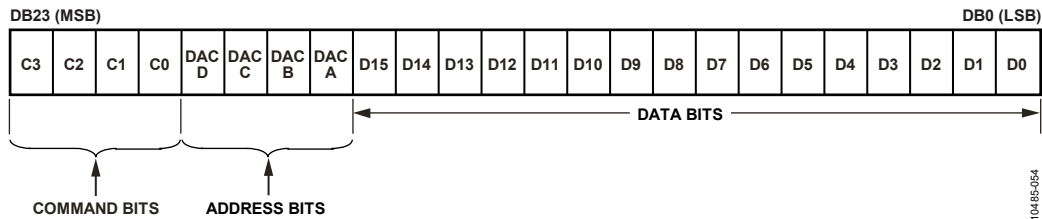

Figure 50. AD5686R Input Shift Register Content

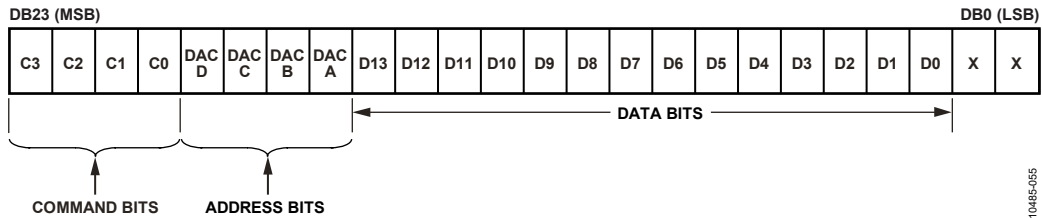

Figure 51. AD5685R Input Shift Register Content

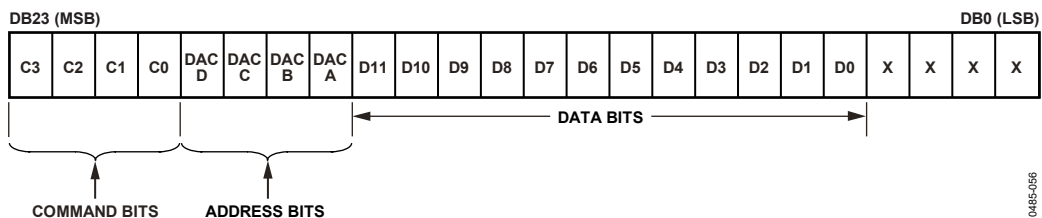

Figure 52. AD5684R Input Shift Register Content

STANDALONE OPERATION

The write sequence begins by bringing the $\overline{\text{SYNC}}$ line low. Data from the SDIN line is clocked into the 24-bit input shift register on the falling edge of SCLK. After the last of 24 data bits is clocked in, $\overline{\text{SYNC}}$ should be brought high. The programmed function is then executed, that is, an $\overline{\text{LDAC}}$ -dependent change in DAC register contents and/or a change in the mode of operation. If $\overline{\text{SYNC}}$ is taken high at a clock before the 24th clock, it is considered a valid frame and invalid data may be loaded to the DAC. $\overline{\text{SYNC}}$ must be brought high for a minimum of 20 ns (single channel, see t_s in Figure 2) before the next write sequence so that a falling edge of $\overline{\text{SYNC}}$ can initiate the next write sequence. $\overline{\text{SYNC}}$ should be idled at rails between write sequences for even lower power operation of the part. The $\overline{\text{SYNC}}$ line is kept low for 24 falling edges of SCLK, and the DAC is updated on the rising edge of $\overline{\text{SYNC}}$.

When the data has been transferred into the input register of the addressed DAC, all DAC registers and outputs can be updated by taking $\overline{\text{LDAC}}$ low while the $\overline{\text{SYNC}}$ line is high.

WRITE AND UPDATE COMMANDS

Write to Input Register n (Dependent on $\overline{\text{LDAC}}$)

Command 0001 allows the user to write to each DAC's dedicated input register individually. When $\overline{\text{LDAC}}$ is low, the input register is transparent (if not controlled by the $\overline{\text{LDAC}}$ mask register).

Update DAC Register n with Contents of Input Register n

Command 0010 loads the DAC registers/outputs with the contents of the input registers selected and updates the DAC outputs directly.

Write to and Update DAC Channel n (Independent of $\overline{\text{LDAC}}$)

Command 0011 allows the user to write to the DAC registers and update the DAC outputs directly.

DAISY-CHAIN OPERATION

For systems that contain several DACs, the SDO pin can be used to daisy-chain several devices together and is enabled through a software executable daisy-chain enable (DCEN) command. Command 1000 is reserved for this DCEN function (see Table 8). The daisy-chain mode is enabled by setting Bit DB0 in the DCEN register. The default setting is standalone mode, where DB0 = 0. Table 10 shows how the state of the bit corresponds to the mode of operation of the device.

Table 10. Daisy-Chain Enable (DCEN) Register

DB0	Description
0	Standalone mode (default)
1	DCEN mode

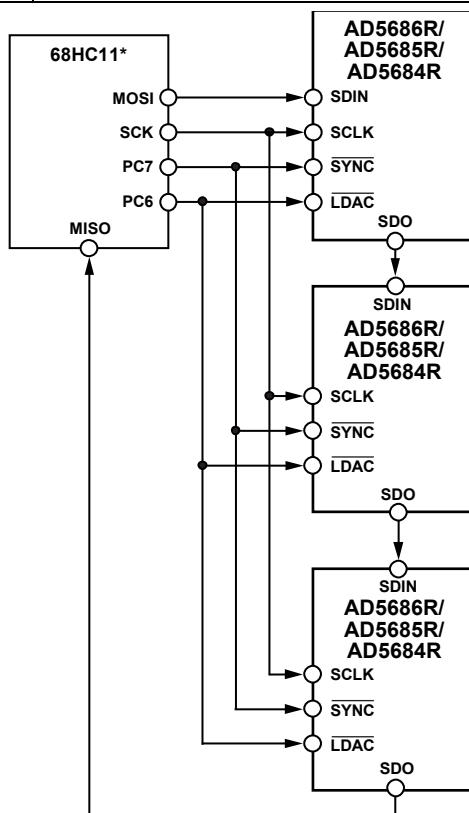

*ADDITIONAL PINS OMITTED FOR CLARITY.

Figure 53. Daisy-Chaining the AD5686R/AD5685R/AD5684R

The SCLK pin is continuously applied to the input shift register when SYNC is low. If more than 24 clock pulses are applied, the data ripples out of the input shift register and appears on the SDO line. This data is clocked out on the rising edge of SCLK and is valid on the falling edge. By connecting this line to the SDIN input on the next DAC in the chain, a daisy-chain interface is constructed. Each DAC in the system requires 24 clock pulses. Therefore, the total number of clock cycles must equal $24 \times N$, where N is the total number of devices that are updated. If SYNC is taken high at a clock that is not a multiple of 24, it is considered a valid frame and invalid data may be loaded to the

DAC. When the serial transfer to all devices is complete, SYNC is taken high. This latches the input data in each device in the daisy chain and prevents any further data from being clocked into the input shift register. The serial clock can be continuous or a gated clock. A continuous SCLK source can be used only if SYNC can be held low for the correct number of clock cycles. In gated clock mode, a burst clock containing the exact number of clock cycles must be used, and SYNC must be taken high after the final clock to latch the data.

READBACK OPERATION

Readback mode is invoked through a software executable readback command. If the SDO output is disabled via the daisy-chain mode disable bit in the control register, it is automatically enabled for the duration of the read operation, after which it is disabled again. Command 1001 is reserved for the readback function. This command, in association with selecting one of address bits, DAC A to DAC D, selects the register to read. Note that only one DAC register can be selected during readback. The remaining three address bits must be set to Logic 0. The remaining data bits in the write sequence are don't care bits. If more than one or no bits are selected, DAC Channel A is read back by default. During the next SPI write, the data appearing on the SDO output contains the data from the previously addressed register.

For example, to read back the DAC register for Channel A, the following sequence should be implemented:

1. Write 0x900000 to the AD5686R/AD5685R/AD5684R input register. This configures the part for read mode with the DAC register of Channel A selected. Note that all data bits, DB15 to DB0, are don't care bits.
2. Follow this with a second write, a NOP condition, 0x000000 (0xF00000 in daisy-chain mode). During this write, the data from the register is clocked out on the SDO line.

For the 16-bit AD5686R, DB23 to DB20 contain undefined data, and the last 16 bits contain the DB19 to DB4 DAC register contents.

For the 14-bit AD5685R, DB23 to DB20 and DB1 to DB0 contain undefined data, and the 14-bit DAC register contents are contained in DB19 to DB2.

For the 12-bit AD5684R, DB23 to DB20 and DB3 to DB0 contain undefined data, and the 12-bit DAC register contents are contained in DB19 to DB4.

POWER-DOWN OPERATION

The AD5686R/AD5685R/AD5684R contain three separate power-down modes. Command 0100 is designated for the power-down function (see Table 8). These power-down modes are software-programmable by setting eight bits, Bit DB7 to Bit DB0, in the input shift register. There are two bits associated with each DAC channel. Table 11 shows how the state of the two bits corresponds to the mode of operation of the device.

Table 11. Modes of Operation

Operating Mode	PDx1	PDx0
Normal Operation	0	0
Power-Down Modes		
1 k Ω to GND	0	1
100 k Ω to GND	1	0
Three-State	1	1

Any or all DACs (DAC A to DAC D) can be powered down to the selected mode by setting the corresponding bits. See Table 12 for the contents of the input shift register during the power-down/power-up operation.

When both Bit PDx1 and Bit PDx0 (where x is the channel selected) in the input shift register are set to 0, the parts work normally with its normal power consumption of 4 mA at 5 V. However, for the three power-down modes, the supply current falls to 4 μ A at 5 V. Not only does the supply current fall, but

the output stage is also internally switched from the output of the amplifier to a resistor network of known values. This has the advantage that the output impedance of the part is known while the part is in power-down mode. There are three different power-down options. The output is connected internally to GND through either a 1 k Ω or a 100 k Ω resistor, or it is left open-circuited (three-state). The output stage is illustrated in Figure 54.

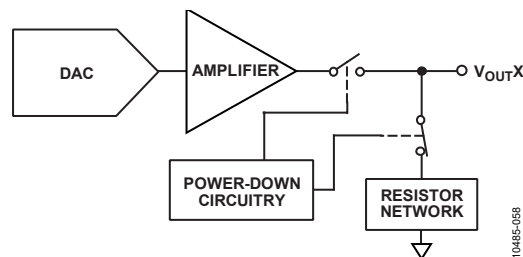

Figure 54. Output Stage During Power-Down

The bias generator, output amplifier, resistor string, and other associated linear circuitry are shut down when the power-down mode is activated. However, the contents of the DAC register are unaffected when in power-down. The DAC register can be updated while the device is in power-down mode. The time required to exit power-down is typically 4.5 μ s for $V_{DD} = 5$ V.

To reduce the current consumption further, the on-chip reference can be powered off. See the Internal Reference Setup section.

Table 12. 24-Bit Input Shift Register Contents of Power-Down/Power-Up Operation¹

DB23	DB22	DB21	DB20	DB19 to DB16	DB15 to DB8	DB7	DB6	DB5	DB4	DB3	DB2	DB1	DB0 (LSB)
0	1	0	0	X	X	PDD1	PDD0	PDC1	PDC0	PDB1	PDB0	PDA1	PDA0
Command bits (C3 to C0)				Address bits Don't care		Power-Down Select DAC D		Power-Down Select DAC C		Power-Down Select DAC B		Power-Down Select DAC A	

¹ X means don't care.

LOAD DAC (HARDWARE $\overline{\text{LDAC}}$ PIN)

The AD5686R/AD5685R/AD5684R DACs have double buffered interfaces consisting of two banks of registers: input registers and DAC registers. The user can write to any combination of the input registers. Updates to the DAC register are controlled by the $\overline{\text{LDAC}}$ pin.

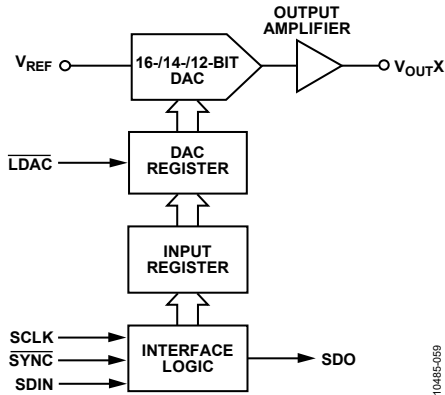

Figure 55. Simplified Diagram of Input Loading Circuitry for a Single DAC

Instantaneous DAC Updating ($\overline{\text{LDAC}}$ Held Low)

$\overline{\text{LDAC}}$ is held low while data is clocked into the input register using Command 0001. Both the addressed input register and the DAC register are updated on the rising edge of SYNC and the output begins to change (see Table 14).

Deferred DAC Updating ($\overline{\text{LDAC}}$ is Pulsed Low)

$\overline{\text{LDAC}}$ is held high while data is clocked into the input register using Command 0001. All DAC outputs are asynchronously updated by taking $\overline{\text{LDAC}}$ low after SYNC has been taken high. The update now occurs on the falling edge of $\overline{\text{LDAC}}$.

Table 14. Write Commands and $\overline{\text{LDAC}}$ Pin Truth Table¹

Commands	Description	Hardware $\overline{\text{LDAC}}$ Pin State	Input Register Contents	DAC Register Contents
0001	Write to Input Register n (dependent on $\overline{\text{LDAC}}$)	V _{LOGIC}	Data update	No change (no update)
		GND ²	Data update	Data update
0010	Update DAC Register n with contents of Input Register n	V _{LOGIC}	No change	Updated with input register contents
		GND	No change	Updated with input register contents
0011	Write to and update DAC Channel n	V _{LOGIC}	Data update	Data update
		GND	Data update	Data update

¹ A high to low hardware $\overline{\text{LDAC}}$ pin transition always updates the contents of the contents of the DAC register with the contents of the input register on channels that are not masked (blocked) by the $\overline{\text{LDAC}}$ mask register.

² When $\overline{\text{LDAC}}$ is permanently tied low, the $\overline{\text{LDAC}}$ mask bits are ignored.

$\overline{\text{LDAC}}$ MASK REGISTER

Command 0101 is reserved for this software $\overline{\text{LDAC}}$ function. Address bits are ignored. Writing to the DAC, using Command 0101, loads the 4-bit $\overline{\text{LDAC}}$ register (DB3 to DB0). The DB0, DB1, DB2, and DB3 bits correspond to DAC A, DAC B, DAC C, and DAC D, respectively.

The default for each channel is 0; that is, the $\overline{\text{LDAC}}$ pin works normally. Setting the bits to 1 forces this DAC channel to ignore transitions on the $\overline{\text{LDAC}}$ pin, regardless of the state of the hardware $\overline{\text{LDAC}}$ pin. This flexibility is useful in applications where the user wishes to select which channels respond to the $\overline{\text{LDAC}}$ pin.

Table 13. $\overline{\text{LDAC}}$ Overwrite Definition

Load $\overline{\text{LDAC}}$ Register		$\overline{\text{LDAC}}$ Operation
$\overline{\text{LDAC}}$ Bits (DB3 to DB0)	$\overline{\text{LDAC}}$ Pin	
0	1 or 0	Determined by the $\overline{\text{LDAC}}$ pin.
1	X ¹	DAC channels update and override the $\overline{\text{LDAC}}$ pin. DAC channels see $\overline{\text{LDAC}}$ as 1.

¹ X means don't care.

The $\overline{\text{LDAC}}$ register gives the user extra flexibility and control over the hardware $\overline{\text{LDAC}}$ pin (see Table 13). Setting the $\overline{\text{LDAC}}$ bits (DB0 to DB3) to 0 for a DAC channel means that this channel's update is controlled by the hardware $\overline{\text{LDAC}}$ pin.

HARDWARE RESET ($\overline{\text{RESET}}$)

$\overline{\text{RESET}}$ is an active low reset that allows the outputs to be cleared to either zero scale or midscale. The clear code value is user selectable via the reset select pin (RSTSEL). It is necessary to keep $\overline{\text{RESET}}$ low for a minimum amount of time to complete the operation (see Figure 2). When the $\overline{\text{RESET}}$ signal is returned high, the output remains at the cleared value until a new value is programmed. The outputs cannot be updated with a new value while the RESET pin is low. There is also a software executable reset function that resets the DAC to the power-on reset code. Command 0110 is designated for this software reset function (see Table 8). Any events on $\overline{\text{LDAC}}$ during a power-on reset are ignored. If the $\overline{\text{RESET}}$ pin is pulled low at power-up, the device does not initialize correctly until the pin is released.

RESET SELECT PIN (RSTSEL)

The AD5686R/AD5685R/AD5684R contain a power-on reset circuit that controls the output voltage during power-up. By connecting the RSTSEL pin low, the output powers up to zero scale. Note that this is outside the linear region of the DAC; by connecting the RSTSEL pin high, V_{OUT} powers up to midscale. The output remains powered up at this level until a valid write sequence is made to the DAC.

INTERNAL REFERENCE SETUP

The on-chip reference is on at power-up by default. To reduce the supply current, this reference can be turned off by setting software programmable bit, DB0, in the control register. Table 15 shows how the state of the bit corresponds to the mode of operation. Command 0111 is reserved for setting up the internal reference (see Figure 9). Table 15 shows how the state of the bits in the input shift register corresponds to the mode of operation of the device during internal reference setup.

Table 15. Reference Setup Register

Internal Reference Setup Register (DB0)	Action
0	Reference on (default)
1	Reference off

SOLDER HEAT REFLOW

As with all IC reference voltage circuits, the reference value experiences a shift induced by the soldering process. Analog Devices, Inc., performs a reliability test called precondition to mimic the effect of soldering a device to a board. The output voltage specification quoted previously includes the effect of this reliability test.

Figure 56 shows the effect of solder heat reflow (SHR) as measured through the reliability test (precondition).

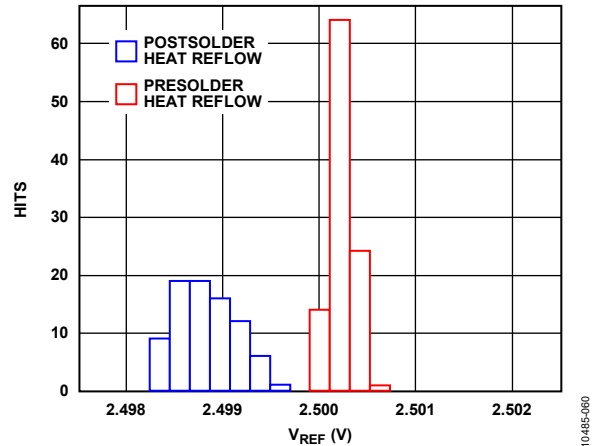

Figure 56. SHR Reference Voltage Shift

THERMAL HYSTERESIS

Thermal hysteresis is the voltage difference induced on the reference voltage by sweeping the temperature from ambient to cold, to hot, and then back to ambient.

Thermal hysteresis data is shown in Figure 57. It is measured by sweeping the temperature from ambient to -40°C , then to $+105^{\circ}\text{C}$, and returning to ambient. The V_{REF} delta is then measured between the two ambient measurements and shown in blue in Figure 57. The same temperature sweep and measurements were immediately repeated and the results are shown in red in Figure 57.

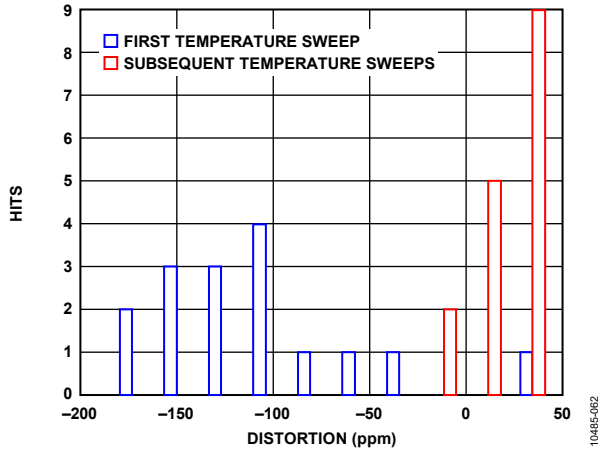

Figure 57. Thermal Hysteresis

LONG-TERM TEMPERATURE DRIFT

Figure 58 shows the change in the V_{REF} (ppm) value after 1000 hours at 25°C ambient temperature.

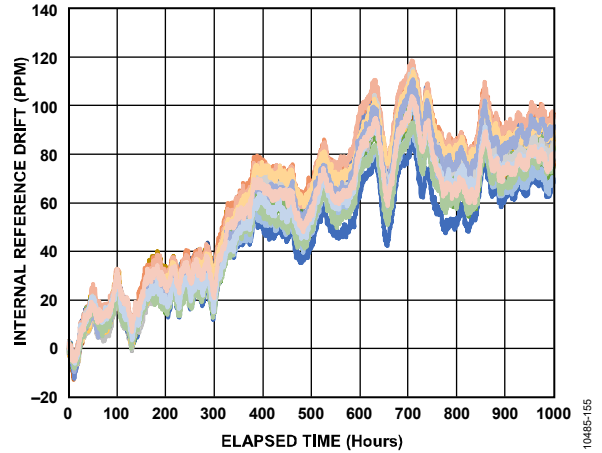

Figure 58. Reference Drift Through to 1000 Hours

Table 16. 24-Bit Input Shift Register Contents for Internal Reference Setup Command¹

DB23 (MSB)	DB22	DB21	DB20	DB19	DB18	DB17	DB16	DB15 to DB1	DB0 (LSB)
0	1	1	1	X	X	X	X	X	1/0
Command bits (C3 to C0)				Address bits (A2 to A0)				Don't care	Reference setup register

¹ X means don't care.

APPLICATIONS INFORMATION

MICROPROCESSOR INTERFACING

Microprocessor interfacing to the [AD5686R/AD5685R/AD5684R](#) is via a serial bus that uses a standard protocol that is compatible with DSP processors and microcontrollers. The communications channel requires a 3- or 4-wire interface consisting of a clock signal, a data signal, and a synchronization signal. The devices require a 24-bit data-word with data valid on the rising edge of SYNC.

AD5686R/AD5685R/AD5684R TO ADSP-BF531 INTERFACE

The SPI interface of the [AD5686R/AD5685R/AD5684R](#) is designed to be easily connected to industry-standard DSPs and microcontrollers. Figure 59 shows the [AD5686R/AD5685R/AD5684R](#) connected to the Analog Devices Blackfin® DSP. The Blackfin has an integrated SPI port that can be connected directly to the SPI pins of the [AD5686R/AD5685R/AD5684R](#).

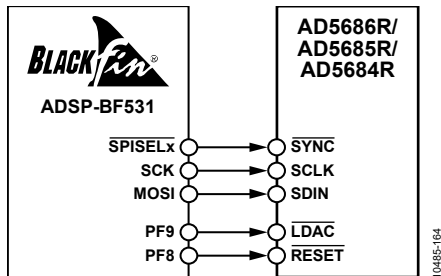

Figure 59. ADSP-BF531 Interface

AD5686R/AD5685R/AD5684R TO SPORT INTERFACE

The Analog Devices ADSP-BF527 has one SPORT serial port. Figure 60 shows how one SPORT interface can be used to control the [AD5686R/AD5685R/AD5684R](#).

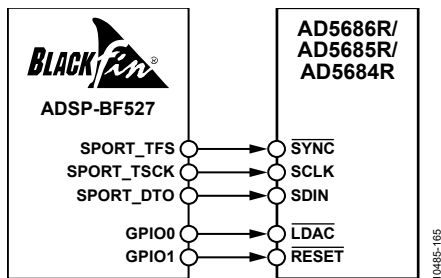

Figure 60. SPORT Interface

LAYOUT GUIDELINES

In any circuit where accuracy is important, careful consideration of the power supply and ground return layout helps to ensure the rated performance. The PCB on which the [AD5686R/AD5685R/AD5684R](#) are mounted should be designed so that the [AD5686R/AD5685R/AD5684R](#) lie on the analog plane.

The [AD5686R/AD5685R/AD5684R](#) should have ample supply bypassing of 10 μF in parallel with 0.1 μF on each supply, located as close to the package as possible, ideally right up against the device. The 10 μF capacitors are the tantalum bead type. The 0.1 μF capacitor should have low effective series resistance (ESR) and low effective series inductance (ESI) such as the common ceramic types, which provide a low impedance path to ground at high frequencies to handle transient currents due to internal logic switching.

In systems where there are many devices on one board, it is often useful to provide some heat sinking capability to allow the power to dissipate easily.

The [AD5686R/AD5685R/AD5684R](#) have an exposed paddle beneath the device. Connect this paddle to the GND supply for the part. For optimum performance, use special considerations to design the motherboard and to mount the package. For enhanced thermal, electrical, and board level performance, solder the exposed paddle on the bottom of the package to the corresponding thermal land paddle on the PCB. Design thermal vias into the PCB land paddle area to further improve heat dissipation.

The GND plane on the device can be increased (as shown in Figure 61) to provide a natural heat sinking effect.

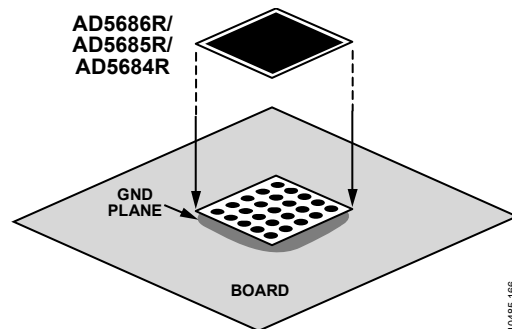
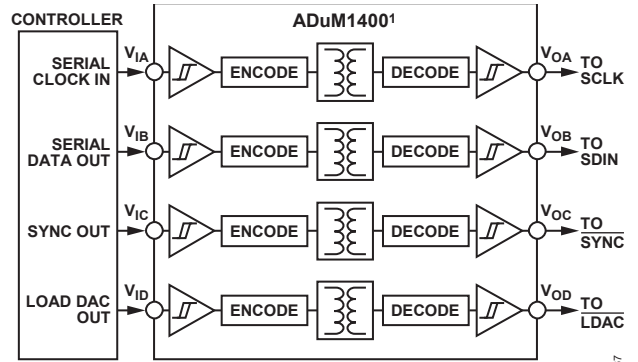

Figure 61. Paddle Connection to Board

GALVANICALLY ISOLATED INTERFACE

In many process control applications, it is necessary to provide an isolation barrier between the controller and the unit being controlled to protect and isolate the controlling circuitry from any hazardous common-mode voltages that may occur. *iCoupler*® products from Analog Devices provide voltage isolation in excess of 2.5 kV. The serial loading structure of the AD5686R/AD5685R/AD5684R makes the part ideal for isolated interfaces because the number of interface lines is kept to a minimum. Figure 62 shows a 4-channel isolated interface to the AD5686R/AD5685R/AD5684R using an ADuM1400. For further information, visit <http://www.analog.com/iCoupler>.



¹ADDITIONAL PINS OMITTED FOR CLARITY.

Figure 62. Isolated Interface

10485-167

OUTLINE DIMENSIONS

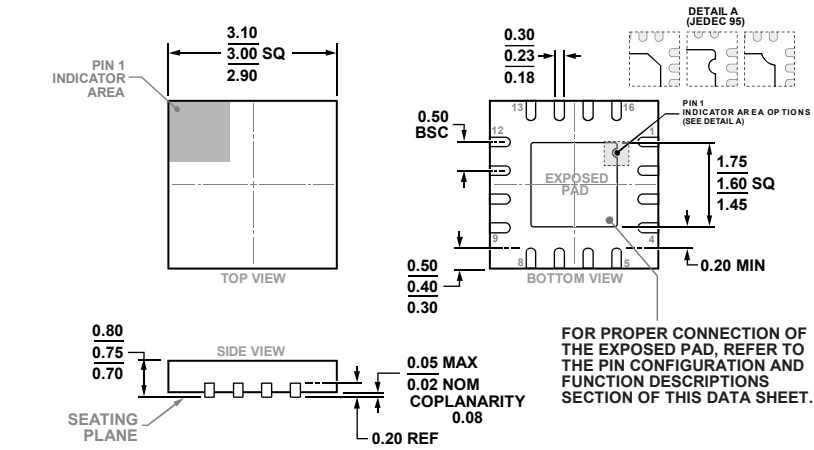

COMPLIANT TO JEDEC STANDARDS MO-220-WEED-6

Figure 63. 16-Lead Lead Frame Chip Scale Package [LFCSP]
3 mm × 3 mm Body and 0.75 mm Package Height
(CP-16-22)

Dimensions shown in millimeters

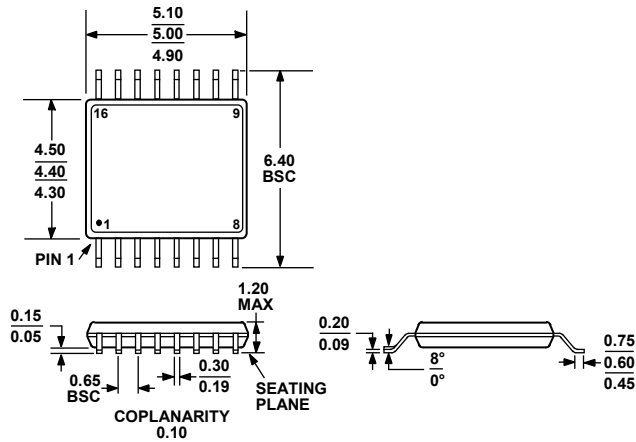

COMPLIANT TO JEDEC STANDARDS MO-153-AB

Figure 64. 16-Lead Thin Shrink Small Outline Package [TSSOP]
(RU-16)

Dimensions shown in millimeters

ORDERING GUIDE

Model ¹	Resolution	Temperature Range	Accuracy	Reference Tempco (ppm/°C)	Package Description	Package Option	Branding
AD5686RACPZ-RL7	16 Bits	-40°C to +105°C	±8 LSB INL	±5 (typ)	16-Lead LFCSP	CP-16-22	DJM
AD5686RBCPZ-RL7	16 Bits	-40°C to +105°C	±2 LSB INL	±5 (max)	16-Lead LFCSP	CP-16-22	DJN
AD5686RARUZ	16 Bits	-40°C to +105°C	±8 LSB INL	±5 (typ)	16-Lead TSSOP	RU-16	
AD5686RARUZ-RL7	16 Bits	-40°C to +105°C	±8 LSB INL	±5 (typ)	16-Lead TSSOP	RU-16	
AD5686RBRUZ	16 Bits	-40°C to +105°C	±2 LSB INL	±5 (max)	16-Lead TSSOP	RU-16	
AD5686RBRUZ-RL7	16 Bits	-40°C to +105°C	±2 LSB INL	±5 (max)	16-Lead TSSOP	RU-16	
AD5685RBCPZ-RL7	14 Bits	-40°C to +105°C	±1 LSB INL	±5 (max)	16-Lead LFCSP	CP-16-22	DJK
AD5685RARUZ	14 Bits	-40°C to +105°C	±4 LSB INL	±5 (typ)	16-Lead TSSOP	RU-16	
AD5685RARUZ-RL7	14 Bits	-40°C to +105°C	±4 LSB INL	±5 (typ)	16-Lead TSSOP	RU-16	
AD5685RBRUZ	14 Bits	-40°C to +105°C	±1 LSB INL	±5 (max)	16-Lead TSSOP	RU-16	
AD5685RBRUZ-RL7	14 Bits	-40°C to +105°C	±1 LSB INL	±5 (max)	16-Lead TSSOP	RU-16	
AD5684RBCPZ-RL7	12 Bits	-40°C to +105°C	±1 LSB INL	±5 (max)	16-Lead LFCSP	CP-16-22	DJG
AD5684RARUZ	12 Bits	-40°C to +105°C	±2 LSB INL	±5 (typ)	16-Lead TSSOP	RU-16	
AD5684RARUZ-RL7	12 Bits	-40°C to +105°C	±2 LSB INL	±5 (typ)	16-Lead TSSOP	RU-16	
AD5684RBRUZ	12 Bits	-40°C to +105°C	±1 LSB INL	±5 (max)	16-Lead TSSOP	RU-16	
AD5684RBRUZ-RL7	12 Bits	-40°C to +105°C	±1 LSB INL	±5 (max)	16-Lead TSSOP	RU-16	
EVAL-AD5686RSDZ					AD5686R TSSOP Evaluation Board		
EVAL-AD5684RSDZ					AD5684R TSSOP Evaluation Board		

¹ Z = RoHS Compliant Part.

X-ON Electronics

Largest Supplier of Electrical and Electronic Components

Click to view similar products for [Digital to Analog Converters - DAC category](#):

Click to view products by [Analog Devices manufacturer](#):

Other Similar products are found below :

[HI5660/6IA](#) [HI5660IB](#) [HI5731BIB](#) [HI5741BIBZ](#) [HI5760BIB](#) [HI5860IB](#) [ISL5629IN](#) [ISL5729IN](#) [ISL5857IA](#) [ISL5857IB](#) [ISL5861IB](#)
[ISL5927IN](#) [ISL5961IA](#) [TLV5614IDR](#) [AD5689RBRUZ-RL7](#) [AD7528JPZ-REEL](#) [AD5064BRUZ-1REEL7](#) [AD5664RBRMZ-5REEL7](#)
[MS5620](#) [DAC60508ZRTER](#) [DAC8411IDCKR](#) [AD5676RARUZ-REEL7](#) [LTC2654BIGN-L16#PBF](#) [AD5781ARUZ-REEL7](#)
[AD5667RBRMZ-2REEL7](#) [AD5686RBRUZ-RL7](#) [AD5696BRUZ-RL7](#) [MS5314](#) [DAC8560IDDGKR](#) [DAC81401PWR](#) [DAC8728SPAGR](#)
[ADV7125BCPZ170-RL](#) [LTC2642CMS-12#TRPBF](#) [AD5413BCPZ-RL7](#) [AD5541ARZ-REEL7](#) [AD5732AREZ-REEL7](#) [AD5640CRMZ-](#)
[2REEL7](#) [LTC2642CMS-16#TRPBF](#) [AD5781BRUZ-REEL7](#) [LTC1658IMS8#TRPBF](#) [AD5674RBCPZ-1-RL7](#) [AD5667RBRMZ-1REEL7](#)
[AD5449YRUZ-REEL](#) [LTC2621IDD-1#TRPBF](#) [AD5648BRUZ-2REEL7](#) [LTC2633AHTS8-LI12#TRMPBF](#) [CLM5615ID](#) [MS5541](#) [MS4344](#)
[MS5542](#)