



Industrial I/V Output Driver, Single-Supply, 55 V Maximum Supply, Programmable Ranges

Data Sheet

AD5751

FEATURES

**Current output ranges: 0 mA to 20 mA, 0 mA to 24 mA,
or 4 mA to 20 mA**

±0.03% FSR typical total unadjusted error (TUE)

±5 ppm/°C typical output drift

2% overrange

Voltage output ranges: 0 V to 5 V, 0 V to 10 V, 0 V to 40 V

±0.02% FSR typical total unadjusted error (TUE)

±3 ppm/°C typical output drift

Overrange capability on all ranges

Flexible serial digital interface

On-chip output fault detection

PEC error checking

Asynchronous CLEAR function

Power supply range

AV_{DD}: 12 V (± 10%) to 55 V (maximum)

Output loop compliance to AV_{DD} – 2.75 V

Temperature range: –40°C to +105°C

32-lead 5 mm × 5 mm LFCSP package

APPLICATIONS

Process control

Actuator control

PLCs

GENERAL DESCRIPTION

The AD5751 is a single-channel, low cost, precision, voltage/current output driver with hardware or software programmable output ranges. The software ranges are configured via an SPI-/MICROWIRE™-compatible serial interface. The AD5751 targets applications in PLC and industrial process control. The analog input to the AD5751 is provided from a low voltage, single-supply digital-to-analog converter (DAC) and is internally conditioned to provide the desired output current/voltage range.

The output current range is programmable across three current ranges: 0 mA to 20 mA, 0 mA to 24 mA, or 4 mA to 20 mA.

Voltage output is provided from a separate pin that can be configured to provide 0 V to 5 V, 0 V to 10 V, and 0 V to 40 V output ranges. An overrange is available on the voltage ranges.

Analog outputs are short-circuit and open-circuit protected and can drive capacitive loads of 1 μF and inductive loads of 0.1 H.

The device is specified to operate with a power supply range from 10.8 V to 55 V. Output loop compliance is 0 V to AV_{DD} – 2.75 V.

The flexible serial interface is SPI and MICROWIRE compatible and can be operated in 3-wire mode to minimize the digital isolation required in isolated applications. The interface also features an optional PEC error checking feature using CRC-8 error checking, useful in industrial environments where data communication corruption can occur.

The device also includes a power-on reset function ensuring that the device powers up in a known state (0 V or tristate) and an asynchronous CLEAR pin that sets the outputs to zero-scale/midscale voltage output or the low end of the selected current range.

An HW SELECT pin is used to configure the part for hardware or software mode on power-up.

Table 1. Related Device

| Part Number | Description |
|-------------|--|
| AD5422 | Single-channel, 16-bit, serial input current source and voltage output DAC |

Rev. E

[Document Feedback](#)

Information furnished by Analog Devices is believed to be accurate and reliable. However, no responsibility is assumed by Analog Devices for its use, nor for any infringements of patents or other rights of third parties that may result from its use. Specifications subject to change without notice. No license is granted by implication or otherwise under any patent or patent rights of Analog Devices. Trademarks and registered trademarks are the property of their respective owners.

One Technology Way, P.O. Box 9106, Norwood, MA 02062-9106, U.S.A.
Tel: 781.329.4700 ©2009–2020 Analog Devices, Inc. All rights reserved.
[Technical Support](#) www.analog.com

TABLE OF CONTENTS

| | | | |
|---|----|--|----|
| Features | 1 | OUTEN..... | 24 |
| Applications | 1 | Software Control | 24 |
| General Description | 1 | Hardware Control..... | 26 |
| Revision History | 2 | Transfer Function | 26 |
| Functional Block Diagram | 3 | Detailed Description of Features..... | 27 |
| Specifications | 4 | Output Fault Alert—Software Mode..... | 27 |
| Timing Characteristics | 7 | Output Fault Alert—Hardware Mode | 27 |
| Absolute Maximum Ratings | 9 | Voltage Output Short-Circuit Protection..... | 27 |
| ESD Caution..... | 9 | Asynchronous Clear (CLEAR)..... | 27 |
| Pin Configuration and Function Descriptions | 10 | External Current Setting Resistor | 27 |
| Typical Performance Characteristics..... | 12 | Programmable Overrange Modes..... | 28 |
| Current Output..... | 15 | Packet Error Checking | 28 |
| Terminology..... | 20 | Applications Information | 29 |
| Theory of Operation | 21 | Transient Voltage Protection | 29 |
| Software Mode..... | 21 | Thermal Considerations | 29 |
| Current Output Architecture..... | 23 | Layout Guidelines | 30 |
| Driving Inductive Loads..... | 23 | Galvanically Isolated Interface | 30 |
| Power-On State of the AD5751 | 23 | Microprocessor Interfacing | 30 |
| Default Registers at Power-On..... | 24 | Outline Dimensions..... | 31 |
| Reset Function | 24 | Ordering Guide | 31 |

REVISION HISTORY

9/2020—Rev. D to Rev. E

| | |
|---------------------------------|------------|
| Changed CP-32-2 to CP-32-7..... | Throughout |
| Changes to Figure 4..... | 10 |
| Updated Outline Dimensions..... | 31 |
| Changes to Ordering Guide..... | 31 |

1/2018—Rev. C to Rev. D

| | |
|---------------------------------|------------|
| Changed CP-32-7 to CP-32-2..... | Throughout |
| Changes to Figure 4..... | 10 |
| Updated Outline Dimensions..... | 31 |
| Changes to Ordering Guide..... | 31 |

3/2017—Rev. B to Rev. C

| | |
|----------------------------------|------------|
| Changed CP-32-2 to CP-32-7..... | Throughout |
| Changes to Figure 4 | 10 |
| Updated Outline Dimensions | 31 |
| Changes to Ordering Guide..... | 31 |

10/2013—Rev. A to Rev. B

| | |
|---|----|
| Changed Thermal Impedance from 28°C/W to 42°C/W (Throughout) | 9 |
| Added Endnote 1 to Table 4 | 9 |
| Changes to Table 12 Calculations..... | 29 |
| Updated Outline Dimensions | 31 |

5/2010—Rev. 0 to Rev. A

| | |
|--|---|
| Changes to Table 2, Power Requirements | 6 |
|--|---|

10/2009—Revision 0: Initial Version

FUNCTIONAL BLOCK DIAGRAM

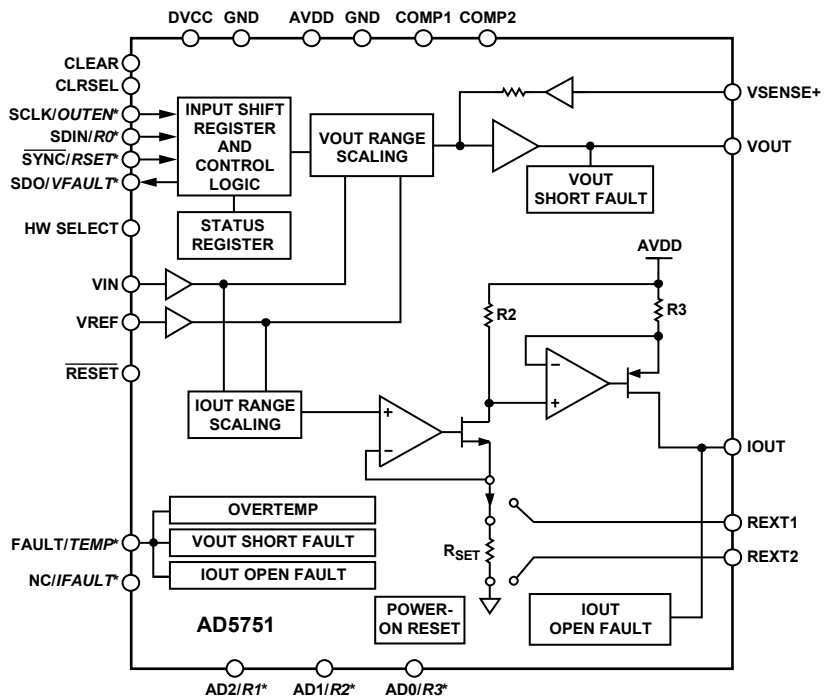

*DENOTES SHARED PIN. SOFTWARE MODE DENOTED BY REGULAR TEXT, HARDWARE MODE DENOTED BY *ITALIC* TEXT. FOR EXAMPLE, FOR FAULT/*TEMP* PIN, IN SOFTWARE MODE, THIS PIN TAKES ON FAULT FUNCTION. IN HARDWARE MODE, THIS PIN TAKES ON *TEMP* FUNCTION.

Figure 1. Functional Block Diagram

07289-001

SPECIFICATIONS

$AV_{DD} = 12\text{ V}$ ($\pm 10\%$) to 55 V (maximum), $DV_{CC} = 2.7\text{ V}$ to 5.5 V , $GND = 0\text{ V}$. I_{OUT} : $R_{LOAD} = 300\ \Omega$. All specifications T_{MIN} to T_{MAX} , unless otherwise noted.

Table 2.

| Parameter ¹ | Min | Typ | Max | Unit | Test Conditions/Comments |
|--|-------|-------------|-------|---------------------------|---|
| INPUT VOLTAGE RANGE | | | | | Output unloaded |
| Input Leakage Current | -1 | 0 to 4.096 | +1 | V μA | |
| REFERENCE INPUT | | | | | |
| Reference Input Voltage | | 4.096 | | V | External reference must be exactly as stated; otherwise, accuracy errors show up as error in output |
| Input Leakage Current | -1 | | +1 | μA | |
| VOLTAGE OUTPUT | | | | | |
| Output Voltage Ranges | 0 | | 5 | V | AVDD must have minimum 1.3 V headroom or >11.3 V |
| | 0 | | 10 | V | |
| Output Voltage Overranges ² | 0 | | 40 | V | Programmable overranges; see Detailed Description of Features section |
| | 0 | | 6 | V | |
| | 0 | | 12 | V | |
| | 0 | | 44 | V | |
| Accuracy | | | | | |
| Total Unadjusted Error (TUE) | | | | | |
| B Version ³ | -0.1 | | +0.1 | % FSR | $T_A = 25^\circ\text{C}$ |
| | -0.05 | ± 0.02 | +0.05 | % FSR | |
| A Version ³ | -0.3 | | +0.3 | % FSR | $T_A = 25^\circ\text{C}$ |
| | -0.1 | ± 0.05 | +0.1 | % FSR | |
| Relative Accuracy (INL) | -0.02 | ± 0.005 | +0.02 | % FSR | |
| Dead Band on Output, RTI | -14 | 8 | +14 | mV | Referred to 4.096 V input range |
| Offset Error | -5 | | +5 | mV | 0 V to 10 V range |
| | -4 | ± 0.5 | +4 | mV | $T_A = 25^\circ\text{C}$, 0 V to 10 V range |
| | -3 | | +3 | mV | 0 V to 5 V range |
| | -2.2 | ± 0.3 | +2.2 | mV | $T_A = 25^\circ\text{C}$, 0 V to 5 V range |
| | -20 | | +20 | mV | 0 V to 40 V range |
| | -17 | ± 0.5 | +17 | mV | $T_A = 25^\circ\text{C}$, 0 V to 40 V range |
| Gain Error | -0.05 | | +0.05 | % FSR | 0 V to 5 V, 0 V to 10 V range |
| | -0.04 | ± 0.015 | +0.04 | % FSR | $T_A = 25^\circ\text{C}$ |
| | -0.09 | | +0.09 | % FSR | 0 V to 40 V range |
| | -0.05 | ± 0.02 | +0.05 | % FSR | $T_A = 25^\circ\text{C}$ |
| Gain Error TC^4 | | ± 0.5 | | ppm FSR/ $^\circ\text{C}$ | All ranges |
| Full-Scale Error | -0.05 | | +0.05 | % FSR | 0 V to 5 V, 0 V to 10 V range |
| | -0.04 | ± 0.015 | +0.04 | % FSR | $T_A = 25^\circ\text{C}$ |
| | -0.09 | | +0.09 | % FSR | 0 V to 40 V range |
| | -0.05 | ± 0.02 | +0.05 | % FSR | $T_A = 25^\circ\text{C}$ |
| Full-Scale Error TC^4 | | ± 1.5 | | ppm FSR/ $^\circ\text{C}$ | All ranges |
| OUTPUT CHARACTERISTICS ⁴ | | | | | |
| Headroom | | | 1.3 | V | Output unloaded |
| Short-Circuit Current | | 15 | | mA | |
| Load | | | | | |
| | 1 | | | k Ω | For specified performance, 0 V to 5 V and 0 V to 10 V ranges |
| | 5 | | | k Ω | For specified performance, 0 V to 40 V range |

| Parameter ¹ | Min | Typ | Max | Unit | Test Conditions/Comments |
|--|--------|------------|--------|------------------------------|--|
| Capacitive Load Stability | | | | | $T_A = 25^\circ\text{C}$ |
| $R_{\text{LOAD}} = \infty$ | | | 1 | nF | |
| $R_{\text{LOAD}} = 1\text{ k}\Omega$ | | | 1 | nF | |
| $R_{\text{LOAD}} = \infty$ | | | 2 | μF | External compensation capacitor required; see Driving Large Capacitive Loads section |
| DC Output Impedance | | 0.12 | | Ω | |
| Settling Time | | | | | |
| 0 V to 5 V Range, $\frac{1}{4}$ to $\frac{3}{4}$ Step | | 7 | | μs | Specified with $2\text{ k}\Omega \parallel 220\text{ pF}$, $\pm 0.05\%$ |
| 0 V to 5 V Range, 40 mV Input Step | | 4.5 | | μs | Specified with $2\text{ k}\Omega \parallel 220\text{ pF}$, $\pm 0.05\%$ |
| 0 V to 40 V Range, $\frac{1}{4}$ to $\frac{3}{4}$ Step | | 15.8 | | μs | Specified with $5\text{ k}\Omega \parallel 220\text{ pF}$, $\pm 0.05\%$ |
| Slew Rate | | 2 | | $\text{V}/\mu\text{s}$ | Specified with $1\text{ k}\Omega \parallel 220\text{ pF}$ |
| Output Noise | | 3.5 | | $\mu\text{V rms}$ | 0.1 Hz to 10 Hz bandwidth |
| | | 45.5 | | $\mu\text{V rms}$ | 100 kHz bandwidth; specified with $2\text{ k}\Omega \parallel 220\text{ pF}$ |
| Output Noise Spectral Density | | 165 | | $\text{nV}/\sqrt{\text{Hz}}$ | Measured at 10 kHz; specified with $2\text{ k}\Omega \parallel 220\text{ pF}$ |
| AC PSRR | | 65 | | dB | 200 mV, 50 Hz/60 Hz sine wave superimposed on power supply voltage |
| DC PSRR | | 10 | | $\mu\text{V}/\text{V}$ | |
| CURRENT OUTPUT | | | | | |
| Output Current Ranges | 0 | | 24 | mA | |
| | 0 | | 20 | mA | |
| | 3.92 | | 20 | mA | |
| Output Current Overranges ² | 0 | | 24.5 | mA | See Detailed Description of Features section |
| | 0 | | 20.4 | mA | See Detailed Description of Features section |
| | 3.92 | | 20.4 | mA | See Detailed Description of Features section |
| ACCURACY (INTERNAL R_{SET}) | | | | | |
| Total Unadjusted Error (TUE) | | | | | |
| B Version ³ | -0.2 | | +0.2 | % FSR | $T_A = 25^\circ\text{C}$ |
| | -0.08 | ± 0.03 | +0.08 | % FSR | |
| A Version ³ | -0.5 | | +0.5 | % FSR | $T_A = 25^\circ\text{C}$ |
| | -0.3 | ± 0.15 | +0.3 | % FSR | |
| Relative Accuracy (INL) | -0.02 | ± 0.01 | +0.02 | % FSR | |
| Offset Error | -16 | | +16 | μa | $T_A = 25^\circ\text{C}$ |
| | -10 | +5 | +10 | μa | |
| Offset Error TC^4 | | ± 3 | | ppm FSR/ $^\circ\text{C}$ | |
| Dead Band on Output, RTI | | 8 | +14 | mV | Referred to 4.096 V input range |
| Gain Error | -0.2 | | +0.2 | % FSR | |
| | -0.125 | ± 0.02 | +0.125 | % FSR | $T_A = 25^\circ\text{C}$ |
| Gain TC^4 | | ± 10 | | ppm FSR/ $^\circ\text{C}$ | |
| Full-Scale Error | -0.2 | | +0.2 | % FSR | |
| | -0.125 | ± 0.02 | +0.125 | % FSR | $T_A = 25^\circ\text{C}$ |
| Full-Scale TC^4 | | ± 4 | | ppm FSR/ $^\circ\text{C}$ | |
| ACCURACY (EXTERNAL R_{SET}) | | | | | |
| Total Unadjusted Error (TUE) | | | | | |
| B Version ³ | -0.1 | | +0.1 | % FSR | $T_A = 25^\circ\text{C}$ |
| | -0.08 | ± 0.03 | +0.08 | % FSR | |
| A Version ³ | -0.3 | | +0.3 | % FSR | $T_A = 25^\circ\text{C}$ |
| | -0.1 | ± 0.02 | +0.1 | % FSR | |
| Relative Accuracy (INL) | -0.02 | ± 0.01 | +0.02 | % FSR | |
| Offset Error | -14 | | +14 | μA | $T_A = 25^\circ\text{C}$ |
| | -11 | +5 | +11 | μA | |
| Offset Error TC^4 | | ± 2 | | ppm FSR/ $^\circ\text{C}$ | |
| Dead Band on Output, RTI | | 8 | +14 | mV | Referred to 4.096 V input range |
| Gain Error | -0.08 | | +0.08 | % FSR | |
| | -0.07 | ± 0.02 | +0.07 | % FSR | $T_A = 25^\circ\text{C}$ |

| Parameter ¹ | Min | Typ | Max | Unit | Test Conditions/Comments |
|---|-------------------------------------|------------|-------------------------|------------|--|
| Gain TC ⁴ | | ±1 | | ppm FSR/°C | |
| Full-Scale Error | -0.1 | | +0.1 | % FSR | T _A = 25°C |
| | -0.07 | ±0.02 | +0.07 | % FSR | |
| Full-Scale TC ⁴ | | ±2 | | ppm FSR/°C | |
| OUTPUT CHARACTERISTICS⁴ | | | | | |
| Current Loop Compliance Voltage Resistive Load | 0 | | AV _{DD} - 2.75 | V | Chosen such that compliance is not exceeded |
| Inductive Load | See test conditions/comments column | | | H | Needs appropriate capacitor at higher inductance values; see Driving Inductive Loads section |
| Settling Time 4 mA to 20 mA, Full-Scale Step | | 8.5 | | μs | 250 Ω load |
| 120 μA Step, 4 mA to 20 mA Range | | 1.2 | | μs | 250 Ω load |
| DC PSRR | | | 1 | μA/V | |
| Output Impedance | | 130 | | MΩ | |
| DIGITAL INPUTS⁴ | | | | | |
| Input High Voltage, V _{IH} | 2 | | | V | JEDEC compliant |
| Input Low Voltage, V _{IL} | | | 0.8 | V | |
| Input Current | -1 | | +1 | μA | Per pin |
| Pin Capacitance | | 5 | | pF | Per pin |
| DIGITAL OUTPUTS⁴ | | | | | |
| FAULT, IFAULT, TEMP, VFAULT V _{OL} , Output Low Voltage | | 0.6 | 0.4 | V | 10 kΩ pull-up resistor to DVCC |
| V _{OH} , Output High Voltage | 3.6 | | | V | At 2.5 mA |
| SDO | | | | V | 10 kΩ pull-up resistor to DVCC |
| V _{OL} , Output Low Voltage | 0.5 | 0.5 | | V | Sinking 200 μA |
| V _{OH} , Output High Voltage | DVCC - 0.5 | DVCC - 0.5 | | V | Sourcing 200 μA |
| High Impedance Output Capacitance | | 3 | | pF | |
| High Impedance Leakage Current | -1 | | +1 | μA | |
| POWER REQUIREMENTS | | | | | |
| AV _{DD} | 10.8 | | 55 | V | |
| DV _{CC} | | | | | |
| Input Voltage | 2.7 | | 5.5 | V | |
| AI _{DD} | | 4.4 | 5.6 | mA | Output unloaded, output disabled |
| | | 5.2 | 6.2 | mA | Current output enabled |
| | | 5.2 | 6.2 | mA | Voltage output enabled |
| DI _{CC} | | 0.3 | 1 | mA | V _{IH} = DVCC, V _{IL} = GND |
| Power Dissipation | | 108 | | mW | AVDD = 24 V, outputs unloaded |

¹ Temperature range: -40°C to +105°C; typical at +25°C.

² Overranges are nominal; gain and offset are not trimmed as per nominal ranges.

³ Specification includes gain and offset errors, over temperature, and drift after 1000 hours, T_A = 125°C.

⁴ Guaranteed by characterization, but not production tested.

TIMING CHARACTERISTICS

$AV_{DD} = 12\text{ V } (\pm 10\%) \text{ to } 55\text{ V (maximum)}$, $DV_{CC} = 2.7\text{ V to } 5.5\text{ V}$, $GND = 0\text{ V}$. V_{OUT} : $R_{LOAD} = 2\text{ k}\Omega$ (5 k Ω for 0 V to 40 V range), $C_L = 200\text{ pF}$, I_{OUT} : $R_{LOAD} = 300\text{ }\Omega$. All specifications T_{MIN} to T_{MAX} , unless otherwise noted.

Table 3.

| Parameter ^{1,2} | Limit at T_{MIN} , T_{MAX} | Unit | Description |
|--------------------------|--------------------------------|-------------------|--|
| t_1 | 20 | ns min | SCLK cycle time |
| t_2 | 8 | ns min | SCLK high time |
| t_3 | 8 | ns min | SCLK low time |
| t_4 | 5 | ns min | \overline{SYNC} falling edge to SCLK falling edge setup time |
| t_5 | 10 | ns min | 16 th SCLK falling edge to \overline{SYNC} rising edge (on 24 th SCLK falling edge if using PEC) |
| t_6 | 5 | ns min | Minimum \overline{SYNC} high time (write mode) |
| t_7 | 5 | ns min | Data setup time |
| t_8 | 5 | ns min | Data hold time |
| t_9, t_{10} | 1.5 | $\mu\text{s max}$ | CLEAR pulse low/high activation time |
| t_{11} | 5 | ns min | Minimum \overline{SYNC} high time (read mode) |
| t_{12} | 40 | ns max | SCLK rising edge to SDO valid ($SDO C_L = 15\text{ pF}$) |
| t_{13} | 10 | ns min | \overline{RESET} pulse low time |

¹ Guaranteed by characterization, but not production tested.

² All input signals are specified with $t_r = t_f = 5\text{ ns}$ (10% to 90% of DV_{CC}) and timed from a voltage level of 1.2 V.

Timing Diagrams

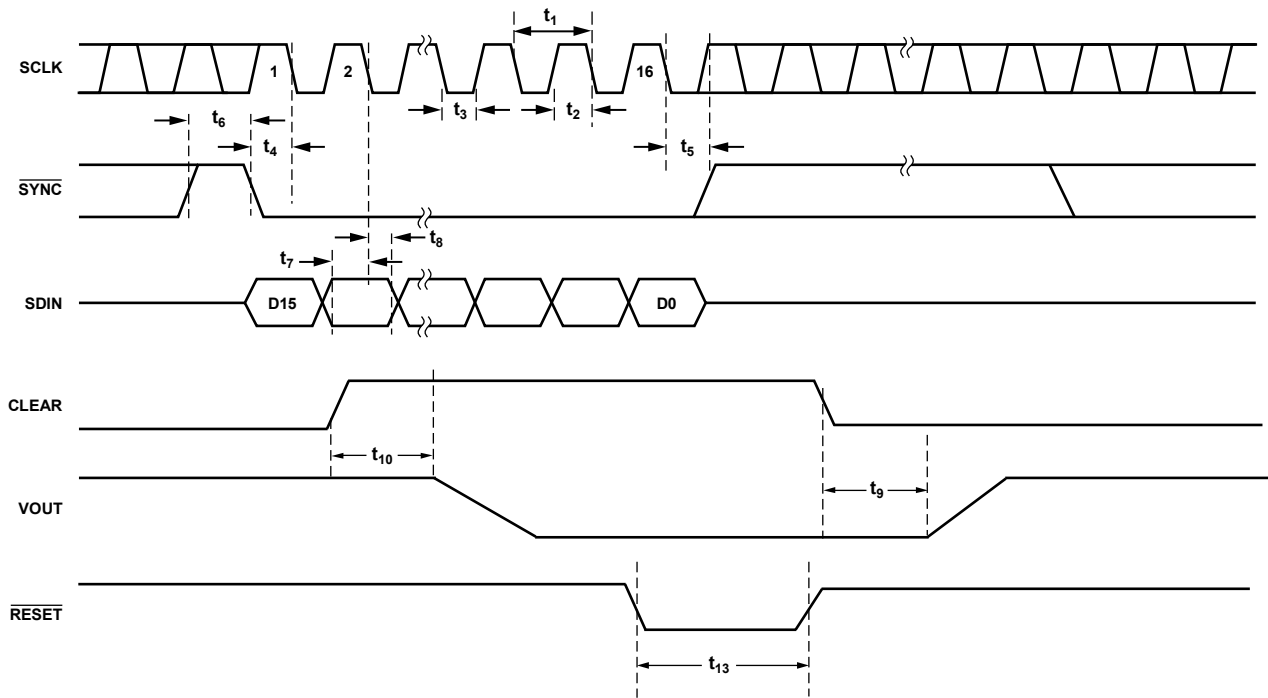

Figure 2. Write Mode Timing Diagram

07268-003

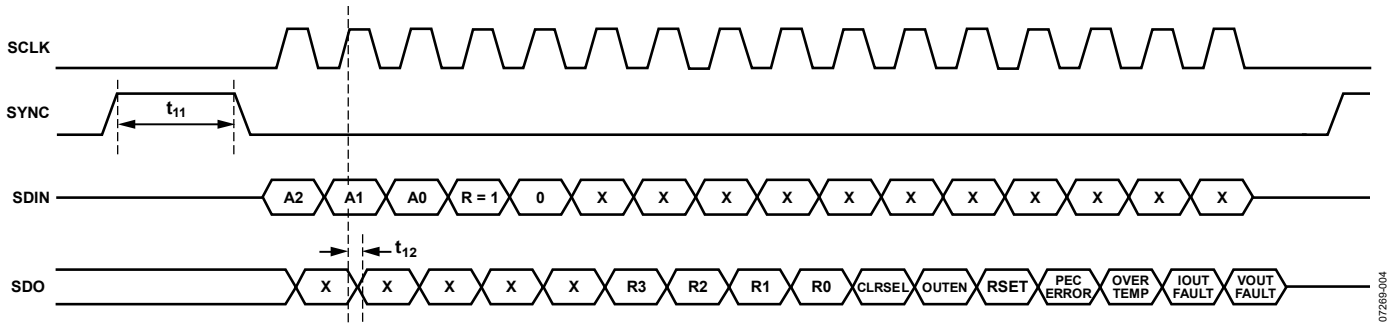

Figure 3. Readback Mode Timing Diagram

07289-004

ABSOLUTE MAXIMUM RATINGS

$T_A = 25^\circ\text{C}$, unless otherwise noted. Transient currents of up to 100 mA do not cause SCR latch-up.

Table 4.

| Parameter | Rating |
|--|---|
| AVDD to GND | −0.3 V to +58 V |
| DVCC to GND | −0.3 V to +7 V |
| Digital Inputs to GND | −0.3 V to $DV_{CC} + 0.3\text{ V}$, or 7 V (whichever is less) |
| Digital Outputs to GND | −0.3 V to $DV_{CC} + 0.3\text{ V}$, or 7 V (whichever is less) |
| VREF to GND | −0.3 V to +7 V |
| VSENSE+ to GND | −0.3 V to AV_{DD} |
| VIN to GND | −0.3 V to +7 V |
| VOUT, IOUT to GND | −0.3 V to AV_{DD} |
| Operating Temperature Range | |
| Industrial | −40°C to +105°C |
| Storage Temperature Range | −65°C to +150°C |
| Junction Temperature (T_J max) | 125°C |
| 32-Lead LFCSP Package | |
| θ_{JA} Thermal Impedance ¹ | 42°C/W |
| Lead Temperature | JEDEC industry standard |
| Soldering | J-STD-020 |

¹ Simulated data based on a JEDEC 2s2p test board with thermal vias.

Stresses at or above those listed under Absolute Maximum Ratings may cause permanent damage to the product. This is a stress rating only; functional operation of the product at these or any other conditions above those indicated in the operational section of this specification is not implied. Operation beyond the maximum operating conditions for extended periods may affect product reliability.

ESD CAUTION



ESD (electrostatic discharge) sensitive device. Charged devices and circuit boards can discharge without detection. Although this product features patented or proprietary protection circuitry, damage may occur on devices subjected to high energy ESD. Therefore, proper ESD precautions should be taken to avoid performance degradation or loss of functionality.

PIN CONFIGURATION AND FUNCTION DESCRIPTIONS

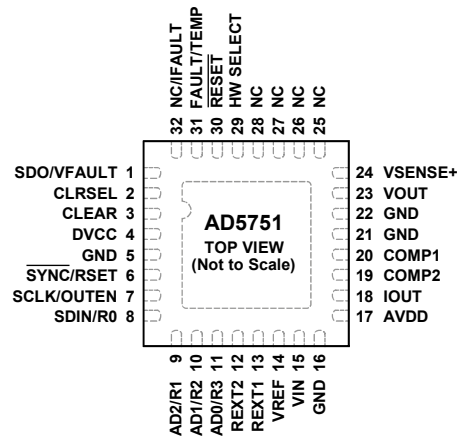

NOTES

1. NC = NO CONNECT. CAN BE TIED TO GND.
2. THE EXPOSED PADDLE IS TIED TO GND.

07268-005

Figure 4. Pin Configuration

Table 5. Pin Function Descriptions

| Pin No. | Mnemonic | Description |
|---------|------------|--|
| 1 | SDO/VFAULT | Serial Data Output (SDO). In software mode, this pin is used to clock data from the input shift register in readback mode. Data is clocked out on the rising edge of SCLK and is valid on the falling edge of SCLK. This pin is a CMOS output. Short-Circuit Fault Alert (VFAULT). In hardware mode, this pin acts as a short-circuit fault alert pin and is asserted low when a short-circuit error is detected. This pin is an open-drain output and must be connected to a pull-up resistor. |
| 2 | CLRSEL | In hardware or software mode, this pin selects the clear value, either zero-scale or midscale code. In software mode, this pin is implemented as a logic OR with the internal CLRSEL bit. |
| 3 | CLEAR | Active High Input. Asserting this pin sets the output current/voltage to zero-scale code or midscale code of range selected (user-selectable). CLEAR is a logic OR with the internal clear bit. See the Asynchronous Clear (CLEAR) section for more details. In software mode, during power-up, the CLEAR pin level determines the power-on condition of the voltage channel, which can be active 0 V or tristate. |
| 4 | DVCC | Digital Power Supply. |
| 5 | GND | Ground Connection. |
| 6 | SYNC/RSET | Positive Edge-Sensitive Latch (SYNC). In software mode, a rising edge parallel loads the input shift register data into the AD5751, also updating the output. Resistor Select (RSET). In hardware mode, this pin selects whether the internal or the external current sense resistor is used. If RSET = 0, the external sense resistor is chosen. If RSET = 1, the internal sense resistor is chosen. |
| 7 | SCLK/OUTEN | Serial Clock Input (SCLK). In software mode, data is clocked into the input shift register on the falling edge of SCLK. This pin operates at clock speeds up to 50 MHz. Output Enable (OUTEN). In hardware mode, this pin acts as an output enable pin. |
| 8 | SDIN/R0 | Serial Data Input (SDIN). In software mode, data must be valid on the falling edge of SCLK. Range Decode Bit (R0). In hardware mode, this pin, in conjunction with R1, R2, and R3, selects the output current/voltage range setting on the part. |
| 9 | AD2/R1 | Device Addressing Bit (AD2). In software mode, this pin, in conjunction with AD0 and AD1, allows up to eight devices to be addressed on one bus. Range Decode Bit (R1). In hardware mode, this pin, in conjunction with R0, R2, and R3, selects the output current/voltage range setting on the part. |

| Pin No. | Mnemonic | Description |
|----------------|---------------------------|---|
| 10 | AD1/R2 | Device Addressing Bit (AD1). In software mode, this pin, in conjunction with AD0 and AD2, allows up to eight devices to be addressed on one bus. Range Decode Bit (R2). In hardware mode, this pin, in conjunction with R0, R1, and R3, selects the output current/voltage range setting on the part. |
| 11 | AD0/R3 | Device Addressing Bit (AD0). In software mode, this pin, in conjunction with AD1 and AD2, allows up to eight devices to be addressed on one bus. Range Decode Bit (R3). In hardware mode, this pin, in conjunction with R0, R1, and R2, selects the output current/voltage range setting on the part. |
| 12, 13 | REXT2, REXT1 | A 15 k Ω external current setting resistor can be connected between the REXT1 and REXT2 pins to improve the IOUT temperature drift performance. |
| 14 | VREF | Buffered Reference Input. |
| 15 | VIN | Buffered Analog Input (0 V to 4.096 V). |
| 16 | GND | Ground Connection. |
| 17 | AVDD | Positive Analog Supply. |
| 18 | IOUT | Current Output. |
| 19, 20 | COMP2, COMP1 | Optional Compensation Capacitor Connections for the Voltage Output Buffer. These are used to drive higher capacitive loads on the output. These pins also reduce overshoot on the output. Care should be taken when choosing the value of the capacitor connected between the COMP1 and COMP2 pins because it has a direct influence on the settling time of the output. See the Driving Large Capacitive Loads section for further details. |
| 21 | GND | Ground Connection. |
| 22 | GND | Ground Connection. |
| 23 | VOUT | Buffered Analog Output Voltage. |
| 24 | VSENSE+ | Sense Connection for the Positive Voltage Output Load Connection. |
| 25, 26, 27, 28 | NC | No Connect. Can be tied to GND. |
| 29 | HW SELECT | This part is used to configure the part to hardware or software mode. HW SELECT = 0 selects software control. HW SELECT = 1 selects hardware control. |
| 30 | $\overline{\text{RESET}}$ | In software mode, this pin resets the part to its power-on state. Active low. In hardware mode, there is no reset. If using the part in hardware mode, the $\overline{\text{RESET}}$ pin should be tied high. |
| 31 | FAULT/TEMP | Fault Alert (FAULT). In software mode, this pin acts as a general fault alert pin. It is asserted low when an open-circuit, short-circuit, overtemperature error, or PEC interface error is detected. This pin is an open-drain output and must be connected to a pull-up resistor. Overtemperature Fault (TEMP). In hardware mode, this pin acts as an overtemperature fault pin. It is asserted low when an overtemperature error is detected. This pin is an open-drain output and must be connected to a pull-up resistor. |
| 32 | NC/IFault | No Connect (NC). In software mode, this pin is a no connect. Instead, tie this pin to GND. Open-Circuit Fault Alert (IFault). In hardware mode, this pin acts as an open-circuit fault alert pin. It is asserted low when an open-circuit error is detected. This pin is an open-drain output and must be connected to a pull-up resistor. |
| 33 (EPAD) | Exposed paddle | The exposed paddle is tied to GND. |

TYPICAL PERFORMANCE CHARACTERISTICS

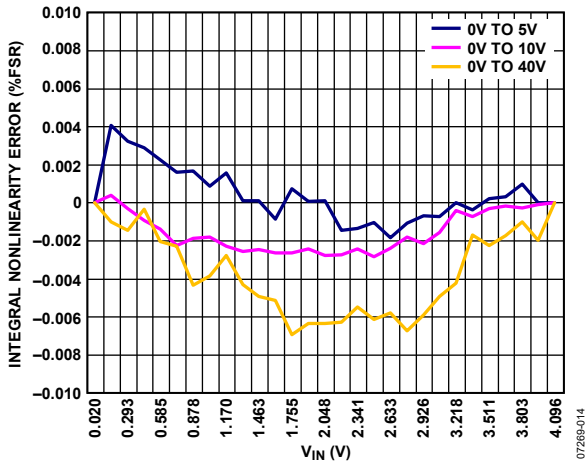

Figure 5. Integral Nonlinearity Error vs. V_{IN}

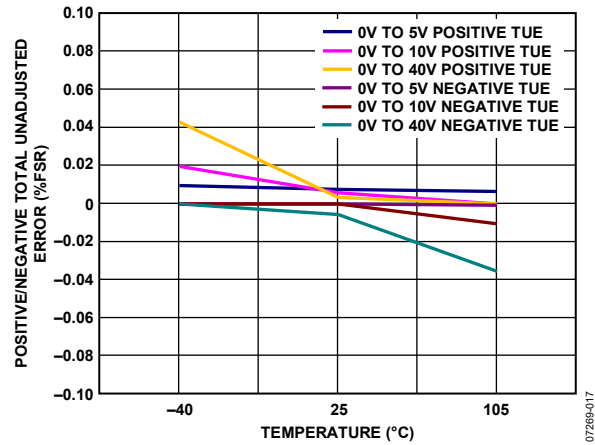

Figure 8. Total Unadjusted Error vs. Temperature

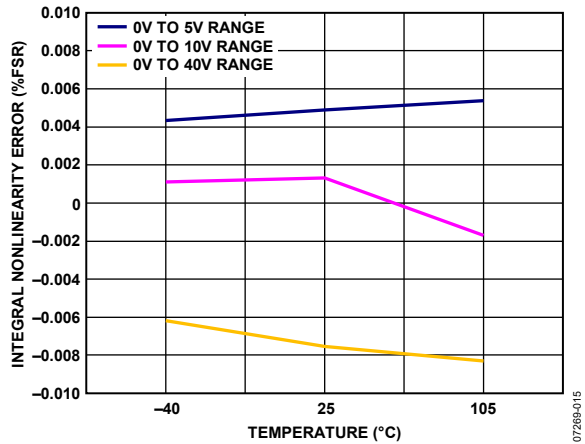

Figure 6. Integral Nonlinearity Error vs. Temperature

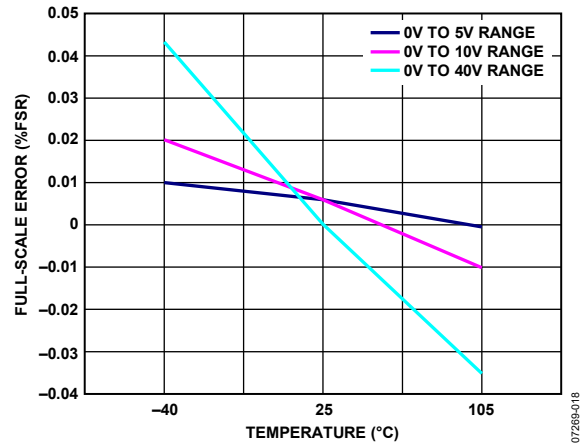

Figure 9. Full-Scale Error vs. Temperature

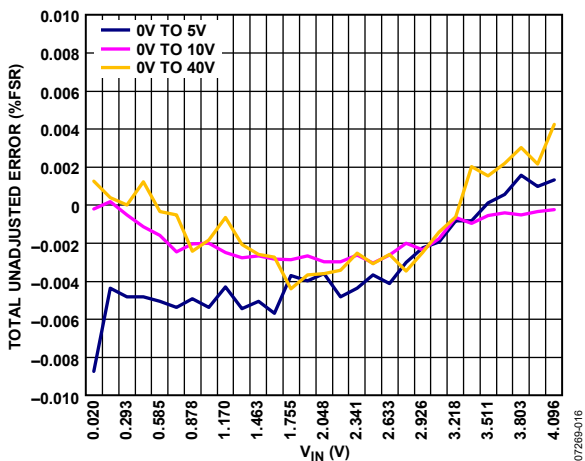

Figure 7. Total Unadjusted Error vs. V_{IN}

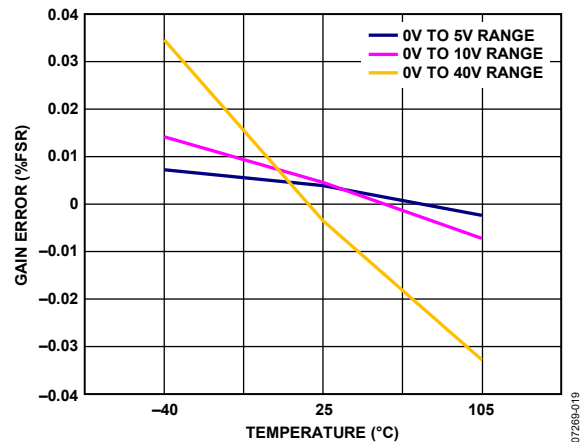

Figure 10. Gain Error vs. Temperature

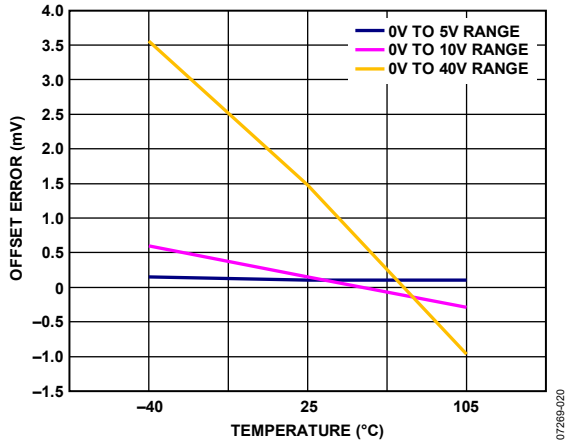

Figure 11. Offset Error vs. Temperature

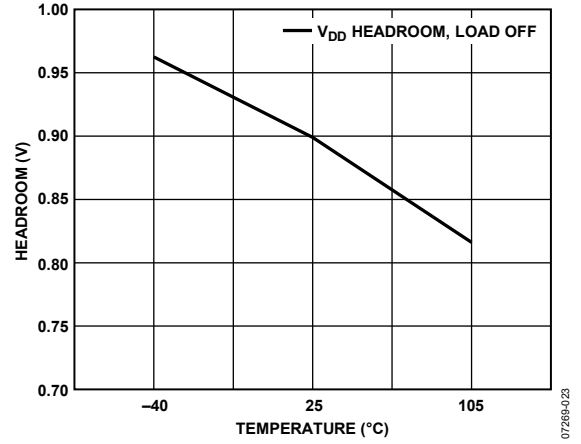

Figure 14. AVDD Headroom, 0V to 10V Range, Output Set to 10V, Load Off

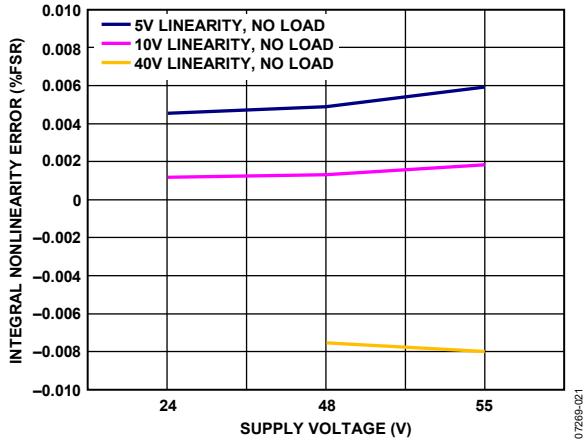

Figure 12. INL Error vs. Supply Voltage

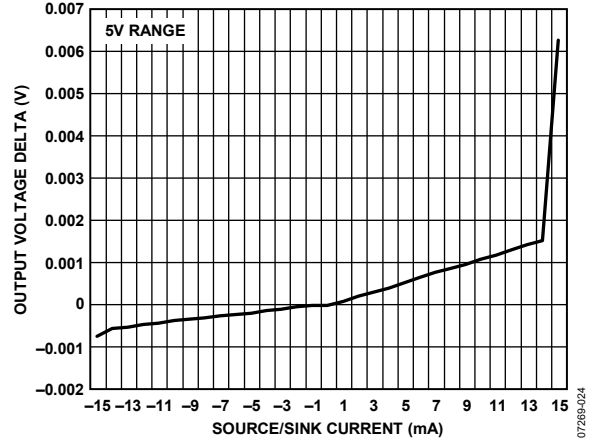

Figure 15. Source and Sink Capability of Output Amplifier

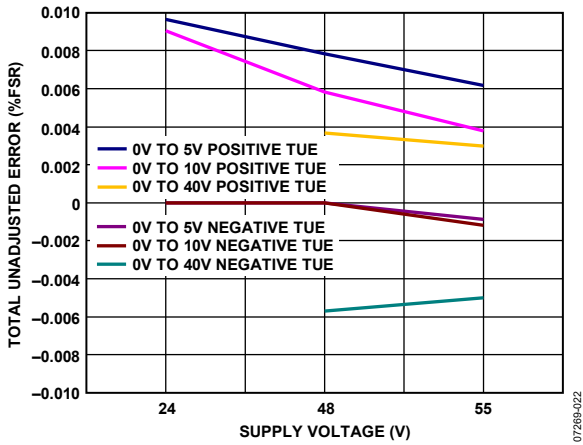

Figure 13. Total Unadjusted Error vs. Supply Voltage

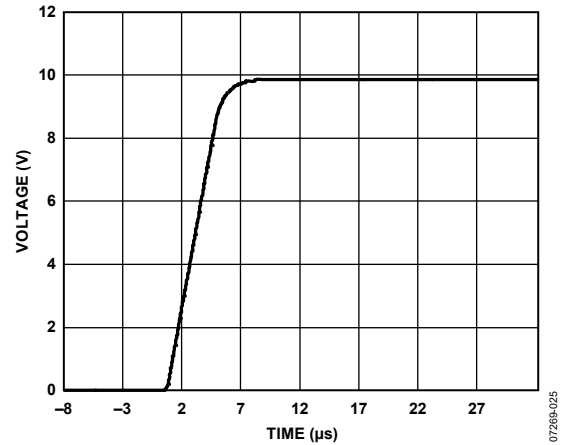

Figure 16. Full-Scale Positive Step, 10V Range

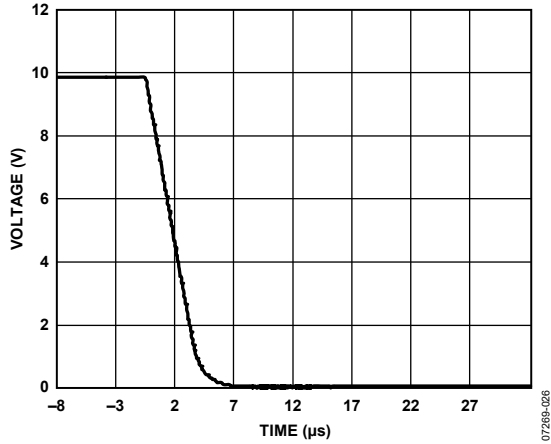

Figure 17. Full-Scale Negative Step, 10 V Range

07268-026

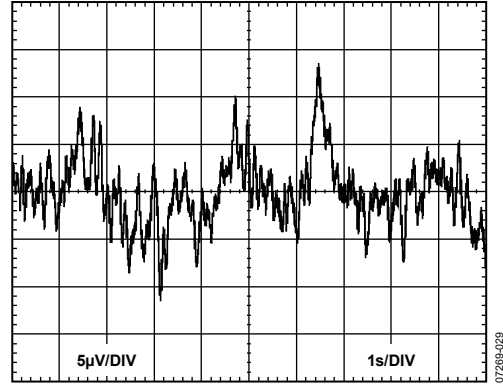

Figure 20. Peak-to-Peak Noise (0.1 Hz to 10 Hz Bandwidth)

07268-028

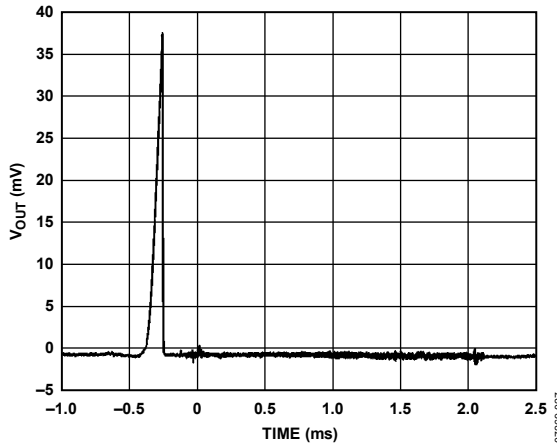

Figure 18. V_{OUT} vs. Time on Power-Up, Load = $2\text{ k}\Omega \parallel 200\text{ pF}$

07268-027

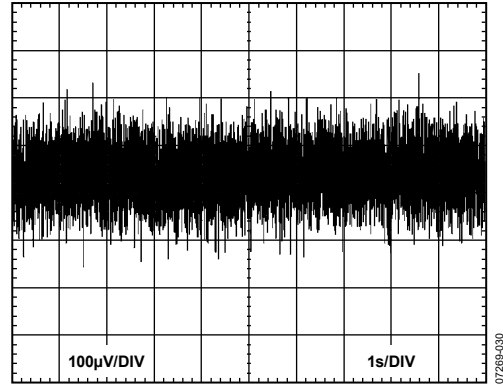

Figure 21. Peak-to-Peak Noise (100 kHz Bandwidth)

07268-030

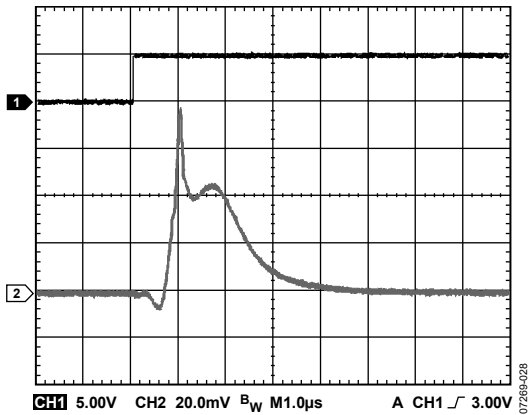

Figure 19. V_{OUT} Enable Glitch, Load = $2\text{ k}\Omega \parallel 1\text{ nF}$

07268-028

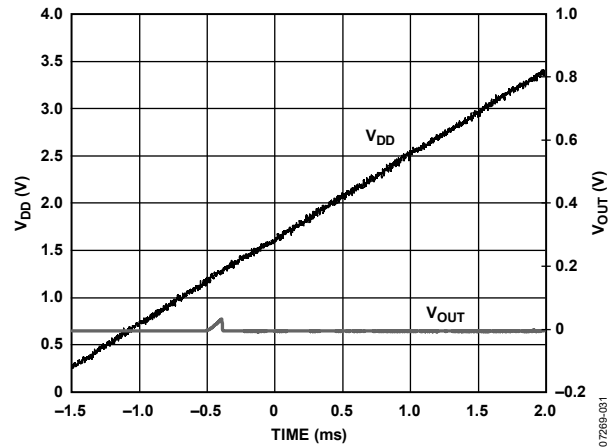

Figure 22. V_{DD} and V_{OUT} vs. Time on Power-Up

07268-031

CURRENT OUTPUT

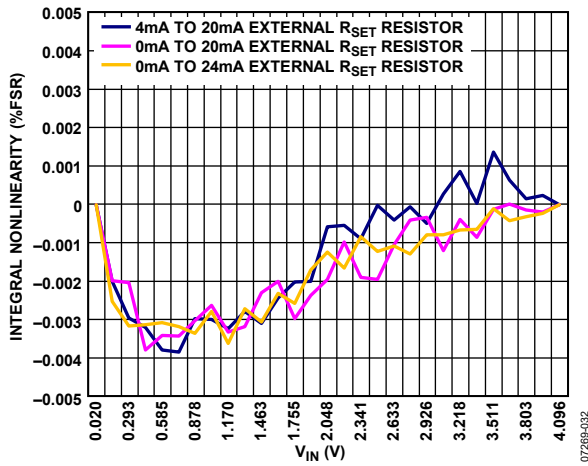

Figure 23. Integral Nonlinearity Error vs. V_{IN} , External R_{SET} Resistor

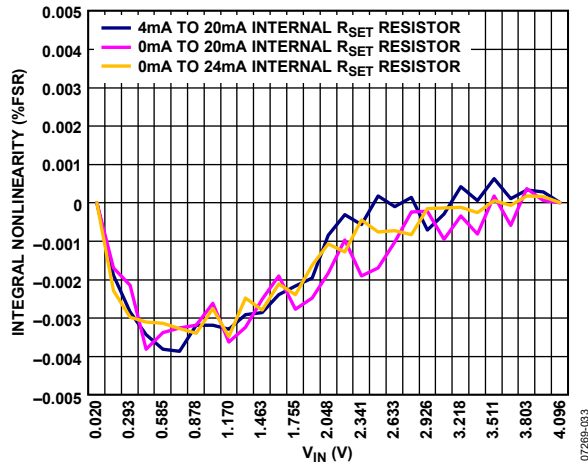

Figure 24. Integral Nonlinearity Error vs. V_{IN} , Internal R_{SET} Resistor

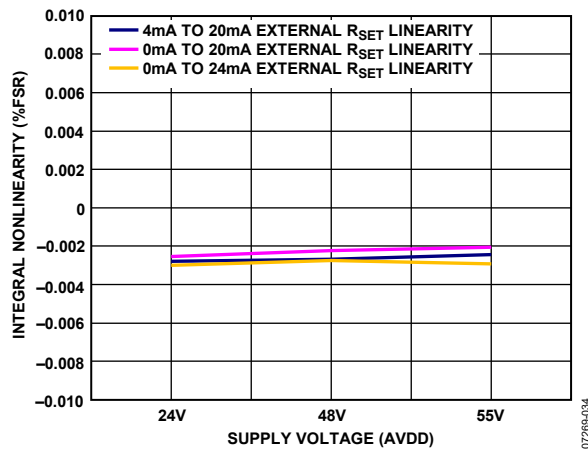

Figure 25. Integral Nonlinearity Current Mode, External R_{SET} Sense Resistor

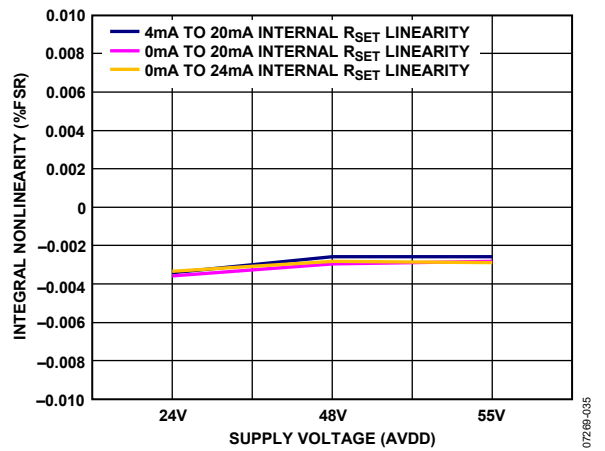

Figure 26. Integral Nonlinearity Current Mode, Internal R_{SET} Sense Resistor

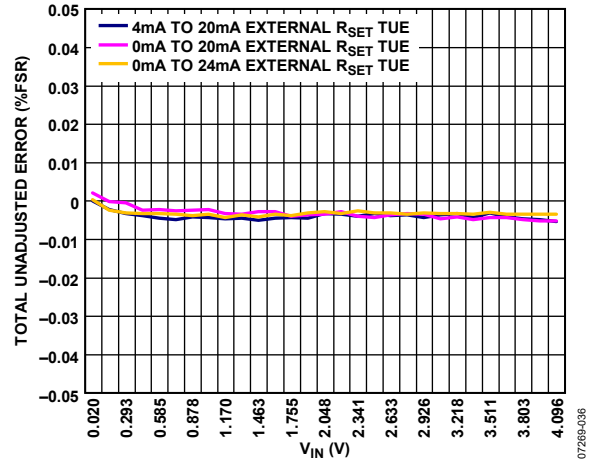

Figure 27. Total Unadjusted Error vs. V_{IN} , External R_{SET} Resistor

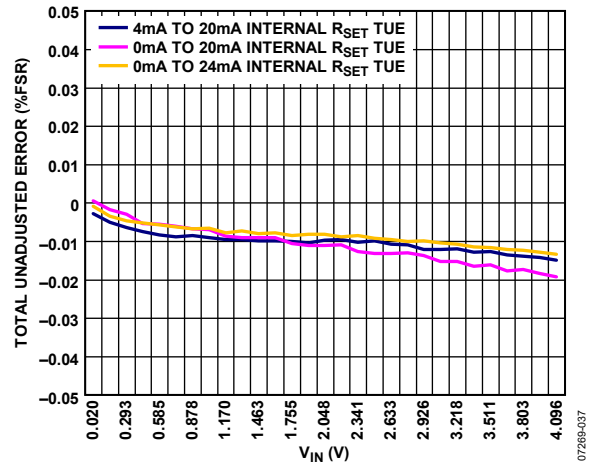

Figure 28. Total Unadjusted Error vs. V_{IN} , Internal R_{SET} Resistor

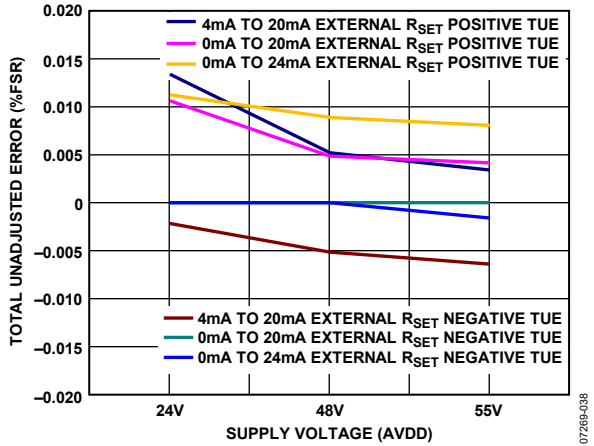

Figure 29. Total Unadjusted Error Current Mode, External R_{SET} Sense Resistor

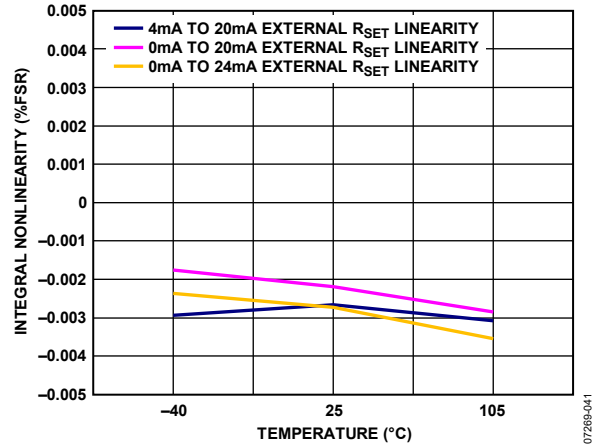

Figure 32. Integral Nonlinearity Error vs. Temperature, External R_{SET} Sense Resistor

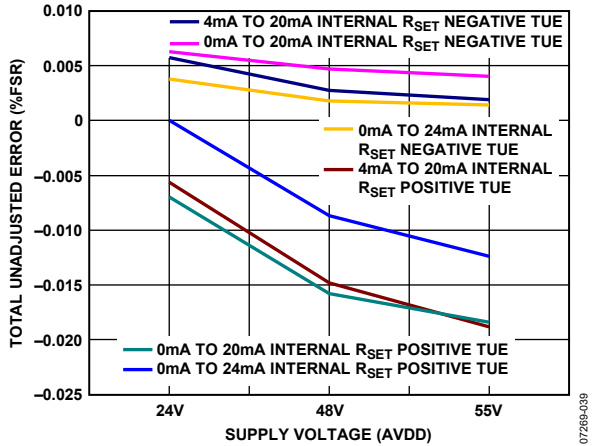

Figure 30. Total Unadjusted Error Current Mode, Internal R_{SET} Sense Resistor

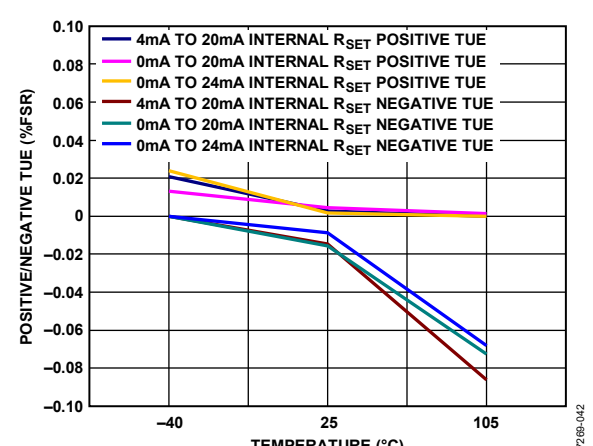

Figure 33. Total Unadjusted Error vs. Temperature, Internal R_{SET} Sense Resistor

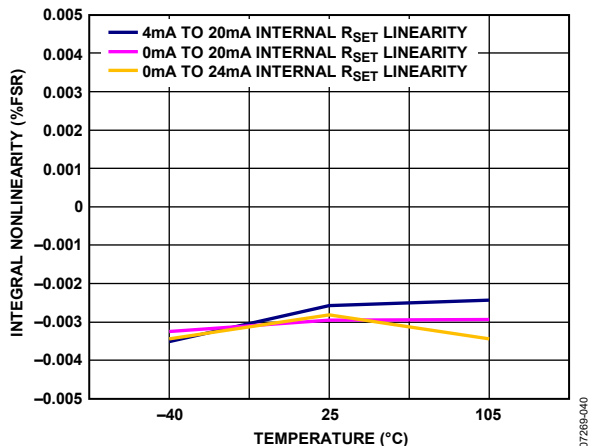

Figure 31. Integral Nonlinearity Error vs. Temperature, Internal R_{SET} Sense Resistor

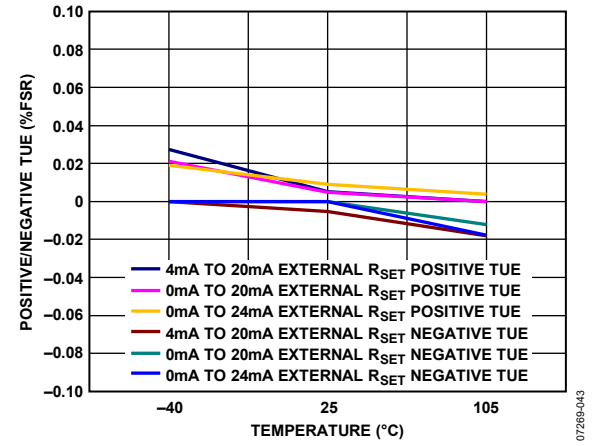

Figure 34. Total Unadjusted Error vs. Temperature, External R_{SET} Sense Resistor

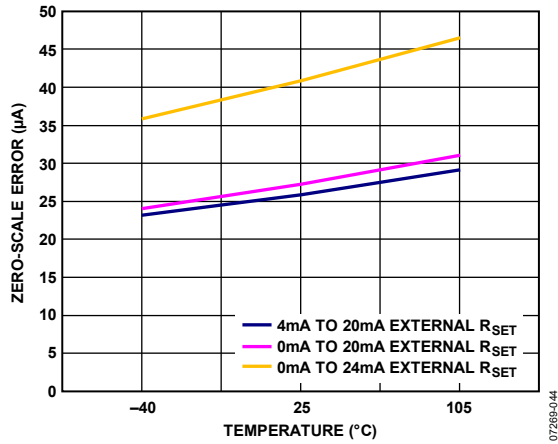

Figure 35. Zero-Scale Error vs. Temperature, External R_{SET} Sense Resistor

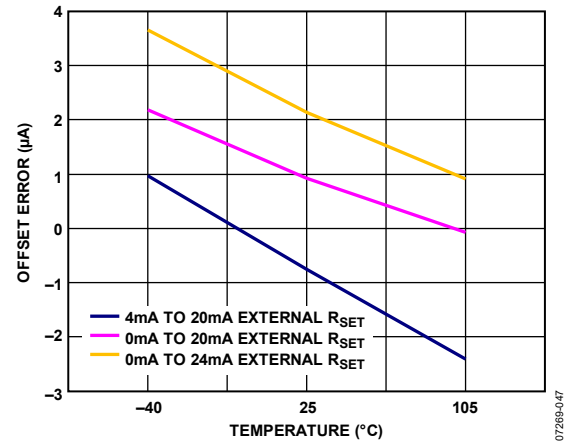

Figure 38. Offset Error vs. Temperature, External R_{SET} Sense Resistor

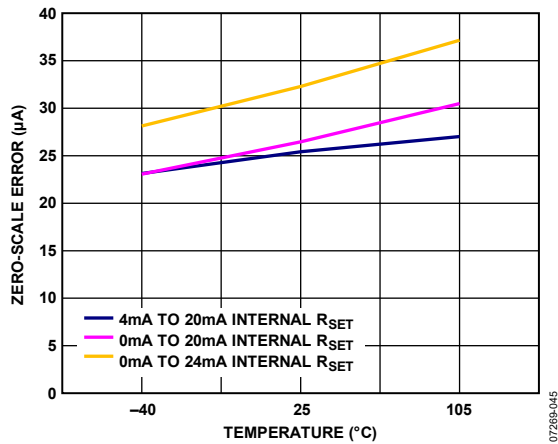

Figure 36. Zero-Scale Error vs. Temperature, Internal R_{SET} Sense Resistor

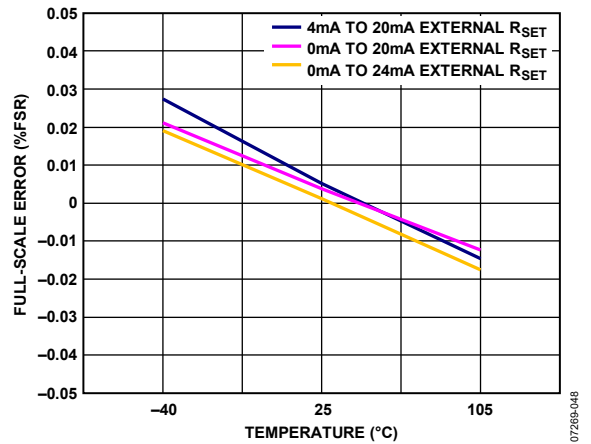

Figure 39. Full-Scale Error vs. Temperature, External R_{SET} Sense Resistor

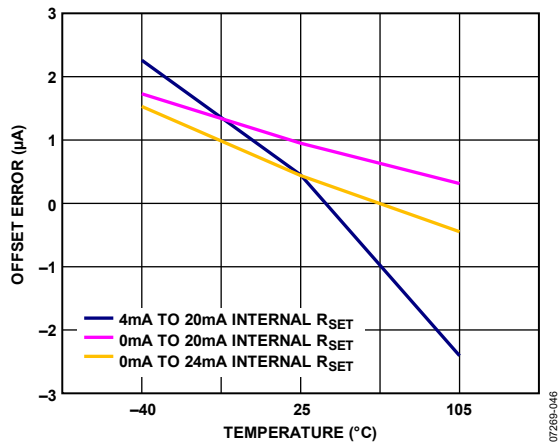

Figure 37. Offset Error vs. Temperature, Internal R_{SET} Sense Resistor

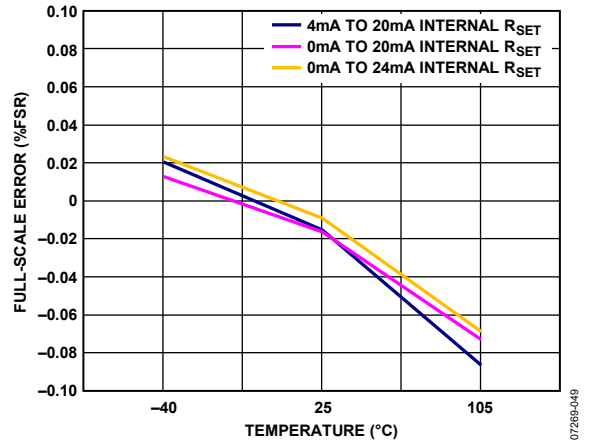

Figure 40. Full-Scale Error vs. Temperature, Internal R_{SET} Sense Resistor

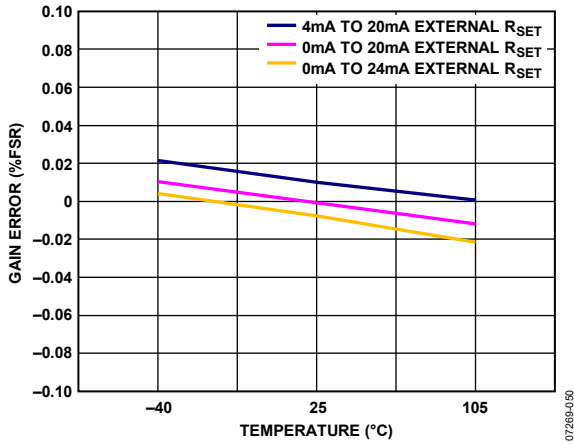

Figure 41. Gain Error vs. Temperature, External R_{SET} Sense Resistor

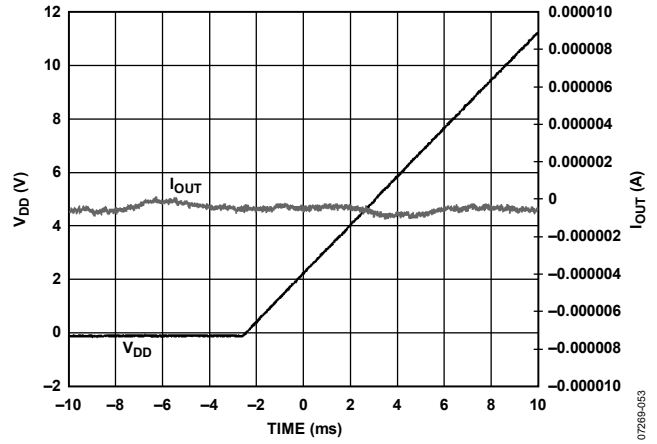

Figure 44. Output Current vs. Time on V_{DD} Power-Up

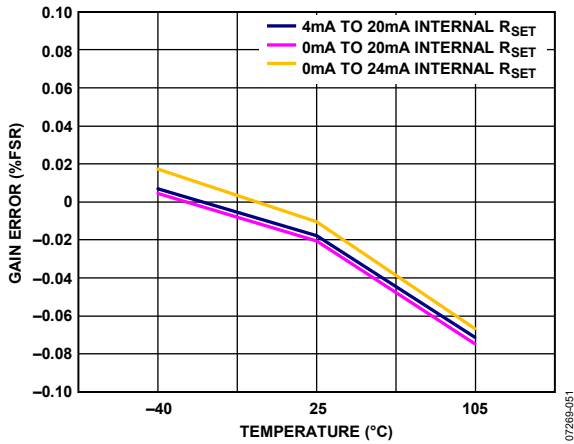

Figure 42. Gain Error vs. Temperature, Internal R_{SET} Sense Resistor

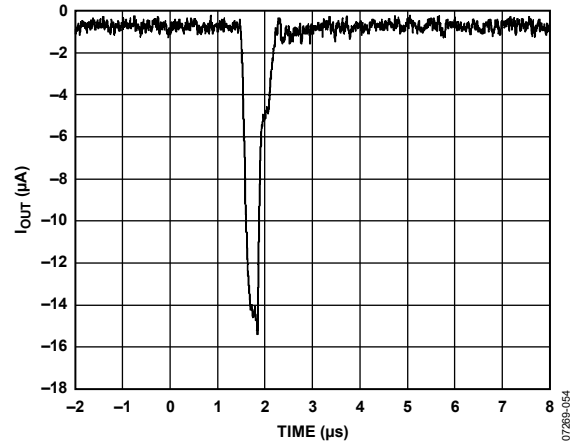

Figure 45. Output Current vs. Time on Output Enable, 0 mA to 20 mA Range

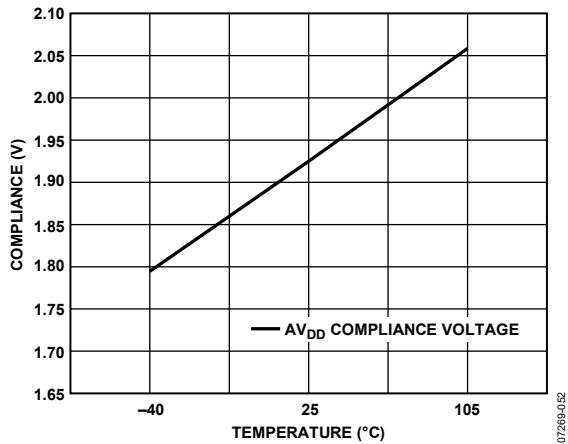

Figure 43. Output Compliance vs. Temperature
Tested When I_{OUT} = 10.8 mA, 0 mA to 24 mA Range Selected

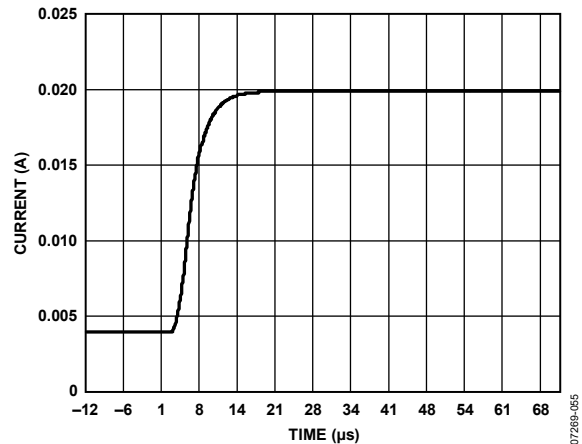

Figure 46. 4 mA to 20 mA Output Current Step

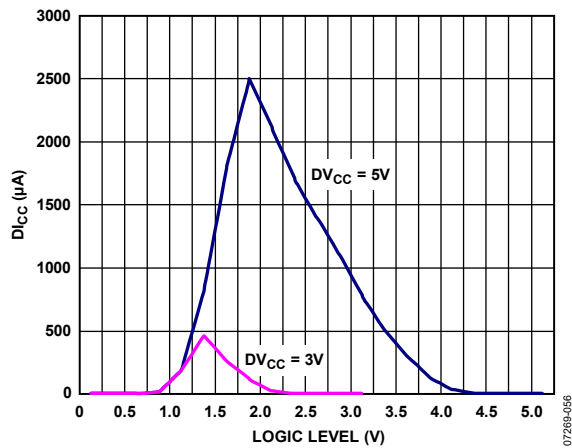

Figure 47. D_{ICC} vs. Logic Input Voltage

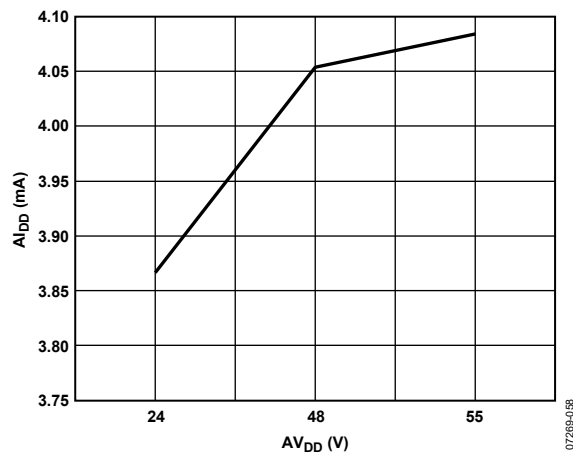

Figure 49. A_{IDD} vs. A_{VDD} , $I_{OUT} = 0$ mA

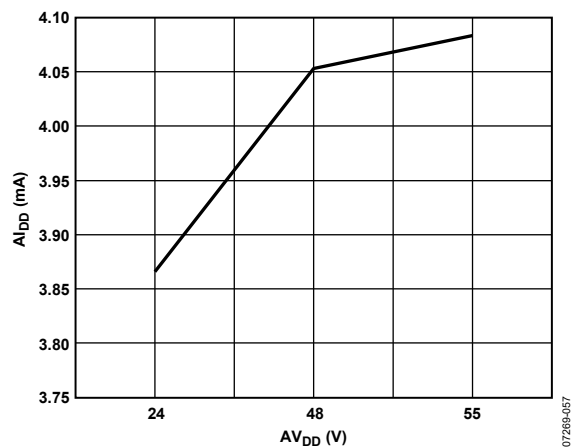

Figure 48. A_{IDD} vs. A_{VDD} , $V_{OUT} = 0$ V

TERMINOLOGY

Total Unadjusted Error (TUE)

TUE is a measure of the output error taking all the various errors into account: INL error, offset error, gain error, and output drift over supplies, temperature, and time. TUE is expressed as a percentage of full-scale range (% FSR).

Relative Accuracy or Integral Nonlinearity (INL)

INL is a measure of the maximum deviation, in % FSR, from a straight line passing through the endpoints of the output driver transfer function. A typical INL vs. input voltage plot is shown in Figure 5.

Full-Scale Error

Full-scale error is the deviation of the actual full-scale analog output from the ideal full-scale output. Full-scale error is expressed as a percentage of full-scale range (% FSR).

Full-Scale TC

Full-scale TC is a measure of the change in the full-scale error with a change in temperature. It is expressed in ppm FSR/°C.

Gain Error

Gain error is a measure of the span error of the output. It is the deviation in slope of the output transfer characteristic from the ideal expressed in % FSR. A plot of gain error vs. temperature is shown in Figure 10.

Gain Error TC

Gain error TC is a measure of the change in gain error with changes in temperature. Gain error TC is expressed in ppm FSR/°C.

Zero-Scale Error

Zero-scale error is the deviation of the actual zero-scale analog output from the ideal zero-scale output. Zero-scale error is expressed in millivolts (mV).

Zero-Scale TC

Zero-scale TC is a measure of the change in zero-scale error with a change in temperature. Zero-scale error TC is expressed in ppm FSR/°C.

Offset Error

Offset error is a measurement of the difference between the actual VOUT and the ideal VOUT expressed in millivolts (mV) in the linear region of the transfer function. It can be negative or positive.

Output Voltage Settling Time

Output voltage settling time is the amount of time it takes for the output to settle to a specified level for a half-scale input change.

Slew Rate

The slew rate of a device is a limitation in the rate of change of the output voltage. The output slewing speed is usually limited by the slew rate of the amplifier used at its output. Slew rate is measured from 10% to 90% of the output signal and is expressed in V/μs.

Current Loop Voltage Compliance

Current loop voltage compliance is the maximum voltage at the IOOUT pin for which the output current is equal to the programmed value.

Power-On Glitch Energy

Power-on glitch energy is the impulse injected into the analog output when the [AD5751](#) is powered on. It is specified as the area of the glitch in nV-sec.

Power Supply Rejection Ratio (PSRR)

PSRR indicates how the output is affected by changes in the power supply voltage.

THEORY OF OPERATION

The **AD5751** is a single-channel, low cost, precision, voltage/current output driver with hardware or software programmable output ranges. The software ranges are configured via an SPI-/MICROWIRE-compatible serial interface. The hardware ranges are programmed using the range pins (R0 to R3). The analog input to the **AD5751** is provided from a low voltage, single-supply DAC (0 V to 4.096 V), which is internally conditioned to provide the desired output current/voltage range.

The output current range is programmable across three ranges: 0 mA to 20 mA, 0 mA to 24 mA, or 4 mA to 20 mA. The voltage output is provided from a separate pin that can be configured to provide 0 V to 5 V, 0 V to 10 V, and 0 V to 40 V output ranges. An overrange of 20% is available on the 5 V and 10 V output voltage ranges, and of 10% on the 0 V to 40 V range. The VOUT and IOUT pins can be connected together. An overrange of 2% is available on the 0 mA to 20 mA, 0 mA to 24 mA, and 4 mA to 20 mA current ranges. The current and voltage outputs are available on separate pins. Only one output can be enabled at one time. The output range is selected by program-

ming the R3 to R0 bits in the control register (see Table 7 and Table 8).

Figure 50 and Figure 51 show a typical configuration of **AD5751** in software mode and in hardware mode, respectively, in an output module system. The HW SELECT pin chooses whether the part is configured in software or hardware mode. The analog input to the **AD5751** is provided from a low voltage, single-supply DAC such as the AD506x or AD566x, which can provide an output range of 0 V to 4.096 V. The supply and reference for the DAC, as well as the reference for the **AD5751**, can be supplied from a reference such as the **ADR392**. The **AD5751** can operate with a single supply up to 55 V.

SOFTWARE MODE

In current mode, software-selectable output ranges include 0 mA to 20 mA, 0 mA to 24 mA, or 4 mA to 20 mA.

In voltage mode, software-selectable output ranges include 0 V to 5 V, 0 V to 10 V, 0 V to 40 V.

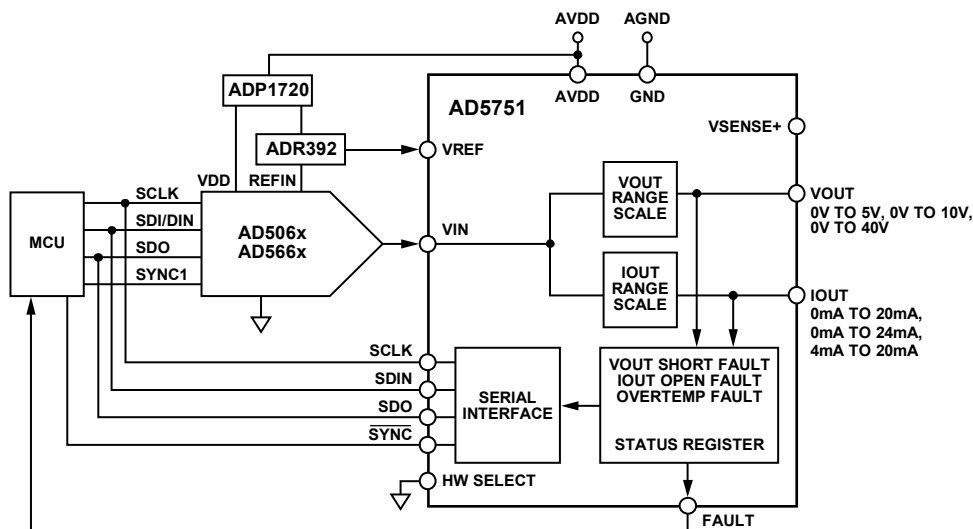

Figure 50. Typical System Configuration in Software Mode (Pull-Up Resistors Not Shown for Open-Drain Outputs)

07289-006

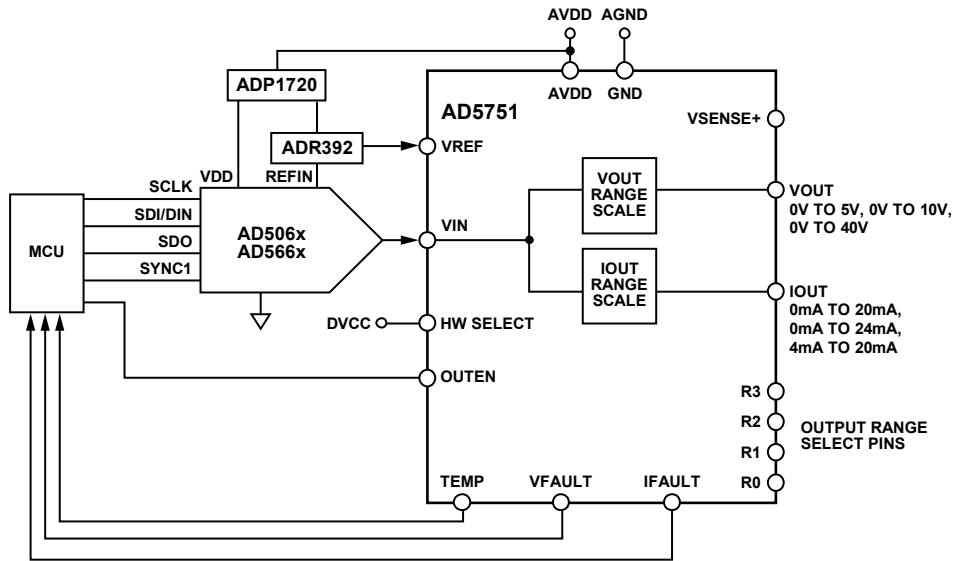

Figure 51. Typical System Configuration in Hardware Mode Using Internal DAC Reference (Pull-Up Resistors Not Shown for Open-Drain Outputs)

Table 6. Suggested Parts for Use with the AD5751

| DAC | Reference | Power | Resolution/Accuracy | Description |
|---------------|---------------------|----------------------|---------------------|---|
| AD5660 | Internal | ADP1720 ¹ | 16-bit/12-bit | Mid end system, single channel, internal reference |
| AD5664R | Internal | N/A | 16-bit/12-bit | Mid end system, quad channel, internal reference |
| AD5668 | Internal | N/A | 16-bit/12-bit | Mid end system, octal channel, internal reference |
| AD5060 | ADR434 | ADP1720 | 16-bit/16-bit | High end system, single channel, external reference |
| AD5064/AD5066 | ADR434 | N/A | 16-bit/16-bit | High end system, quad channel, external reference |
| AD5662 | ADR392 ² | ADR392 ² | 16-bit/12-bit | Mid end system, single channel, external reference |
| AD5664 | ADR392 ² | N/A | 16-bit/12-bit | Mid end system, quad channel, external reference |

¹ ADP1720 input range up to 28 V.

² ADR392 input range up to 15 V.

CURRENT OUTPUT ARCHITECTURE

The voltage input from the analog input VIN core (0 V to 4.096 V) is either converted to a current (see Figure 52), which is then mirrored to the supply rail so that the application simply sees a current source output with respect to an internal reference voltage, or it is buffered and scaled to output a software-selectable unipolar voltage range (see Figure 53). The reference is used to provide internal offsets for range and gain scaling. The selectable output range is programmable through the digital interface (software mode) or via the range pins (R0 to R3) (hardware mode).

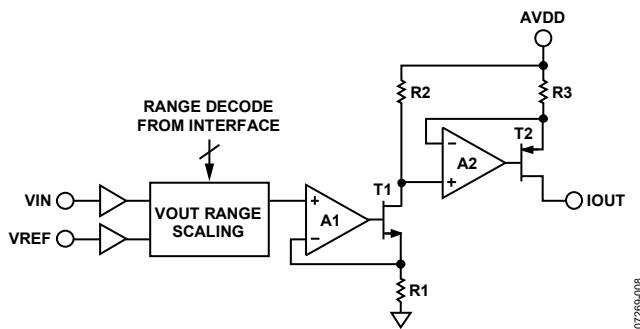

Figure 52. Current Output Configuration

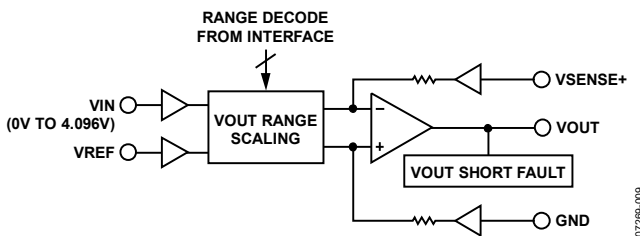

Figure 53. Voltage Output

DRIVING INDUCTIVE LOADS

When driving inductive or poorly defined loads, connect a 0.01 μF capacitor between IOUT and GND. This ensures stability with loads beyond 50 mH. There is no maximum capacitance limit. The capacitive component of the load may cause slower settling.

Voltage Output Amplifier

The voltage output amplifier is capable of driving a load of 1 k Ω (for 0 V to 5 V and 0 V to 10 V ranges) and a load of 5 k Ω (for 0 V to 40 V range) and capacitive loads up to 2 μF (with an external compensation capacitor on the COMP1 and COMP2 pins). The source and sink capabilities of the output amplifier can be seen in Figure 15. The slew rate is 2 V/ μs .

Internal to the device, there is a 2.5 M Ω resistor connected between VOUT and VSENSE+. If a fault condition occurs, these resistors act to protect the AD5751 by ensuring that the amplifier loop is closed so that the part does not enter into an open-loop condition.

The current and voltage are output on separate pins and cannot be output simultaneously. This allows the user to tie both the

current and voltage output pins together and configure the end system as a single-channel output.

Driving Large Capacitive Loads

The voltage output amplifier is capable of driving capacitive loads of up to 1 μF with the addition of a nonpolarized compensation capacitor between the COMP1 and COMP2 pins.

Without the compensation capacitor, up to 20 nF capacitive loads can be driven. Care should be taken to choose an appropriate value for the C_{COMP} capacitor. This capacitor, while allowing the AD5751 to drive higher capacitive loads and reduce overshoot, increases the settling time of the part and therefore affects the bandwidth of the system. Considered values of this capacitor should be in the range of 0 nF to 4 nF depending on the trade-off required between settling time, overshoot, and bandwidth.

POWER-ON STATE OF THE AD5751

On power-up, the AD5751 senses whether hardware or software mode is loaded and sets the power-up conditions accordingly.

In software SPI mode, the power-up state of the output is dependent on the state of the CLEAR pin. If the CLEAR pin is pulled high, the part powers up, driving an active 0 V on the output. If the CLEAR pin is pulled low, the part powers up with the voltage output channel in tristate mode. In both cases, the current output channel powers up in the tristate condition (0 mA). This allows the voltage and current outputs to be connected together if desired.

To put the part into normal operation, the user must set the OUTEN bit in the control register to enable the output and, in the same write, set the output range configuration using the R3 to R0 range bits. If the CLEAR pin is still high (active) during this write, the part automatically clears to its normal clear state as defined by the programmed range and by the CLRSEL pin or the CLRSEL bit (see the Asynchronous Clear (CLEAR) section for more details). The CLEAR pin must be taken low to operate the part in normal mode.

The CLEAR pin is typically driven directly from a microcontroller. In cases where the power supply for the AD5751 supply is independent of the microcontroller power supply, the user can connect a weak pull-up resistor to DVCC or a pull-down resistor to ground to ensure that the correct power-up condition is achieved independent of the microcontroller. A 10 k Ω pull-up/pull-down resistor on the CLEAR pin should be sufficient for most applications.

If hardware mode is selected, the part powers up to the conditions defined by the R3 to R0 range bits and the status of the OUTEN or CLEAR pin. It is recommended to keep the output disabled when powering up the part in hardware mode.

DEFAULT REGISTERS AT POWER-ON

The AD5751 power-on-reset circuit ensures that all registers are loaded with zero code.

In software SPI mode, the part powers up with all outputs disabled (OUTEN bit = 0). The user must set the OUTEN bit in the control register to enable the output and, in the same write, set the output range configuration using the R3 to R0 bits.

If hardware mode is selected, the part powers up to the conditions defined by the R3 to R0 bits and the status of the OUTEN pin. It is recommended to keep the output disabled when powering up the part in hardware mode.

RESET FUNCTION

In software mode, the part can be reset using the $\overline{\text{RESET}}$ pin (active low) or the reset bit (reset = 1). A reset disables both the current and voltage outputs to their power-on condition. The user must write to the OUTEN bit to enable the output and, in the same write, set the output range configuration. The $\overline{\text{RESET}}$ pin is a level sensitive input; the part stays in reset mode as long as the $\overline{\text{RESET}}$ pin is low. The reset bit clears to 0 following a reset command to the control register.

In hardware mode, there is no reset. If using the part in hardware mode, the $\overline{\text{RESET}}$ pin should be tied high.

OUTEN

In software mode, the output can be enabled or disabled using the OUTEN bit in the control register. When the output is

disabled, both the current and voltage channels go into tristate. The user must set the OUTEN bit to enable the output and simultaneously set the output range configuration.

In hardware mode, the output can be enabled or disabled using the OUTEN pin. When the output is disabled, both the current and voltage channels go into tristate. The user must write to the OUTEN pin to enable the output. It is recommended that the output be disabled when changing the ranges.

SOFTWARE CONTROL

Software control is enabled by connecting the HW SELECT pin to ground. In software mode, the AD5751 is controlled over a versatile 3-wire serial interface that operates at clock rates up to 50 MHz. It is compatible with SPI, QSPI™, MICROWIRE, and DSP standards.

Input Shift Register

The input shift register is 16 bits wide. Data is loaded into the device MSB first as a 16-bit word under the control of a serial clock input, SCLK. Data is clocked in on the falling edge of SCLK. The input shift register consists of 16 control bits, as shown in Table 7. The timing diagram for this write operation is shown in Figure 2. The first three bits of the input shift register are used to set the hardware address of the AD5751 device on the printed circuit board (PCB). Up to eight devices can be addressed per board.

Bit D11, Bit D1, and Bit D0 must always be set to 0 during any write sequence.

Table 7. Input Shift Register Contents for a Write Operation—Control Register

| MSB | | | | | | | | | | | | | | LSB | |
|-----|-----|-----|-----|-----|-----|----|----|----|--------|-------|-------|------|-------|-----|----|
| D15 | D14 | D13 | D12 | D11 | D10 | D9 | D8 | D7 | D6 | D5 | D4 | D3 | D2 | D1 | D0 |
| A2 | A1 | A0 | R/W | 0 | R3 | R2 | R1 | R0 | CLRSEL | OUTEN | Clear | RSET | Reset | 0 | 0 |

Table 8. Input Shift Register Descriptions for Control Register

| Bit | Description | | | |
|------------|---|----|----|--|
| A2, A1, A0 | Used in association with the AD2, AD1, and AD0 external pins to determine which part is being addressed by the system controller. | | | |
| | A2 | A1 | A0 | Function |
| | 0 | 0 | 0 | Addresses part with Pin AD2 = 0, Pin AD1 = 0, Pin AD0 = 0. |
| | 0 | 0 | 1 | Addresses part with Pin AD2 = 0, Pin AD1 = 0, Pin AD0 = 1. |
| | 0 | 1 | 0 | Addresses part with Pin AD2 = 0, Pin AD1 = 1, Pin AD0 = 0. |
| | 0 | 1 | 1 | Addresses part with Pin AD2 = 0, Pin AD1 = 1, Pin AD0 = 1. |
| | 1 | 0 | 0 | Addresses part with Pin AD2 = 1, Pin AD1 = 0, Pin AD0 = 0. |
| | 1 | 0 | 1 | Addresses part with Pin AD2 = 1, Pin AD1 = 0, Pin AD0 = 1. |
| | 1 | 1 | 0 | Addresses part with Pin AD2 = 1, Pin AD1 = 1, Pin AD0 = 0. |
| | 1 | 1 | 1 | Addresses part with Pin AD2 = 1, Pin AD1 = 1, Pin AD0 = 1. |
| R/W | Indicates a read from or a write to the addressed register. | | | |

| Bit | Description | | | | | |
|----------------|--|--|-----------|-----------|-----------|--|
| R3, R2, R1, R0 | Selects the output configuration in conjunction with RSET. | | | | | |
| | RSET | R3 | R2 | R1 | R0 | Output Configuration |
| | 0 | 0 | 0 | 0 | 0 | 4 mA to 20 mA (external 15 k Ω current sense resistor). |
| | 0 | 0 | 0 | 0 | 1 | 0 mA to 20 mA (external 15 k Ω current sense resistor). |
| | 0 | 0 | 0 | 1 | 0 | 0 mA to 24 mA (external 15 k Ω current sense resistor). |
| | 0 | 0 | 0 | 1 | 1 | Unused command. Do not program. |
| | 0 | 0 | 1 | 0 | 0 | Unused command. Do not program. |
| | 0 | 0 | 1 | 0 | 1 | 0 V to 5 V. |
| | 0 | 0 | 1 | 1 | 0 | 0 V to 10 V. |
| | 0 | 0 | 1 | 1 | 1 | Unused command. Do not program. |
| | 0 | 1 | 0 | 0 | 0 | Unused command. Do not program. |
| | 0 | 1 | 0 | 0 | 1 | 0 V to 6.0 V (20% overrange). |
| | 0 | 1 | 0 | 1 | 0 | 0 V to 12.0 V (20% overrange). |
| | 0 | 1 | 0 | 1 | 1 | Unused command. Do not program. |
| | 0 | 1 | 1 | 0 | 0 | Unused command. Do not program. |
| | 0 | 1 | 1 | 0 | 1 | Unused command. Do not program. |
| | 0 | 1 | 1 | 1 | 0 | 0 V to 40 V. |
| | 0 | 1 | 1 | 1 | 1 | 0 V to 44 V. |
| | 1 | 0 | 0 | 0 | 0 | 4 mA to 20 mA (internal current sense resistor). |
| | 1 | 0 | 0 | 0 | 1 | 0 mA to 20 mA (internal current sense resistor). |
| | 1 | 0 | 0 | 1 | 0 | 0 mA to 24 mA (internal current sense resistor). |
| | 1 | 0 | 0 | 1 | 1 | Unused command. Do not program. |
| | 1 | 0 | 1 | 0 | 0 | Unused command. Do not program. |
| | 1 | 0 | 1 | 0 | 1 | 0 V to 5 V. |
| | 1 | 0 | 1 | 1 | 0 | 0 V to 10 V. |
| | 1 | 0 | 1 | 1 | 1 | Unused command. Do not program. |
| | 1 | 1 | 0 | 0 | 0 | Unused command. Do not program. |
| | 1 | 1 | 0 | 0 | 1 | 0 V to 6.0 V (20% overrange). |
| | 1 | 1 | 0 | 1 | 0 | 0 V to 12.0 V (20% overrange). |
| | 1 | 1 | 0 | 1 | 1 | Unused command. Do not program. |
| | 1 | 1 | 1 | 0 | 0 | Unused command. Do not program. |
| | 1 | 1 | 1 | 0 | 1 | 3.92 mA to 20.4 mA (internal current sense resistor). |
| | 1 | 1 | 1 | 1 | 0 | 0 mA to 20.4 mA (internal current sense resistor). |
| | 1 | 1 | 1 | 1 | 1 | 0 mA to 24.5 mA (internal current sense resistor). |
| CLRSEL | Sets clear mode to zero scale or midscale. See the Asynchronous Clear (CLEAR) section. | | | | | |
| | CLRSEL | Function | | | | |
| | 0 | Clear to 0 V. | | | | |
| | 1 | Clear to midscale in unipolar mode; clear to zero scale in bipolar mode. | | | | |
| OUTEN | Output enable bit. This bit must be set to 1 to enable the outputs. | | | | | |
| Clear | Software clear bit; active high. | | | | | |
| RSET | Select internal/external current sense resistor. | | | | | |
| | RSET | Function | | | | |
| | 1 | Select internal current sense resistor; used with R3 to R0 bits to select range. | | | | |
| | 0 | Select external current sense resistor; used with R3 to R0 bits to select range. | | | | |
| Reset | Resets the part to its power-on state. | | | | | |

Readback Operation

Readback mode is activated by selecting the correct device address (A2, A1, A0) and then setting the R/W bit to 1. By default, the SDO pin is disabled. After having addressed the [AD5751](#) for a read operation, setting R/W to 1 enables the SDO pin and SDO data is clocked out on the 5th rising edge of SCLK. After the data has been clocked out on SDO, a rising edge on $\overline{\text{SYNC}}$ disables (tristate) the SDO pin again. Status register data (see Table 9) and control register data are both available during the same read cycle.

The status bits comprise four read-only bits. They are used to notify the user of specific fault conditions that occur, such as an open circuit or short circuit on the output, overtemperature error, or an interface error. If any of these fault conditions occur, a hardware FAULT is also asserted low, which can be used as a hardware interrupt to the controller.

See the Detailed Description of Features section for a full explanation of fault conditions.

HARDWARE CONTROL

Hardware control is enabled by connecting the HW SELECT pin to DVCC. In this mode, the R3, R2, R1, and R0 pins, in conjunction with the RSET pin, are used to configure the output range, as per Table 8.

In hardware mode, there is no status register. The fault conditions (open circuit, short circuit, and overtemperature) are available on Pin IFAULT, Pin VFAULT, and Pin TEMP. If any one of these fault conditions is set, a low is asserted on the specific fault pin. IFAULT, VFAULT, and TEMP are open-drain outputs and, therefore, can be connected together to allow the user to generate one interrupt to the system controller to communicate a fault. If hardwired in this way, it is not possible to isolate which fault occurred in the system.

TRANSFER FUNCTION

The [AD5751](#) consists of an internal signal conditioning block that maps the analog input voltage to a programmed output range. The available analog input range is 0 V to 4.096 V.

For all ranges, both current and voltage, the [AD5751](#) implements a straight linear mapping function, where 0 V maps to the lower end of the selected range and 4.096 V maps to the upper end of the selected range.

Table 9. Input Shift Register Contents for a Read Operation—Status Register

| MSB | | | | | | | | | | | | | | LSB | |
|-----|-----|-----|-----|-----|-----|----|----|----|--------|-------|------|-----------|-----------|------------|------------|
| D15 | D14 | D13 | D12 | D11 | D10 | D9 | D8 | D7 | D6 | D5 | D4 | D3 | D2 | D1 | D0 |
| A2 | A1 | A0 | 1 | 0 | R3 | R2 | R1 | R0 | CLRSEL | OUTEN | RSET | PEC error | OVER TEMP | IOUT fault | VOUT fault |

Table 10. Status Bit Options

| Bit | Description |
|------------|--|
| PEC Error | This bit is set if there is an interface error detected by CRC-8 error checking. See the Detailed Description of Features section. |
| OVER TEMP | This bit is set if the AD5751 core temperature exceeds approximately 150°C. |
| IOUT Fault | This bit is set if there is an open circuit on the IOUT pin. |
| VOUT Fault | This bit is set if there is a short circuit on the VOUT pin. |

DETAILED DESCRIPTION OF FEATURES

OUTPUT FAULT ALERT—SOFTWARE MODE

In software mode, the AD5751 is equipped with one FAULT pin; this is an open-drain output allowing several AD5751 devices to be connected together to one pull-up resistor for global fault detection. In software mode, the FAULT pin is forced active low by any one of the following fault scenarios:

- The voltage at IOUT attempts to rise above the compliance range due to an open-loop circuit or insufficient power supply voltage. The internal circuitry that develops the fault output avoids using a comparator with window limits because this requires an actual output error before the fault output becomes active. Instead, the signal is generated when the internal amplifier in the output stage has less than approximately 1 V of remaining drive capability. Thus, the fault output activates slightly before the compliance limit is reached. Because the comparison is made within the feedback loop of the output amplifier, the output accuracy is maintained by its open-loop gain, and an output error does not occur before the fault output becomes active.
- A short is detected on the voltage output pin (VOUT). The short-circuit current is limited to 15 mA.
- An interface error is detected due to the packet error checking failure (PEC). See the Packet Error Checking section.
- The core temperature of the AD5751 exceeds approximately 150°C.

OUTPUT FAULT ALERT—HARDWARE MODE

In hardware mode, the AD5751 is equipped with three fault pins: VFAULT, IFAULT, and TEMP. These are open-drain outputs allowing several AD5751 devices to be connected together to one pull-up resistor for global fault detection. In hardware control mode, these fault pins are forced active by any one of the following fault scenarios:

- An open-circuit is detected. The voltage at IOUT attempts to rise above the compliance range, due to an open-loop circuit or insufficient power supply voltage. The internal circuitry that develops the fault output avoids using a comparator with window limits because this requires an actual output error before the fault output becomes active. Instead, the signal is generated when the internal amplifier in the output stage has less than approximately 1 V of remaining drive capability. Thus, the fault output activates slightly before the compliance limit is reached. Because the comparison is made within the feedback loop of the output amplifier, the output accuracy is maintained by its open-loop gain, and an output error does not occur before the fault output becomes active. If this fault is detected, the IFAULT pin is forced low.

- A short is detected on the voltage output pin. The short-circuit current is limited to 15 mA. If this fault is detected, the VFAULT pin is forced low.
- The core temperature of the AD5751 exceeds approximately 150°C. If this fault is detected, the TEMP pin is forced low.

VOLTAGE OUTPUT SHORT-CIRCUIT PROTECTION

Under normal operation the voltage output sinks and sources up to 12 mA and maintains specified operation. The maximum current that the voltage output delivers is 15 mA; this is the short-circuit current.

ASYNCHRONOUS CLEAR (CLEAR)

CLEAR is an active high clear that allows the voltage output to be cleared to either zero-scale code or midscale code, and is user-selectable via the CLRSEL pin or the CLRSEL bit of the input shift register, as described in Table 8. (The clear select feature is a logical OR function of the CLRSEL pin and the CLRSEL bit). The current loop output clears to the bottom of its programmed range. When the CLEAR signal is returned low, the output returns to its programmed value or to a new programmed value. A clear operation can also be performed via the clear command in the control register.

Table 11. CLRSEL Options

| CLRSEL | Output Clear Value | |
|--------|-------------------------------|--|
| | Unipolar Output Voltage Range | Unipolar Current Output Range |
| 0 | 0 V | Zero-scale; for example: 4 mA on the 4 mA to 20 mA range 0 mA on the 0 mA to 20 mA |
| 1 | Midscale | Midscale; for example: 12 mA on the 4 mA to 20 mA range 10 mA on the 0 mA to 20 mA range |

EXTERNAL CURRENT SETTING RESISTOR

Referring to Figure 1, R_{SET} is an internal sense resistor and is part of the voltage-to-current conversion circuitry. The nominal value of the internal current sense resistor is 15 k Ω . To allow for overrange capability in current mode, the user can also select the internal current sense resistor to be 14.7 k Ω , giving a nominal 2% overrange capability. This feature is available in the 0 mA to 20 mA, 0 mA to 24 mA, and 4 mA to 20 mA current ranges.

The stability of the output current value over temperature is dependent on the stability of the value of R_{SET} . As a method of improving the stability of the output current over temperature, an external low drift resistor can be connected to the REXT1 and REXT2 pins of the AD5751, which can be used instead of the internal resistor. The external resistor is selected via the input shift register. If the external resistor option is not used, the REXT1 and REXT2 pins should be left floating.

PROGRAMMABLE OVERRANGE MODES

The AD5751 contains an overrange mode for most of the available ranges. The overranges are selected by configuring the R3, R1, R1, and R0 bits (or pins) accordingly.

In voltage mode, depending on selected range, the overranges are 10% or 20%, providing programmable output ranges of 0 V to 6 V, 0 V to 12 V, and 0 V to 44 V. The 0 V to 4.096 V analog input remains the same.

In current mode, the overranges are typically 2%. In current mode, the overrange capability is only available on three ranges, 0 mA to 20 mA, 0 mA to 24 mA, and 4 mA to 20 mA. For these ranges, the analog input also remains the same (0 V to 4.096 V).

PACKET ERROR CHECKING

To verify that data has been received correctly in noisy environments, the AD5751 offers the option of error checking based on an 8-bit (CRC-8) cyclic redundancy check. The device controlling the AD5751 should generate an 8-bit frame check sequence using the following polynomial:

$$C(x) = x_8 + x_2 + x_1 + 1$$

This is added to the end of the data-word, and 24 data bits are sent to the AD5751 before taking SYNC high. If the AD5751 receives a 24-bit data frame, it performs the error check when SYNC goes high. If the check is valid, then the data is written to the selected register. If the error check fails, the FAULT pin goes low and Bit D3 of the status register is set. After reading this register, this error flag is cleared automatically and the FAULT pin goes high again.

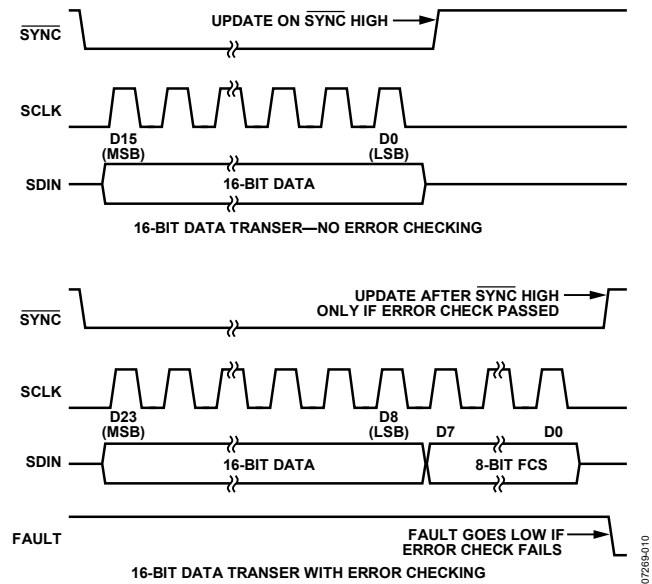

Figure 54. PEC Error Checking Timing

07269010

APPLICATIONS INFORMATION

TRANSIENT VOLTAGE PROTECTION

The AD5751 contains ESD protection diodes that prevent damage from normal handling. The industrial control environment can, however, subject I/O circuits to much higher transients. To protect the AD5751 from excessively high voltage transients, external power diodes and a surge current limiting resistor may be required, as shown in Figure 55. The constraint on the resistor value is that during normal operation the output level at IOUT must remain within its voltage compliance limit of $AV_{DD} - 2.75$ V and the two protection diodes and resistor must have appropriate power ratings. Further protection can be added with transient voltage suppressors if needed.

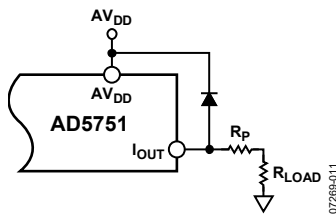

Figure 55. Output Transient Voltage Protection

THERMAL CONSIDERATIONS

It is important to understand the effects of power dissipation on the package and how it affects junction temperature. The internal junction temperature should not exceed 125°C. The AD5751 is packaged in a 32-lead, 5 mm × 5 mm LFCSP package. The thermal impedance, θ_{JA} , is 42°C/W. It is important that the devices not be operated under conditions that cause the junction temperature to exceed its limit. Worst-case conditions occur when the AD5751 are operated from the maximum AV_{DD} (55 V) and driving the maximum current (24 mA) directly to ground. The quiescent current of the AD5751 should also be taken into account, nominally ~4 mA. The following calculations estimate maximum power dissipation under these worst-case conditions, and determine maximum ambient temperature based on this. These figures assume that proper layout and grounding techniques are followed to minimize power dissipation, as outlined in the Layout Guidelines section.

Table 12. Thermal and Supply Considerations

| Considerations | 32-Lead LFCSP Package |
|--|---|
| Maximum allowed power dissipation when operating at an ambient temperature of 85°C | $\frac{T_{JMAX} - T_A}{\theta_{JA}} = \frac{125 - 85}{42} = 0.95 \text{ W}$ |
| Maximum allowed ambient temperature when operating from a supply of 55 V and driving 24 mA directly to ground (include 4 mA for internal AD5751 current) | $T_{JMAX} - (P_D \times \theta_{JA}) = 125 - ((55 \times 0.028) \times 42) = 60.3^\circ\text{C}$ |
| Maximum allowed supply voltage when operating at an ambient temperature of 85°C and driving 24 mA directly to ground | $\frac{T_{JMAX} - T_A}{AI_{DD} \times \theta_{JA}} = \frac{125 - 85}{(0.028 \times 42)} = 34 \text{ V}$ |

LAYOUT GUIDELINES

In any circuit where accuracy is important, careful consideration of the power supply and ground return layout helps to ensure the rated performance. The PCB on which the AD5751 is mounted should be designed so that the AD5751 lies on the analog plane.

The AD5751 should have ample supply bypassing of 10 μF in parallel with 0.1 μF on each supply, located as close to the package as possible, ideally right up against the device. The 10 μF capacitors are the tantalum bead type. The 0.1 μF capacitor should have low effective series resistance (ESR) and low effective series inductance (ESI) such as the common ceramic types, which provide a low impedance path to ground at high frequencies to handle transient currents due to internal logic switching.

In systems where there are many devices on one board, it is often useful to provide some heat sinking capability to allow the power to dissipate easily.

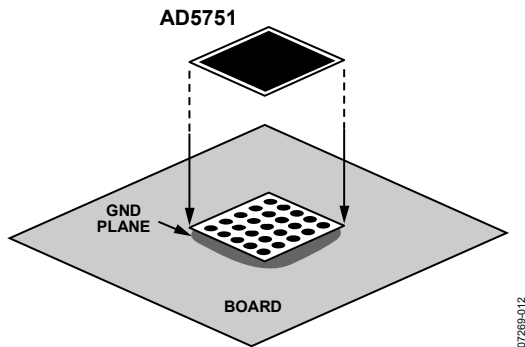

Figure 56. Paddle Connection to Board

The AD5751 has an exposed paddle beneath the device. Connect this paddle to the GND of the AD5751. For optimum performance, special considerations should be used to design the motherboard and to mount the package. For enhanced thermal, electrical, and board level performance, the exposed

paddle on the bottom of the package should be soldered to the corresponding thermal land paddle on the PCB (GND). Thermal vias should be designed into the PCB land paddle area to further improve heat dissipation.

GALVANICALLY ISOLATED INTERFACE

In many process control applications, it is necessary to provide an isolation barrier between the controller and the unit being controlled to protect and isolate the controlling circuitry from any hazardous common-mode voltages that may occur. The iCoupler® family of products from Analog Devices, Inc., provides voltage isolation in excess of 5.0 kV. The serial loading structure of the AD5751 makes it ideal for isolated interfaces because the number of interface lines is kept to a minimum. Figure 57 shows a 4-channel isolated interface to the AD5751 using an ADuM1400. For further information, visit <http://www.analog.com/icouplers>.

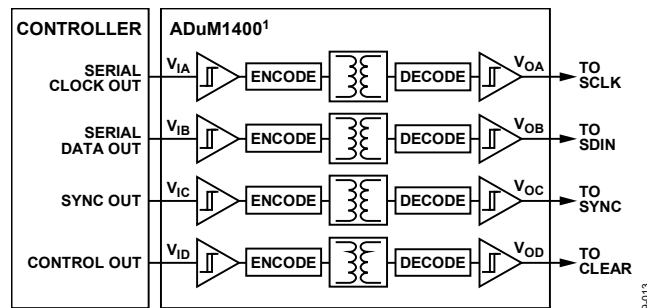

¹ADDITIONAL PINS OMITTED FOR CLARITY.

Figure 57. Isolated Interface

MICROPROCESSOR INTERFACING

Microprocessor interfacing to the AD5751 is via a serial bus that uses a protocol compatible with microcontrollers and DSP processors. The communication channel is a 3-wire (minimum) interface consisting of a clock signal, a data signal, and a SYNC signal. The AD5751 requires a 16-bit data-word with data valid on the falling edge of SCLK.

OUTLINE DIMENSIONS

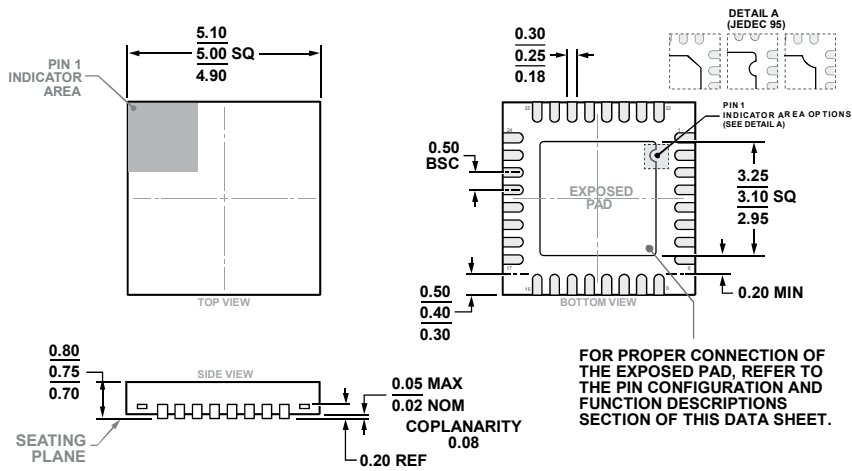

COMPLIANT TO JEDEC STANDARDS MO-220-WHHD

Figure 58. 32-Lead Lead Frame Chip Scale Package [LFCSP]
5 mm × 5 mm Body and 0.75 mm Package Height
(CP-32-7)

Dimensions shown in millimeters

ORDERING GUIDE

| Model ¹ | Temperature Range | Package Description | Package Option |
|--------------------|-------------------|---------------------|----------------|
| AD5751ACPZ | -40°C to +105°C | 32-Lead LFCSP | CP-32-7 |
| AD5751ACPZ-REEL7 | -40°C to +105°C | 32-Lead LFCSP | CP-32-7 |
| AD5751BCPZ | -40°C to +105°C | 32-Lead LFCSP | CP-32-7 |

¹ Z = RoHS Compliant Part.

NOTES

X-ON Electronics

Largest Supplier of Electrical and Electronic Components

Click to view similar products for [Instrumentation Amplifiers](#) category:

Click to view products by [Analog Devices](#) manufacturer:

Other Similar products are found below :

[ADA4254RU-EBZ](#) [JM38510/13501BGA](#) [MCP6N16-001E/MF](#) [LT1102IN8#PBF](#) [AD694BRZ-REEL7](#) [LT1101ISW](#) [JM38510/13502BGA](#)
[AD521JDZ](#) [AD521KDZ](#) [AD521LDZ](#) [AD524ADZ](#) [AD524BDZ](#) [AD524CDZ](#) [AD620ANZ](#) [AD621BNZ](#) [AD621BR](#) [AD622ANZ](#) [AD623ANZ](#)
[AD623BNZ](#) [AD624ADZ](#) [AD624CDZ](#) [AD624SD/883B](#) [AD625ADZ](#) [AD625BDZ](#) [AD625JNZ](#) [AD625KNZ](#) [AD625SD](#) [AD627BNZ](#)
[AD693AD](#) [AD693AE](#) [AD693AQ](#) [AD694AQ](#) [AD694ARZ-REEL](#) [AD694BRZ-REEL](#) [AD694JNZ](#) [AD8221ARMZ-R7](#) [AD8222HBCPZ-WP](#)
[AD8224ACPZ-R7](#) [AD8224BCPZ-WP](#) [AD8224HBCPZ-WP](#) [AD8226ARMZ-R7](#) [AD8228ARMZ](#) [AD8228ARMZ-R7](#) [AD8229HDZ](#)
[AD8236ARMZ-R7](#) [AD8237ARMZ-R7](#) [AD8253ARMZ](#) [AD8293G160BRJZ-R7](#) [AD8293G80BRJZ-R2](#) [AD8553ARMZ](#)