

FEATURES

- 11-bit, 250 MSPS output data rate per channel**
- Performance with NSR enabled**
 - SNR: 74.5 dBFS in a 55 MHz band to 90 MHz at 250 MSPS
 - SNR: 72.0 dBFS in a 82 MHz band to 90 MHz at 250 MSPS
- Performance with NSR disabled**
 - SNR: 66.2 dBFS up to 90 MHz at 250 MSPS
 - SFDR: 85 dBc up to 185 MHz at 250 MSPS
- Total power consumption: 706 mW at 200 MSPS**
- 1.8 V supply voltages**
- LVDS (ANSI-644 levels) outputs**
- Integer 1-to-8 input clock divider (625 MHz maximum input)**
- Internal ADC voltage reference**
- Flexible analog input range**
 - 1.4 V p-p to 2.0 V p-p (1.75 V p-p nominal)
- Differential analog inputs with 400 MHz bandwidth**
- 95 dB channel isolation/crosstalk**
- Serial port control**
- Energy saving power-down modes**

APPLICATIONS

- Communications**
- Diversity radio and smart antenna (MIMO) systems**
- Multimode digital receivers (3G)**
 - WCDMA, LTE, CDMA2000
 - WiMAX, TD-SCDMA
- I/Q demodulation systems**
- General-purpose software radios**

GENERAL DESCRIPTION

The AD6643 is an 11-bit, 200 MSPS/250 MSPS, dual-channel intermediate frequency (IF) receiver specifically designed to support multi-antenna systems in telecommunication applications where high dynamic range performance, low power, and small size are desired.

The device consists of two high performance analog-to-digital converters (ADCs) and noise shaping requantizer (NSR) digital blocks. Each ADC consists of a multistage, differential pipelined architecture with integrated output error correction logic, and each ADC features a wide bandwidth switched capacitor sampling network within the first stage of the differential pipeline. An integrated voltage reference eases design considerations. A duty cycle stabilizer (DCS) compensates for variations in the ADC clock duty cycle, allowing the converters to maintain excellent performance.

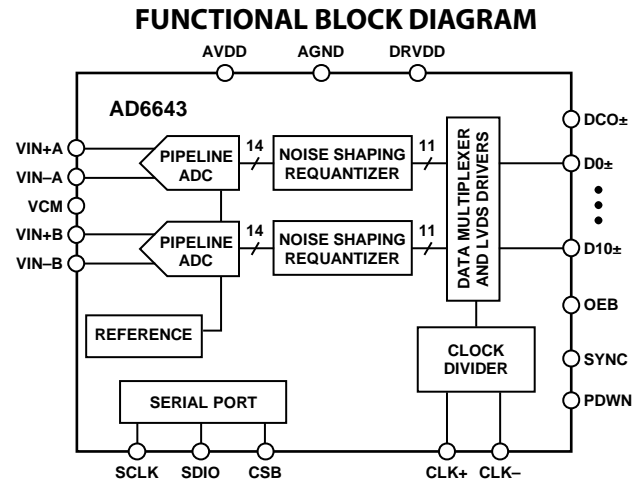

NOTES
1. THE D0± TO D10± PINS REPRESENT BOTH THE CHANNEL A AND CHANNEL B LVDS OUTPUT DATA.

Figure 1.

Each ADC output is connected internally to an NSR block. The integrated NSR circuitry allows for improved SNR performance in a smaller frequency band within the Nyquist bandwidth. The device supports two different output modes selectable via the SPI. With the NSR feature enabled, the outputs of the ADCs are processed such that the AD6643 supports enhanced SNR performance within a limited portion of the Nyquist bandwidth while maintaining an 11-bit output resolution.

The NSR block can be programmed to provide a bandwidth of either 22% or 33% of the sample clock. For example, with a sample clock rate of 185 MSPS, the AD6643 can achieve up to 75.5 dBFS SNR for a 40 MHz bandwidth in the 22% mode and up to 73.7 dBFS SNR for a 60 MHz bandwidth in the 33% mode.

(continued on Page 3)

Rev. D

[Document Feedback](#)

Information furnished by Analog Devices is believed to be accurate and reliable. However, no responsibility is assumed by Analog Devices for its use, nor for any infringements of patents or other rights of third parties that may result from its use. Specifications subject to change without notice. No license is granted by implication or otherwise under any patent or patent rights of Analog Devices. Trademarks and registered trademarks are the property of their respective owners.

One Technology Way, P.O. Box 9106, Norwood, MA 02062-9106, U.S.A.
Tel: 781.329.4700 ©2011–2019 Analog Devices, Inc. All rights reserved.
[Technical Support](#) www.analog.com

TABLE OF CONTENTS

Features	1	Voltage Reference	23
Applications	1	Clock Input Considerations	23
General Description	1	Power Dissipation and Standby Mode	24
Functional Block Diagram	1	Digital Outputs	25
Revision History	2	ADC Overrange (OR)	25
Product Highlights	3	Noise Shaping Requantizer (NSR)	26
Specifications	4	22% BW Mode (>40 MHz at 184.32 MSPS)	26
ADC DC Specifications	4	33% BW Mode (>60 MHz at 184.32 MSPS)	27
ADC AC Specifications	5	Channel/Chip Synchronization	28
Digital Specifications—AD6643-200/AD6643-250	6	Serial Port Interface (SPI)	29
Switching Specifications	8	Configuration Using the SPI	29
Timing Specifications—AD6643-200/AD6643-250	8	Hardware Interface	29
Absolute Maximum Ratings	10	SPI Accessible Features	30
Thermal Characteristics	10	Memory Map	31
ESD Caution	10	Reading the Memory Map Register Table	31
Pin Configurations and Function Descriptions	11	Memory Map Register Table	32
Typical Performance Characteristics	15	Memory Map Register Description	35
Equivalent Circuits	20	Applications Information	36
Theory of Operation	21	Design Guidelines	36
ADC Architecture	21	Outline Dimensions	37
Analog Input Considerations	21	Ordering Guide	37
REVISION HISTORY		Changes to Table 2	5
4/2019—Rev. C to Rev. D		Changes to Table 4	8
Changes to General Description Section	3	Changes to Figure 2	9
Changes to Ordering Guide	40	Change to OEB Pin Description, Table 8	12
11/2012—Rev. B to Rev. C		Changes Figure 5 and Table 9	13
Changes to Features Section	1	Changes to Typical Performance Characteristics Conditions Summary	15
Change to Table 1	1	Added AD6643-200 Throughout	15
Changes to Table 4	8	Changes to Figure 24 and Figure 25	18
Changes to Reading the Memory Map Register Table Section	31	Changes to Theory of Operation Section	19
Deleted Registers 0x0E, 0x24, and 0x25, Table 14	33	Changes to Timing Section	23
Change to Memory Map Register Description Section	36	Added ADC Overrange (OR) Section	23
Updated Outline Dimensions	37	Changed Frequency (Hz) to Frequency (MHz) in Figure 39, Figure 40, and Figure 41	24
6/2012—Rev. A to Rev. B		Changed Frequency (Hz) to Frequency (MHz) in Figure 42, Figure 43, and Figure 44	25
Changes to Features	1	Changes to Channel/Chip Synchronization Section	26
Changes to Full Power Bandwidth Parameter, Deleted Noise Bandwidth Parameter, Changes to Endnote 3; Table 2	6	Changed 0x59 to 0x3E Throughout	29
Added Figure 20 to Figure 33; Renumbered Sequentially	17	Changes to 0x02, Bits[5:4] and 0x16, Bit 5 in Table 14	30
Changes to Figure 52	24	Deleted 0x59, Table 14	32
Updated Outline Dimensions	35	Deleted SYNC Pin Control (Register 0x59) Section	33
9/2011—Rev. 0 to Rev. A		Changes to Ordering Guide	35
Added 250 MSPS Speed Grade Throughout	1	4/2011—Revision 0: Initial Version	
Changes to Table 1	4		

When the NSR block is disabled, the ADC data is provided directly to the output at a resolution of 11 bits. The AD6643 can achieve up to 66.5 dBFS SNR for the entire Nyquist bandwidth when operated in this mode. This allows the AD6643 to be used in telecommunication applications such as a digital predistortion observation path where wider bandwidths are required.

After digital signal processing, multiplexed output data is routed into an 11-bit output port such that the maximum data rate is 400 Mbps (DDR). These outputs are LVDS and support ANSI-644 levels.

The AD6643 receiver digitizes a wide spectrum of IF frequencies. Each receiver is designed for simultaneous reception of a separate antenna. This IF sampling architecture greatly reduces component cost and complexity compared with traditional analog techniques or less integrated digital methods.

Flexible power-down options allow significant power savings. Programming for device setup and control is accomplished using a 3-wire SPI-compatible serial interface with numerous modes to support board level system testing.

The AD6643 is available in a Pb-free, RoHS-compliant, 64-lead, 9 mm × 9 mm lead frame chip scale package (LFCSP_VQ) and is specified over the industrial temperature range of –40°C to +85°C. This product is protected by a U.S. patent.

PRODUCT HIGHLIGHTS

1. Two ADCs are contained in a small, space-saving, 9 mm × 9 mm × 0.85 mm, 64-lead LFCSP package.
2. Pin selectable noise shaping requantizer (NSR) function that allows for improved SNR within a reduced bandwidth of up to 60 MHz at 185 MSPS.
3. LVDS digital output interface configured for low cost FPGA families.
4. Operation from a single 1.8 V supply.
5. Standard serial port interface (SPI) that supports various product features and functions, such as data formatting (offset binary or twos complement), NSR, power-down, test modes, and voltage reference mode.
6. On-chip integer 1-to-8 input clock divider and multichip sync function to support a wide range of clocking schemes and multichannel subsystems.

SPECIFICATIONS

ADC DC SPECIFICATIONS

AVDD = 1.8 V, DRVDD = 1.8 V, maximum sample rate, VIN = -1.0 dBFS differential input, 1.75 V p-p full-scale input range, default SPI, unless otherwise noted.

Table 1.

Parameter	Temperature	AD6643-200			AD6643-250			Unit	
		Min	Typ	Max	Min	Typ	Max		
RESOLUTION	Full	11			11			Bits	
ACCURACY		Guaranteed			Guaranteed				
No Missing Codes	Full								
Offset Error	Full				±10			mV	
Gain Error	Full				+2/-6			% FSR	
Differential Nonlinearity (DNL) ¹	Full	±0.1			±0.1			LSB	
Integral Nonlinearity (INL) ¹	Full	±0.2			±0.2			LSB	
MATCHING CHARACTERISTIC									
Offset Error	25°C				±13			mV	
Gain Error	25°C				-2.5/+3.5			% FSR	
TEMPERATURE DRIFT									
Offset Error	Full	±15			±15			ppm/°C	
Gain Error	Full	±87			±87			ppm/°C	
INPUT REFERRED NOISE									
VREF = 1.75 V	25°C	0.614			0.614			LSB rms	
ANALOG INPUT									
Input Span	Full	1.75			1.75			V p-p	
Input Capacitance ²	Full	2.5			2.5			pF	
Input Resistance ³	Full	20			20			kΩ	
Input Common-Mode Voltage	Full	0.9			0.9			V	
POWER SUPPLIES									
Supply Voltage									
AVDD	Full	1.7	1.8	1.9	1.7	1.8	1.9	V	
DRVDD	Full	1.7	1.8	1.9	1.7	1.8	1.9	V	
Supply Current									
I _{AVDD} ¹	Full	238			256			275	mA
I _{DRVDD} ¹ (NSR Disabled)	Full	154			180			215	mA
I _{DRVDD} ¹ (NSR Enabled—22% Mode)	Full	172			206				mA
I _{DRVDD} ¹ (NSR Enabled—33% Mode)	Full	186			218				mA
POWER CONSUMPTION									
Sine Wave Input ¹ (DRVDD = 1.8 V, NSR Disabled)	Full	706			855				mW
Sine Wave Input ¹ (DRVDD = 1.8 V, NSR Enabled—22% Mode)	Full	738			832				mW
Sine Wave Input ¹ (DRVDD = 1.8 V, NSR Enabled—33% Mode)	Full	765			853				mW
Standby Power ⁴	Full	90			90				mW
Power-Down Power	Full	10			10				mW

¹ Measured using a 10 MHz, 0 dBFS sine wave, and 100 Ω termination on each LVDS output pair.

² Input capacitance refers to the effective capacitance between one differential input pin and its complement.

³ Input resistance refers to the effective resistance between one differential input pin and its complement.

⁴ Standby power is measured using a dc input and the CLK± pins inactive (set to AVDD or AGND).

ADC AC SPECIFICATIONS

AVDD = 1.8 V, DRVDD = 1.8 V, maximum sample rate, VIN = -1.0 dBFS differential input, 1.75 V p-p full-scale input range, default SPI, unless otherwise noted.

Table 2.

Parameter ¹	Temperature	AD6643-200			AD6643-250			Unit
		Min	Typ	Max	Min	Typ	Max	
SIGNAL-TO-NOISE-RATIO (SNR)								
NSR Disabled								
f _{IN} = 30 MHz	25°C		66.6			66.4		dBFS
f _{IN} = 90 MHz	25°C		66.5			66.2		dBFS
	Full	66.2						dBFS
f _{IN} = 140 MHz	25°C		66.4			66.1		dBFS
f _{IN} = 185 MHz	25°C		66.2			65.9		dBFS
	Full				65.3			dBFS
f _{IN} = 220 MHz	25°C		66.0			65.6		dBFS
NSR Enabled								
22% BW Mode								
f _{IN} = 30 MHz	25°C		76.1			74.8		dBFS
f _{IN} = 90 MHz	25°C		76.1			74.5		dBFS
	Full	74.5						dBFS
f _{IN} = 140 MHz	25°C		75.5			74.2		dBFS
f _{IN} = 185 MHz	25°C		74.7			73.7		dBFS
	Full				72.6			dBFS
f _{IN} = 220 MHz	25°C		74.2			73.4		dBFS
33% BW Mode								
f _{IN} = 30 MHz	25°C		76.1			72.3		dBFS
f _{IN} = 90 MHz	25°C		73.6			72.0		dBFS
	Full	72.0						dBFS
f _{IN} = 140 MHz	25°C		73.1			71.7		dBFS
f _{IN} = 185 MHz	25°C		72.6			71.2		dBFS
	Full				70.1			dBFS
f _{IN} = 220 MHz	25°C		72.1			70.9		dBFS
SIGNAL-TO-NOISE-AND-DISTORTION (SINAD)								
f _{IN} = 30 MHz	25°C		65.6			65.4		dBFS
f _{IN} = 90 MHz	25°C		65.5			65.2		dBFS
	Full	65.1						dBFS
f _{IN} = 140 MHz	25°C		65.3			65.1		dBFS
f _{IN} = 185 MHz	25°C		65.1			64.9		dBFS
	Full				64.3			dBFS
f _{IN} = 220 MHz	25°C		64.9			64.6		dBFS
WORST SECOND OR THIRD HARMONIC								
f _{IN} = 30 MHz	25°C		-92			-90		dBc
f _{IN} = 90 MHz	25°C		-91			-88		dBc
	Full			-80				dBc
f _{IN} = 140 MHz	25°C		-88			-86		dBc
f _{IN} = 185 MHz	25°C		-88			-85		dBc
	Full						-80	dBc
f _{IN} = 220 MHz	25°C		-84			-85		dBc

Parameter ¹	Temperature	AD6643-200			AD6643-250			Unit
		Min	Typ	Max	Min	Typ	Max	
SPURIOUS-FREE DYNAMIC RANGE (SFDR)								
$f_{IN} = 30$ MHz	25°C		92			90		dBc
$f_{IN} = 90$ MHz	25°C		91			88		dBc
	Full	80						dBc
$f_{IN} = 140$ MHz	25°C		88			86		dBc
$f_{IN} = 185$ MHz	25°C		88			85		dBc
	Full				79			dBc
$f_{IN} = 220$ MHz	25°C		84			85		dBc
WORST OTHER HARMONIC OR SPUR								
$f_{IN} = 30$ MHz	25°C		-94			-94		dBc
$f_{IN} = 90$ MHz	25°C		-94			-93		dBc
	Full			-80				dBc
$f_{IN} = 140$ MHz	25°C		-95			-92		dBc
$f_{IN} = 185$ MHz	25°C		-94			-92		dBc
	Full						-80	dBc
$f_{IN} = 220$ MHz	25°C		-93			-88		dBc
TWO TONE SFDR								
$f_{IN} = 184.12$ MHz, 187.12 MHz (-7 dBFS)	25°C		88			88		dBc
CROSSTALK ²	Full		95			95		dB
FULL POWER BANDWIDTH ³	25°C		1000			1000		MHz

¹ For a complete set of definitions, see the [AN-835](#) Application Note, *Understanding High Speed ADC Testing and Evaluation*.

² Crosstalk is measured at 100 MHz with -1 dBFS on one channel and with no input on the alternate channel.

³ Full power bandwidth is the bandwidth for the ADC inputs at which the spectral power of the fundamental frequency is reduced by 3 dB.

DIGITAL SPECIFICATIONS—AD6643-200/AD6643-250

AVDD = 1.8 V, DRVDD = 1.8 V, maximum sample rate, VIN = -1.0 dBFS differential input, 1.75 V p-p full-scale input range, DCS enabled, default SPI, unless otherwise noted.

Table 3.

Parameter	Temperature	Min	Typ	Max	Unit
DIFFERENTIAL CLOCK INPUTS (CLK+, CLK-)					
Logic Compliance			CMOS/LVDS/LVPECL		
Internal Common-Mode Bias	Full		0.9		V
Differential Input Voltage	Full	0.3		3.6	V p-p
Input Voltage Range	Full	AGND		AVDD	V
Input Common-Mode Range	Full	0.9		1.4	V
Input Current Level					
High	Full	10		22	μA
Low	Full	-22		-10	μA
Input Capacitance	Full		4		pF
Input Resistance	Full	8	10	12	kΩ
SYNC INPUT					
Logic Compliance			CMOS/LVDS		
Internal Bias	Full		0.9		V
Input Voltage Range	Full	AGND		AVDD	V
Input Voltage Level					
High	Full	1.2		AVDD	V
Low	Full	AGND		0.6	V

Parameter	Temperature	Min	Typ	Max	Unit
Input Current Level					
High	Full	-5		+5	μA
Low	Full	-100		+100	μA
Input Capacitance	Full		1		pF
Input Resistance	Full	12	16	20	kΩ
LOGIC INPUT (CSB)¹					
Input Voltage Level					
High	Full	1.22		2.1	V
Low	Full	0		0.6	V
Input Current Level					
High	Full	-5		+5	μA
Low	Full	-80		-45	μA
Input Resistance	Full		26		kΩ
Input Capacitance	Full		2		pF
LOGIC INPUT (SCLK)²					
Input Voltage Level					
High	Full	1.22		2.1	V
Low	Full	0		0.6	V
Input Current Level					
High	Full	45		70	μA
Low	Full	-5		+5	μA
Input Resistance	Full		26		kΩ
Input Capacitance	Full		2		pF
LOGIC INPUTS (SDIO)¹					
Input Voltage Level					
High	Full	1.22		2.1	V
Low	Full	0		0.6	V
Input Current Level					
High	Full	45		70	μA
Low	Full	-5		+5	μA
Input Resistance	Full		26		kΩ
Input Capacitance	Full		5		pF
LOGIC INPUTS (OEB, PDWN)²					
Input Voltage Level					
High	Full	1.22		2.1	V
Low	Full	0		0.6	V
Input Current Level					
High	Full	45		70	μA
Low	Full	-5		+5	μA
Input Resistance	Full		26		kΩ
Input Capacitance	Full		5		pF
DIGITAL OUTPUTS					
LVDS Data and OR Outputs					
Differential Output Voltage (VOD)					
ANSI Mode	Full	250	350	450	mV
Reduced Swing Mode	Full	150	200	280	mV
Output Offset Voltage (VOS)					
ANSI Mode	Full	1.15	1.25	1.35	V
Reduced Swing Mode	Full	1.15	1.25	1.35	V

¹ Pull up.² Pull down.

SWITCHING SPECIFICATIONS

Table 4.

Parameter	Symbol	Temperature	AD6643-200			AD6643-250			Unit
			Min	Typ	Max	Min	Typ	Max	
CLOCK INPUT PARAMETERS									
Input Clock Rate		Full			625			625	MHz
Conversion Rate ¹		Full	40		200	40		250	MSPS
CLK Period—Divide-by-1 Mode ²	t_{CLK}	Full	4.0			4			ns
CLK Pulse Width High ²	t_{CH}								
Divide-by-1 Mode, DCS Enabled		Full	2.25	2.5	2.75	1.8	2.0	2.2	ns
Divide-by-1 Mode, DCS Disabled		Full	2.375	2.5	2.625	1.9	2.0	2.1	ns
Divide-by-2 Through Divide-by-8 Modes, DCS Enabled		Full	0.8			0.8			ns
DATA OUTPUT PARAMETERS (DATA, OR)									
LVDS Mode								1.0	
Data Propagation Delay ²	t_{PD}	Full		6.0				0.1	ns
DCO Propagation Delay ²	t_{DCO}	Full		6.7				6.7	ns
DCO to Data Skew ²	t_{SKEW}	Full	0.4	0.7	1.0	0.4	0.7	1.0	ns
Pipeline Delay (Latency)		Full		10				10	Cycles ³
NSR Enabled		Full		13				13	Cycles ³
Aperture Delay ⁴	t_A	Full		1.0				1.0	ns
Aperture Uncertainty (Jitter) ⁴	t_J	Full		0.1				0.1	ps rms
Wake-Up Time (from Standby)		Full		10				10	μ s
Wake-Up Time (from Power-Down)		Full		250				250	μ s
OUT-OF-RANGE RECOVERY TIME		Full		3				3	Cycles

¹ Conversion rate is the clock rate after the divider.

² See Figure 2 for timing diagram.

³ Cycles refers to ADC input sample rate cycles.

⁴ Not shown in timing diagrams.

TIMING SPECIFICATIONS—AD6643-200/AD6643-250

Table 5.

Parameter	Conditions	Min	Typ	Max	Unit
SYNC TIMING REQUIREMENTS					
t_{SSYNC}	See Figure 3 for timing details SYNC to the rising edge of CLK setup time		0.3		ns
t_{HSYNC}	SYNC to the rising edge of CLK hold time		0.4		ns
SPI TIMING REQUIREMENTS					
t_{DS}	See Figure 59 for SPI timing diagram Setup time between the data and the rising edge of SCLK	2			ns
t_{DH}	Hold time between the data and the rising edge of SCLK	2			ns
t_{CLK}	Period of the SCLK	40			ns
t_S	Setup time between CSB and SCLK	2			ns
t_H	Hold time between CSB and SCLK	2			ns
t_{HIGH}	Minimum period that SCLK should be in a logic high state	10			ns
t_{LOW}	Minimum period that SCLK should be in a logic low state	10			ns
t_{EN_SDIO}	Time required for the SDIO pin to switch from an input to an output relative to the SCLK falling edge (not shown in Figure 59)	10			ns
t_{DIS_SDIO}	Time required for the SDIO pin to switch from an output to an input relative to the SCLK rising edge (not shown in Figure 59)	10			ns

Timing Diagrams

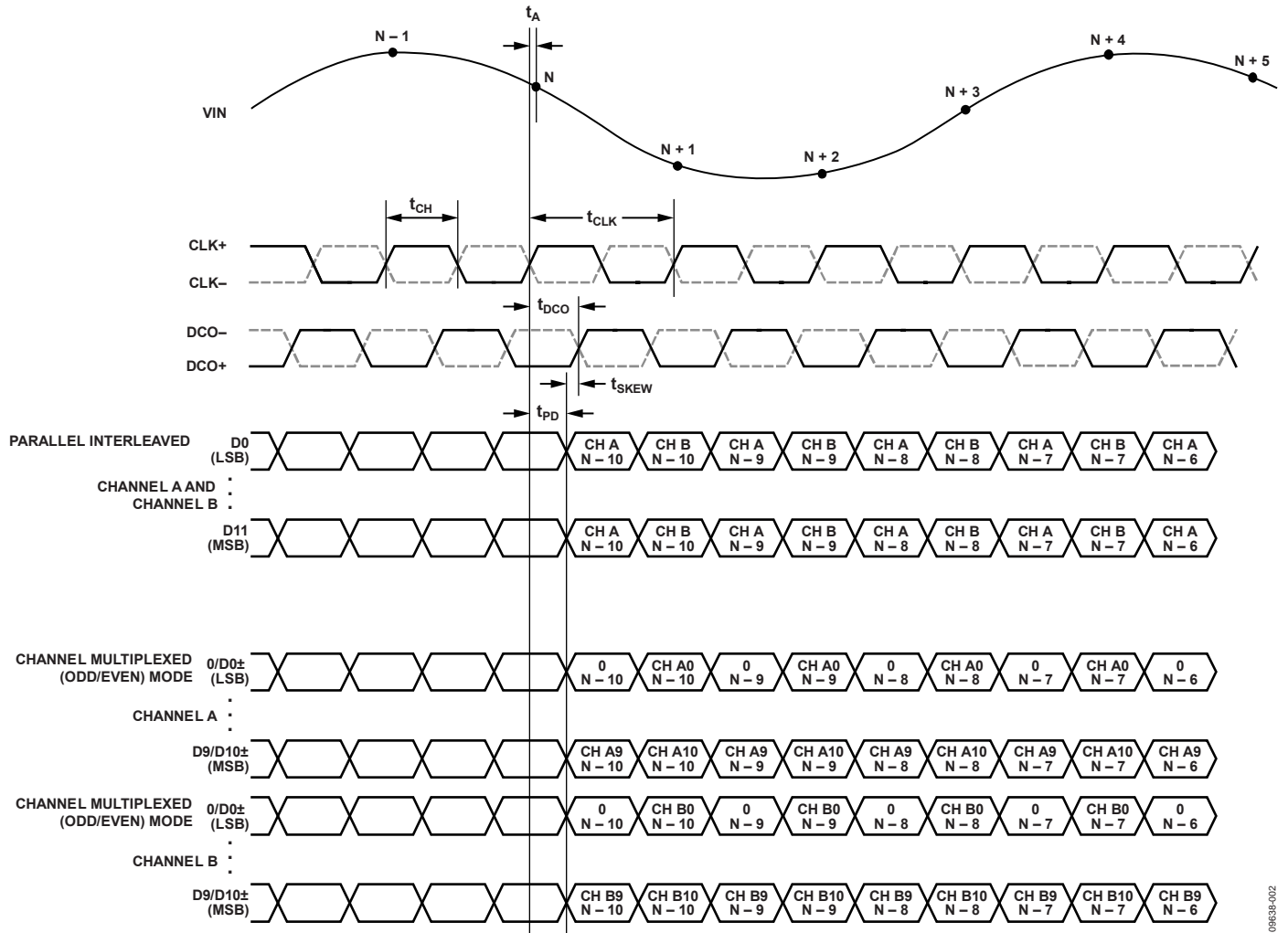

Figure 2. LVDS Modes for Data Output Timing Latency. NSR Disabled (Enabling NSR Adds an Additional Three Clock Cycles of Latency)

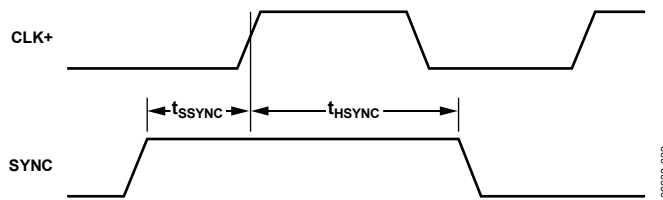

Figure 3. SYNC Timing Inputs

ABSOLUTE MAXIMUM RATINGS

Table 6.

Parameter	Rating
Electrical	
AVDD to AGND	-0.3 V to +2.0 V
DRVDD to AGND	-0.3 V to +2.0 V
VIN+/VIN-, VIN-/VIN- to AGND	-0.3 V to AVDD + 0.2 V
CLK+, CLK- to AGND	-0.3 V to AVDD + 0.2 V
SYNC to AGND	-0.3 V to AVDD + 0.2 V
VCM to AGND	-0.3 V to AVDD + 0.2 V
CSB to AGND	-0.3 V to DRVDD + 0.3 V
SCLK to AGND	-0.3 V to DRVDD + 0.3 V
SDIO to AGND	-0.3 V to DRVDD + 0.3 V
OEB to AGND	-0.3 V to DRVDD + 0.3 V
PDWN to AGND	-0.3 V to DRVDD + 0.3 V
OR+/OR- to AGND	-0.3 V to DRVDD + 0.3 V
D0-/D0+ Through D10-/D10+ to AGND	-0.3 V to DRVDD + 0.3 V
DCO+/DCO- to AGND	-0.3 V to DRVDD + 0.3 V
Environmental	
Operating Temperature Range (Ambient)	-40°C to +85°C
Maximum Junction Temperature Under Bias	150°C
Storage Temperature Range (Ambient)	-65°C to +125°C

Stresses above those listed under Absolute Maximum Ratings may cause permanent damage to the device. This is a stress rating only; functional operation of the device at these or any other conditions above those indicated in the operational section of this specification is not implied. Exposure to absolute maximum rating conditions for extended periods may affect device reliability.

THERMAL CHARACTERISTICS

The exposed paddle must be soldered to the ground plane for the LFCSP package. Soldering the exposed paddle to the printed circuit board (PCB) increases the reliability of the solder joints, maximizing the thermal capability of the package.

Typical θ_{JA} is specified for a 4-layer PCB that uses a solid ground plane. As listed in Table 7, airflow increases heat dissipation, which reduces θ_{JA} . In addition, metal in direct contact with the package leads from metal traces, through holes, ground, and power planes, reduces the θ_{JA} .

Table 7. Thermal Resistance

Package Type	Airflow Velocity (m/sec)	$\theta_{JA}^{1,2}$	$\theta_{JC}^{1,3}$	$\theta_{JB}^{1,4}$	Unit
64-Lead LFCSP 9 mm × 9 mm (CP-64-4)	0	26.8	1.14	10.4	°C/W
	1.0	21.6			°C/W
	2.0	20.2			°C/W

¹ Per JEDEC 51-7, plus JEDEC 25-5 252P test board.

² Per JEDEC JESD51-2 (still air) or JEDEC JESD51-6 (moving air).

³ Per MIL-Std 883, Method 1012.1.

⁴ Per JEDEC JESD51-8 (still air).

ESD CAUTION



ESD (electrostatic discharge) sensitive device. Charged devices and circuit boards can discharge without detection. Although this product features patented or proprietary protection circuitry, damage may occur on devices subjected to high energy ESD. Therefore, proper ESD precautions should be taken to avoid performance degradation or loss of functionality.

PIN CONFIGURATIONS AND FUNCTION DESCRIPTIONS

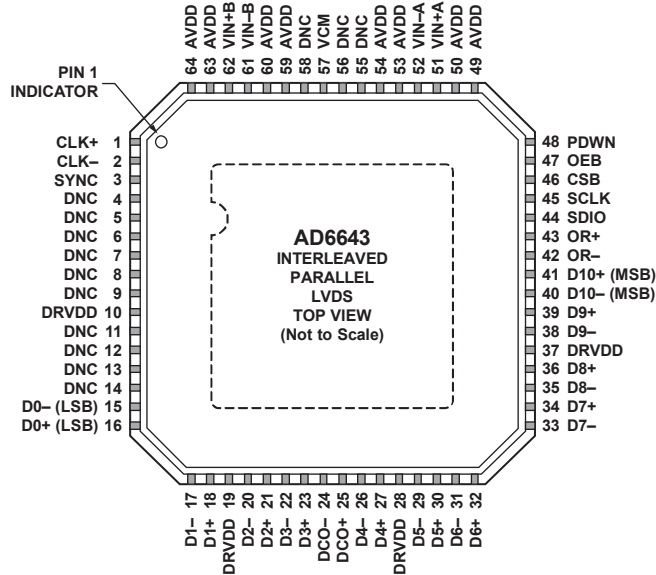

- NOTES**
1. DNC = DO NOT CONNECT. DO NOT CONNECT TO THIS PIN.
 2. THE EXPOSED THERMAL PADDLE ON THE BOTTOM OF THE PACKAGE PROVIDES THE ANALOG GROUND FOR THE PART. THIS EXPOSED PADDLE MUST BE CONNECTED TO GROUND FOR PROPER OPERATION.

Figure 4. Pin Configuration (Top View), LFCSP Interleaved Parallel LVDS

09839-004

Table 8. Pin Function Descriptions for the Interleaved Parallel LVDS Mode

Pin No.	Mnemonic	Type	Description
ADC Power Supplies			
10, 19, 28, 37	DRVDD	Supply	Digital Output Driver Supply (1.8 V Nominal).
49, 50, 53, 54, 59, 60, 63, 64	AVDD	Supply	Analog Power Supply (1.8 V Nominal).
4 to 9, 11 to 14, 55, 56, 58	DNC		Do Not Connect. Do not connect to these pins.
0	AGND, Exposed Paddle	Ground	Analog Ground. The exposed thermal paddle on the bottom of the package provides the analog ground for the device. This exposed paddle must be connected to ground for proper operation.
ADC Analog			
51	VIN+A	Input	Differential Analog Input Pin (+) for Channel A.
52	VIN-A	Input	Differential Analog Input Pin (-) for Channel A.
62	VIN+B	Input	Differential Analog Input Pin (+) for Channel B.
61	VIN-B	Input	Differential Analog Input Pin (-) for Channel B.
57	VCM	Output	Common-Mode Level Bias Output for Analog Inputs. This pin should be decoupled to ground using a 0.1 μF capacitor.
1	CLK+	Input	ADC Clock Input—True.
2	CLK-	Input	ADC Clock Input—Complement.
Digital Input			
3	SYNC	Input	Digital Synchronization Pin. Slave mode only.
Digital Outputs			
15	D0- (LSB)	Output	Channel A/Channel B LVDS Output Data 0—True.
16	D0+ (LSB)	Output	Channel A/Channel B LVDS Output Data 0—Complement.
18	D1+	Output	Channel A/Channel B LVDS Output Data 1—True.
17	D1-	Output	Channel A/Channel B LVDS Output Data 1—Complement.
21	D2+	Output	Channel A/Channel B LVDS Output Data 2—True.
20	D2-	Output	Channel A/Channel B LVDS Output Data 2—Complement.
23	D3+	Output	Channel A/Channel B LVDS Output Data 3—True.
22	D3-	Output	Channel A/Channel B LVDS Output Data 3—Complement.
27	D4+	Output	Channel A/Channel B LVDS Output Data 4—True.

Pin No.	Mnemonic	Type	Description
26	D4–	Output	Channel A/Channel B LVDS Output Data 4—Complement.
30	D5+	Output	Channel A/Channel B LVDS Output Data 5—True.
29	D5–	Output	Channel A/Channel B LVDS Output Data 5—Complement.
32	D6+	Output	Channel A/Channel B LVDS Output Data 6—True.
31	D6–	Output	Channel A/Channel B LVDS Output Data 6—Complement.
34	D7+	Output	Channel A/Channel B LVDS Output Data 7—True.
33	D7–	Output	Channel A/Channel B LVDS Output Data 7—Complement.
36	D8+	Output	Channel A/Channel B LVDS Output Data 8—True.
35	D8–	Output	Channel A/Channel B LVDS Output Data 8—Complement.
39	D9+	Output	Channel A/Channel B LVDS Output Data 9—True.
38	D9–	Output	Channel A/Channel B LVDS Output Data 9—Complement.
41	D10+ (MSB)	Output	Channel A/Channel B LVDS Output Data 10—True.
40	D10– (MSB)	Output	Channel A/Channel B LVDS Output Data 10—Complement.
43	OR+	Output	Channel A/Channel B LVDS Overrange—True.
42	OR–	Output	Channel A/Channel B LVDS Overrange—Complement.
25	DCO+	Output	Channel A/Channel B LVDS Data Clock Output—True.
24	DCO–	Output	Channel A/Channel B LVDS Data Clock Output—Complement.
SPI Control			
45	SCLK	Input	SPI Serial Clock. The serial shift clock input, which is used to synchronize serial interface reads and writes.
44	SDIO	Input/Output	SPI Serial Data I/O. A dual purpose pin that typically serves as an input or an output, depending on the instruction being sent and the relative position in the timing frame.
46	CSB	Input	Chip Select Bar (Active Low). CSB gates the read and write cycles.
Output Enable Bar and Power-Down			
47	OEB	Input/Output	Output Enable Bar Input (Active Low).
48	PDWN	Input/Output	Power-Down Input (Active High). The operation of this pin depends on the SPI mode and can be configured as power-down or standby (see Table 14).

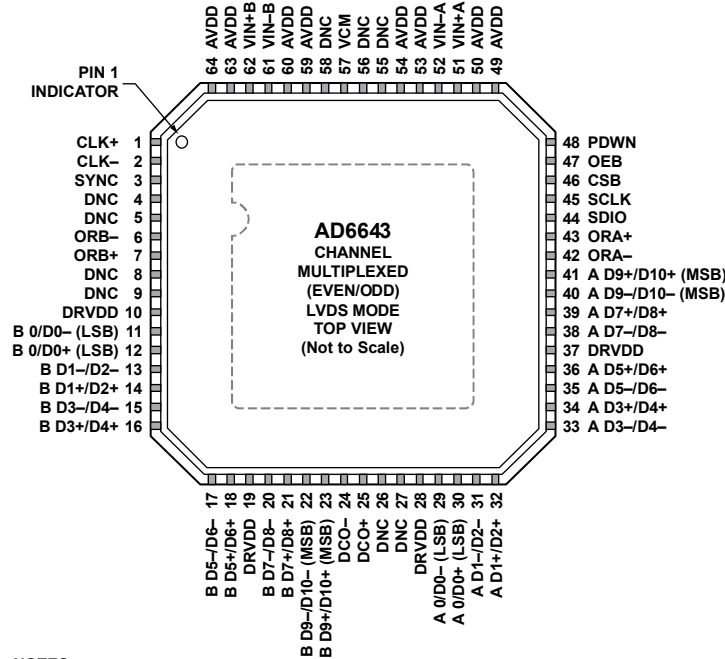

- NOTES**
1. DNC = DO NOT CONNECT. DO NOT CONNECT TO THIS PIN.
 2. THE EXPOSED THERMAL PADDLE ON THE BOTTOM OF THE PACKAGE PROVIDES THE ANALOG GROUND FOR THE PART. THIS EXPOSED PADDLE MUST BE CONNECTED TO GROUND FOR PROPER OPERATION.

Figure 5. Pin Configuration (Top View), LFCSP Channel Multiplexed (Even/Odd) LVDS

Table 9. Pin Function Descriptions for the Channel Multiplexed (Even/Odd) LVDS Mode

Pin No.	Mnemonic	Type	Description
ADC Power Supplies			
10, 19, 28, 37	DRVDD	Supply	Digital Output Driver Supply (1.8 V Nominal).
49, 50, 53, 54, 59, 60, 63, 64	AVDD	Supply	Analog Power Supply (1.8 V Nominal).
4, 5, 8, 9, 26, 27, 55, 56, 58	DNC		Do Not Connect. Do not connect to these pins.
0	AGND, Exposed Paddle	Ground	The exposed thermal paddle on the bottom of the package provides the analog ground for the part. This exposed paddle must be connected to ground for proper operation.
ADC Analog			
51	VIN+A	Input	Differential Analog Input Pin (+) for Channel A.
52	VIN-A	Input	Differential Analog Input Pin (-) for Channel A.
62	VIN+B	Input	Differential Analog Input Pin (+) for Channel B.
61	VIN-B	Input	Differential Analog Input Pin (-) for Channel B.
57	VCM	Output	Common-Mode Level Bias Output for Analog Inputs. This pin should be decoupled to ground using a 0.1 μF capacitor.
1	CLK+	Input	ADC Clock Input—True.
2	CLK-	Input	ADC Clock Input—Complement.
Digital Input			
3	SYNC	Input	Digital Synchronization Pin. Slave mode only.
Digital Outputs			
7	ORB+	Output	Channel B LVDS Overrange Output—True. The overrange indication is valid on the rising edge of the DCO.
6	ORB-	Output	Channel B LVDS Overrange Output—Complement. The overrange indication is valid on the rising edge of the DCO.
11	B 0/D0- (LSB)	Output	Channel B LVDS Output 0/Data 0—Complement. The output bit on the rising edge of the data clock output (DCO) from this output is always a Logic 0.
12	B 0/D0+ (LSB)	Output	Channel B LVDS Output 0/Data 0—True. The output bit on the rising edge of the data clock output (DCO) from this output is always a Logic 0.

Pin No.	Mnemonic	Type	Description
13	B D1-/D2-	Output	Channel B LVDS Output Data 1/Data 2—Complement.
14	B D1+/D2+	Output	Channel B LVDS Output Data 1/Data 2—True.
15	B D3-/D4-	Output	Channel B LVDS Output Data 3/Data 4—Complement.
16	B D3+/D4+	Output	Channel B LVDS Output Data 3/Data 4—True.
17	B D5-/D6-	Output	Channel B LVDS Output Data 5/Data 6—Complement.
18	B D5+/D6+	Output	Channel B LVDS Output Data 5/Data 6—True.
20	B D7-/D8-	Output	Channel B LVDS Output Data 7/Data 8—Complement.
21	B D7+/D8+	Output	Channel B LVDS Output Data 7/Data 8—True.
22	B D9-/D10- (MSB)	Output	Channel B LVDS Output Data 9/Data 10—Complement.
23	B D9+/D10+ (MSB)	Output	Channel B LVDS Output Data 9/Data 10—True.
29	A 0/D0- (LSB)	Output	Channel B LVDS Output 0/Data 1—Complement. The first output bit from this output is always a Logic 0.
30	A 0/D0+ (LSB)	Output	Channel B LVDS Output 0/Data 1—True. The first output bit from this output is always a Logic 0.
31	A D1-/D2-	Output	Channel A LVDS Output Data 1/Data 0—Complement.
32	A D1+/D2+	Output	Channel A LVDS Output Data 1/Data 0—True.
33	A D3-/D4-	Output	Channel A LVDS Output Data 3/Data 2—Complement.
34	A D3+/D4+	Output	Channel A LVDS Output Data 3/Data 2—True.
35	A D5-/D6-	Output	Channel A LVDS Output Data 5/Data 4—Complement.
36	A D5+/D6+	Output	Channel A LVDS Output Data 5/Data 4—True.
38	A D7-/D8-	Output	Channel A LVDS Output Data 7/Data 6—Complement.
39	A D7+/D8+	Output	Channel A LVDS Output Data 7/Data 6—True.
40	A D9-/D10- (MSB)	Output	Channel A LVDS Output Data 9/Data 8—Complement.
41	A D9+/D10+ (MSB)	Output	Channel A LVDS Output Data 9/Data 8—True.
43	ORA+	Output	Channel A LVDS Overage Output—True. The overrange indication is valid on the rising edge of the DCO.
42	ORA-	Output	Channel A LVDS Overage Output—Complement. The overrange indication is valid on the rising edge of the DCO.
25	DCO+	Output	Channel A/Channel B LVDS Data Clock Output—True.
24	DCO-	Output	Channel A/Channel B LVDS Data Clock Output—Complement.
SPI Control			
45	SCLK	Input	SPI Serial Clock (SCKL). The serial shift clock input, which is used to synchronize serial interface reads and writes.
44	SDIO	Input/Output	SPI Serial Data Input/Output (SDIO). A dual purpose pin that typically serves as an input or an output, depending on the instruction being sent and the relative position in the timing frame.
46	CSB	Input	SPI Chip Select Bar (Active Low). An active low control that gates the read and write cycles.
Output Enable Bar and Power-Down			
47	OEB	Input	Output Enable Bar Input (Active Low).
48	PDWN	Input	Power-Down Input (Active High). The operation of this pin depends on the SPI mode and can be configured as power-down or standby (see Table 14).

TYPICAL PERFORMANCE CHARACTERISTICS

AVDD = 1.8 V, DRVDD = 1.8 V, sample rate = maximum sample rate per speed grade, DCS enabled, 1.75 V p-p differential input, VIN = -1.0 dBFS, 32k sample, TA = 25°C, unless otherwise noted.

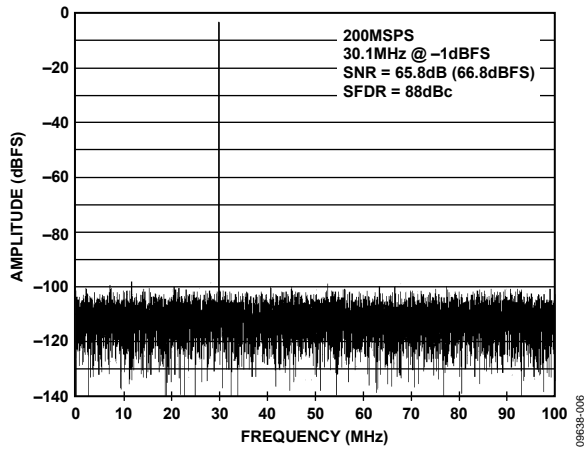

Figure 6. AD6643-200 Single Tone FFT, $f_{IN} = 30.1$ MHz

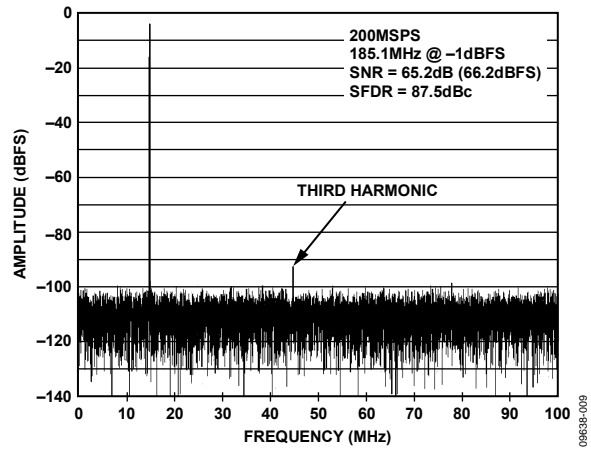

Figure 9. AD6643-200 Single Tone FFT, $f_{IN} = 185.1$ MHz

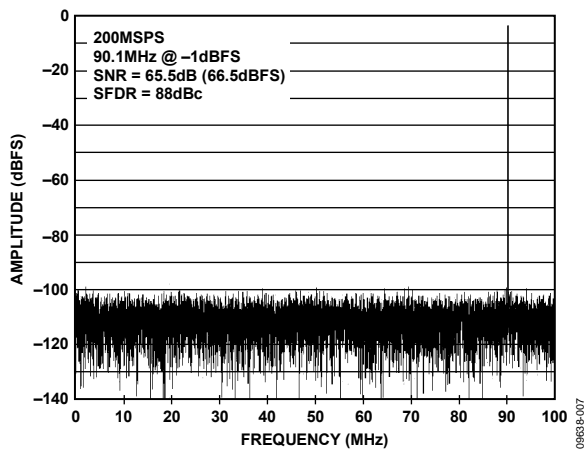

Figure 7. AD6643-200 Single Tone FFT, $f_{IN} = 90.1$ MHz

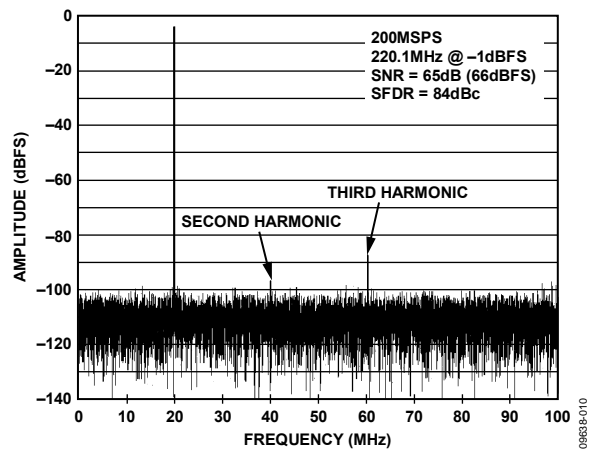

Figure 10. AD6643-200 Single Tone FFT, $f_{IN} = 220.1$ MHz

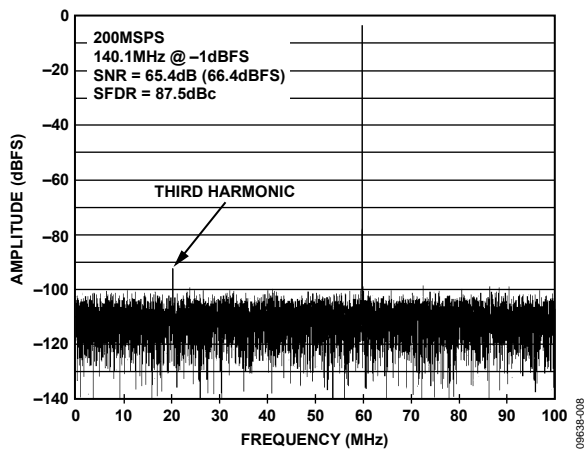

Figure 8. AD6643-200 Single Tone FFT, $f_{IN} = 140.1$ MHz

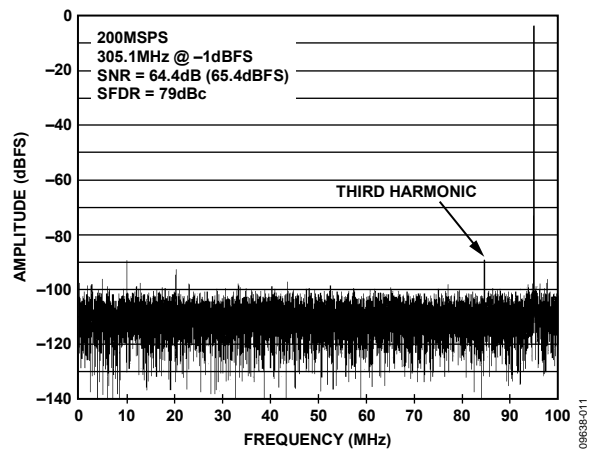

Figure 11. AD6643-200 Single Tone FFT, $f_{IN} = 305.1$ MHz

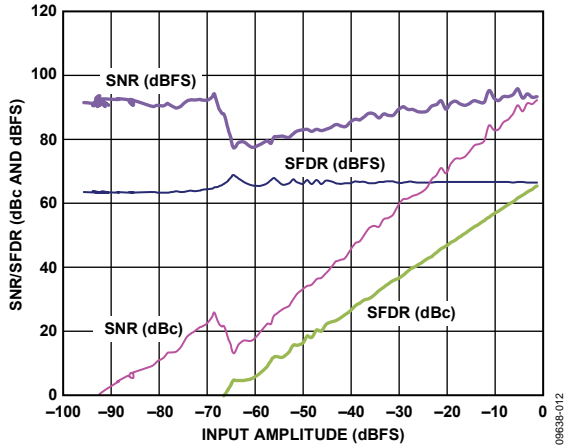

Figure 12. AD6643-200 Single Tone SNR/SFDR vs. Input Amplitude (A_{IN}), $f_{IN} = 90.1$ MHz

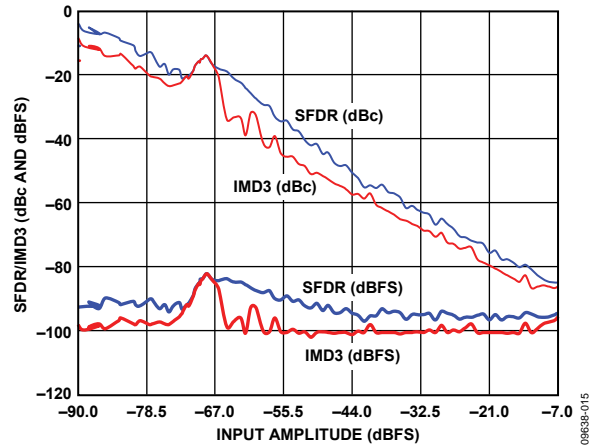

Figure 15. AD6643-200 Two Tone SFDR/IMD3 vs. Input Amplitude (A_{IN}) with $f_{IN1} = 184.12$ MHz, $f_{IN2} = 187.12$ MHz

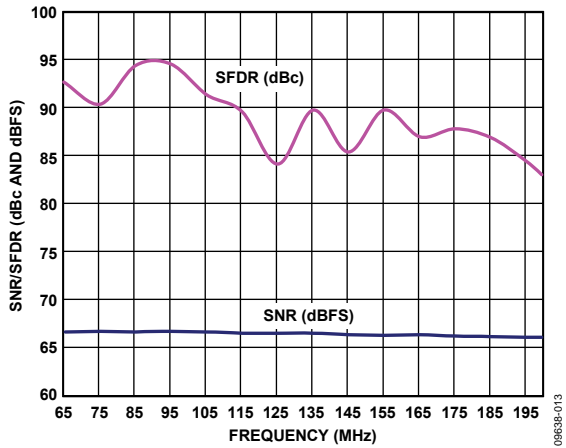

Figure 13. AD6643-200 Single Tone SNR/SFDR vs. Input Frequency (f_{IN})

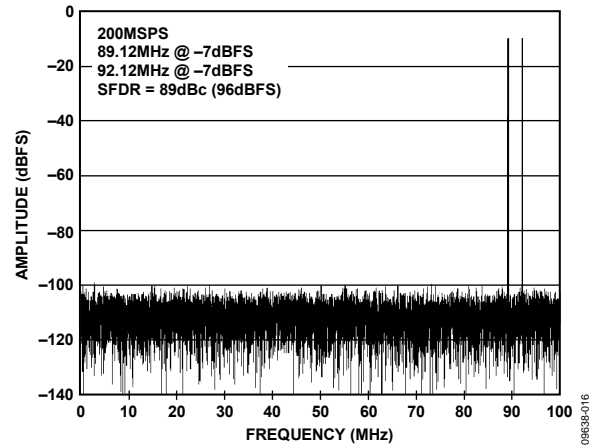

Figure 16. AD6643-200 Two Tone FFT with $f_{IN1} = 89.12$ MHz, $f_{IN2} = 92.12$ MHz

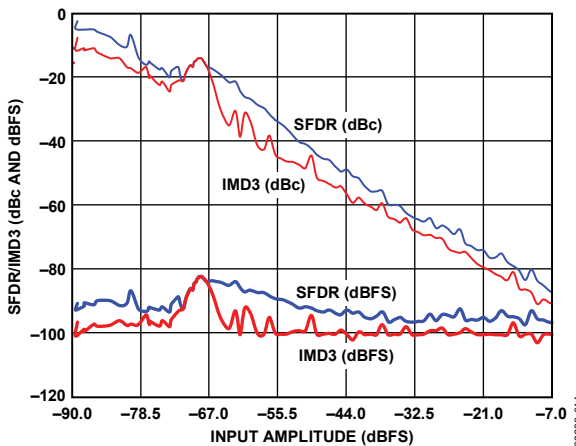

Figure 14. AD6643-200 Two Tone SFDR/IMD3 vs. Input Amplitude (A_{IN}) with $f_{IN1} = 89.12$ MHz, $f_{IN2} = 92.12$ MHz

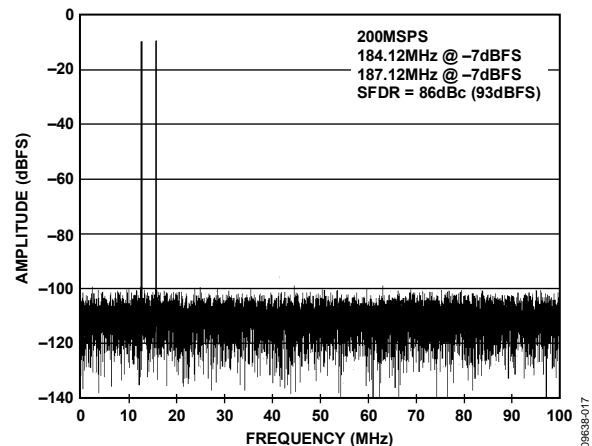

Figure 17. AD6643-200 Two Tone FFT with $f_{IN1} = 184.12$ MHz, $f_{IN2} = 187.12$ MHz

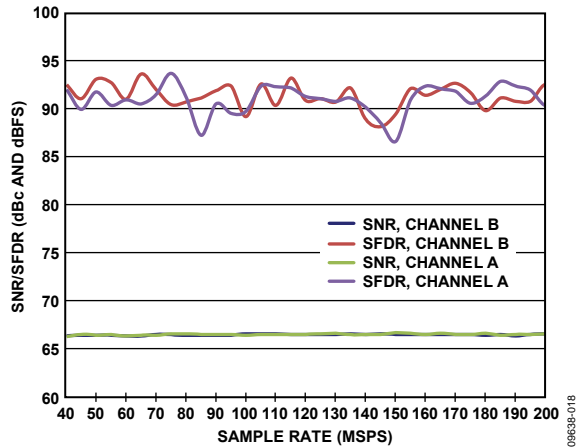

Figure 18. AD6643-200 Single Tone SNR/SFDR vs. Sample Rate (f_s) with $f_{IN} = 90.1$ MHz

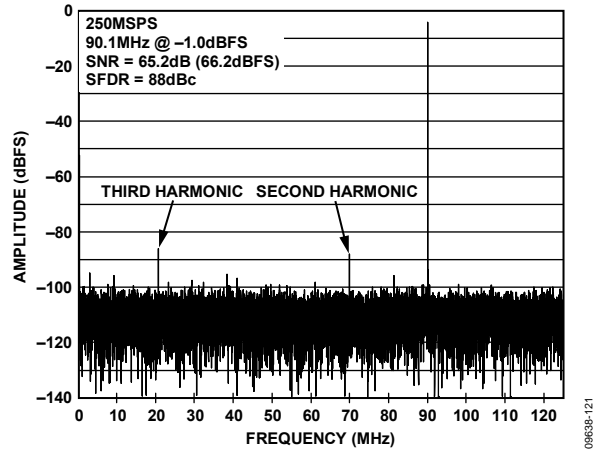

Figure 21. AD6643-250 Single Tone FFT, $f_{IN} = 90.1$ MHz

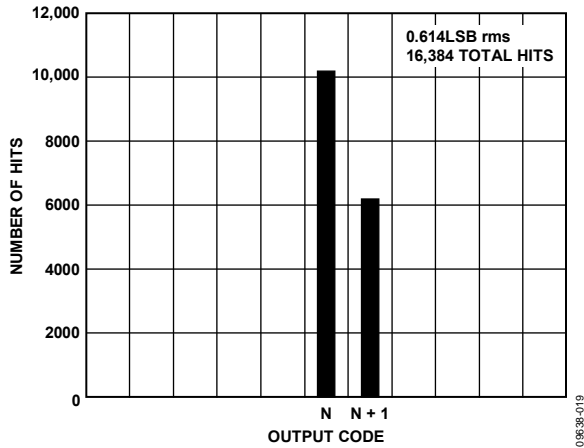

Figure 19. AD6643-200 Grounded Input Histogram

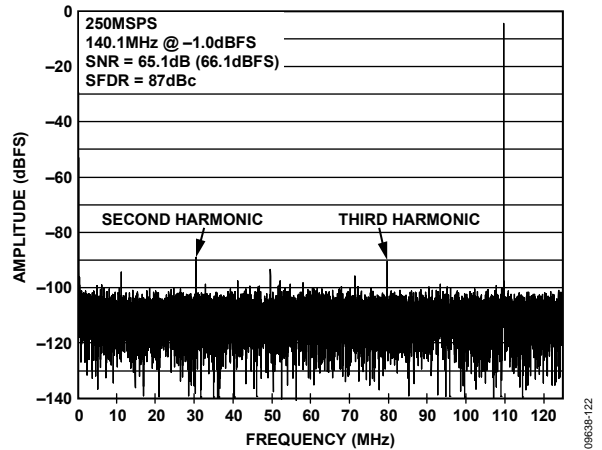

Figure 22. AD6643-250 Single Tone FFT, $f_{IN} = 140.1$ MHz

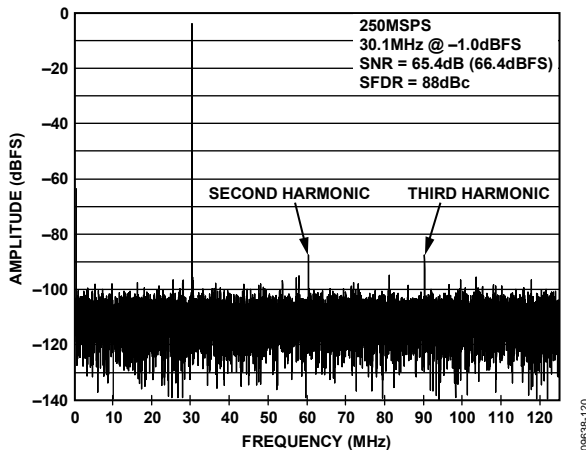

Figure 20. AD6643-250 Single Tone FFT, $f_{IN} = 30.1$ MHz

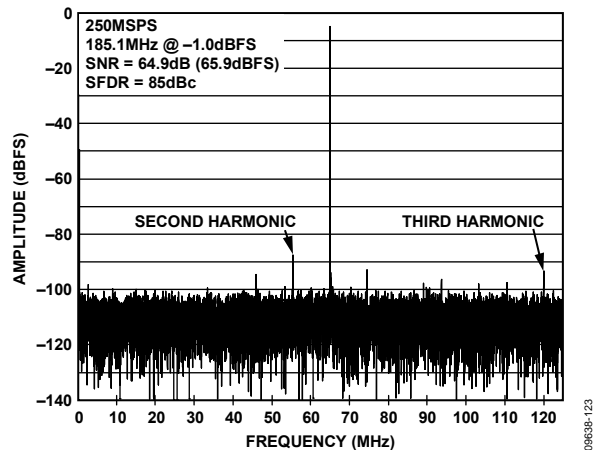

Figure 23. AD6643-250 Single Tone FFT, $f_{IN} = 185.1$ MHz

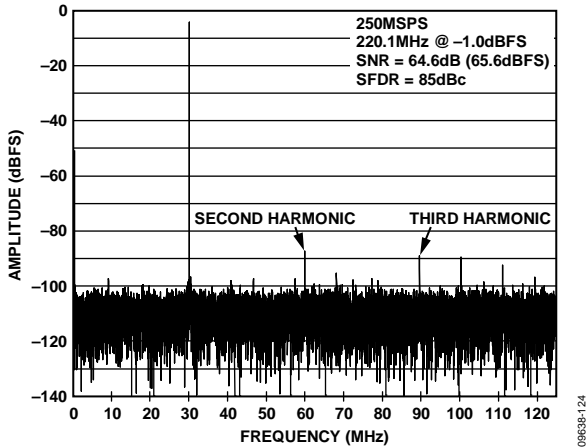

Figure 24. AD6643-250 Single Tone FFT, $f_{IN} = 220.1$ MHz

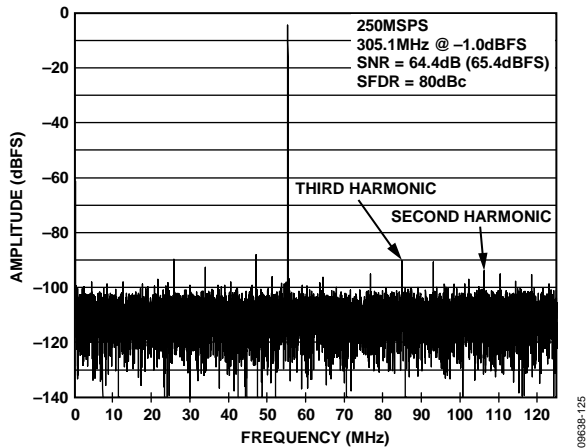

Figure 25. AD6643-250 Single Tone FFT, $f_{IN} = 305.1$ MHz

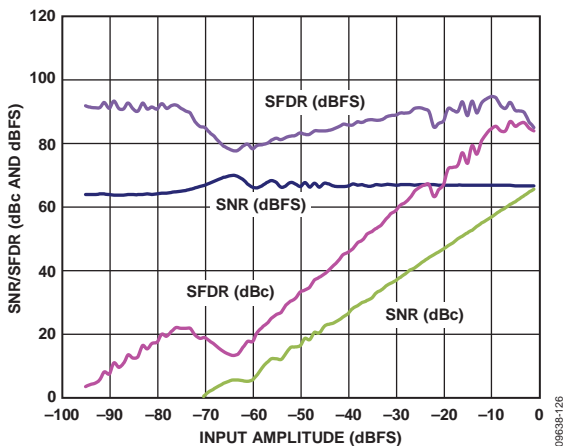

Figure 26. AD6643-250 Single Tone SNR/SFDR vs. Input Amplitude (A_{IN}) with $f_{IN} = 90.1$ MHz

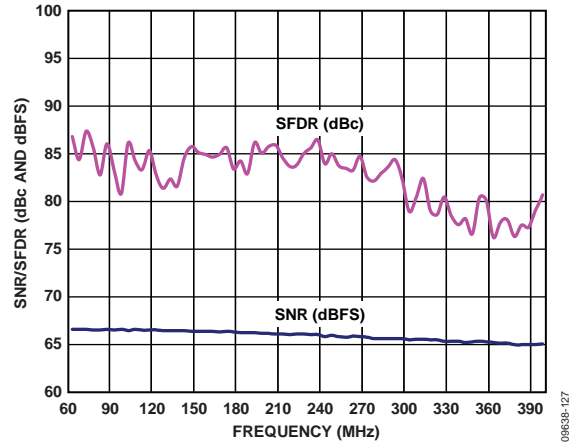

Figure 27. AD6643-250 Single Tone SNR/SFDR vs. Input Frequency (f_{IN}), $V_{REF} = 1.75$ V p-p

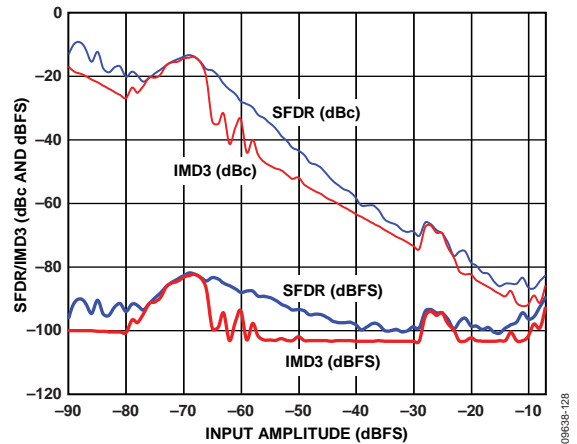

Figure 28. AD6643-250 Two Tone SFDR/IMD3 vs. Input Amplitude (A_{IN}) with $f_{IN1} = 89.12$ MHz, $f_{IN2} = 92.12$ MHz

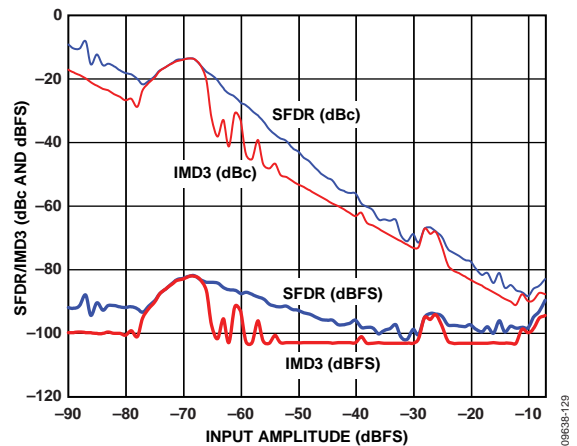

Figure 29. AD6643-250 Two Tone SFDR/IMD3 vs. Input Amplitude (A_{IN}) with $f_{IN1} = 184.12$ MHz, $f_{IN2} = 187.12$ MHz

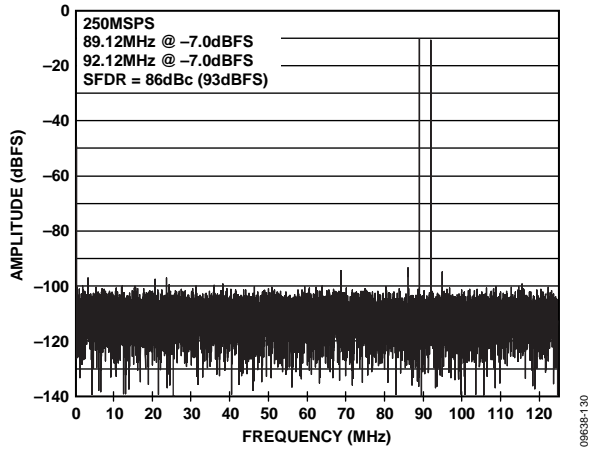

Figure 30. AD6643-250 Two Tone FFT with $f_{IN1} = 89.12$ MHz, $f_{IN2} = 92.12$ MHz

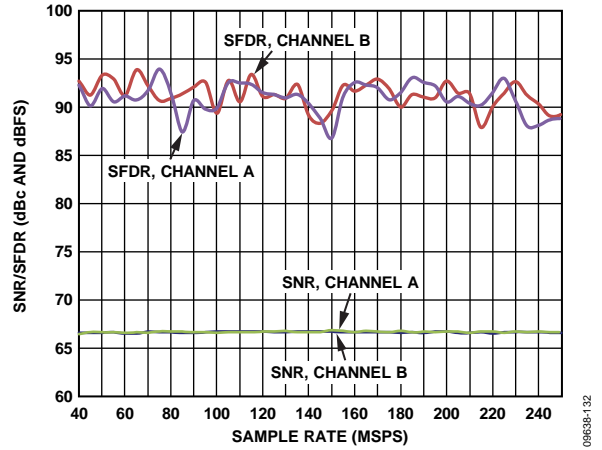

Figure 32. AD6643-250 Single Tone SNR/SFDR vs. Sample Rate (f_s) with $f_{IN} = 90.1$ MHz

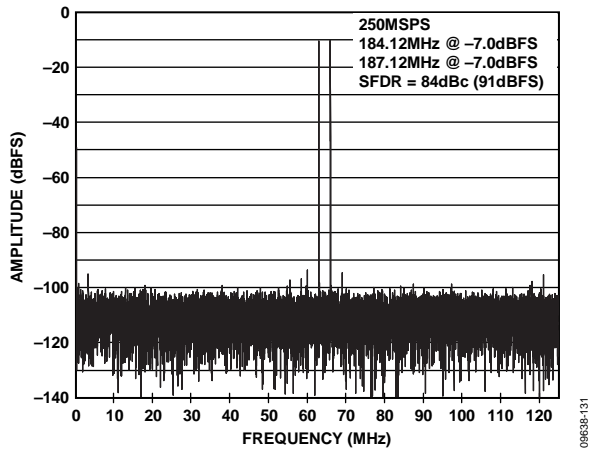

Figure 31. AD6643-250 Two Tone FFT with $f_{IN1} = 184.12$ MHz, $f_{IN2} = 187.12$ MHz

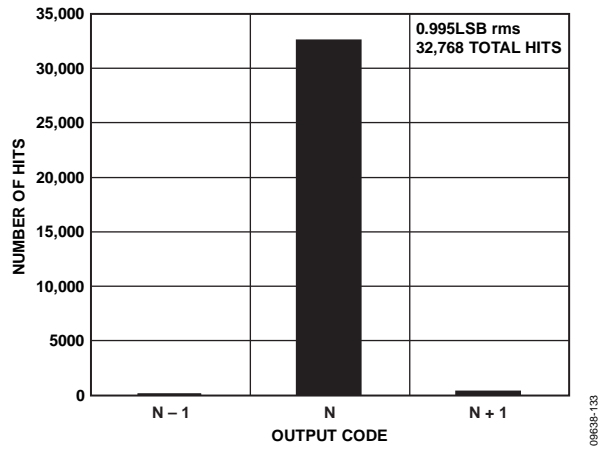

Figure 33. AD6643-250 Grounded Input Histogram

EQUIVALENT CIRCUITS

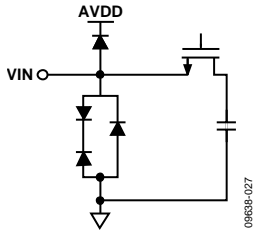

Figure 34. Equivalent Analog Input Circuit

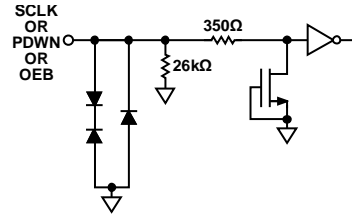

Figure 38. Equivalent SCLK or PDWN or OEB Input Circuit

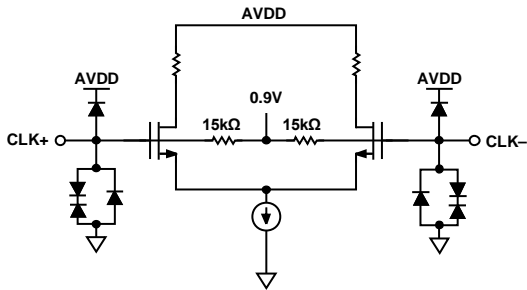

Figure 35. Equivalent Clock Input Circuit

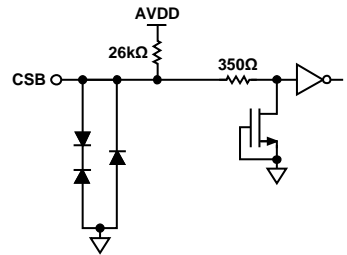

Figure 39. Equivalent CSB Input Circuit

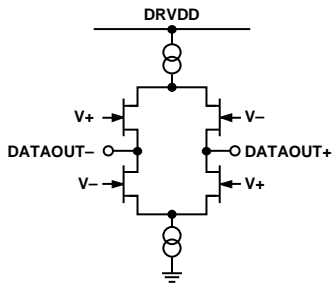

Figure 36. Equivalent LVDS Output Circuit

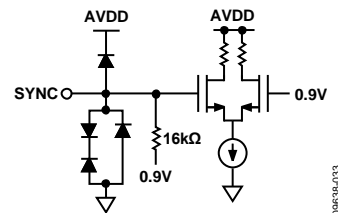

Figure 40. Equivalent SYNC Input Circuit

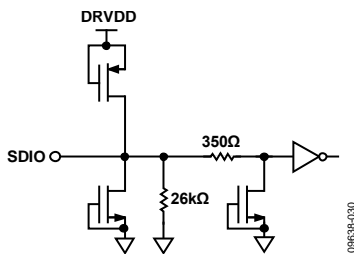

Figure 37. Equivalent SDIO Circuit

THEORY OF OPERATION

The AD6643 has two analog input channels and two digital output channels. The intermediate frequency (IF) input signal passes through several stages before appearing at the output port(s).

ADC ARCHITECTURE

The AD6643 architecture consists of dual front-end sample-and-hold circuits, followed by pipelined, switched capacitor ADCs. The quantized outputs from each stage are combined into a final 11-bit result in the digital correction logic. Alternately, the 11-bit result can be processed through the noise shaping requantizer (NSR) block before it is sent to the digital correction logic.

The pipelined architecture permits the first stage to operate on a new input sample and the remaining stages to operate on the preceding samples. Sampling occurs on the rising edge of the clock.

Each stage of the pipeline, excluding the last, consists of a low resolution flash ADC connected to a switched capacitor digital-to-analog converter (DAC) and an interstage residue amplifier (MDAC). The residue amplifier magnifies the difference between the reconstructed DAC output and the flash input for the next stage in the pipeline. One bit of redundancy is used in each stage to facilitate digital correction of flash errors. The last stage simply consists of a flash ADC.

The input stage of each channel contains a differential sampling circuit that can be ac- or dc-coupled in differential or single-ended modes. The output staging block aligns the data, corrects errors, and passes the data to the output buffers. The output buffers are powered from a separate supply, allowing adjustment of the output drive current. During power-down, the output buffers enter a high impedance state.

The AD6643 dual IF receiver can simultaneously digitize two channels, making it ideal for diversity reception and digital pre-distortion (DPD) observation paths in telecommunication systems.

The dual IF receiver design can be used for diversity reception of signals, whereas the ADCs operate identically on the same carrier but from two separate antennae. The ADCs can also be operated with independent analog inputs. The user can input frequencies from dc to 300 MHz using appropriate low-pass or band-pass filtering at the ADC inputs with little loss in performance. Operation to 400 MHz analog input is permitted but occurs at the expense of increased ADC noise and distortion.

Synchronization capability is provided to allow synchronized timing between multiple devices.

Programming and control of the AD6643 are accomplished using a 3-wire SPI-compatible serial interface.

ANALOG INPUT CONSIDERATIONS

The analog input to the AD6643 is a differential switched capacitor circuit designed for optimum performance in differential signal processing.

The clock signal alternatively switches the input between sample mode and hold mode (see Figure 41). When the input is switched into sample mode, the signal source must be capable of charging the sample capacitors and settling within 1/2 of a clock cycle.

A small resistor in series with each input can help reduce the peak transient current required from the output stage of the driving source. A shunt capacitor can be placed across the inputs to provide dynamic charging currents. This passive network creates a low-pass filter at the ADC input; therefore, the precise values are dependent on the application.

In intermediate frequency (IF) undersampling applications, any shunt capacitors placed across the inputs should be reduced. In combination with the driving source impedance, the shunt capacitors limit the input bandwidth. For more information, refer to the AN-742 Application Note, *Frequency Domain Response of Switched-Capacitor ADCs*; the AN-827 Application Note, *A Resonant Approach to Interfacing Amplifiers to Switched-Capacitor ADCs*; and the *Analog Dialogue* article, "Transformer-Coupled Front-End for Wideband A/D Converters," available at www.analog.com.

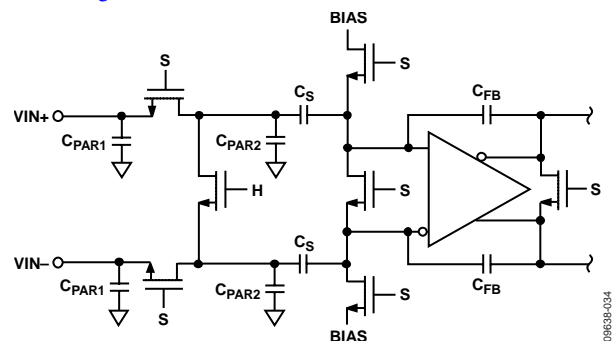

Figure 41. Switched Capacitor Input

For best dynamic performance, match the source impedances driving VIN+ and VIN- and differentially balance the inputs.

Input Common Mode

The analog inputs of the AD6643 are not internally dc biased. In ac-coupled applications, the user must provide this bias externally. Setting the device so that $V_{CM} = 0.5 \times AVDD$ (or $0.9 V$) is recommended for optimum performance.

An on-board common-mode voltage reference is included in the design and is available from the VCM pin. Using the VCM output to set the input common mode is recommended. Optimum performance is achieved when the common-mode voltage of the analog input is set by the VCM pin voltage (typically $0.5 \times AVDD$). The VCM pin must be decoupled to ground by a $0.1 \mu F$ capacitor, as described in the Applications Information section. Place this

decoupling capacitor close to the VCM pin to minimize series resistance and inductance between the device and this capacitor.

Differential Input Configurations

Optimum performance is achieved by driving the AD6643 in a differential input configuration. For baseband applications, the [AD8138](#), [ADA4937-2](#), [ADA4930-2](#), and [ADA4938-2](#) differential drivers provide excellent performance and a flexible interface to the ADC.

The output common-mode voltage of the [ADA4938-2](#) is easily set with the VCM pin of the AD6643 (see Figure 42), and the driver can be configured in a Sallen-Key filter topology to provide band limiting of the input signal.

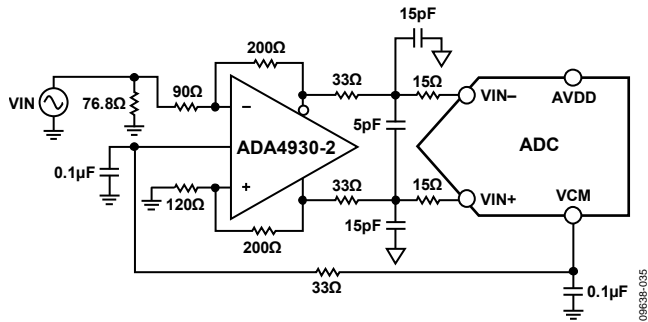

Figure 42. Differential Input Configuration Using the ADA4930-2

For baseband applications where SNR is a key parameter, differential transformer coupling is the recommended input configuration, as shown in Figure 43. To bias the analog input, the VCM voltage can be connected to the center tap of the secondary winding of the transformer.

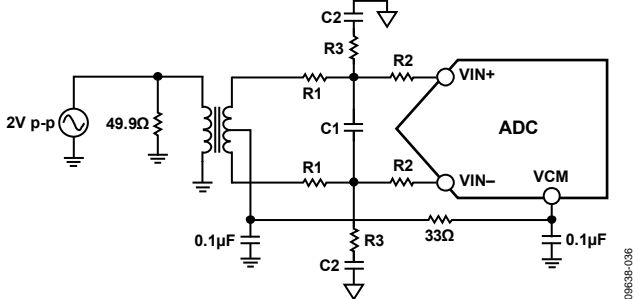

Figure 43. Differential Transformer-Coupled Configuration

The signal characteristics must be considered when selecting a transformer. Most RF transformers saturate at frequencies below a few megahertz (MHz). Excessive signal power can also cause core saturation, which leads to distortion.

At input frequencies in the second Nyquist zone and above, the noise performance of most amplifiers is not adequate to achieve the true SNR performance of the AD6643. For applications where SNR is a key parameter, differential double balun coupling is the recommended input configuration (see Figure 44). In this configuration, the input is ac-coupled, and the CML is provided to each input through a 33 Ω resistor. These resistors compensate for losses in the input baluns to provide a 50 Ω impedance to the driver.

In the double balun and transformer configurations, the value of the input capacitors and resistors is dependent on the input frequency and source impedance. Based on these parameters the value of the input resistors and capacitors may need to be adjusted, or some components may need to be removed. Table 10 lists recommended values to set the RC network for different input frequency ranges. However, because these values are dependent on the input signal and bandwidth, they are to be used as a starting guide only. Note that the values given in Table 10 are for each R1, R2, C2, and R3 component shown in Figure 43 and Figure 44.

Table 10. Example RC Network

Frequency Range (MHz)	R1 Series (Ω)	C1 Differential (pF)	R2 Series (Ω)	C2 Shunt (pF)	R3 Shunt (Ω)
0 to 100	33	8.2	0	15	49.9
100 to 300	15	3.9	0	8.2	49.9

An alternative to using a transformer-coupled input at frequencies in the second Nyquist zone is to use an amplifier with variable gain. The [AD8375](#) or [AD8376](#) digital variable gain amplifiers (DVGAs) provide good performance for driving the AD6643. Figure 45 shows an example of the [AD8376](#) driving the AD6643 through a band-pass antialiasing filter.

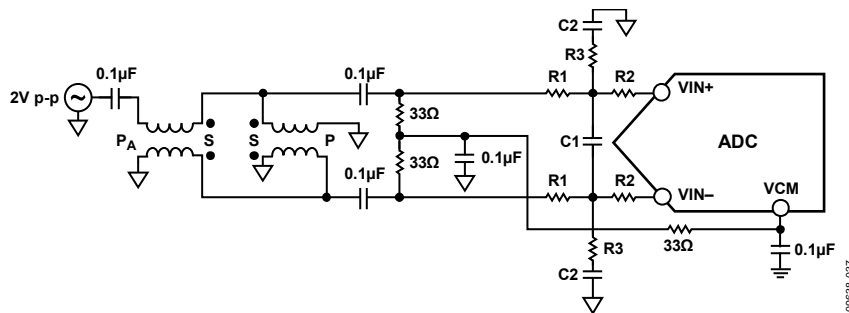
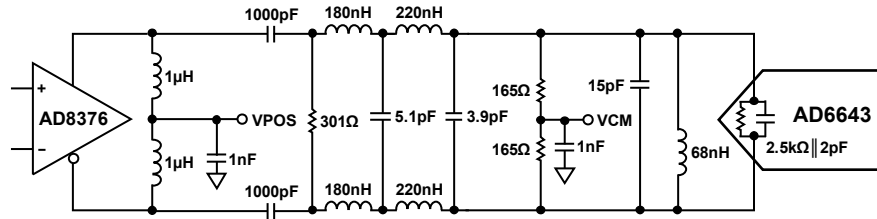

Figure 44. Differential Double Balun Input Configuration



- NOTES
1. ALL INDUCTORS ARE COILCRAFT 0603CS COMPONENTS WITH THE EXCEPTION OF THE 1μH CHOKE INDUCTORS (0603LS).
 2. FILTER VALUES SHOWN ARE FOR A 20MHz BANDWIDTH FILTER CENTERED AT 140MHz.

Figure 45. Differential Input Configuration Using the AD8376

VOLTAGE REFERENCE

A stable and accurate voltage reference is built into the AD6643. The full-scale input range can be adjusted by varying the reference voltage via the SPI. The input span of the ADC tracks reference voltage changes linearly.

CLOCK INPUT CONSIDERATIONS

For optimum performance, clock the AD6643 sample clock inputs (CLK+ and CLK-) by using a differential signal. The signal is typically ac-coupled into the CLK+ and CLK- pins via a transformer or capacitors. These pins are biased internally (see Figure 46) and require no external bias. If the inputs are floated, the CLK- pin is pulled low to prevent spurious clocking.

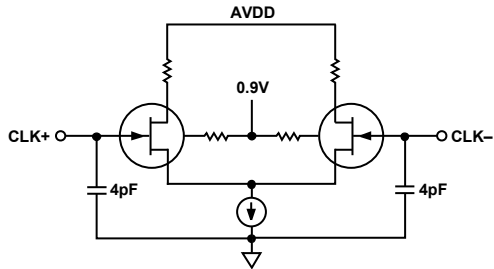

Figure 46. Equivalent Clock Input Circuit

Clock Input Options

The AD6643 has a very flexible clock input structure. Clock input can be a CMOS, LVDS, LVPECL, or sine wave signal. Regardless of the type of signal being used, clock source jitter is the most concern, as described in the Jitter Considerations section.

Figure 47 and Figure 48 show two preferred methods for clocking the AD6643 (at clock rates of up to 625 MHz). A low jitter clock source is converted from a single-ended signal to a differential signal using an RF balun or RF transformer.

The RF balun configuration is recommended for clock frequencies between 125 MHz and 625 MHz, and the RF transformer is recommended for clock frequencies from 10 MHz to 200 MHz. The back-to-back Schottky diodes across the transformer secondary limit clock excursions into the AD6643 to approximately 0.8 V p-p differential. This limit helps prevent the large voltage swings of the

clock from feeding through to other portions of the AD6643, yet preserves the fast rise and fall times of the signal, which are critical to low jitter performance.

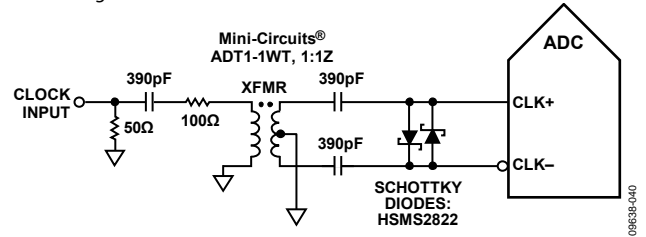

Figure 47. Transformer-Coupled Differential Clock (Up to 200 MHz)

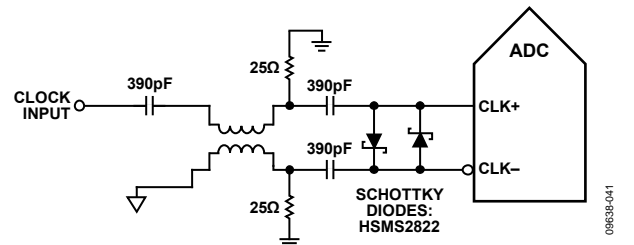

Figure 48. Balun-Coupled Differential Clock (Up to 625 MHz)

If a low jitter clock source is not available, another option is to ac couple a differential PECL signal to the sample clock input pins, as shown in Figure 49. The AD9510, AD9511, AD9512, AD9513, AD9514, AD9515, AD9516-0 to AD9516-5, AD9517-0 to AD9517-4, AD9518-0 to AD9518-4, AD9520-0 to AD9520-5, AD9522-0 to AD9522-5, and the ADCLK905/ADCLK907/ADCLK925 clock drivers offer excellent jitter performance.

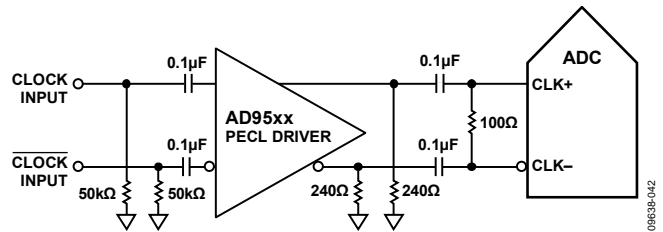

Figure 49. Differential PECL Sample Clock (Up to 625 MHz)

A third option is to ac couple a differential LVDS signal to the sample clock input pins, as shown in Figure 50. The AD9510, AD9511, AD9512, AD9513, AD9514, AD9515, AD9516-0 to AD9516-5, AD9517-0 to AD9517-4, AD9518-0 to AD9518-4, AD9520-0 to AD9520-5, AD9522-0 to AD9522-5, AD9523, and AD9524 clock drivers offer excellent jitter performance.

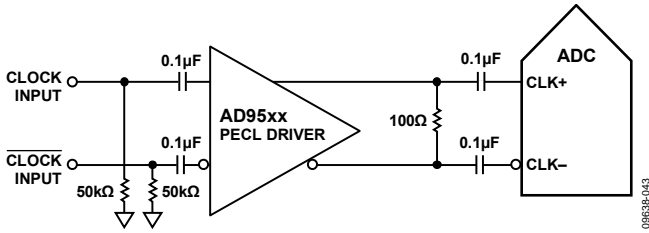

Figure 50. Differential LVDS Sample Clock (Up to 625 MHz)

Input Clock Divider

The AD6643 contains an input clock divider with the ability to divide the input clock by integer values between 1 and 8. The duty cycle stabilizer (DCS) is enabled by default on power-up.

The AD6643 clock divider can be synchronized using the external SYNC input. Bit 1 and Bit 2 of Register 0x3A allow the clock divider to be resynchronized on every SYNC signal or only on the first SYNC signal after the register is written. A valid SYNC causes the clock divider to reset to its initial state. This synchronization feature allows multiple parts to have their clock dividers aligned to guarantee simultaneous input sampling.

Clock Duty Cycle

Typical high speed ADCs use both clock edges to generate a variety of internal timing signals and, as a result, may be sensitive to clock duty cycle. Commonly, a ±5% tolerance is required on the clock duty cycle to maintain dynamic performance characteristics.

The AD6643 contains a duty cycle stabilizer (DCS) that retimes the nonsampling (falling) edge, thereby providing an internal clock signal with a nominal 50% duty cycle. This allows the user to provide a wide range of clock input duty cycles without affecting the performance of the AD6643.

Jitter on the rising edge of the input clock is of paramount concern and is not reduced by the duty cycle stabilizer. The duty cycle control loop does not function for clock rates of less than 40 MHz nominally. The loop has a time constant associated with it that must be considered when the clock rate can change dynamically. A wait time of 1.5 µs to 5 µs is required after a dynamic clock frequency increase or decrease before the DCS loop is relocked to the input signal. During the time period that the loop is not locked, the DCS loop is bypassed, and internal device timing is dependent on the duty cycle of the input clock signal. In such applications, it may be appropriate to disable the DCS. In all other applications, enabling the DCS circuit is recommended to maximize ac performance.

Jitter Considerations

High speed, high resolution ADCs are sensitive to the quality of the clock input. The degradation in SNR at a given input frequency (f_{IN}) due to jitter (t_j) can be calculated by

$$SNR_{HF} = -10 \log[(2\pi \times f_{IN} \times t_{jRMS})^2 + 10^{(-SNR_{LF}/10)}]$$

In the equation, the rms aperture jitter represents the root mean square of all jitter sources, which include the clock input, the analog input signal, and the ADC aperture jitter specification. IF

undersampling applications are particularly sensitive to jitter, as shown in Figure 51.

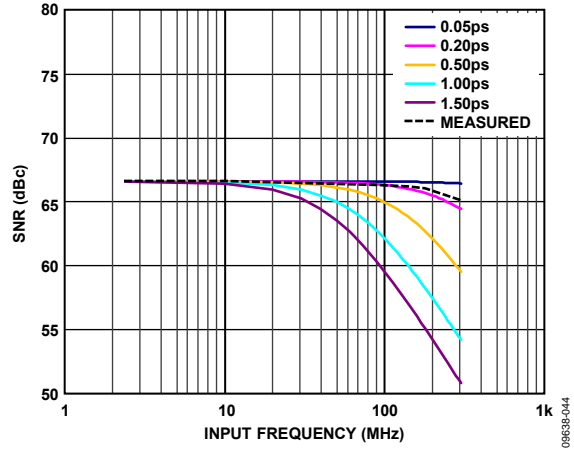

Figure 51. SNR vs. Input Frequency and Jitter

In cases where aperture jitter may affect the dynamic range of the AD6643, treat the clock input as an analog signal. Separate power supplies for clock drivers from the ADC output driver supplies to avoid modulating the clock signal with digital noise. Low jitter, crystal controlled oscillators make the best clock sources. If the clock is generated from another type of source (by gating, dividing, or another method), it should be retimed by the original clock at the last step.

Refer to the AN-501 Application Note, Aperture Uncertainty and ADC System Performance, and the AN-756 Application Note, Sample Systems and the Effects of Clock Phase Noise and Jitter, for more information about jitter performance as it relates to ADCs (see www.analog.com).

POWER DISSIPATION AND STANDBY MODE

As shown in Figure 52, the power dissipated by the AD6643 is proportional to its sample rate. The data in Figure 52 was taken using the same operating conditions as those used for the Typical Performance Characteristics.

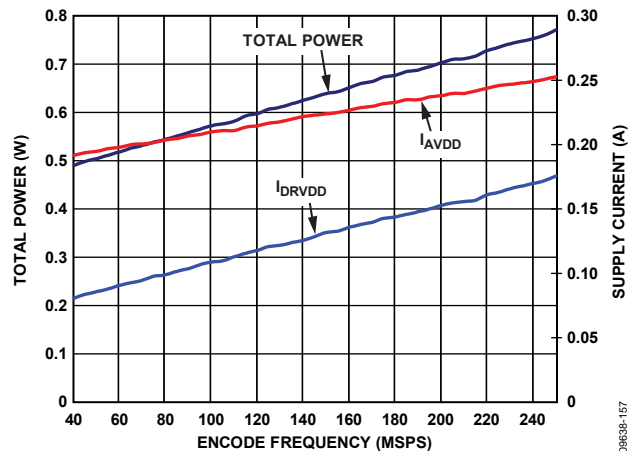

Figure 52. AD6643 Power and Current vs. Sample Rate

By asserting PDWN (either through the SPI port or by asserting the PDWN pin high), the AD6643 is placed in power-down mode. In this state, the ADC typically dissipates 10 mW. During

power-down, the output drivers are placed in a high impedance state. Asserting the PDWN pin low returns the AD6643 to its normal operating mode. Note that PDWN is referenced to the digital output driver supply (DRVDD) and should not exceed that supply voltage.

Low power dissipation in power-down mode is achieved by shutting down the reference, reference buffer, biasing networks, and clock. Internal capacitors are discharged when entering power-down mode and then must be recharged when returning to normal operation. As a result, wake-up time is related to the time spent in power-down mode, and shorter power-down cycles result in proportionally shorter wake-up times.

When using the SPI port interface, the user can place the ADC in power-down mode or standby mode. Standby mode allows the user to keep the internal reference circuitry powered when faster wake-up times are required. See the Memory Map Register Description section and the [AN-877 Application Note, Interfacing to High Speed ADCs via SPI](#), available at www.analog.com for additional details.

DIGITAL OUTPUTS

The AD6643 output drivers can be configured for either ANSI LVDS or reduced drive LVDS using a 1.8 V DRVDD supply.

As detailed in the [AN-877 Application Note, Interfacing to High Speed ADCs via SPI](#), the data format can be selected for offset binary, twos complement, or gray code when using the SPI control.

Digital Output Enable Function (OEB)

The AD6643 has a flexible three-state ability for the digital output pins. The three-state mode is enabled using the OEB pin or through the SPI interface. If the OEB pin is low, the output data drivers are enabled. If the OEB pin is high, the output data drivers are placed in a high impedance state. This OEB function

is not intended for rapid access to the data bus. Note that OEB is referenced to the digital output driver supply (DRVDD) and should not exceed that supply voltage.

When using the SPI interface, the data outputs of each channel can be independently three-stated by using the output disable bar bit (Bit 4) in Register 0x14. Because the output data is interleaved, if only one of the two channels is disabled, the data from the remaining channel is repeated in both the rising and falling output clock cycles.

Timing

The AD6643 provides latched data with a pipeline delay of 10 input sample clock cycles (13 input sample clock cycles when NSR is enabled). Data outputs are available one propagation delay (t_{PD}) after the rising edge of the clock signal.

To reduce transients within the AD6643, minimize the length of the output data lines and loads that are placed on them. These transients can degrade converter dynamic performance.

The lowest typical conversion rate of the AD6643 is 40 MSPS. At clock rates below 40 MSPS, dynamic performance can degrade.

Data Clock Output (DCO)

The AD6643 also provides data clock output (DCO) intended for capturing the data in an external register. Figure 2 shows a graphical timing diagram of the AD6643 output modes.

ADC OVERRANGE (OR)

The ADC overrange indicator is asserted when an overrange is detected on the input of the ADC. The overrange condition is determined at the output of the ADC pipeline and, therefore, is subject to a latency of 10 ADC clock cycles (13 ADC clock cycles with NSR enabled). An overrange at the input is indicated by this bit 10 clock cycles after it occurs (13 clock cycles with NSR enabled).

Table 11. Output Data Format

Input (V)	VIN+ – VIN–, Input Span = 1.75 V p-p (V)	Offset Binary Output Mode	Twos Complement Mode (Default)	OR
VIN+ – VIN–	Less than –0.875	000 0000 0000	100 0000 0000	1
VIN+ – VIN–	–0.875	000 0000 0000	100 0000 0000	0
VIN+ – VIN–	0	100 0000 0000	000 0000 0000	0
VIN+ – VIN–	+ 0.875	111 1111 1111	011 1111 1111	0
VIN+ – VIN–	Greater than + 0.875	111 1111 1111	011 1111 1111	1

NOISE SHAPING REQUANTIZER (NSR)

The AD6643 features a noise shaping requantizer (NSR) to allow higher than 11-bit SNR to be maintained in a subset of the Nyquist band. The harmonic performance of the receiver is unaffected by the NSR feature. When enabled, the NSR contributes an additional 0.6 dB of loss to the input signal, such that a 0 dBFS input is reduced to -0.6 dBFS at the output pins.

The NSR feature can be independently controlled per channel via the SPI.

Two different bandwidth modes are provided; the mode can be selected from the SPI port. In each of the two modes, the center frequency of the band can be tuned such that IFs can be placed anywhere in the Nyquist band.

22% BW MODE (>40 MHz AT 184.32 MSPS)

The first bandwidth mode offers excellent noise performance over 22% of the ADC sample rate (44% of the Nyquist band) and can be centered by setting the NSR mode bits in the NSR control register (Address 0x3C) to 000. In this mode, the useful frequency range can be set using the 6-bit tuning word in the NSR tuning register (Address 0x3E). There are 57 possible tuning words (TW); each step is 0.5% of the ADC sample rate. The following three equations describe the left band edge (f_0), the channel center (f_{CENTER}), and the right band edge (f_1), respectively:

$$f_0 = f_{ADC} \times .005 \times TW$$

$$f_{CENTER} = f_0 + 0.11 \times f_{ADC}$$

$$f_1 = f_0 + 0.22 \times f_{ADC}$$

Figure 53 to Figure 55 show the typical spectrum that can be expected from the AD6643 in the 22% BW mode for three different tuning words.

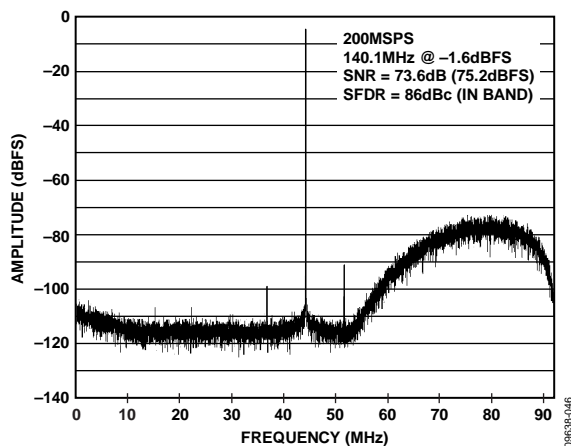

Figure 53. 22% BW Mode, Tuning Word = 13

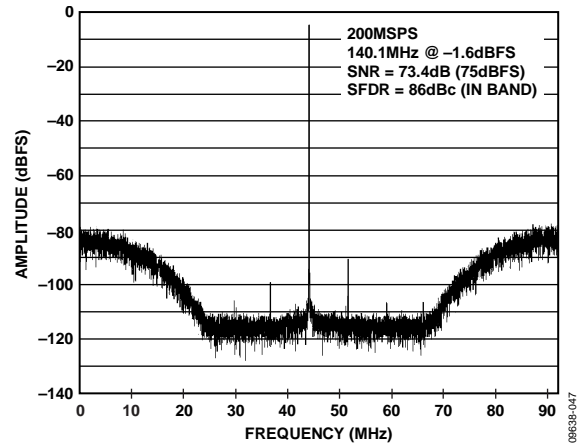

Figure 54. 22% BW Mode, Tuning Word = 28 ($f_s/4$ Tuning)

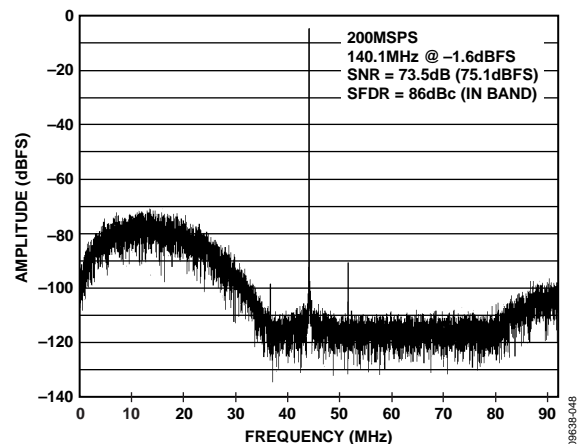

Figure 55. 22% BW Mode, Tuning Word = 41

33% BW MODE (>60 MHz AT 184.32 MSPS)

The second bandwidth mode offers excellent noise performance over 33% of the ADC sample rate (66% of the Nyquist band) and can be centered by setting the NSR mode bits in the NSR control register (Address 0x3C) to 001. In this mode, the useful frequency range can be set using the 6-bit tuning word in the NSR tuning register (Address 0x3E). There are 34 possible tuning words (TW); each step is 0.5% of the ADC sample rate. The following three equations describe the left band edge (f_0), the channel center (f_{CENTER}), and the right band edge (f_1), respectively:

$$f_0 = f_{ADC} \times .005 \times TW$$

$$f_{CENTER} = f_0 + 0.165 \times f_{ADC}$$

$$f_1 = f_0 + 0.33 \times f_{ADC}$$

Figure 56 to Figure 58 show the typical spectrum that can be expected from the AD6643 in the 33% BW mode for three different tuning words.

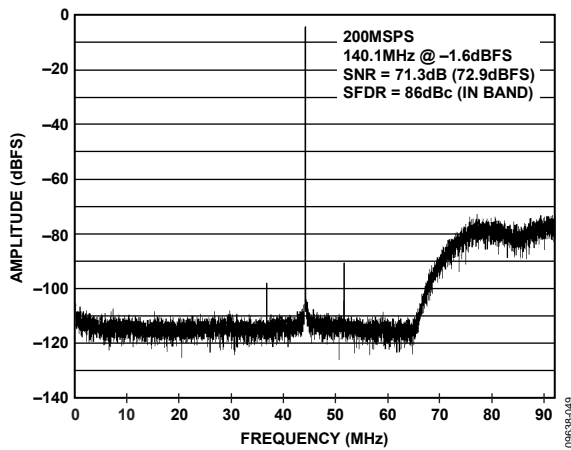

Figure 56. 33% BW Mode, Tuning Word = 5

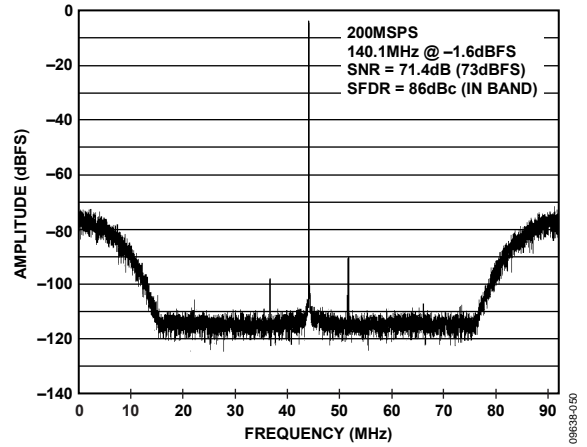

Figure 57. 33% BW Mode, Tuning Word = 17 ($f_s/4$ Tuning)

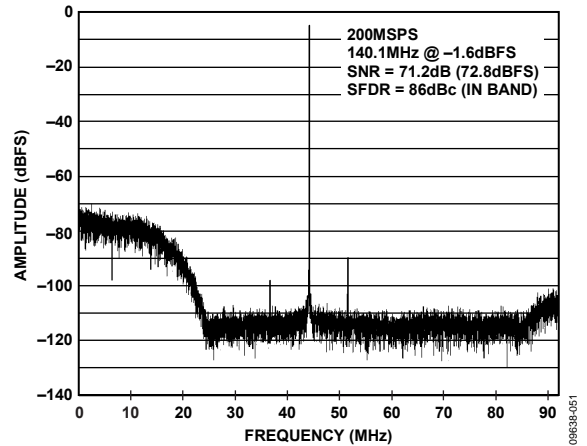

Figure 58. 33% BW Mode, Tuning Word = 27

CHANNEL/CHIP SYNCHRONIZATION

The AD6643 has a SYNC input that allows the user flexible synchronization options for synchronizing the internal blocks. The sync feature is useful for guaranteeing synchronized operation across multiple ADCs. The input clock divider can be synchronized using the SYNC input. The divider can be enabled to synchronize on a single occurrence of the SYNC signal or on every occurrence by setting the appropriate bits in Register 0x3A.

The SYNC input is internally synchronized to the sample clock. However, to ensure that there is no timing uncertainty between multiple parts, synchronize the SYNC input signal to the input clock signal. Drive the SYNC input using a single-ended CMOS type signal.

SERIAL PORT INTERFACE (SPI)

The AD6643 serial port interface (SPI) allows the user to configure the converter for specific functions or operations through a structured register space provided inside the ADC. The SPI gives the user added flexibility and customization, depending on the application. Addresses are accessed via the serial port and can be written to or read from via the port. Memory is organized into bytes that can be further divided into fields. These fields are documented in the Memory Map section. For detailed operational information, see the [AN-877](#) Application Note, *Interfacing to High Speed ADCs via SPI*.

CONFIGURATION USING THE SPI

Three pins define the SPI of this ADC: the SCLK pin, the SDIO pin, and the CSB pin (see Table 12). The SCLK (serial clock) pin is used to synchronize the read and write data presented from/to the ADC. The SDIO (serial data input/output) pin is a dual purpose pin that allows data to be sent and read from the internal ADC memory map registers. The CSB (chip select bar) pin is an active low control that enables or disables the read and write cycles.

Table 12. Serial Port Interface Pins

Pin	Function
SCLK	Serial clock. The serial shift clock input, which is used to synchronize serial interface reads and writes.
SDIO	Serial data input/output. A dual purpose pin that typically serves as an input or an output, depending on the instruction being sent and the relative position in the timing frame.
CSB	Chip select bar. An active low control that gates the read and write cycles.

The falling edge of the CSB, in conjunction with the rising edge of the SCLK, determines the start of the framing. An example of the serial timing and its definitions can be found in Figure 59 and Table 5.

Other modes involving the CSB are available. The CSB can be held low indefinitely, which permanently enables the device; this is called streaming. The CSB can stall high between bytes to allow for additional external timing. When CSB is tied high, SPI functions are placed in a high impedance mode. This mode turns on any SPI pin secondary functions.

During an instruction phase, a 16-bit instruction is transmitted. Data follows the instruction phase, and its length is determined by the W0 bit and the W1 bit.

All data is composed of 8-bit words. The first bit of each individual byte of serial data indicates whether a read or write command is issued. This allows the serial data input/output (SDIO) pin to change direction from an input to an output.

In addition to word length, the instruction phase determines whether the serial frame is a read or write operation, allowing the serial port to be used both to program the chip and to read the contents of the on-chip memory. If the instruction is a readback operation, performing a readback causes the serial data input/output (SDIO) pin to change direction from an input to an output at the appropriate point in the serial frame.

Data can be sent in MSB-first mode or in LSB-first mode. MSB first is the default on power-up and can be changed via the SPI port configuration register. For more information about this and other features, see the [AN-877](#) Application Note, *Interfacing to High Speed ADCs via SPI*, available at www.analog.com.

HARDWARE INTERFACE

The pins described in Table 12 comprise the physical interface between the user's programming device and the serial port of the AD6643. Both the SCLK pin and the CSB pin function as inputs when using the SPI interface. The SDIO pin is bidirectional, functioning as an input during write phases and as an output during readback.

The SPI interface is flexible enough to be controlled by either FPGAs or microcontrollers. One method for SPI configuration is described in detail in the [AN-812](#) Application Note, *Microcontroller-Based Serial Port Interface (SPI) Boot Circuit*.

The SPI port should not be active during periods when the full dynamic performance of the converter is required. Because the SCLK signal, the CSB signal, and the SDIO signal are typically asynchronous to the ADC clock, noise from these signals can degrade converter performance. If the on-board SPI bus is used for other devices, it may be necessary to provide buffers between this bus and the AD6643 to prevent these signals from transitioning at the converter inputs during critical sampling periods.

Some pins serve a dual function when the SPI interface is not being used. When the pins are strapped to AVDD or ground during device power-on, they are associated with a specific function. The Digital Outputs section describes the strappable functions supported on the AD6643.

SPI ACCESSIBLE FEATURES

Table 13 provides a brief description of the general features that are accessible via the SPI. These features are described in detail in the AN-877 Application Note, *Interfacing to High Speed ADCs via SPI* (available at www.analog.com). The AD6643 part-specific features are described in the Memory Map Register Description section.

Table 13. Features Accessible Using the SPI

Feature Name	Description
Power Mode	Allows the user to set either power-down mode or standby mode
Clock	Allows the user to access the DCS via the SPI
Offset	Allows the user to digitally adjust the converter offset
Test I/O	Allows the user to set test modes to have known data on output bits
Output Mode	Allows the user to set up outputs
Output Phase	Allows the user to set the output clock polarity
Output Delay	Allows the user to vary the DCO delay
VREF	Allows the user to set the reference voltage
Digital Processing	Allows the user to enable the synchronization features

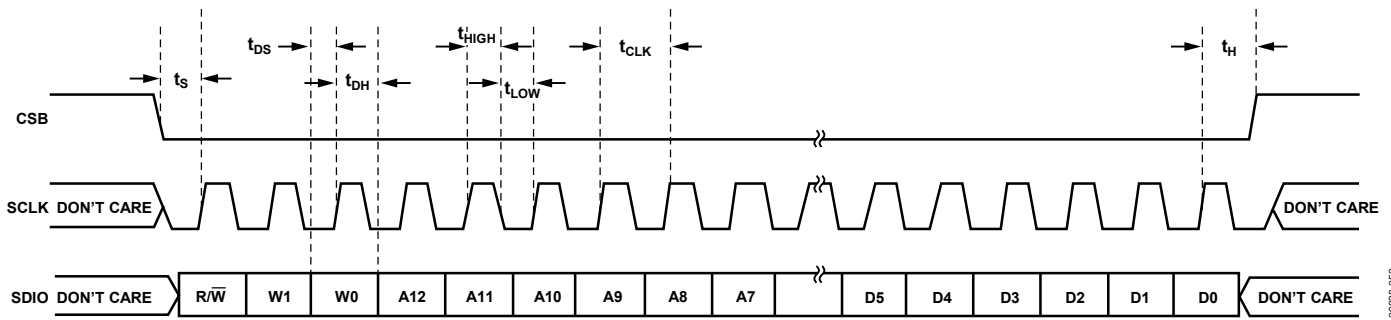

Figure 59. Serial Port Interface Timing Diagram

09638F-052

MEMORY MAP

READING THE MEMORY MAP REGISTER TABLE

Each row in the memory map register table has eight bit locations. The memory map is roughly divided into four sections: the chip configuration registers (Address 0x00 to Address 0x02); the channel index and transfer registers (Address 0x05 and Address 0xFF); the ADC functions registers, including setup, control, and test (Address 0x08 to Address 0x20); and the digital feature control registers (Address 0x3A to Address 0x3E).

The memory map register table (see Table 14) documents the default hexadecimal value for each hexadecimal address listed. The column with the heading Bit 7 (MSB) is the start of the default hexadecimal value given. For example, Address 0x14, the output mode register, has a hexadecimal default value of 0x05. This means that Bit 0 = 1, and the remaining bits are 0s. This setting is the default output format value, which is twos complement. For more information on this function and others, see the [AN-877](#) Application Note, *Interfacing to High Speed ADCs via SPI*. This document details the functions controlled by Register 0x00 to Register 0x20. The remaining registers, from Register 0x3A to Register 0x3E, are documented in the Memory Map Register Description section.

Open Locations

All address and bit locations that are not included in Table 14 are not currently supported for this device. Unused bits of a valid address location should be written with 0s. Writing to these locations is required only when part of an address location is open (for example, Address 0x18). If the entire address location is open (for example, Address 0x13), this address location should not be written.

Default Values

After the AD6643 is reset, critical registers are loaded with default values. The default values for the registers are given in the memory map register table, Table 14.

Logic Levels

An explanation of logic level terminology follows:

- “Bit is set” is synonymous with “bit is set to Logic 1” or “writing Logic 1 for the bit.”
- “Clear a bit” is synonymous with “bit is set to Logic 0” or “writing Logic 0 for the bit.”

Transfer Register Map

Address 0x08 to Address 0x20, and Address 0x3A to Address 0x3E are shadowed. Writes to these addresses do not affect device operation until a transfer command is issued by writing 0x01 to Address 0xFF, setting the transfer bit. This allows these registers to be updated internally and simultaneously when the transfer bit is set. The internal update takes place when the transfer bit is set, and then the bit autoclears.

Channel Specific Registers

Some channel setup functions, such as the signal monitor thresholds, can be programmed to a different value for each channel. In these cases, channel address locations are internally duplicated for each channel. These registers and bits are designated in Table 14 as local. These local registers and bits can be accessed by setting the appropriate Channel A or Channel B bits in Register 0x05.

If both bits are set, the subsequent write affects the registers of both channels. In a read cycle, only Channel A or Channel B should be set to read one of the two registers. If both bits are set during an SPI read cycle, the part returns the value for Channel A.

Registers and bits designated as global in Table 14 affect the entire device or the channel features where independent settings are not allowed between channels. The settings in Register 0x05 do not affect the global registers and bits.

MEMORY MAP REGISTER TABLE

All address and bit locations that are not included in Table 14 are not currently supported for this device.

Table 14. Memory Map Registers

Addr (Hex)	Register Name	Bit 7 (MSB)	Bit 6	Bit 5	Bit 4	Bit 3	Bit 2	Bit 1	Bit 0 (LSB)	Default Value (Hex)	Default Notes/Comments
Chip Configuration Registers											
0x00	SPI port configuration (global) ¹	0	LSB first	Soft reset	1	1	Soft reset	LSB first	0	0x18	The nibbles are mirrored so LSB-first mode or MSB-first mode registers correctly, regardless of shift mode
0x01	Chip ID (global)	8-Bit Chip ID[7:0] (AD6643 = 0x84) (default)								0x84	Read only
0x02	Chip grade (global)	Open	Open	Speed grade ID 00 = 250 MSPS 10 = 200 MSPS	Open	Open	Open	Open	Open		Speed grade ID used to differentiate devices; read only
Channel Index and Transfer Registers											
0x05	Channel index (global)	Open	Open	Open	Open	Open	Open	ADC B (default)	ADC A (default)	0x03	Bits are set to determine which device on the chip receives the next write command; applies to local registers only
0xFF	Transfer (global)	Open	Open	Open	Open	Open	Open	Open	Transfer	0x00	Synchronously transfers data from the master shift register to the slave
ADC Functions											
0x08	Power modes (local)	Open	Open	External power-down pin function (local) 0 = power-down 1 = standby	Open	Open	Open	Internal power-down mode (local) 00 = normal operation 01 = full power-down 10 = standby 11 = reserved		0x00	Determines various generic modes of chip operation
0x09	Global clock (global)	Open	Open	Open	Open	Open	Open	Open	Duty cycle stabilizer (default)	0x01	
0x0B	Clock divide (global)	Open	Open	Input clock divider phase adjust 000 = no delay 001 = 1 input clock cycle 010 = 2 input clock cycles 011 = 3 input clock cycles 100 = 4 input clock cycles 101 = 5 input clock cycles 110 = 6 input clock cycles 111 = 7 input clock cycles			Clock divide ratio 000 = divide by 1 001 = divide by 2 010 = divide by 3 011 = divide by 4 100 = divide by 5 101 = divide by 6 110 = divide by 7 111 = divide by 8		0x00	Clock divide values other than 000 automatically cause the duty cycle stabilizer to become active	

Addr (Hex)	Register Name	Bit 7 (MSB)	Bit 6	Bit 5	Bit 4	Bit 3	Bit 2	Bit 1	Bit 0 (LSB)	Default Value (Hex)	Default Notes/Comments
0x0D	Test mode (local)	User test mode control 0 = continuous/repeat pattern 1 = single pattern then zeros	Open	Reset PN long gen	Reset PN short gen	Output test mode 0000 = off (default) 0001 = midscale short 0010 = positive FS 0011 = negative FS 0100 = alternating checkerboard 0101 = PN long sequence 0110 = PN short sequence 0111 = one/zero word toggle 1000 = user test mode 1001 to 1110 = unused 1111 = ramp output				0x00	When this register is set, the test data is placed on the output pins in place of normal data
0x10	Offset adjust (local)	Open	Open	Offset adjust in LSBs from +31 to -32 (twos complement format)						0x00	
0x14	Output mode	Open	Open	Open	Output disable (local)	Open	Output invert (local) 1 = normal (default) 0 = inverted	Output format 00 = offset binary 01 = twos complement (default) 10 = gray code 11 = reserved (local)		0x05	Configures the outputs and the format of the data
0x15	Output adjust (global)	Open	Open	Open	Open	LVDS output drive current adjust 0000 = 3.72 mA output drive current 0001 = 3.5 mA output drive current (default) 0010 = 3.30 mA output drive current 0011 = 2.96 mA output drive current 0100 = 2.82 mA output drive current 0101 = 2.57 mA output drive current 0110 = 2.27 mA output drive current 0111 = 2.0 mA output drive current (reduced range) 1000 to 1111 = reserved				0x01	
0x16	Clock phase control (global)	Invert DCO clock	Open	Odd/Even mode output enable 0 = disabled 1 = enabled	Open	Open	Open	Open	Open	0x00	
0x17	DCO output delay (global)	Enable DCO clock delay	Open	Open	DCO clock delay [delay = (3100 ps × register value/31 + 100)] 00000 = 100 ps 00001 = 200 ps 00010 = 300 ps ... 11110 = 3100 ps 11111 = 3200 ps				0x00		
0x18	Input span select (global)	Open	Open	Open	Full-scale input voltage selection 01111 = 2.087 V p-p ... 00001 = 1.772 V p-p 00000 = 1.75 V p-p (default) 11111 = 1.727 V p-p ... 10000 = 1.383 V p-p				0x00	Full-scale input adjustment in 0.022 V steps	
0x19	User Test Pattern 1 LSB (global)	User Test Pattern 1[7:0]								0x00	
0x1A	User Test Pattern 1 MSB (global)	User Test Pattern 1[15:8]								0x00	

Addr (Hex)	Register Name	Bit 7 (MSB)	Bit 6	Bit 5	Bit 4	Bit 3	Bit 2	Bit 1	Bit 0 (LSB)	Default Value (Hex)	Default Notes/Comments	
0x1B	User Test Pattern 2 LSB (global)	User Test Pattern 2[7:0]								0x00		
0x1C	User Test Pattern 2 MSB (global)	User Test Pattern 2[15:8]								0x00		
0x1D	User Test Pattern 3 LSB (global)	User Test Pattern 3[7:0]								0x00		
0x1E	User Test Pattern 3 MSB (global)	User Test Pattern 3[15:8]								0x00		
0x1F	User Test Pattern 4 LSB (global)	User Test Pattern 4[7:0]								0x00		
0x20	User Test Pattern 4 MSB (global)	User Test Pattern 4[15:8]								0x00		
Digital Feature Control Registers												
0x3A	Sync control (global)	Open	Open	Open	Open	Open	Open	Clock divider sync enable 0 = off 1 = on	Master sync enable 0 = off 1 = on	0x00	Control register to synchronize the clock divider	
0x3C	NSR control (local)	Open	Open	Open	Open	NSR mode 000 = 22% BW mode 001 = 33% BW mode			NSR enable 0 = off 1 = on	0x00	Noise shaping requantizer (NSR) controls	
0x3E	NSR tuning word (local)	Open	Open	NSR tuning word See the Noise Shaping Requantizer (NSR) section Equations for the tuning word are dependent on the NSR mode							0x1C	NSR frequency tuning word

¹ The channel index register at Address 0x05 should be set to 0x03 (default) when writing to Address 0x00.

MEMORY MAP REGISTER DESCRIPTION

For more information on functions controlled in Register 0x00 to Register 0x20, see the [AN-877](#) Application Note, *Interfacing to High Speed ADCs via SPI*, available at www.analog.com.

Sync Control (Register 0x3A)

Bits[7:3]—Reserved

Bit 2—Clock Divider Next Sync Only

If the master sync enable buffer bit (Address 0x3A, Bit0) and the clock divider sync enable bit (Address 0x3A, Bit 1) are high, Bit 2 allows the clock divider to sync to the first sync pulse it receives and to ignore the rest. The clock divider sync enable bit (Address 0x3A, Bit 1) resets after it syncs.

Bit 1—Clock Divider Sync Enable

Bit 1 gates the sync pulse to the clock divider. The sync signal is enabled when Bit 1 is high and Bit 0 is high. This is continuous sync mode.

Bit 0—Master Sync Buffer Enable

Bit 0 must be set high to enable any of the sync functions. If the sync capability is not used this bit should remain low to conserve power.

NSR Control (Register 0x3C)

Bits[7:4]—Reserved

Bits[3:1]—NSR Mode

Bits[3:1] determine the bandwidth mode of the NSR. When Bits[3:1] are set to 000, the NSR is configured for a 22% BW mode that provides enhanced SNR performance over 22% of the sample rate. When Bits[3:1] are set to 001, the NSR is configured for a 33% BW mode that provides enhanced SNR performance over 33% of the sample rate.

Bit 0—NSR Enable

The NSR is enabled when Bit 0 is high and disabled when Bit 0 is low.

NSR Tuning Word (Register 0x3E)

Bits[7:6]—Reserved

Bits[5:0]—NSR Tuning Word

The NSR tuning word sets the band edges of the NSR band. In 22% BW mode, there are 57 possible tuning words; in 33% BW mode, there are 34 possible tuning words. For either mode, each step represents 0.5% of the ADC sample rate. For the equations that are used to calculate the tuning word based on the BW mode of operation, see the Noise Shaping Requantizer (NSR) section.

APPLICATIONS INFORMATION

DESIGN GUIDELINES

Before starting system level design and layout of the AD6643, it is recommended that the designer become familiar with these guidelines, which discuss the special circuit connections and layout requirements needed for certain pins.

Power and Ground Recommendations

When connecting power to the AD6643, it is recommended that two separate 1.8 V supplies be used: one supply for analog (AVDD) and a separate supply for the digital outputs (DRVDD). The designer can employ several different decoupling capacitors to cover both high and low frequencies. Locate these capacitors close to the point of entry at the PCB level and close to the pins of the device using minimal trace length.

A single PCB ground plane should be sufficient when using the AD6643. With proper decoupling and smart partitioning of the PCB analog, digital, and clock sections, optimum performance is easily achieved.

Exposed Paddle Thermal Heat Slug Recommendations

It is mandatory that the exposed paddle on the underside of the ADC be connected to analog ground (AGND) to achieve the best electrical and thermal performance. A continuous, exposed (no solder mask) copper plane on the PCB should mate to the AD6643 exposed paddle, Pin 0.

The copper plane should have several vias to achieve the lowest possible resistive thermal path for heat dissipation to flow through the bottom of the PCB. Fill or plug these vias with nonconductive epoxy.

To maximize the coverage and adhesion between the ADC and the PCB, overlay a silkscreen to partition the continuous plane on the PCB into several uniform sections. This provides several tie points between the ADC and the PCB during the reflow process. Using one continuous plane with no partitions guarantees only one tie point between the ADC and the PCB. See the evaluation board for a PCB layout example. For detailed information about packaging and PCB layout of chip scale packages, refer to the [AN-772](#) Application Note, *A Design and Manufacturing Guide for the Lead Frame Chip Scale Package (LFCSP)*.

VCM

Decouple the VCM pin to ground with a 0.1 μF capacitor, as shown in Figure 43. For optimal channel-to-channel isolation, a 33 Ω resistor should be included between the AD6643 VCM pin and the Channel A analog input network connection and between the AD6643 VCM pin and the Channel B analog input network connection.

SPI Port

The SPI port should not be active during periods when the full dynamic performance of the converter is required. Because the SCLK, CSB, and SDIO signals are typically asynchronous to the ADC clock, noise from these signals can degrade converter performance. If the on-board SPI bus is used for other devices, it may be necessary to provide buffers between this bus and the AD6643 to keep these signals from transitioning at the converter inputs during critical sampling periods.

OUTLINE DIMENSIONS

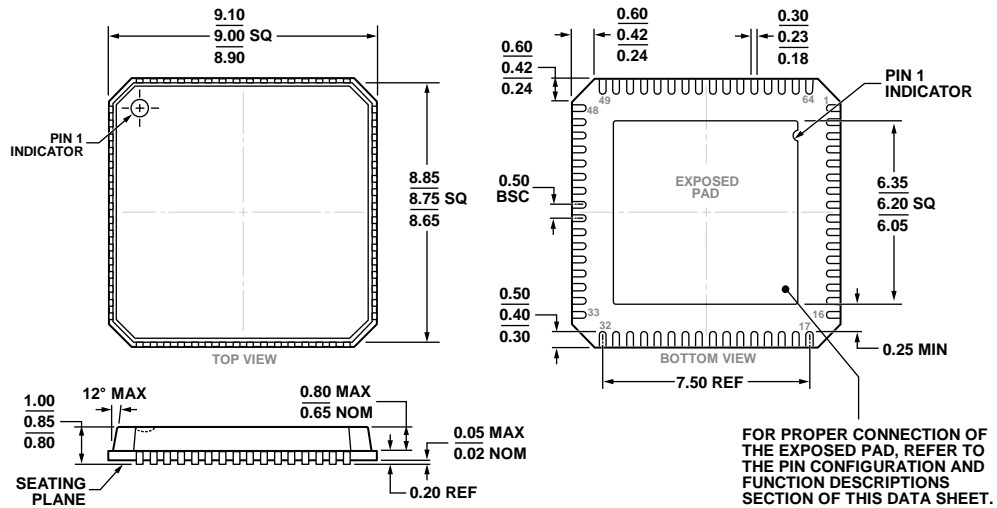

COMPLIANT TO JEDEC STANDARDS MO-220-VMM4
 Figure 60. 64-Lead Lead Frame Chip Scale Package [LFCSQ_VQ]
 9 mm × 9 mm Body, Very Thin Quad
 (CP-64-4)
 Dimensions shown in millimeters

ORDERING GUIDE

Model ¹	Temperature Range	Package Description	Package Option
AD6643BCPZ-200	-40°C to +85°C	64-Lead Lead Frame Chip Scale Package [LFCSQ_VQ]	CP-64-4
AD6643BCPZRL7-200	-40°C to +85°C	64-Lead Lead Frame Chip Scale Package [LFCSQ_VQ]	CP-64-4
AD6643BCPZ-250	-40°C to +85°C	64-Lead Lead Frame Chip Scale Package [LFCSQ_VQ]	CP-64-4
AD6643BCPZRL7-250	-40°C to +85°C	64-Lead Lead Frame Chip Scale Package [LFCSQ_VQ]	CP-64-4

¹ Z = RoHS Compliant Part.

NOTES

NOTES

NOTES

X-ON Electronics

Largest Supplier of Electrical and Electronic Components

Click to view similar products for [RF Receiver](#) category:

Click to view products by [Analog Devices](#) manufacturer:

Other Similar products are found below :

[MICRF011YN](#) [HMC8100LP6JETR](#) [TDA5240](#) [TDA5201XT](#) [TDA5225](#) [ATA8205P6C-TKQW](#) [VRC522](#) [MICRF229YQS](#) [SI4825-A10-CS](#)
[SI4730-D60-GMR](#) [MICRF219AA YQS](#) [AW13412DNR](#) [LT5504EMS8#PBF](#) [AD6677BCPZ](#) [AD6641BCPZ-500](#) [AD6643BCPZ-200](#)
[AD6643BCPZ-250](#) [AD6649BCPZ](#) [AD6649BCPZRL7](#) [AD6650ABC](#) [AD6652BBCZ](#) [AD6655ABCPZ-125](#) [AD6655ABCPZ-150](#)
[AD6655ABCPZ-80](#) [AD6657ABBCZ](#) [AD6657BBCZ](#) [AD6673BCPZ-250](#) [AD6674-1000EBZ](#) [AD6674BCPZ-1000](#) [AD6674BCPZ-500](#)
[AD6676BCBZRL](#) [AD6679BBPZ-500](#) [ADRV9008BBCZ-1](#) [AD9864BCPZ](#) [AD9864BCPZRL](#) [ADAR2004ACCZ](#) [AD9874ABST](#)
[HMC8100LP6JE](#) [LTC5556IUH#PBF](#) [BGT24MR2E6327XUMA1](#) [TDA5211](#) [MICRF011YM](#) [MAX7036GTP/V+](#) [MAX2141ETH/V+](#)
[MAX7033EUI+](#) [MAX1473EUI+T](#) [MAX1473EUI+](#) [MAX1470EUI+](#) [MAX7034AUI+](#) [MAX7034AUI/V+](#)